

# TEST REPORT

**Product Name** : Face Recognition Terminal  
**Model Number** : Edge Point  
**FCC ID** : 2AJ2B-EDGEPOINT

Prepared for : Telepower Communication Co., Ltd.  
Address : 5 Bld, Zone A, Hantian Technology Town No.17 ShenHai  
RD, Nanhai District, Foshan, China

Prepared by : EMTEK (SHENZHEN) CO., LTD.  
Address : Building 69, Majialong Industry Zone, Nanshan District,  
Shenzhen, Guangdong, China

Tel: (0755) 26954280  
Fax: (0755) 26954282

Report Number : ENS2206230216W00204R  
Date(s) of Tests : June 23, 2022 to July 19, 2022  
Date of issue : July 21, 2022

# 1 TEST RESULT CERTIFICATION

Applicant : Telepower Communication Co., Ltd.  
 Address : 5 Bld, Zone A, Hantian Technology Town No.17 ShenHai RD, Nanhai District, Foshan, China  
 Manufacturer : Telepower Communication Co., Ltd.  
 Address : 5 Bld, Zone A, Hantian Technology Town No.17 ShenHai RD, Nanhai District, Foshan, China  
 EUT : Face Recognition Terminal  
 Model Name : Edge Point  
 Trademark : **oosto**

Measurement Procedure Used:

APPLICABLE STANDARDS	
STANDARD	TEST RESULT
FCC 47 CFR Part 2, Subpart J FCC 47 CFR Part 15, Subpart E	PASS
IC RSS-GEN, Issue 5(04-2018)+A1(03-2019)+A2(02-2021) IC RSS-247 Issue 2(02-2017)	PASS

The above equipment was tested by EMTEK (SHENZHEN) CO., LTD. The test data, data evaluation, test procedures, and equipment configurations shown in this report were made in accordance with the procedures given in ANSI C63.10 (2013) and the energy emitted by the sample EUT tested as described in this report is in compliance with the requirements of FCC Rules Part 2, Part 15.407, IC RSS-247 Issue 2 and IC RSS-GEN, Issue 5.

The test results of this report relate only to the tested sample identified in this report.

Date of Test : June 23, 2022 to July 19, 2022

Prepared by :   
 Una Yu /Editor

Reviewer :   
 Joe Xia /Supervisor

Approve & Authorized Signer :   
 Lisa Wang/Manager



## Modified History

Version	Report No.	Revision Date	Summary
V1.0	ENS2206230216W00204R	/	Original Report



## TABLE OF CONTENTS

<b>1</b>	<b>TEST RESULT CERTIFICATION</b> .....	<b>2</b>
<b>2</b>	<b>EUT TECHNICAL DESCRIPTION</b> .....	<b>5</b>
<b>3</b>	<b>SUMMARY OF TEST RESULT</b> .....	<b>7</b>
<b>4</b>	<b>TEST METHODOLOGY</b> .....	<b>8</b>
4.1	GENERAL DESCRIPTION OF APPLIED STANDARDS .....	8
4.2	MEASUREMENT EQUIPMENT USED .....	8
4.3	DESCRIPTION OF TEST MODES .....	9
<b>5</b>	<b>FACILITIES AND ACCREDITATIONS</b> .....	<b>13</b>
5.1	FACILITIES .....	13
5.2	EQUIPMENT .....	13
5.3	LABORATORY ACCREDITATIONS AND LISTINGS .....	13
<b>6</b>	<b>TEST SYSTEM UNCERTAINTY</b> .....	<b>14</b>
<b>7</b>	<b>SETUP OF EQUIPMENT UNDER TEST</b> .....	<b>15</b>
7.1	RADIO FREQUENCY TEST SETUP .....	15
7.2	RADIO FREQUENCY TEST SETUP .....	15
7.3	CONDUCTED EMISSION TEST SETUP .....	17
7.4	BLOCK DIAGRAM CONFIGURATION OF TEST SYSTEM .....	18
7.5	SUPPORT EQUIPMENT .....	18
<b>8</b>	<b>TEST REQUIREMENTS</b> .....	<b>19</b>
8.1	ON TIME AND DUTY CYCLE .....	19
8.2	BANDWIDTH MEASUREMENT .....	41
8.3	MAXIMUM CONDUCTED OUTPUT POWER .....	92
8.4	MAXIMUM PEAK POWER DENSITY .....	115
8.5	UNDESIRABLE RADIATED SPURIOUS EMISSION .....	139
8.6	POWER LINE CONDUCTED EMISSIONS .....	168
8.7	ANTENNA APPLICATION .....	171

## 2 EUT TECHNICAL DESCRIPTION

Characteristics	Description
<b>Product:</b>	Face Recognition Terminal
<b>Model Number:</b>	Edge Point
<b>Sample Number:</b>	2#
<b>Wifi Type:</b>	Wifi 5G with 5150MHz-5250MHz Band Wifi 5G with 5250MHz-5350MHz Band Wifi 5G with 5470MHz-5725MHz Band Wifi 5G with 5725MHz-5850MHz Band
<b>WLAN Supported:</b>	802.11a/n/ac
<b>Data Rate :</b>	802.11a: 54/48/36/24/18/12/9/6Mbps 802.11n: MCS0-MCS15 802.11ac: MCS0-MCS9
<b>Modulation:</b>	OFDM with BPSK/QPSK/16QAM/64QAM for 802.11a/n OFDM with BPSK/QPSK/16QAM/64QAM/256QAM for 802.11ac
<b>Frequency Range:</b>	UNII-1: 5150MHz-5250MHz Band  5180-5240MHz for 802.11a/n(HT20)/ac(VHT20); 5190-5230MHz for 802.11n(HT40)/ac(VHT40); 5210MHz for 802.11ac(VHT80);
	UNII-2A: 5250MHz-5350MHz Band  5260-5320MHz for 802.11a/n(HT20)/ac(VHT20); 5270-5310MHz for 802.11n(HT40)/ac(VHT40); 5290MHz for 802.11ac(VHT80);
	UNII-2C: 5470MHz-5725MHz Band  5500-5700MHz for 802.11a/n(HT20)/ac(VHT20); 5510-5670MHz for 802.11n(HT40)/ac(VHT40); 5530MHz for 802.11ac(VHT80);
	UNII-3 with 5725MHz-5850MHz Band  5745-5825MHz for 802.11a/n(HT20)/ac(VHT20); 5755-5795MHz for 802.11n(HT40)/ac(VHT40); 5775MHz for 802.11ac(VHT80);
<b>TPC Function:</b>	Not Applicable
<b>Antenna Type:</b>	FPC Antenna
<b>Antenna Gain:</b>	ANT 1: 4.60 dBi

<b>Transmit Power:</b>	UNII-1 Band: 17.75 dBm UNII-2A Band: 17.42 dBm UNII-2C Band: 16.75 dBm UNII-3 Band: 16.30 dBm
<b>Power Supply:</b>	DC12V from adapter
<b>Adapter:</b>	Model: BI24-120200-AdU Input: AC100-240, 50Hz/60Hz,0.8A Output: DC12V,2.0A
<b>Date of Received:</b>	June 23, 2022
<b>Temperature Range:</b>	-10°C ~ +45°C

**Note:** For more details, please refer to the User's manual of the EUT.



### 3 SUMMARY OF TEST RESULT

FCC Part Clause	IC Part Clause	Test Parameter	Verdict	Remark
15.407 (a) 15.407 (e) 2.1049	RSS-247 6.2 RSS-Gen 6.7	99%, 6dB and 26dB Bandwidth	PASS	
15.407 (a)	RSS-247 6.2	Maximum Conducted Output Power	PASS	
15.407 (a)	RSS-247 6.2	Power Spectral Density	PASS	
15.407 (b) 15.209 15.205	RSS-247 6.2 RSS-Gen 8.9 RSS-Gen 8.10 RSS-Gen 6.13	Radiated Spurious Emission	PASS	
15.407(g)	RSS-GEN 6.11 RSS-GEN 8.11	Frequency Stability	PASS	
15.207	RSS-Gen 8.8	Power Line Conducted Emission	PASS	
15.407(a) 15.203	RSS-Gen 6.8	Antenna Application	PASS	
NOTE1: N/A (Not Applicable)				
NOTE2: According to FCC OET KDB 789033, the report use radiated measurements in the restricted frequency bands. In addition, the radiated test is also performed to ensure the emissions emanating from the device cabinet also comply with the applicable limits.				

RELATED SUBMITTAL(S) / GRANT(S):

This submittal(s) (test report) is intended for **FCC ID: 2AJ2B-EDGEPOINT** filing to comply with Section 15.247 of the FCC Part 15, Subpart C Rules.

## 4 TEST METHODOLOGY

### 4.1 GENERAL DESCRIPTION OF APPLIED STANDARDS

According to its specifications, the EUT must comply with the requirements of the following standards:

FCC 47 CFR Part 2, Subpart J

FCC 47 CFR Part 15, Subpart E

IC RSS-GEN, Issue 5(04-2018)+A1(03-2019)+A2(02-2021)

IC RSS-247 Issue 2(02-2017)

FCC KDB 662911 D01 Multiple Transmitter Output v02r01

FCC KDB 789033 D2 General UNII Test Procedures New Rules v02r01

### 4.2 MEASUREMENT EQUIPMENT USED

#### Conducted Emission Test Equipment

Equipment	Manufacturer	Model No.	Serial No.	Last Cal.	Cal. Interval
Test Receiver	Rohde & Schwarz	ESCI	101384	May 14, 2022	1 Year
L.I.S.N.	Rohde & Schwarz	ENV216	5	May 14, 2022	1 Year
L.I.S.N.	Kyoritsu	KNW-407	8-1492-9	May 15, 2022	1 Year

#### For Spurious Emissions Test

Equipment	Manufacturer	Model No.	Serial No.	Last Cal.	Cal. Interval
EMI Test Receiver	Rohde & Schwarz	ESU 26	100154	May 14, 2022	1 Year
Pre-Amplifie	Lunar EM	LNA30M3G-25	J10100000070	May 14, 2022	1 Year
Bilog Antenna	Schwarzbeck	VULB9163	661	Jun. 12, 2021	2 Year
Horn antenna	Schwarzbeck	BBHA9120D	9120D-1177	Jun. 12, 2021	2 Year
Pre-Amplifie	SKET	LNPA_0118G-45	SK2019051801	May 14, 2022	1 Year
Loop Antenna	Schwarzbeck	FMZB1519	1519-012	Jun. 12, 2021	2 Year
Spectrum Analyzer	Rohde & Schwarz	FSV40	100967	May 14, 2022	1 Year
Horn antenna	Schwarzbeck	BBHA9120D	9120D-1178	Aug. 22, 2021	2 Year
Band reject Filter(50dB)	WI/DE	WRCGV-2400(2400-2485MHz)	2	May 14, 2022	1 Year

#### For other test items:

Equipment	Manufacturer	Model No.	Serial No.	Last Cal.	Cal. Interval
Wireless Connectivity Tester	R&S	CMW270	102543	Aug. 27, 2021	1Year
Automatic Control Unit	Tonscend	JS0806-2	2118060480	Nov. 18, 2021	1Year
Signal Analyzer	KEYSIGHT	N9010B	MY60242456	Jan. 21, 2022	1Year
Analog Signal Generator	KEYSIGHT	N5173B	MY61252625	Oct. 29, 2021	1Year
UP/DOWN-Converter	R&S	CMW-Z800A	100274	Sep. 14, 2021	1Year
Vector Signal Generator	KEYSIGHT	N5182B	MY61252674	Oct. 28, 2021	1Year
Frequency Extender	KEYSIGHT	N5182BX07	MY59362541	Nov. 23, 2021	1Year
Temperature&Humidity test chamber	ESPEC	EL-02KA	12107166	Jul. 02, 2022	1 Year



### 4.3 DESCRIPTION OF TEST MODES

The EUT has been tested under its typical operating condition.

The EUT configuration for testing is installed on RF field strength measurement to meet the Commissions requirement and operating in a manner which intends to maximize its emission characteristics in a continuous normal application.

The Transmitter was operated in the normal operating mode. The TX frequency was fixed which was for the purpose of the measurements.

Test of channel included the lowest and middle and highest frequency to perform the test, then record on this report.

Those data rates (802.11a: 54 Mbps; 802.11n(HT20): MCS0; 802.11ac(VHT20): MCS0; 802.11n(HT40): MCS0; 802.11ac(VHT40): MCS0; 802.11ac(VHT80): MCS0;) were used for all test.

Pre-defined engineering program for regulatory testing used to control the EUT for staying in continuous transmitting and receiving mode is programmed.

Wifi 5G with U-NII - 1

Frequency and Channel list for 802.11a, 802.11n (HT20), 802.11ac (VHT20):

Channel	Frequency (MHz)	Channel	Frequency (MHz)	Channel	Frequency (MHz)
36	5180	44	5220		
40	5200	48	5240		

Frequency and Channel list for 802.11n (HT40), 802.11ac (VHT40):

Channel	Frequency (MHz)	Channel	Frequency (MHz)	Channel	Frequency (MHz)
38	5190	46	5230		

Frequency and Channel list for 802.11ac (VHT80):

Channel	Frequency (MHz)	Channel	Frequency (MHz)	Channel	Frequency (MHz)
42	5210				

Test Frequency and Channel for 802.11a, 802.11n (HT20), 802.11ac (VHT20):

Lowest Frequency		Middle Frequency		Highest Frequency	
Channel	Frequency (MHz)	Channel	Frequency (MHz)	Channel	Frequency (MHz)
36	5180	40	5200	48	5240

Test Frequency and channel for 802.11n (HT40), 802.11ac (VHT40):

Lowest Frequency		Middle Frequency		Highest Frequency	
Channel	Frequency (MHz)	Channel	Frequency (MHz)	Channel	Frequency (MHz)
38	5190	N/A	N/A	46	5230

Test Frequency and channel for 802.11ac (VHT80):

Lowest Frequency		Middle Frequency		Highest Frequency	
Channel	Frequency (MHz)	Channel	Frequency (MHz)	Channel	Frequency (MHz)
42	5210	N/A	N/A	N/A	N/A

Wifi 5G with U-NII -2A

Frequency and Channel list 802.11a, 802.11n (HT20), 802.11ac (VHT20):

Channel	Frequency (MHz)	Channel	Frequency (MHz)	Channel	Frequency (MHz)
52	5260	60	5300		
56	5280	64	5320		

Frequency and Channel list for 802.11n (HT40), 802.11ac (VHT40):

Channel	Frequency (MHz)	Channel	Frequency (MHz)	Channel	Frequency (MHz)
54	5270				
62	5310				

Frequency and Channel list for 802.11ac (VHT80):

Channel	Frequency (MHz)	Channel	Frequency (MHz)	Channel	Frequency (MHz)
58	5290				

Test Frequency and Channel for 802.11a, 802.11n (HT20), 802.11ac (VHT20):

Lowest Frequency		Middle Frequency		Highest Frequency	
Channel	Frequency (MHz)	Channel	Frequency (MHz)	Channel	Frequency (MHz)
52	5260	56	5280	64	5320

Test Frequency and channel for 802.11n (HT40), 802.11ac (VHT40):

Lowest Frequency		Middle Frequency		Highest Frequency	
Channel	Frequency (MHz)	Channel	Frequency (MHz)	Channel	Frequency (MHz)
54	5270	N/A	N/A	62	5310

Test Frequency and channel for 802.11ac (VHT80):

Lowest Frequency		Middle Frequency		Highest Frequency	
Channel	Frequency (MHz)	Channel	Frequency (MHz)	Channel	Frequency (MHz)
58	5290				

Wifi 5G with U-NII -2C

Frequency and Channel list for 802.11a, 802.11n (HT20), 802.11ac (VHT20):

Channel	Frequency (MHz)	Channel	Frequency (MHz)	Channel	Frequency (MHz)
100	5500	116	5580	132	5660
104	5520	120	5600	136	5680
108	5540	124	5620	140	5700
112	5560	128	5640		

Frequency and Channel list for 802.11n (HT40), 802.11ac (VHT40):

Channel	Frequency (MHz)	Channel	Frequency (MHz)	Channel	Frequency (MHz)
102	5510	118	5590	134	5670
110	5550	126	5630		

Frequency and Channel list for 802.11ac (VHT80):

Channel	Frequency (MHz)	Channel	Frequency (MHz)	Channel	Frequency (MHz)
106	5530	122	5610		

Test Frequency and Channel for 802.11a, 802.11n (HT20), 802.11ac (VHT20):

Lowest Frequency		Middle Frequency		Highest Frequency	
Channel	Frequency (MHz)	Channel	Frequency (MHz)	Channel	Frequency (MHz)
100	5500	120	5600	140	5700

Test Frequency and channel for 802.11n (HT40), 802.11ac (VHT40):

Lowest Frequency		Middle Frequency		Highest Frequency	
Channel	Frequency (MHz)	Channel	Frequency (MHz)	Channel	Frequency (MHz)
102	5510			134	5670

Test Frequency and channel for 802.11ac (VHT80):

Lowest Frequency		Middle Frequency		Highest Frequency	
Channel	Frequency (MHz)	Channel	Frequency (MHz)	Channel	Frequency (MHz)
106	5530				

Wifi 5G with U-NII -3

Frequency and Channel list for 802.11a, 802.11n (HT20), 802.11ac (VHT20):

Channel	Frequency (MHz)	Channel	Frequency (MHz)	Channel	Frequency (MHz)
149	5745	157	5785	165	5825
153	5765	161	5805		

Frequency and Channel list for 802.11n (HT40), 802.11ac (VHT40):

Channel	Frequency (MHz)	Channel	Frequency (MHz)	Channel	Frequency (MHz)
151	5755	159	5795		

Frequency and Channel list for 802.11ac (VHT80):

Channel	Frequency (MHz)	Channel	Frequency (MHz)	Channel	Frequency (MHz)
155	5775				

Test Frequency and Channel for 802.11a, 802.11n (HT20), 802.11ac (VHT20):

Lowest Frequency		Middle Frequency		Highest Frequency	
Channel	Frequency (MHz)	Channel	Frequency (MHz)	Channel	Frequency (MHz)
149	5745	157	5785	165	5825

Test Frequency and channel for 802.11n (HT40), 802.11ac (VHT40):

Lowest Frequency		Middle Frequency		Highest Frequency	
Channel	Frequency (MHz)	Channel	Frequency (MHz)	Channel	Frequency (MHz)
151	5755	N/A	N/A	159	5795

Test Frequency and channel for 802.11ac (VHT80):

Lowest Frequency		Middle Frequency		Highest Frequency	
Channel	Frequency (MHz)	Channel	Frequency (MHz)	Channel	Frequency (MHz)
155	5775				

Multi-antenna correlation:

<input type="checkbox"/>	Transmit Signals are Correlated
	Directional gain = $10 \log[(10^{G1/20} + 10^{G2/20} + \dots + 10^{GN/20})^2 / N_{ANT}]$ dBi
<input type="checkbox"/>	All Transmit Signals are Completely Uncorrelated
	Directional gain = $10 \log[(10^{G1/10} + 10^{G2/10} + \dots + 10^{GN/10}) / N_{ANT}]$ dBi

## 5 FACILITIES AND ACCREDITATIONS

### 5.1 FACILITIES

All measurement facilities used to collect the measurement data are located at:

EMTEK (Shenzhen) Co., Ltd.

Building 69, Majialong Industry Zone District, Nanshan District, Shenzhen, China

The sites are constructed in conformance with the requirements of ANSI C63.7, ANSI C63.4 and CISPR Publication 22.

### 5.2 EQUIPMENT

Radiated emissions are measured with one or more of the following types of linearly polarized antennas: tuned dipole, biconical, log periodic, bi-log, and/or ridged waveguide, horn. Spectrum analyzers with preselectors and quasi-peak detectors are used to perform radiated measurements.

Conducted emissions are measured with Line Impedance Stabilization Networks and EMI Test Receivers.

Calibrated wideband preamplifiers, coaxial cables, and coaxial attenuators are also used for making measurements.

All receiving equipment conforms to CISPR Publication 16-1, "Radio Interference Measuring Apparatus and Measurement Methods."

### 5.3 LABORATORY ACCREDITATIONS AND LISTINGS

Site Description	
EMC Lab.	<p><b>Accredited by CNAS</b> The Certificate Registration Number is L2291. The Laboratory has been assessed and proved to be in compliance with CNAS-CL01 (identical to ISO/IEC 17025:2017)</p> <p><b>Accredited by FCC</b> Designation Number: CN1204 Test Firm Registration Number: 882943</p> <p><b>Accredited by A2LA</b> The Certificate Number is 4321.01.</p> <p>Accredited by Industry Canada The Conformity Assessment Body Identifier is CN0008</p>
Name of Firm	: EMTEK (SHENZHEN) CO., LTD.
Site Location	: Building 69, Majialong Industry Zone, Nanshan District, Shenzhen, Guangdong, China

## 6 TEST SYSTEM UNCERTAINTY

The following measurement uncertainty levels have been estimated for tests performed on the apparatus:

Test Parameter	Measurement Uncertainty
Radio Frequency	$\pm 1 \times 10^{-5}$
99% , 6dB and 26dB Bandwidth	$\pm 1.0\text{dB}$
Maximum Conducted Output Power	$\pm 1.0\text{dB}$
Power Spectral Density	$\pm 2.0\text{dB}$
Radiated Spurious Emission	$\pm 3.0\text{dB}$
Conducted Emissions	$\pm 2.0\text{dB}$
Temperature	$\pm 0.5^{\circ}\text{C}$
Humidity	$\pm 3\%$

Measurement Uncertainty for a level of Confidence of 95%

## 7 SETUP OF EQUIPMENT UNDER TEST

### 7.1 RADIO FREQUENCY TEST SETUP

The WLAN component's antenna ports(s) of the EUT are connected to the measurement instrument per an appropriate attenuator. The EUT is controlled by PC/software to emit the specified signals for the purpose of measurements.

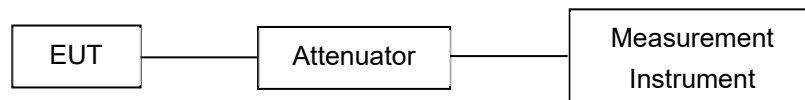

### 7.2 RADIO FREQUENCY TEST SETUP

The test site semi-anechoic chamber has met the requirement of NSA tolerance 4 dB according to the standards: ANSI C63.10. The test distance is 3m. The setup is according to the requirements in Section 13.1.4.1 of ANSI C63.10-2013 and CAN/CSA-CEI/IEC CISPR 22.

Below 30MHz:

The EUT is placed on a turntable 0.8 meters above the ground in the chamber, 3 meter away from the antenna (loop antenna). The Antenna should be positioned with its plane vertical at the specified distance from the EUT and rotated about its vertical axis for maximum response at each azimuth about the EUT. The center of the loop shall be 1 m above the ground. For certain applications, the loop antenna plane may also need to be positioned horizontally at the specified distance from the EUT.

Above 30MHz:

The EUT is placed on a turntable 0.8 meters above the ground in the chamber, 3 meter away from the antenna. The maximal emission value is acquired by adjusting the antenna height, polarisation and turntable azimuth. Normally, the height range of antenna is 1 m to 4 m, the azimuth range of turntable is 0° to 360°, and the receive antenna has two polarizations Vertical (V) and Horizontal (H).

Above 1GHz:

(Note: the FCC's permission to use 1.5m as an alternative per TCBC Conf call of Dec. 2, 2014.)

The EUT is placed on a turntable 1.5 meters above the ground in the chamber, 3 meter away from the antenna. The maximal emission value is acquired by adjusting the antenna height, polarisation and turntable azimuth. Normally, the height range of antenna is 1 m to 4 m, the azimuth range of turntable is 0° to 360°, and the receive antenna has two polarizations Vertical (V) and Horizontal (H).

(a) Radiated Emission Test Set-Up, Frequency Below 30MHz

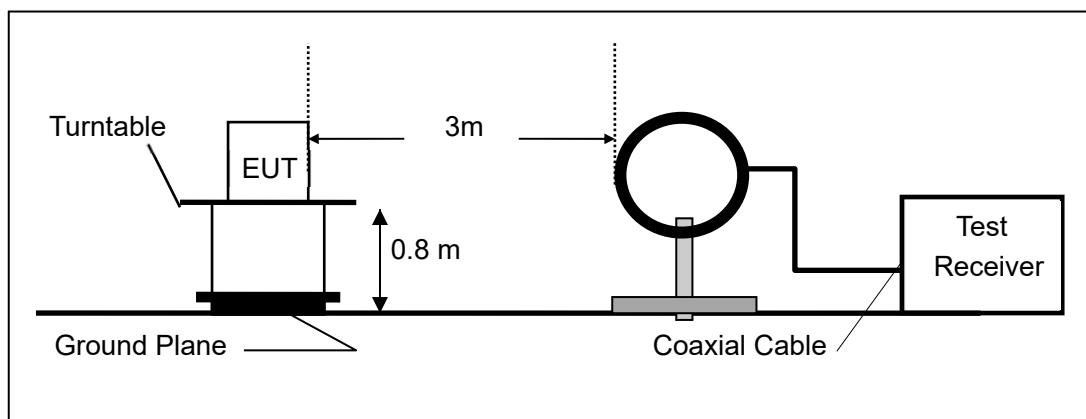

(b) Radiated Emission Test Set-Up, Frequency Below 1000MHz

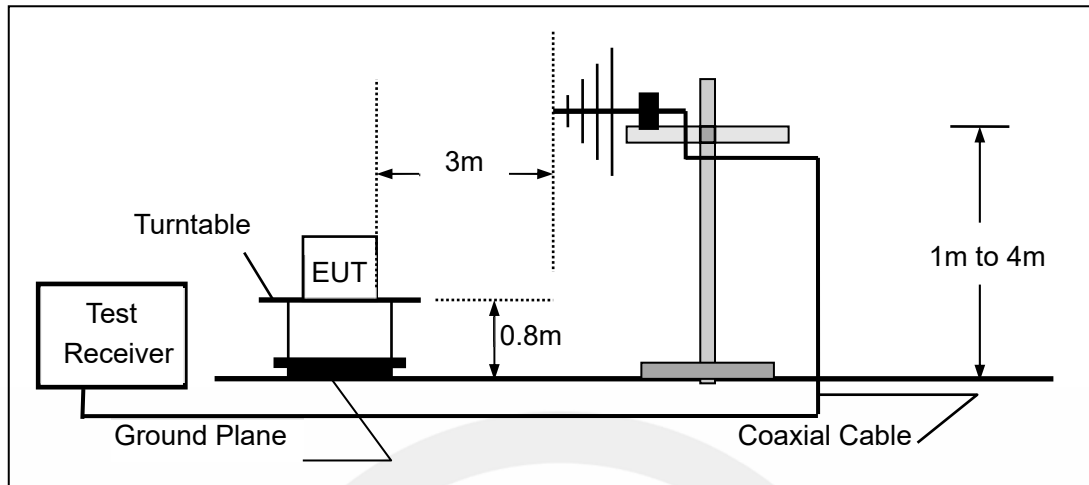

(c) Radiated Emission Test Set-Up, Frequency above 1000MHz

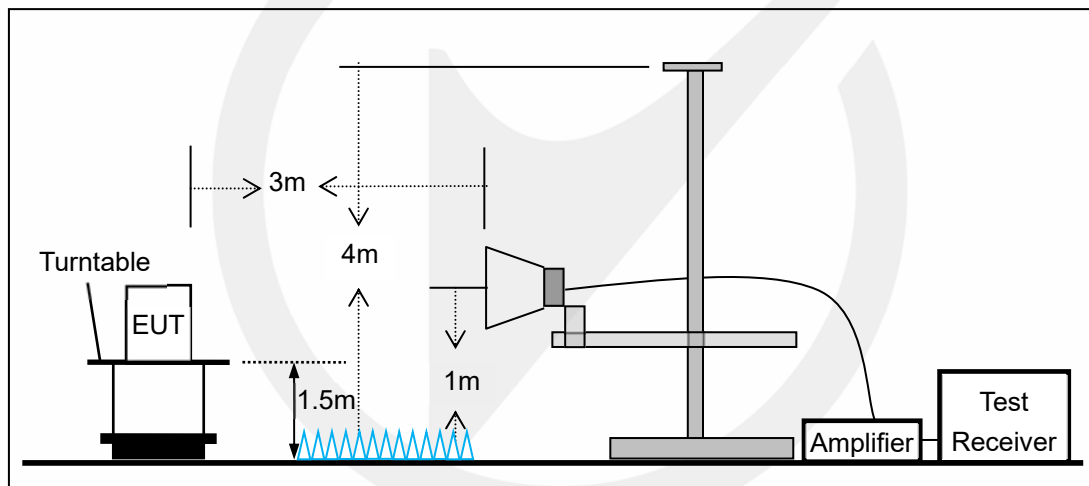



### 7.3 CONDUCTED EMISSION TEST SETUP

The mains cable of the EUT (maybe per AC/DC Adapter) must be connected to LISN. The LISN shall be placed 0.8 m from the boundary of EUT and bonded to a ground reference plane for LISN mounted on top of the ground reference plane. This distance is between the closest points of the LISN and the EUT. All other units of the EUT and associated equipment shall be at least 0.8m from the LISN.

Ground connections, where required for safety purposes, shall be connected to the reference ground point of the LISN and, where not otherwise provided or specified by the manufacturer, shall be of same length as the mains cable and run parallel to the mains connection at a separation distance of not more than 0.1 m.

According to the requirements in Section 13.1.4.1 of ANSI C63.10-2013 Conducted emissions from the EUT measured in the frequency range between 0.15 MHz and 30 MHz using CISPR Quasi-Peak and average detector mode.

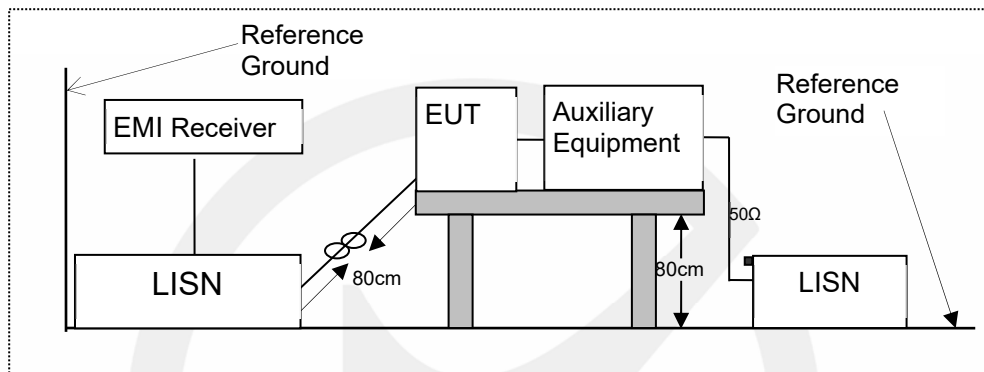

### 7.4 BLOCK DIAGRAM CONFIGURATION OF TEST SYSTEM

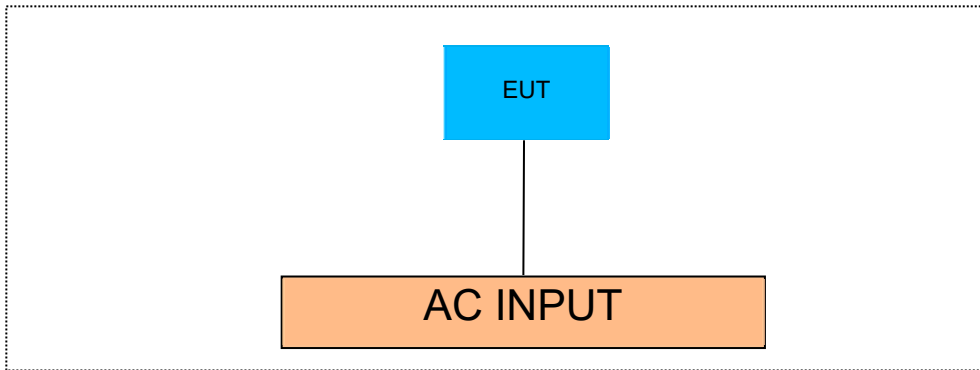

### 7.5 SUPPORT EQUIPMENT

EUT Cable List and Details			
Cable Description	Length (m)	Shielded/Unshielded	With / Without Ferrite
/	/	/	/

Auxiliary Cable List and Details			
Cable Description	Length (m)	Shielded/Unshielded	With / Without Ferrite
/	/	/	/

Auxiliary Equipment List and Details			
Description	Manufacturer	Model	Serial Number
/	/	/	/

**Notes:**

- 1.All the equipment/cables were placed in the worst-case configuration to maximize the emission during the test.
- 2.Grounding was established in accordance with the manufacturer’s requirements and conditions for the intended use.

## 8 TEST REQUIREMENTS

### 8.1 ON TIME AND DUTY CYCLE

#### 8.1.1 Applicable Standard

According to 789033 D02 Section II.B

#### 8.1.2 Conformance Limit

N/A; for reporting purposes only.

#### 8.1.3 Test Configuration

Test according to clause 7.1 radio frequency test setup.

#### 8.1.4 Test Procedure

The zero-span mode on a spectrum analyzer or EMI receiver, if the response time and spacing between bins on the sweep are sufficient to permit accurate measurements of the on and off times of the transmitted signal. Set the center frequency of the instrument to the center frequency of the transmission. Set RBW  $\geq$  EBW if possible; otherwise, set RBW to the largest available value. Set VBW  $\geq$  RBW. Set detector = peak or average. The zero-span measurement method shall not be used unless both RBW and VBW are  $> 50/T$ , where T is the minimum transmission duration over which the transmitter is on and is transmitting at its maximum power control level for the tested mode of operation), and the number of sweep points across duration T exceeds 100. (For example, if VBW and/or RBW are limited to 3 MHz, then the zero-span method of measuring duty cycle shall not be used if  $T \leq 16.7$  microseconds.)

#### 8.1.5 Test Results

Temperature:	25°C
Relative Humidity:	45%
ATM Pressure:	1011 mbar
Test Engineer:	XXH

Note: N/A

TestMode	Antenna	Frequency[MHz]	Transmission Duration [ms]	Transmission Period [ms]	Duty Cycle [%]
11A	Ant1	5180	2.06	2.10	98.10
		5220	2.07	2.10	98.57
		5240	2.07	2.10	98.57
		5260	2.06	2.10	98.10
		5300	2.06	2.10	98.10
		5320	2.06	2.10	98.10
		5500	2.07	2.11	98.10
		5580	2.07	2.10	98.57
		5700	2.06	2.10	98.10
		5745	2.06	2.10	98.10
		5785	2.06	2.10	98.10
		5825	2.07	2.10	98.57
11N20SISO	Ant1	5180	1.92	1.96	97.96
		5220	1.92	1.96	97.96
		5240	1.93	1.96	98.47
		5260	1.92	1.96	97.96
		5300	1.92	1.96	97.96
		5320	1.92	1.96	97.96
		5500	1.93	1.96	98.47
		5580	1.92	1.96	97.96

		5700	1.92	1.96	97.96
		5745	1.92	1.96	97.96
		5785	1.93	1.96	98.47
		5825	1.92	1.96	97.96
11N40SISO	Ant1	5190	0.95	0.99	95.96
		5230	0.95	0.98	96.94
		5270	0.95	0.99	95.96
		5310	0.94	0.98	95.92
		5510	0.94	0.98	95.92
		5550	0.94	0.98	95.92
		5670	0.95	0.99	95.96
		5755	0.94	0.98	95.92
		5795	0.95	0.99	95.96
11AC20SISO	Ant1	5180	1.93	1.97	97.97
		5220	1.93	1.97	97.97
		5240	1.93	1.97	97.97
		5260	1.93	1.97	97.97
		5300	1.93	1.97	97.97
		5320	1.93	1.97	97.97
		5500	1.94	1.97	98.48
		5580	1.93	1.97	97.97
		5700	1.94	1.97	98.48
		5745	1.93	1.97	97.97
		5785	1.93	1.97	97.97
		5825	1.93	1.97	97.97
11AC40SISO	Ant1	5190	0.95	0.99	95.96
		5230	0.95	0.99	95.96
		5270	0.95	0.99	95.96
		5310	0.95	0.98	96.94
		5510	0.95	0.99	95.96
		5550	0.95	0.99	95.96
		5670	0.95	0.99	95.96
		5755	0.95	0.98	96.94
		5795	0.95	0.99	95.96
11AC80SISO	Ant1	5210	0.46	0.50	92.00
		5290	0.46	0.50	92.00
		5530	0.46	0.50	92.00
		5610	0.46	0.50	92.00
		5775	0.47	0.50	94.00

## 11A\_Ant1\_5180

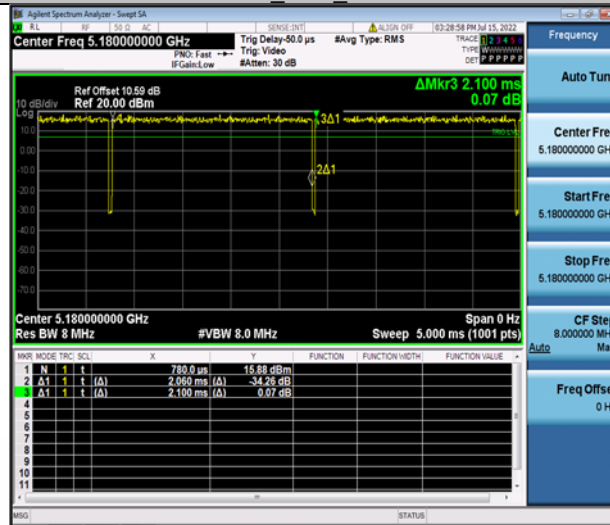

## 11A\_Ant1\_5220



## 11A\_Ant1\_5240



## 11A\_Ant1\_5260

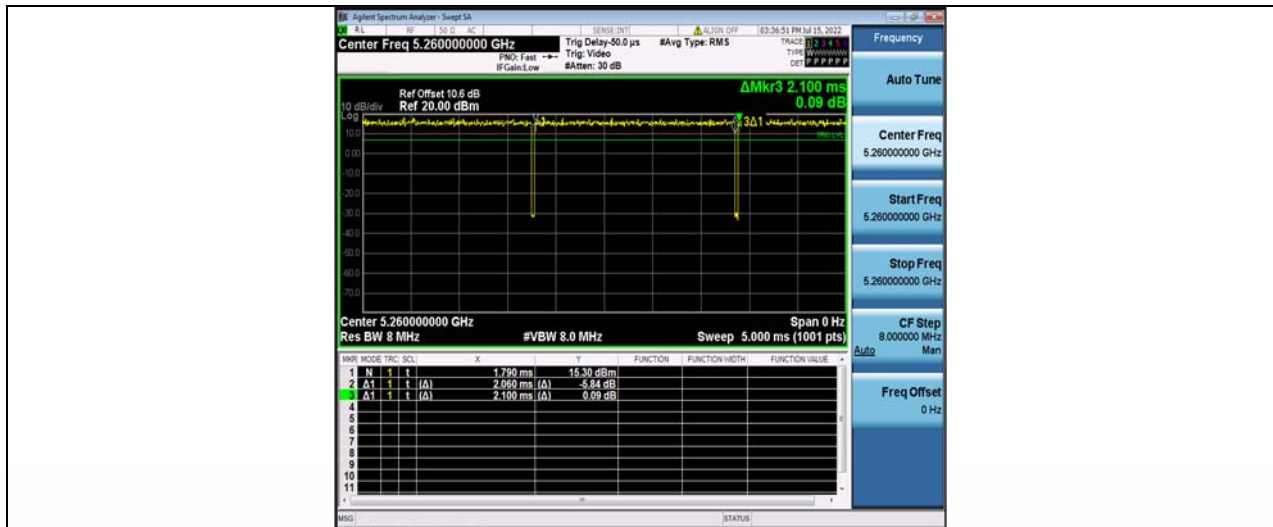

11A Ant1\_5300

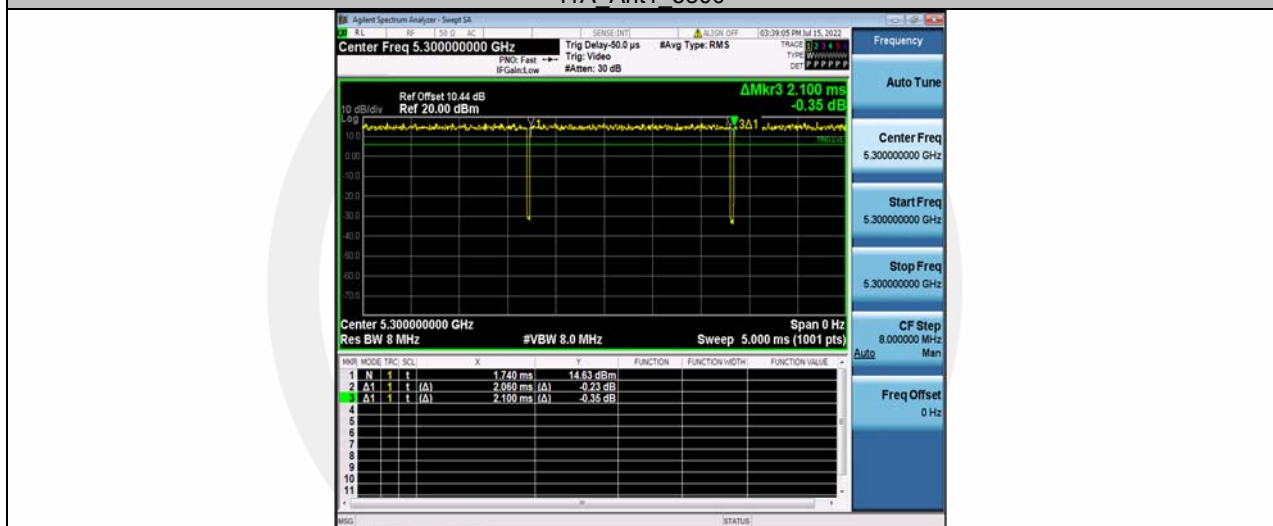

11A Ant1\_5320

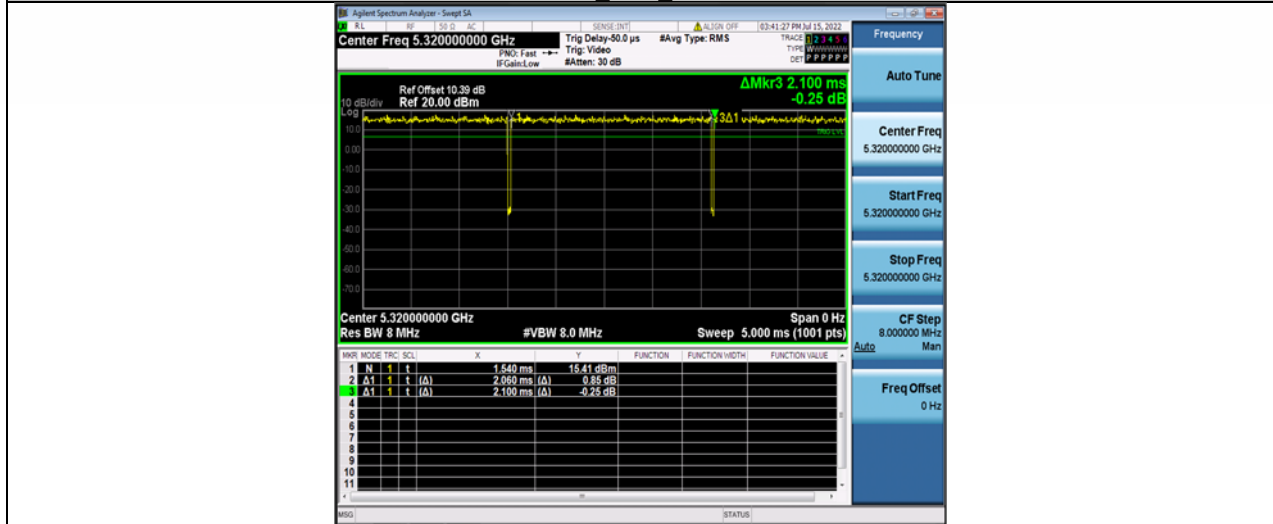

11A Ant1\_5500



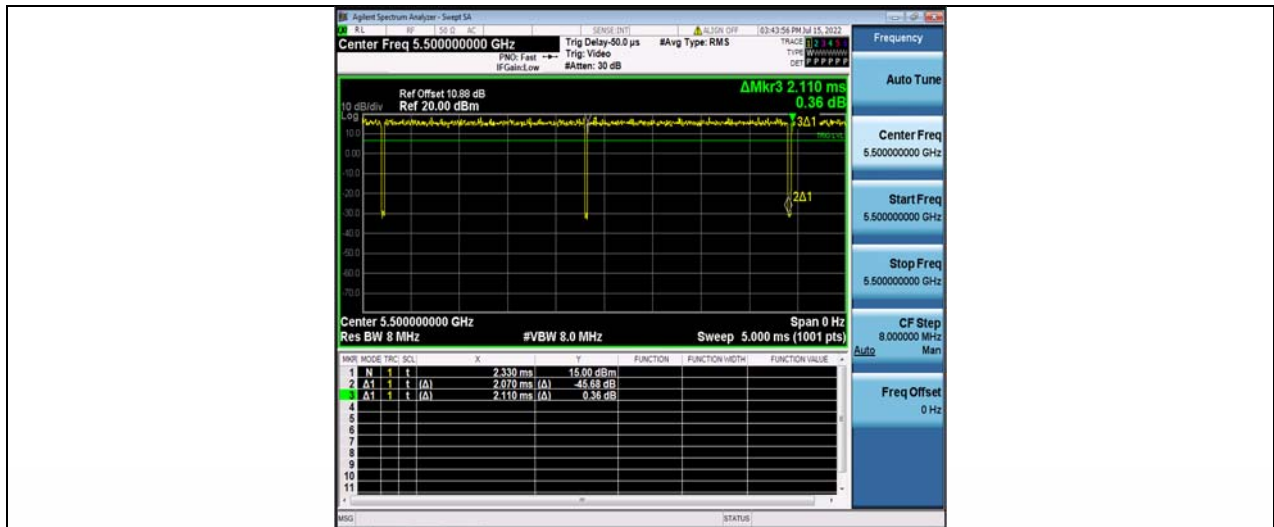

11A Ant1\_5580

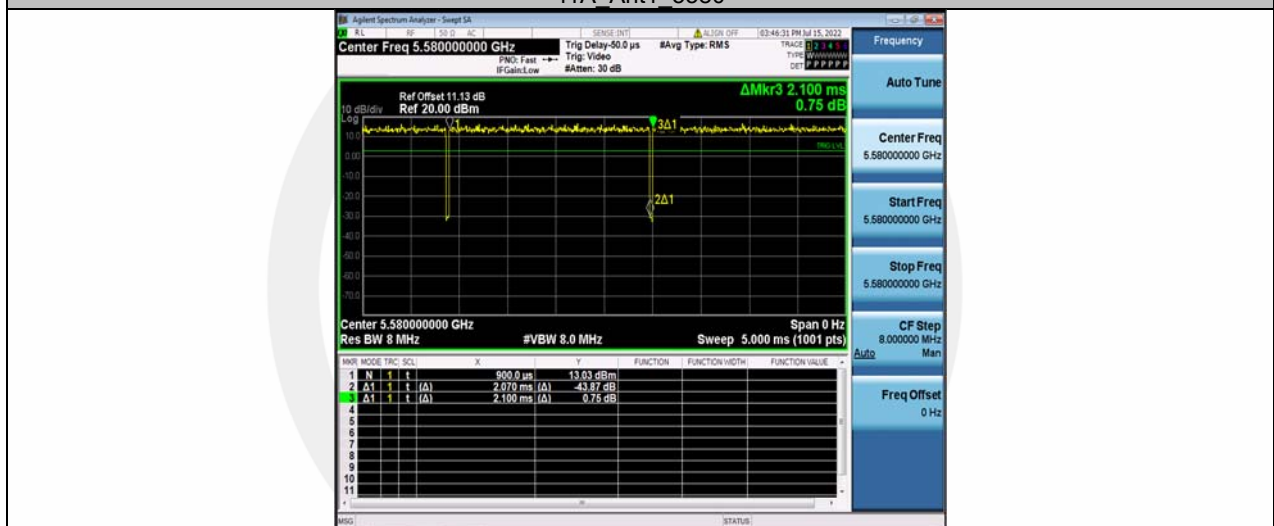

11A Ant1\_5700

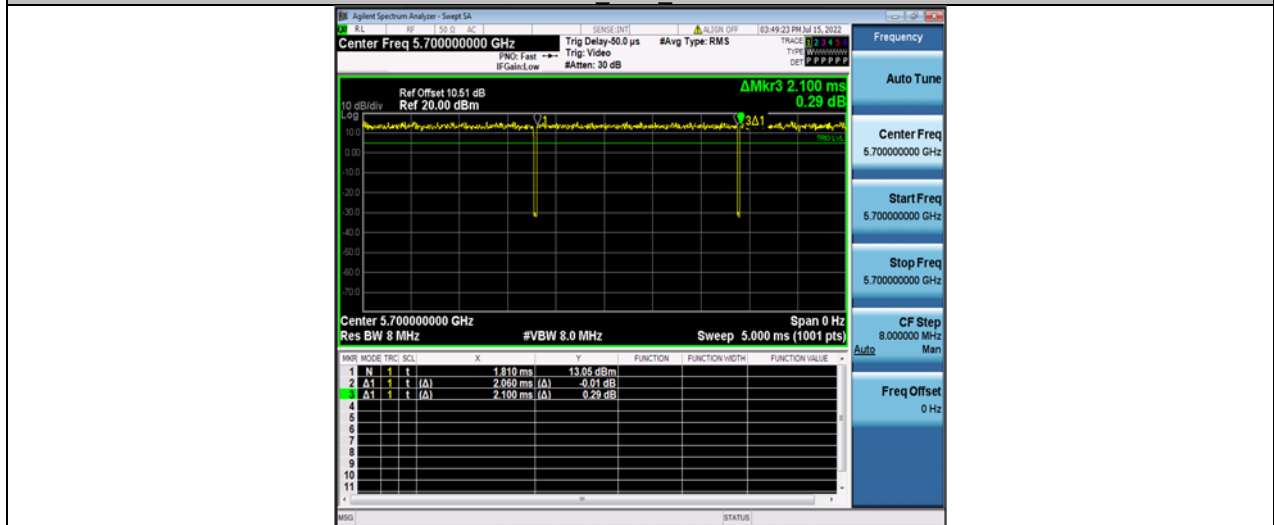

11A Ant1\_5745

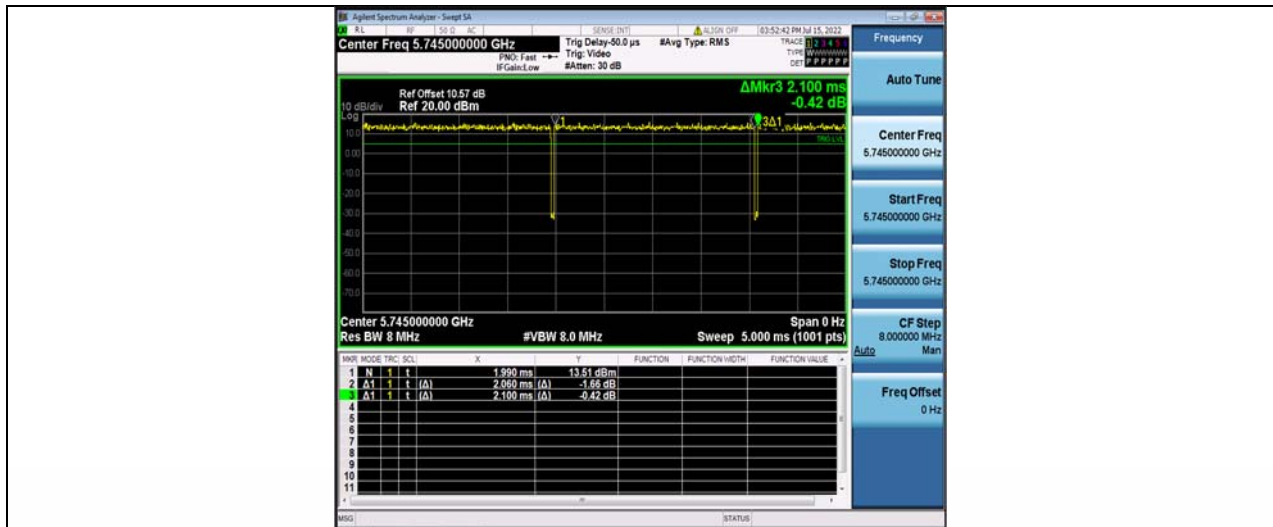

11A Ant1\_5785

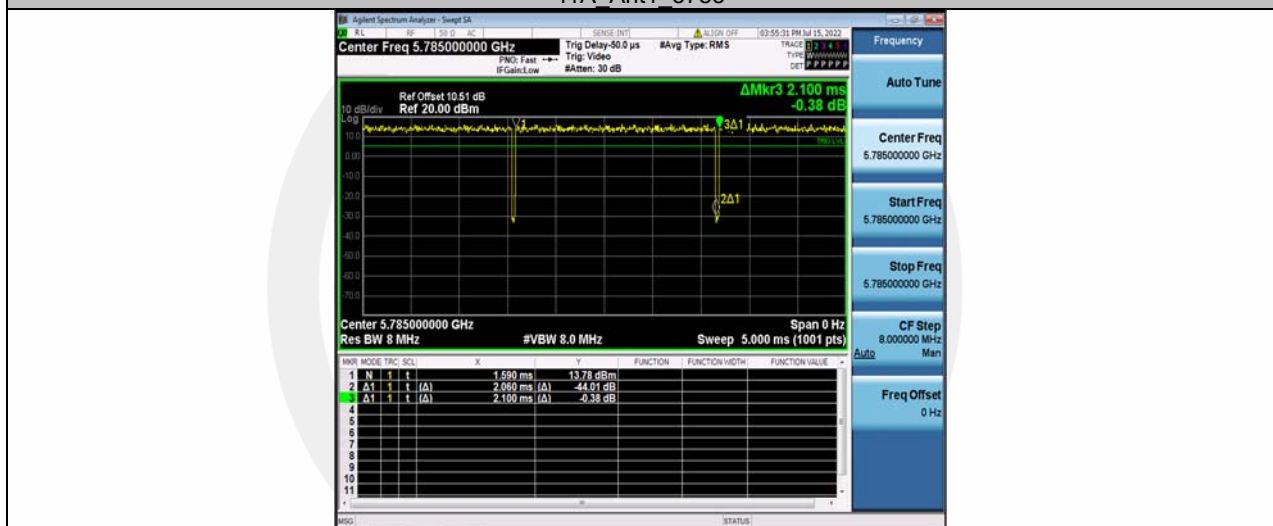

11A Ant1\_5825

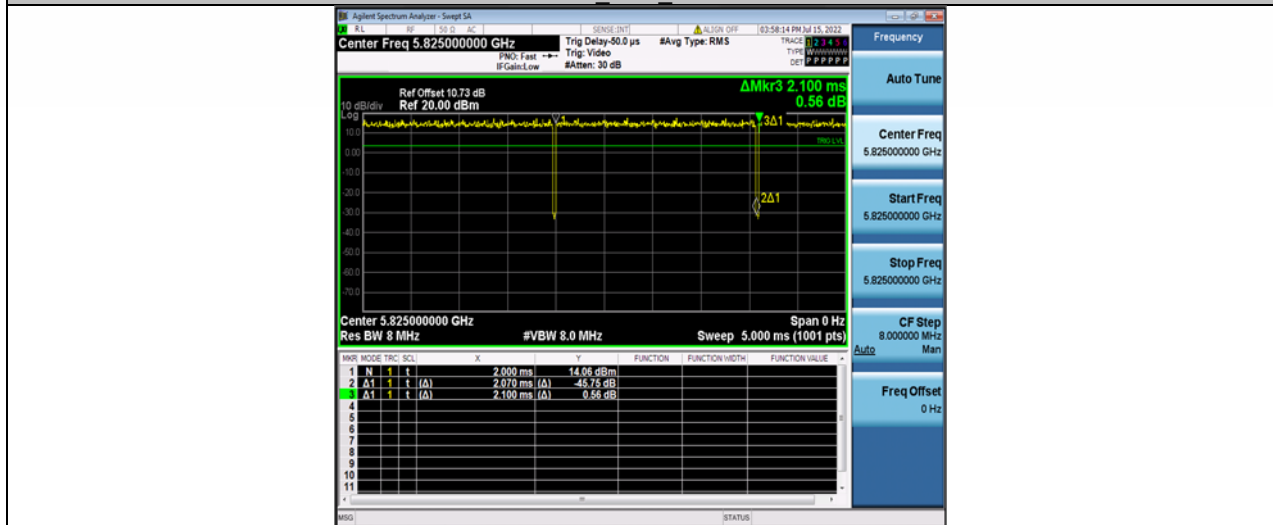

11N20SISO Ant1\_5180



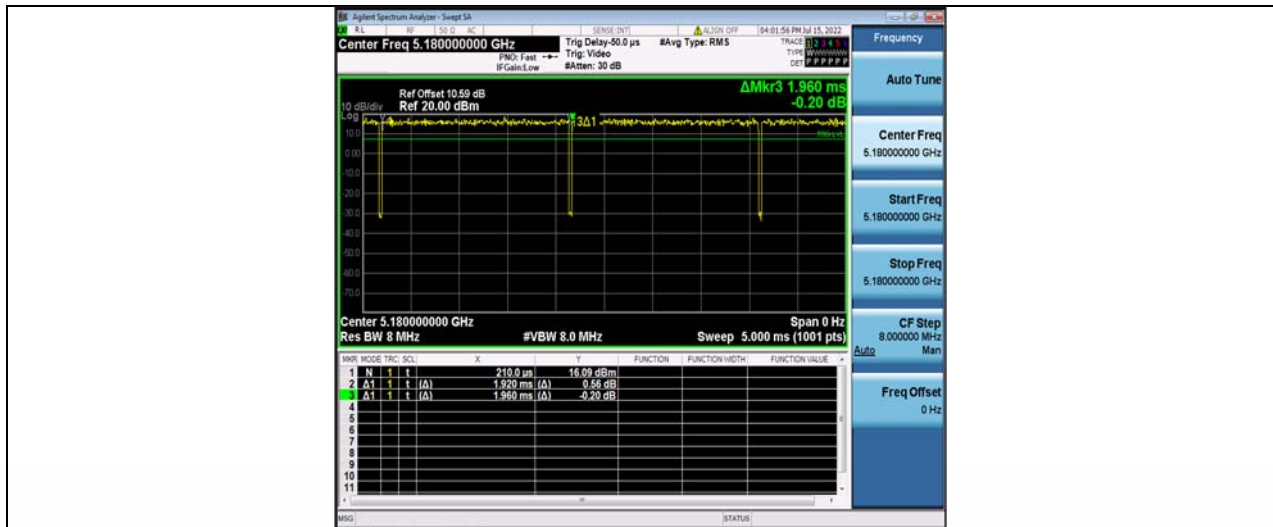

11N20SISO Ant1 5220

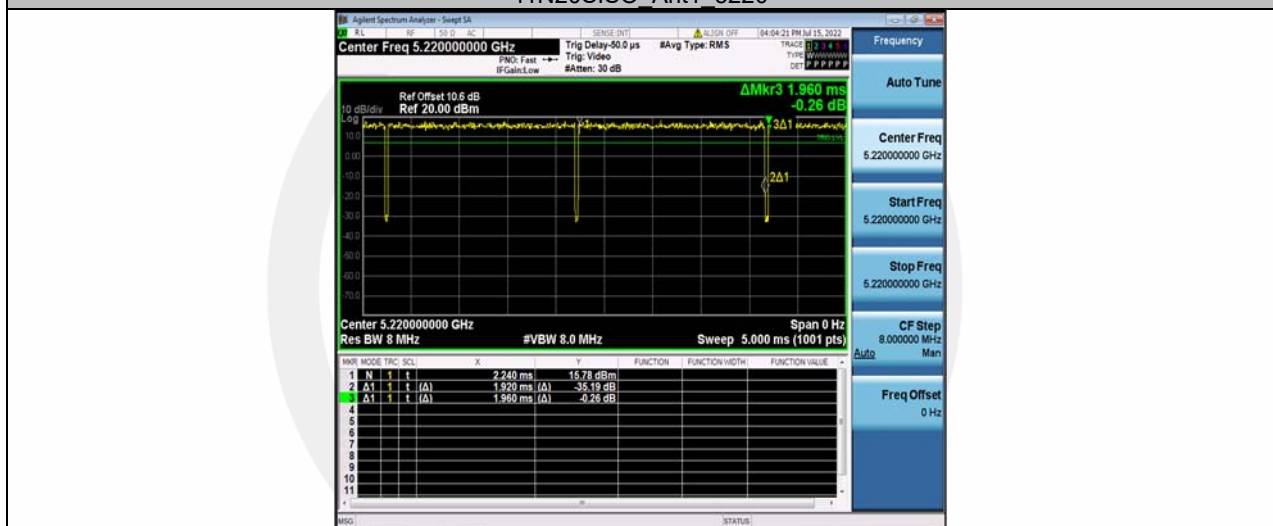

11N20SISO Ant1 5240

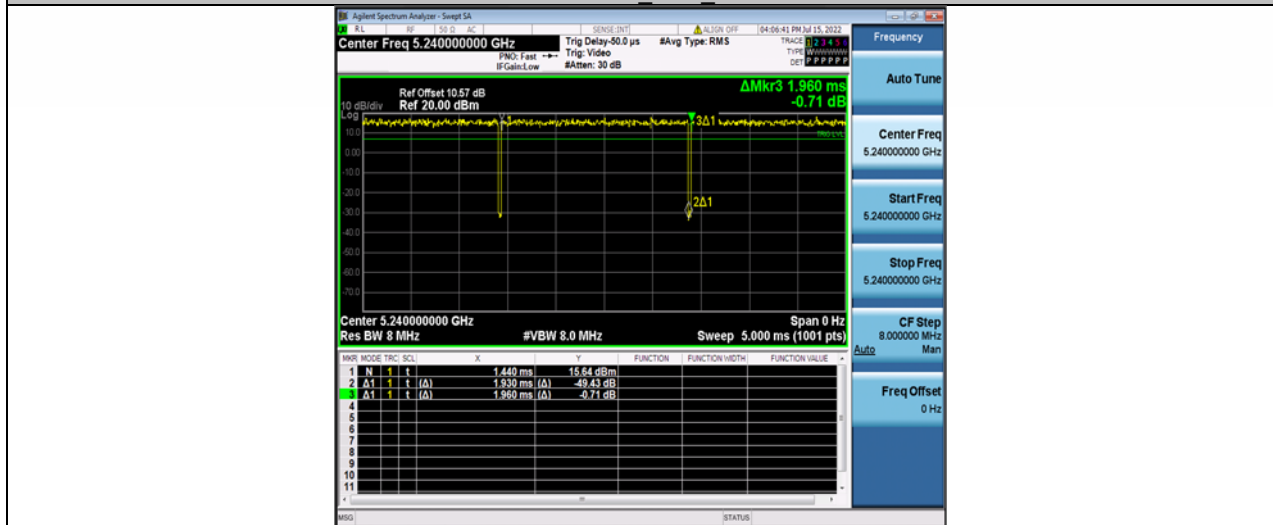

11N20SISO Ant1 5260

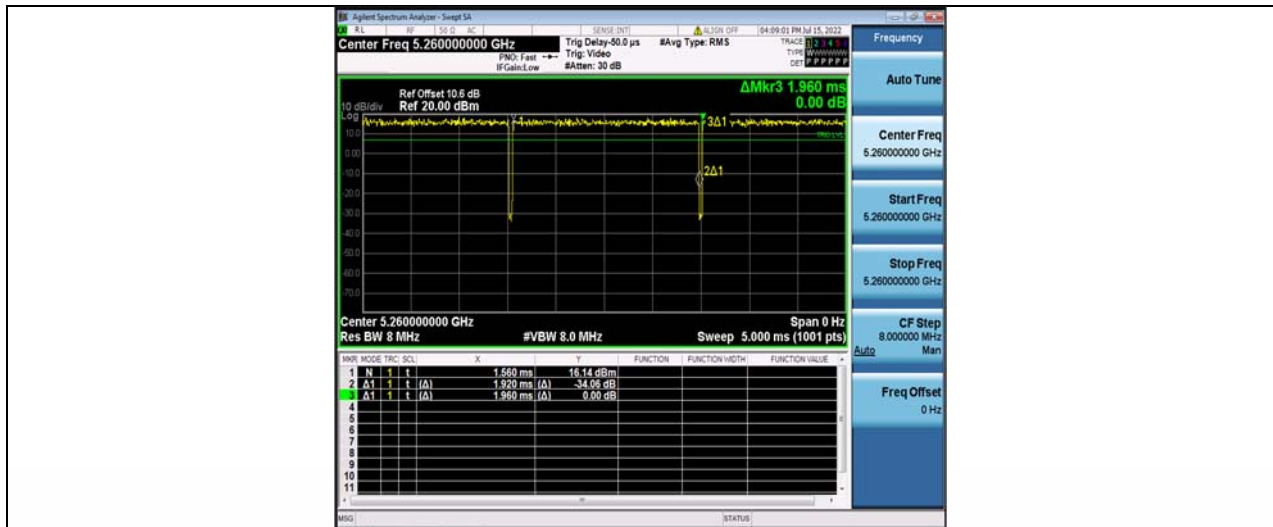

11N20SISO Ant1 5300

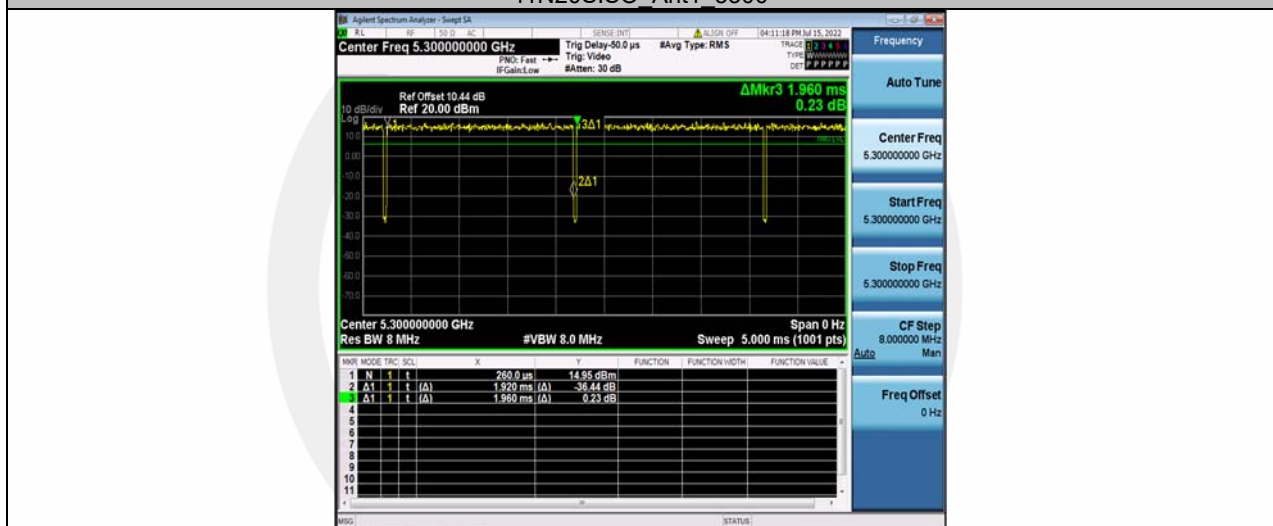

11N20SISO Ant1 5320

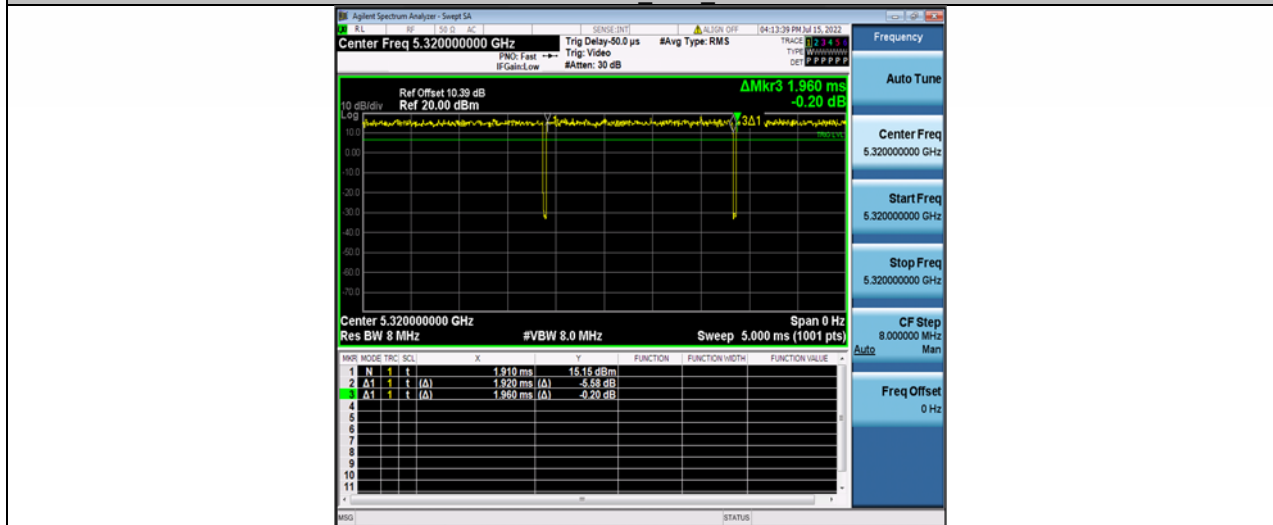

11N20SISO Ant1 5500

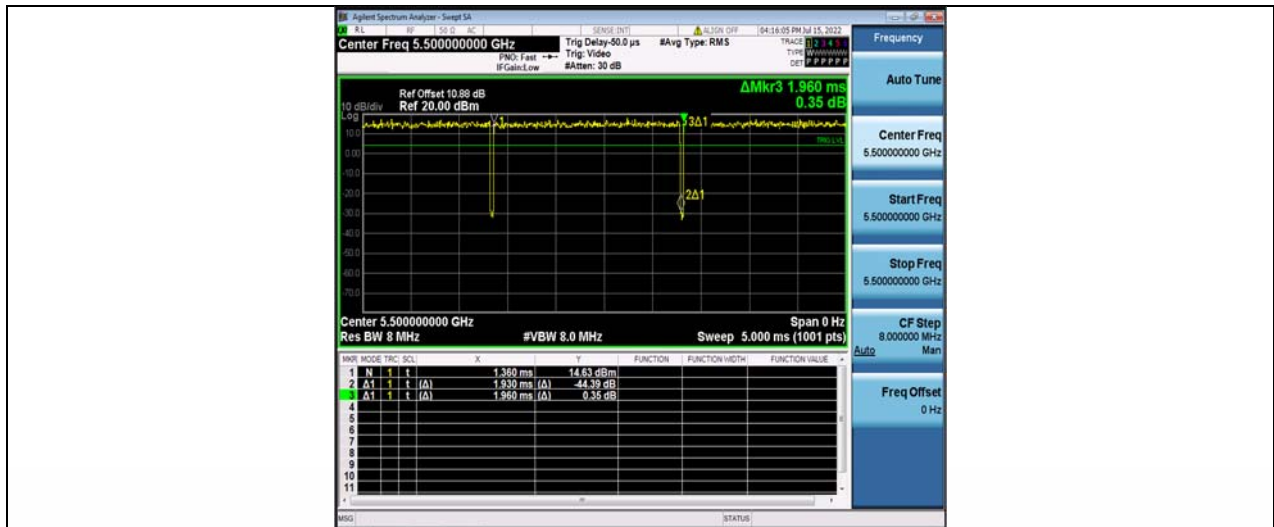

11N20SISO Ant1 5580

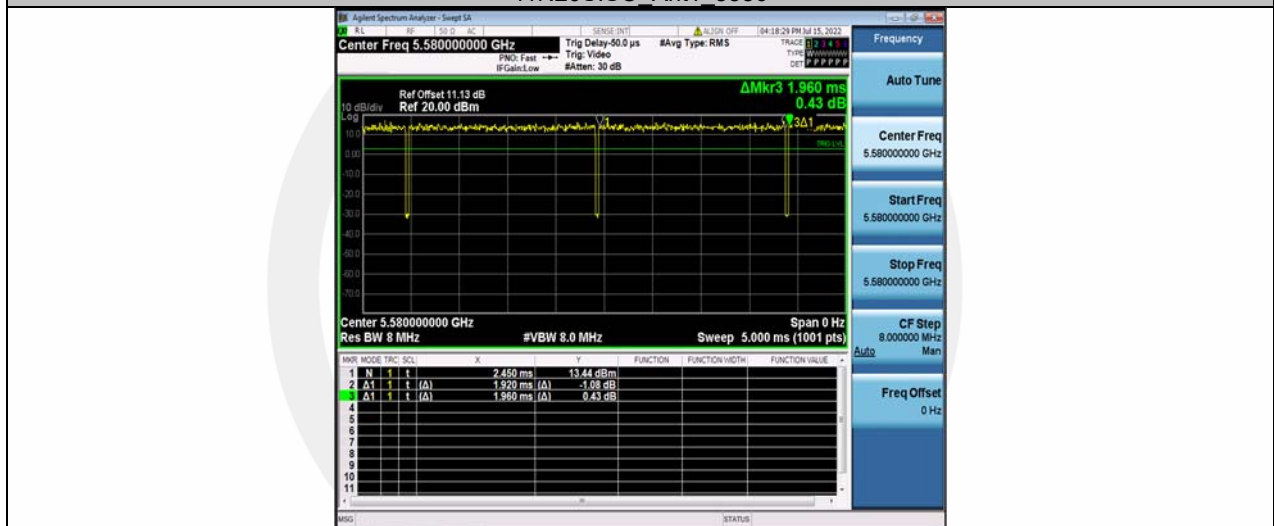

11N20SISO Ant1 5700

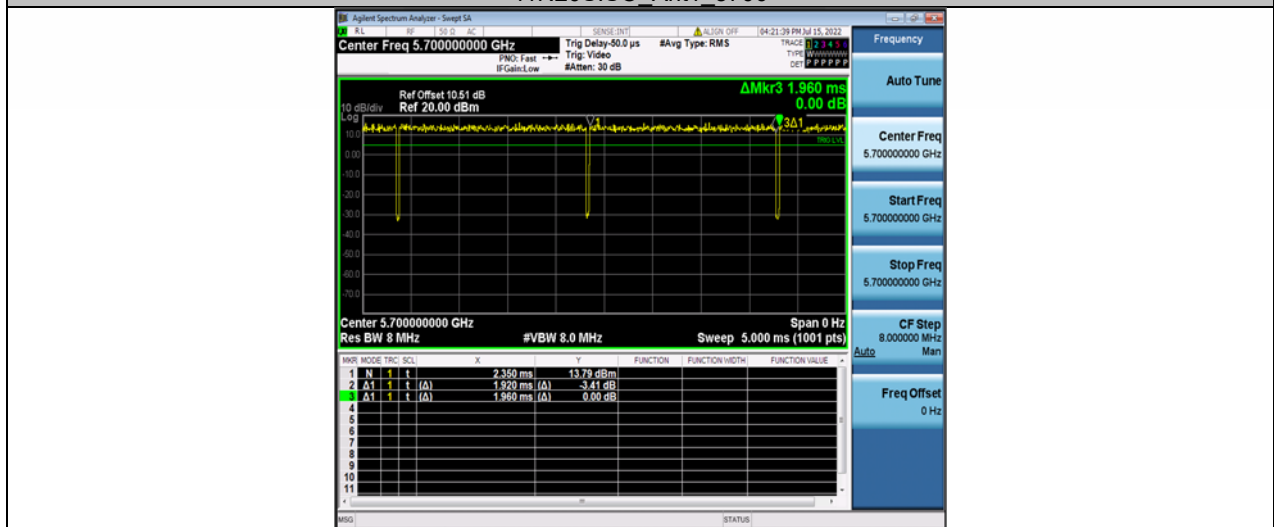

11N20SISO Ant1 5745

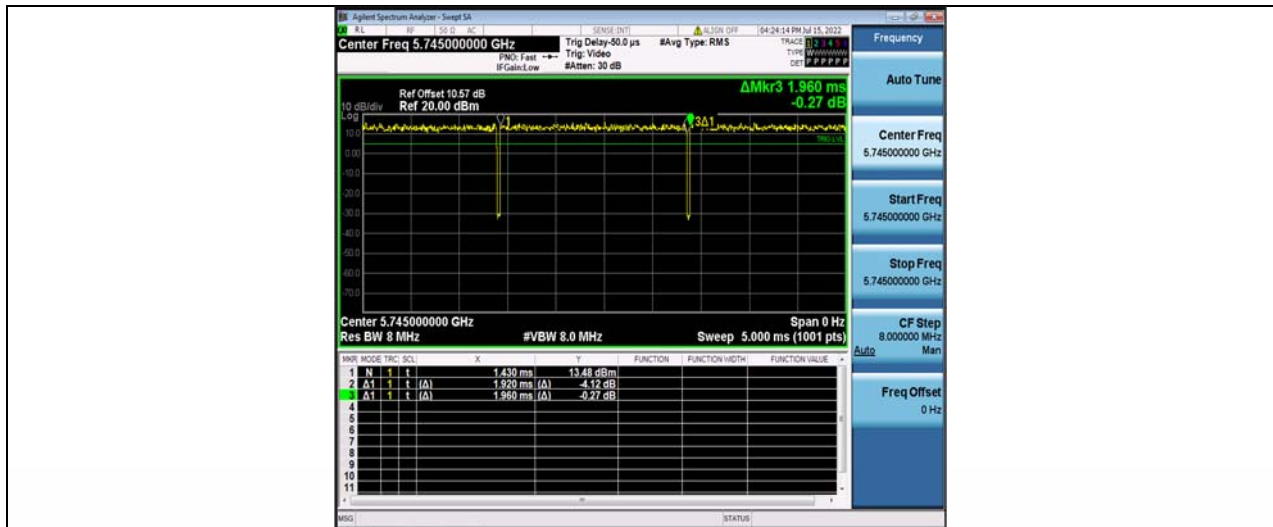

11N20SISO Ant1 5785

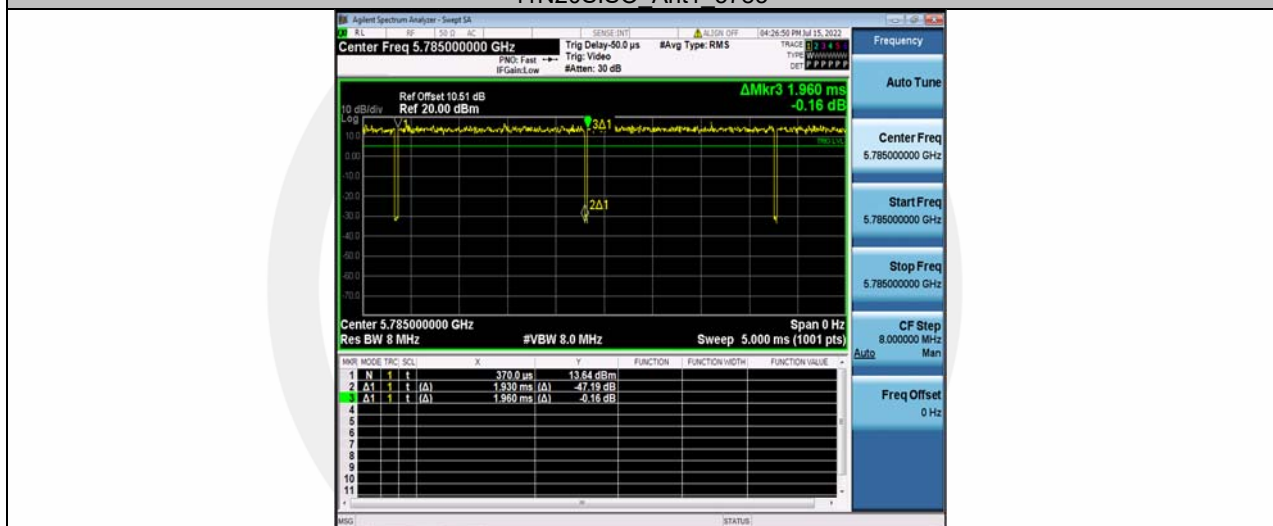

11N20SISO Ant1 5825

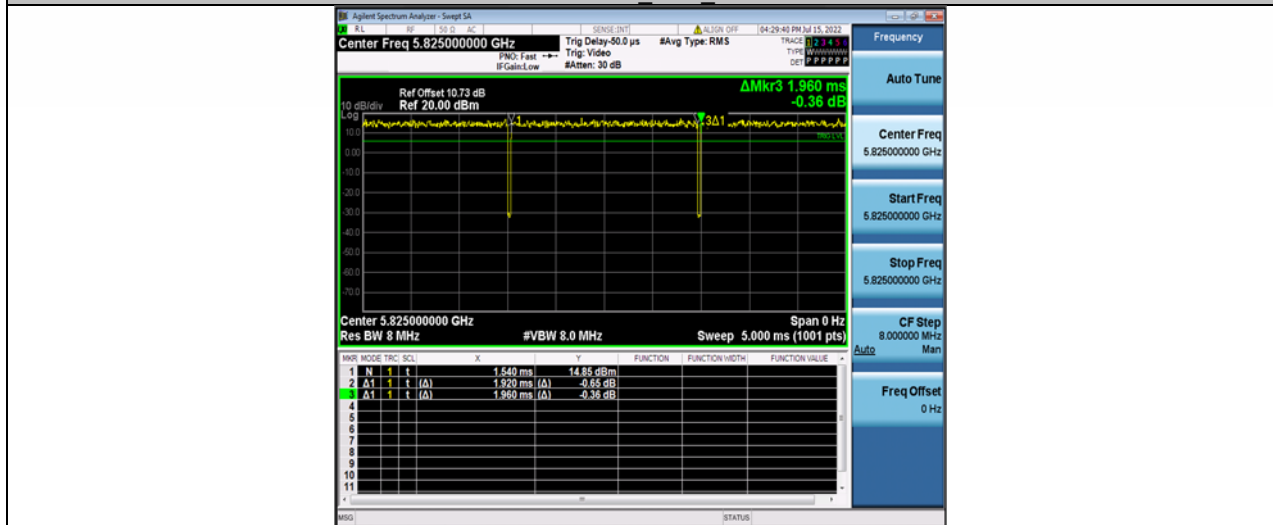

11N40SISO Ant1 5190



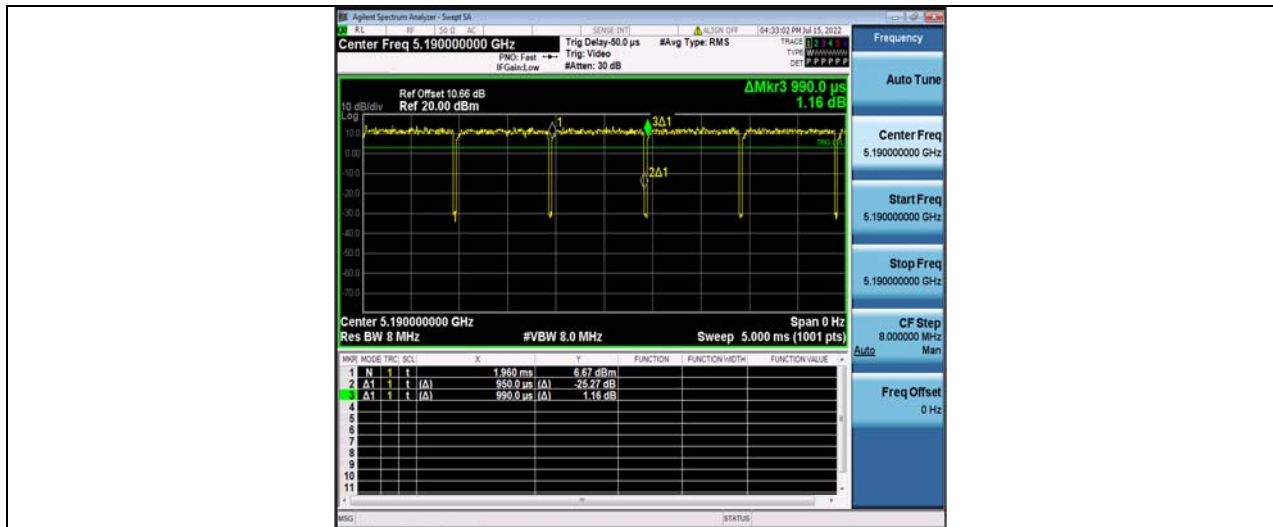

11N40SISO Ant1 5230

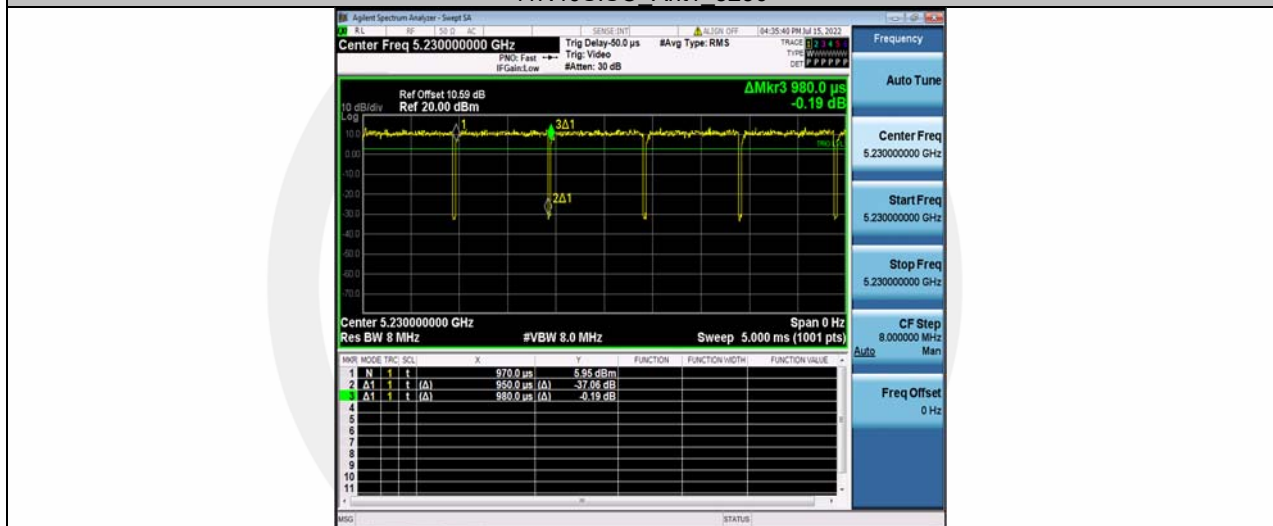

11N40SISO Ant1 5270

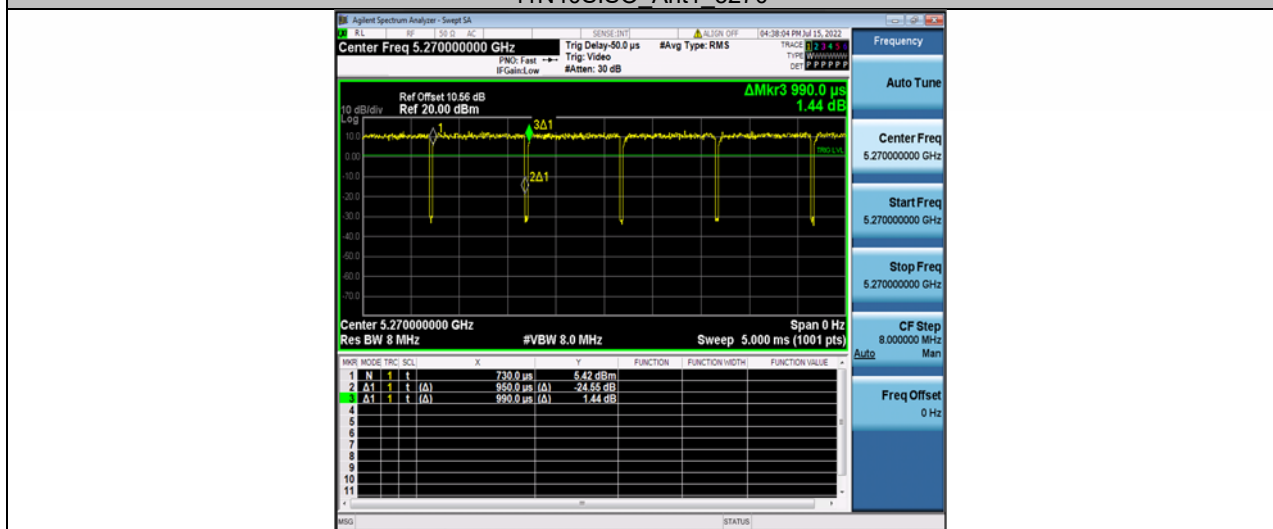

11N40SISO Ant1 5310

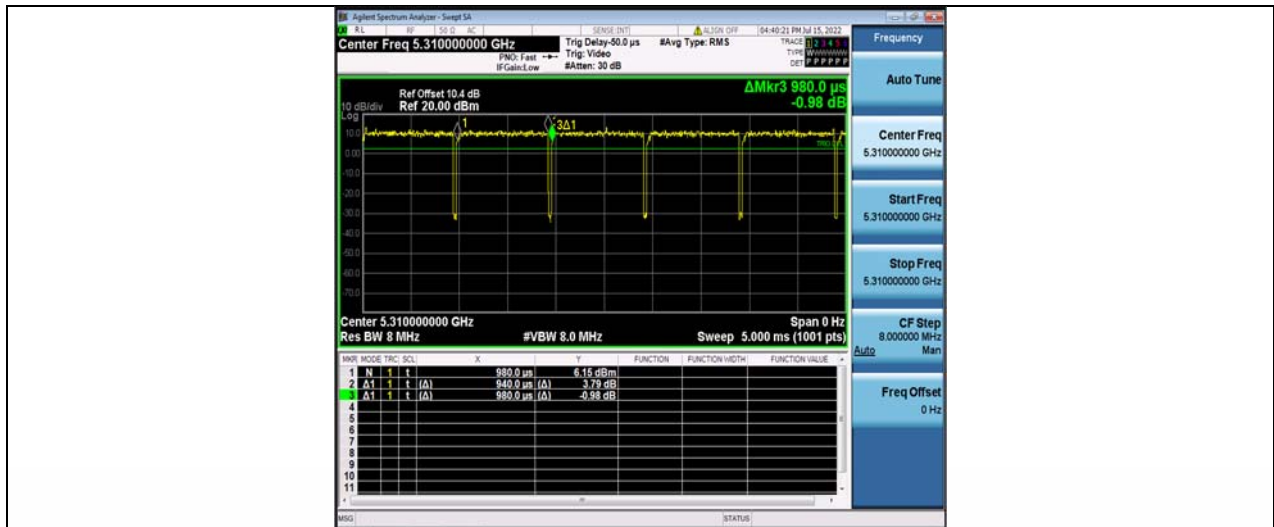

11N40SISO Ant1 5510

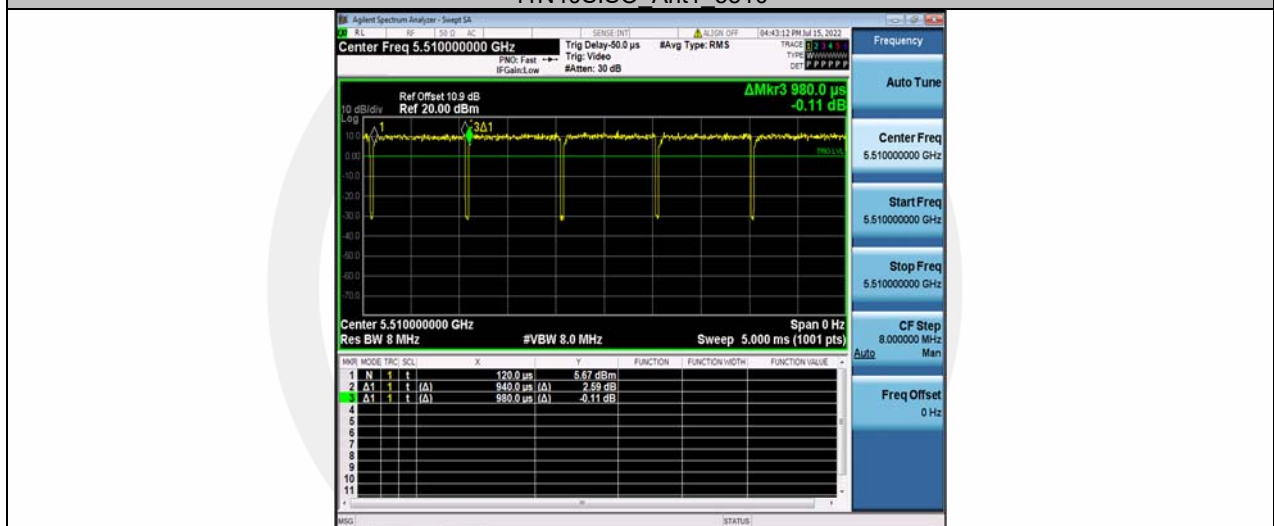

11N40SISO Ant1 5550

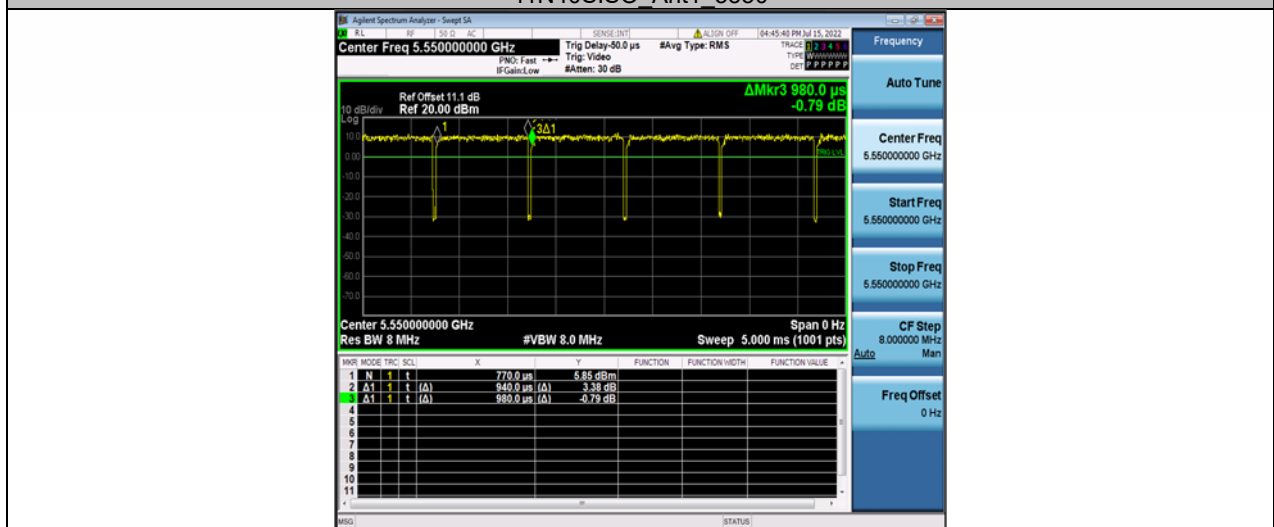

11N40SISO Ant1 5670

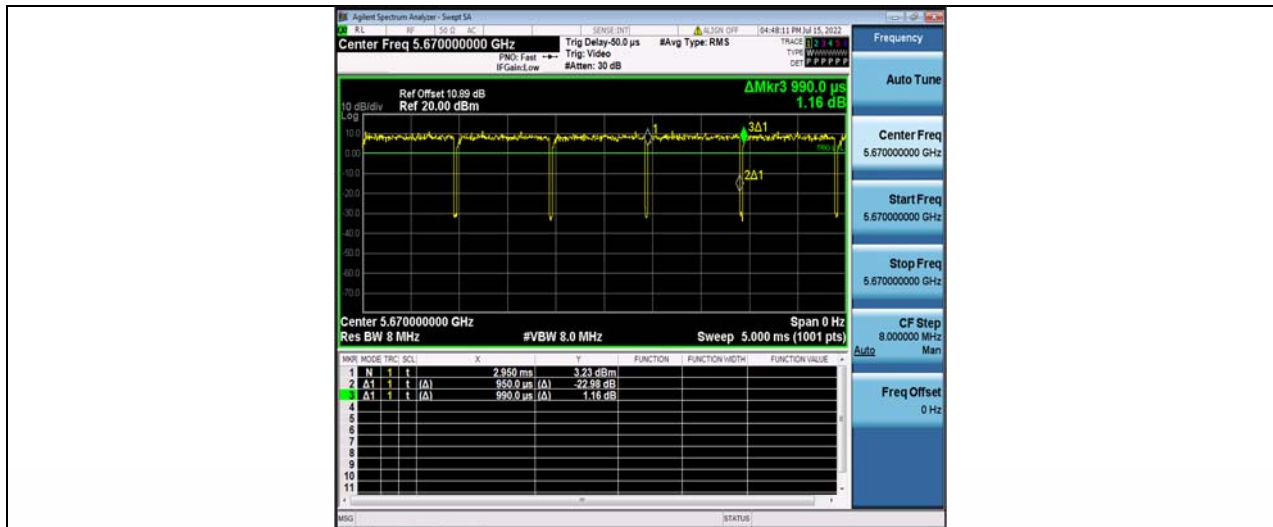

11N40SISO Ant1 5755

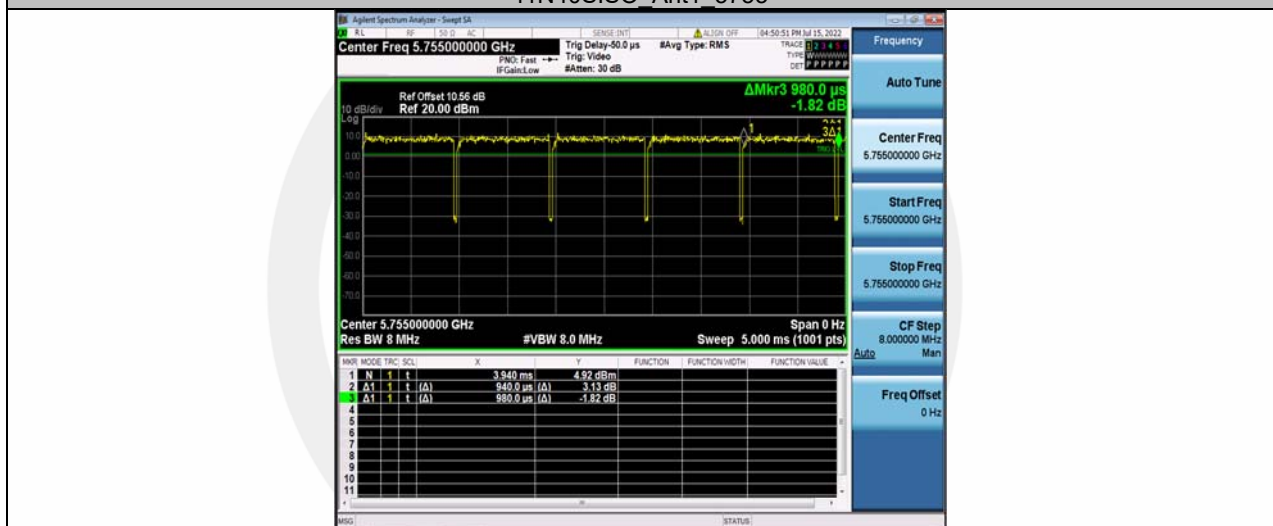

11N40SISO Ant1 5795

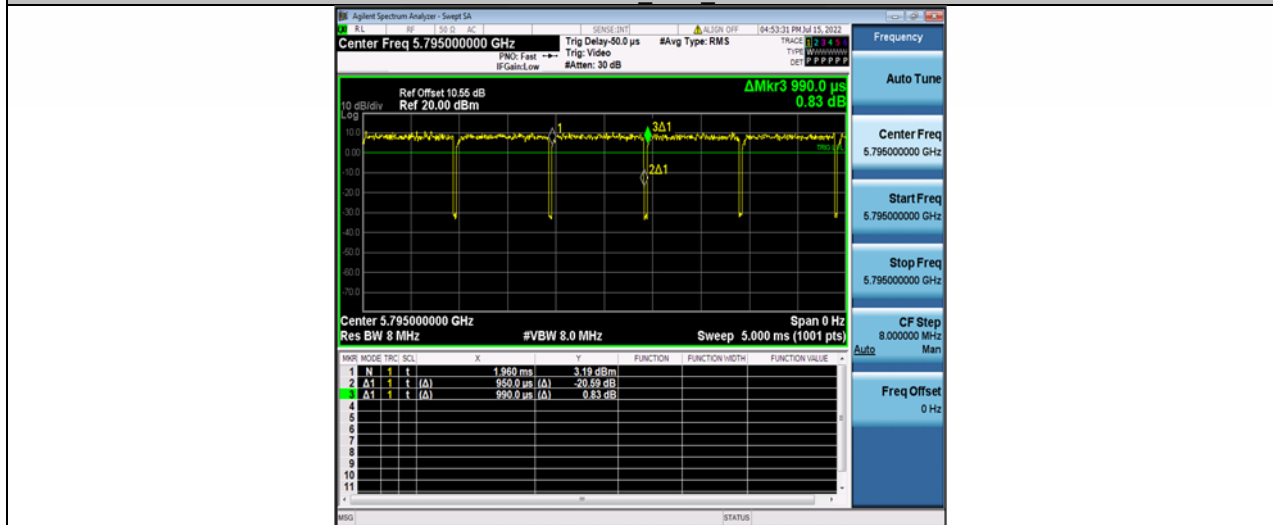

11A20SISO Ant1 5180

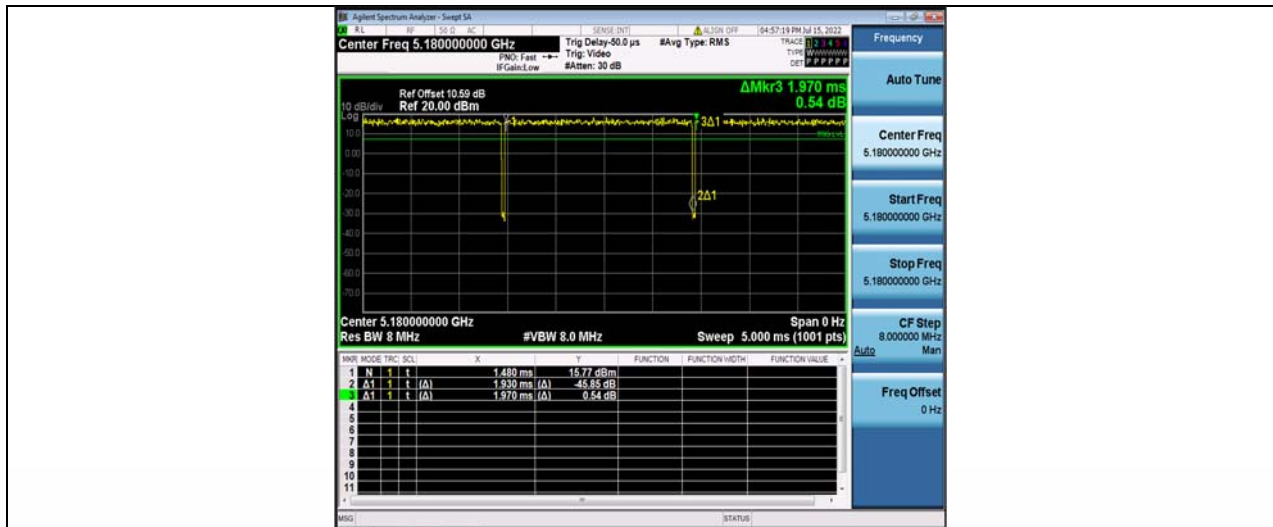

11AC20SISO Ant1 5220

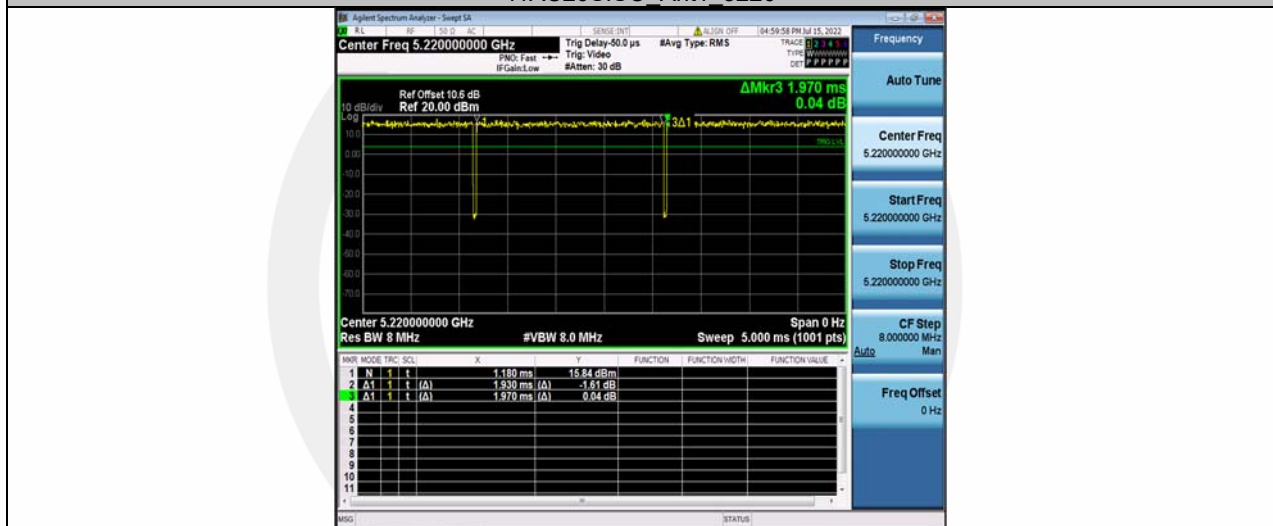

11AC20SISO Ant1 5240

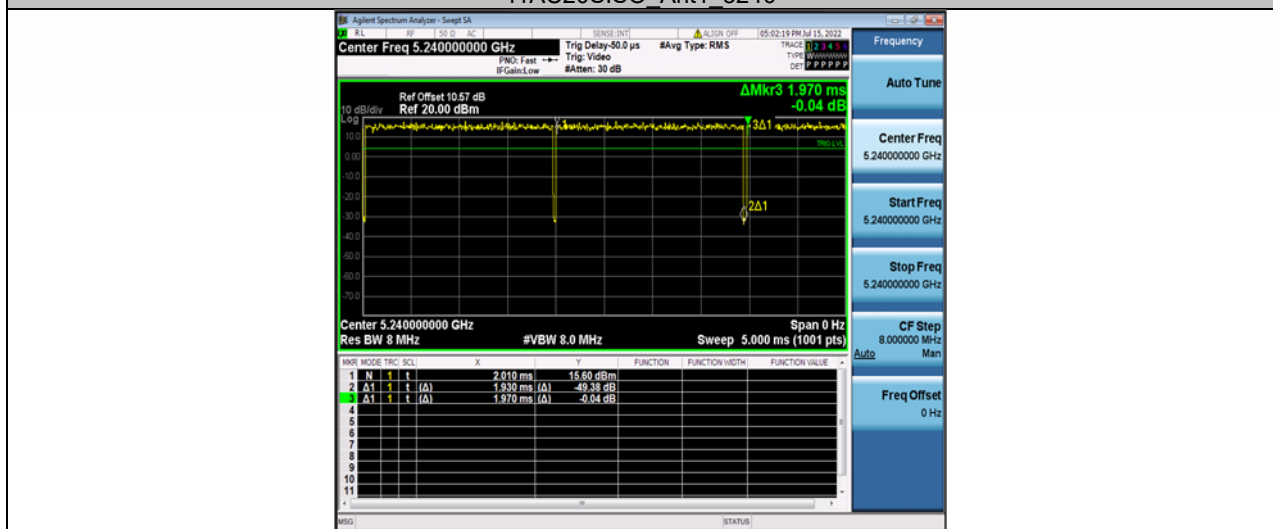

11AC20SISO Ant1 5260



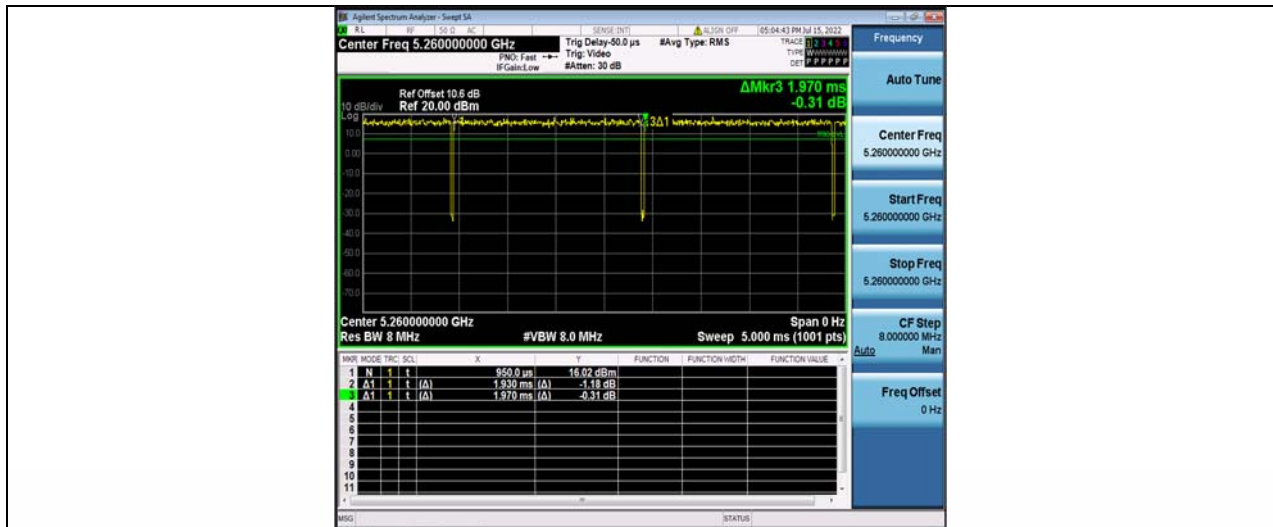

11AC20SISO Ant1 5300

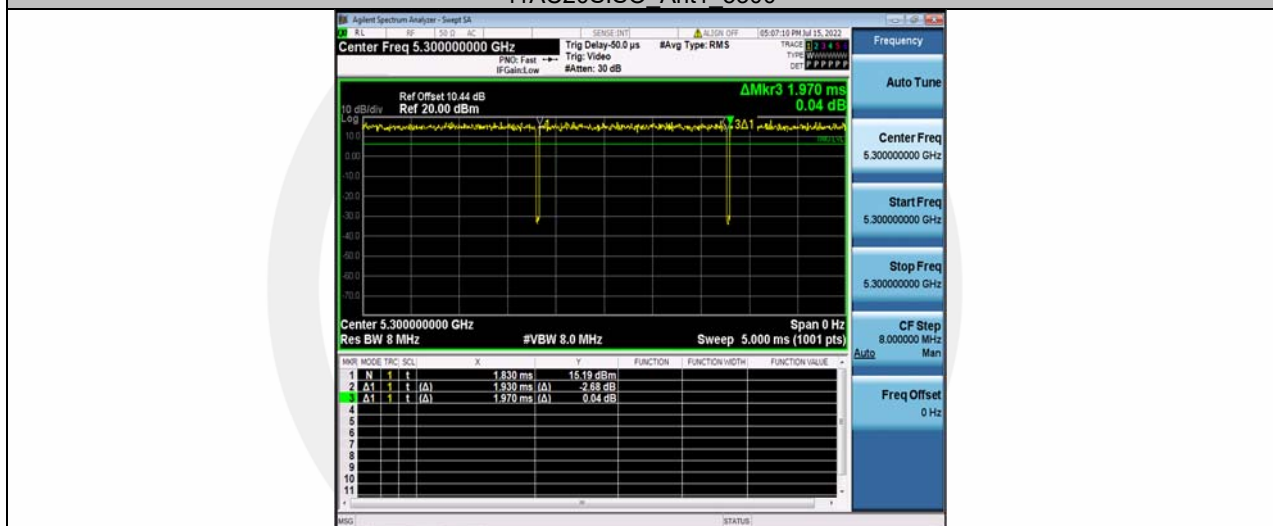

11AC20SISO Ant1 5320

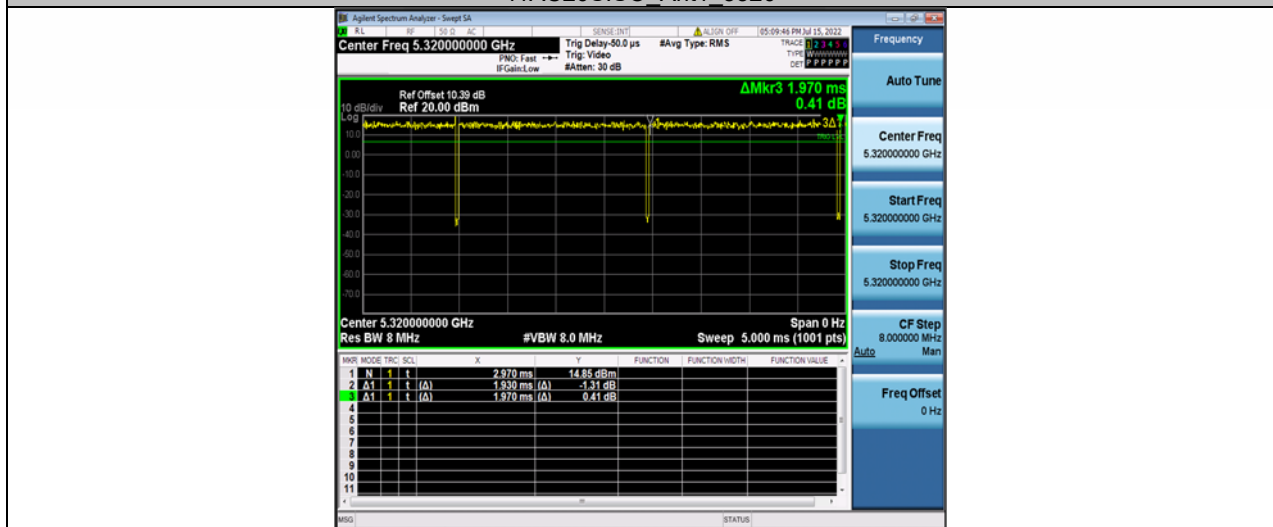

11AC20SISO Ant1 5500

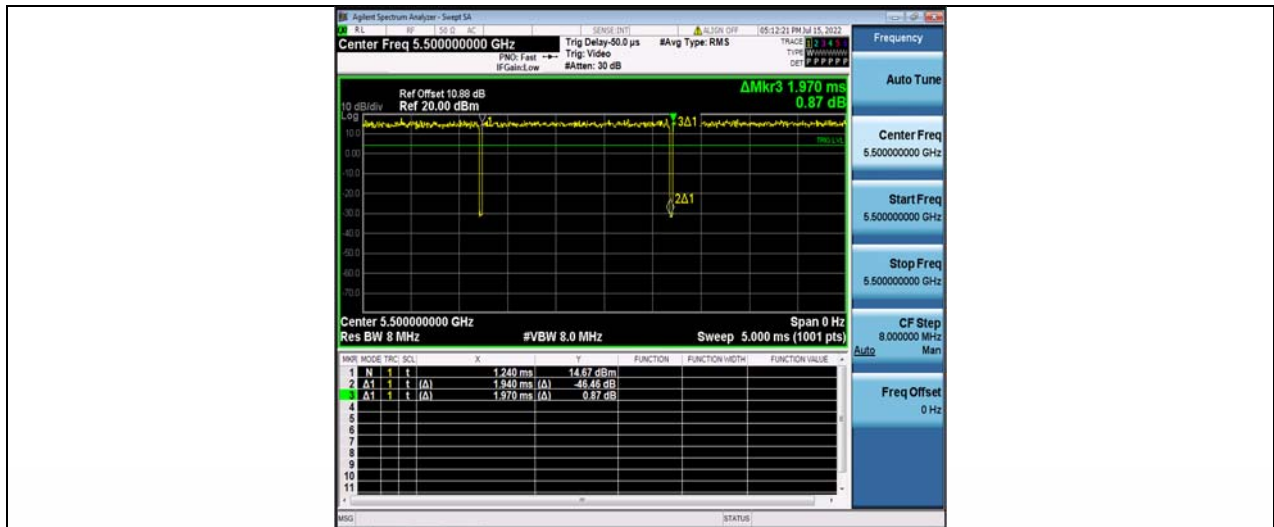

11AC20SISO Ant1 5580

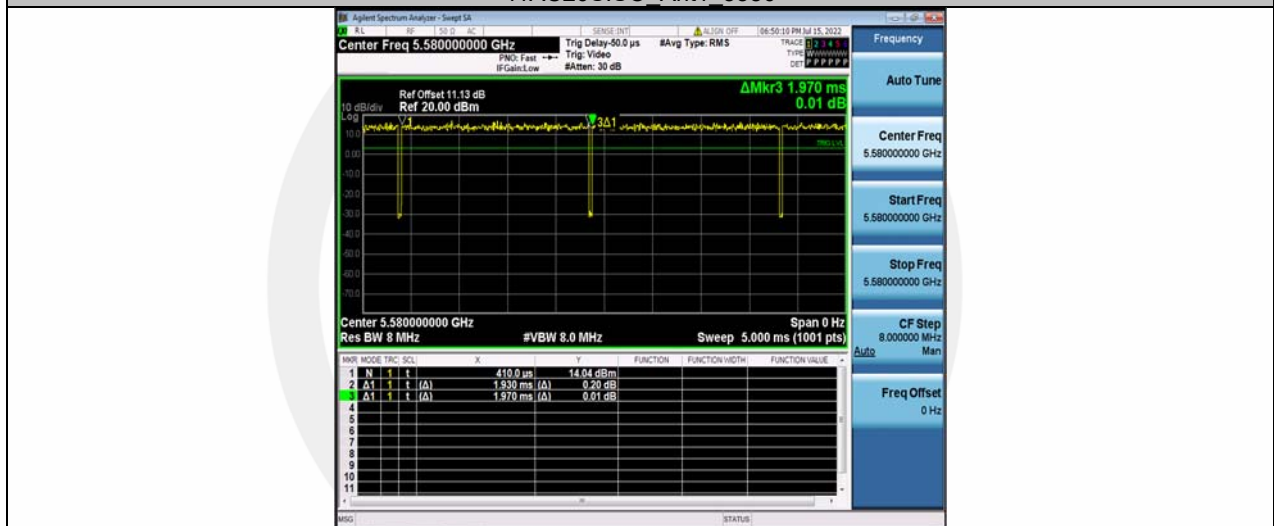

11AC20SISO Ant1 5700

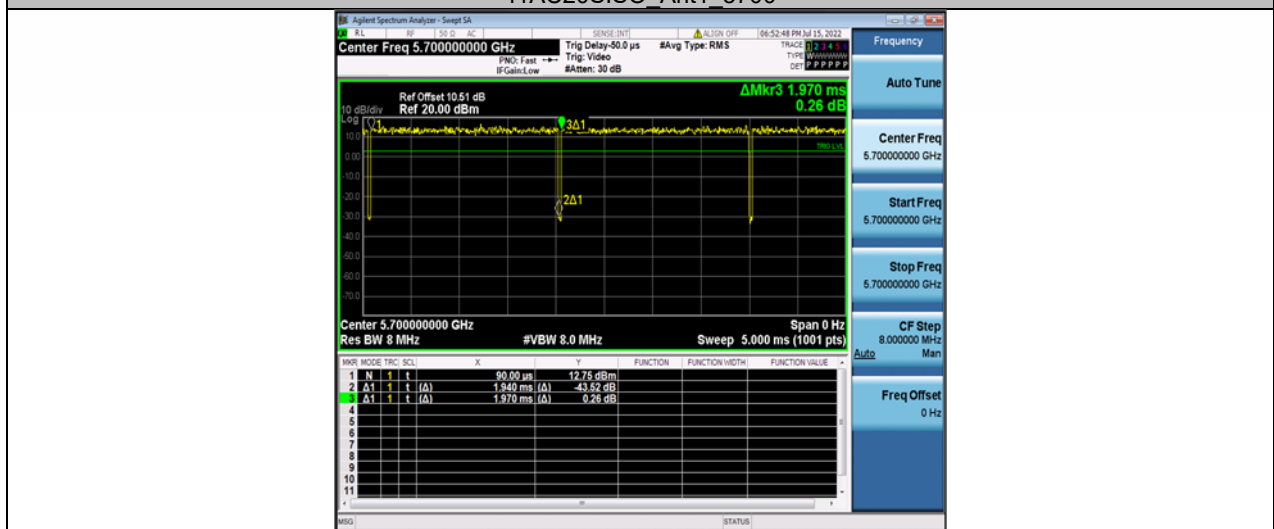

11AC20SISO Ant1 5745

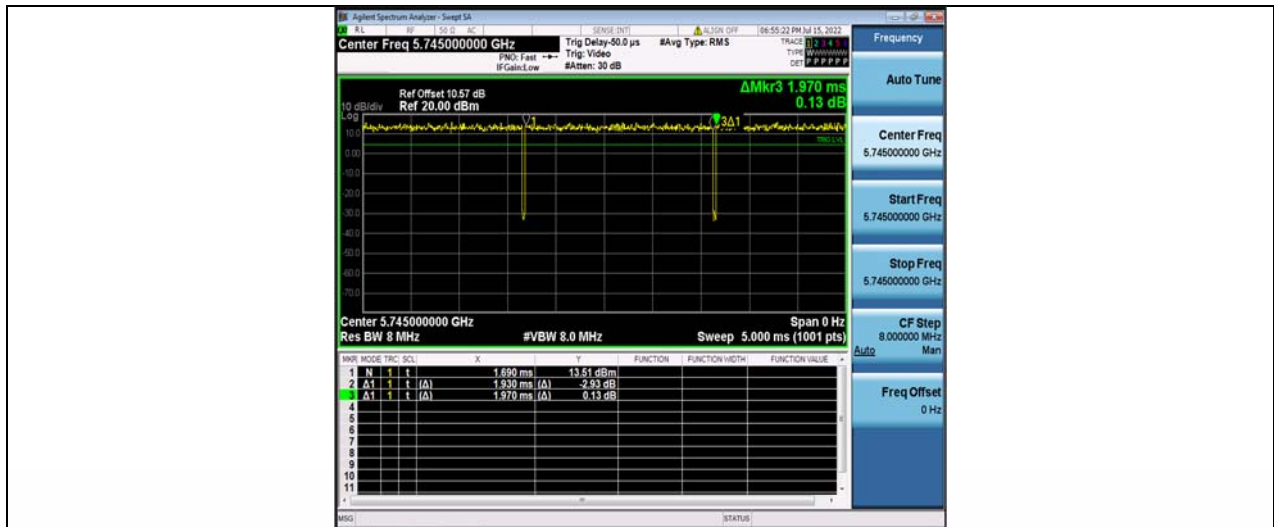

11AC20SISO Ant1 5785

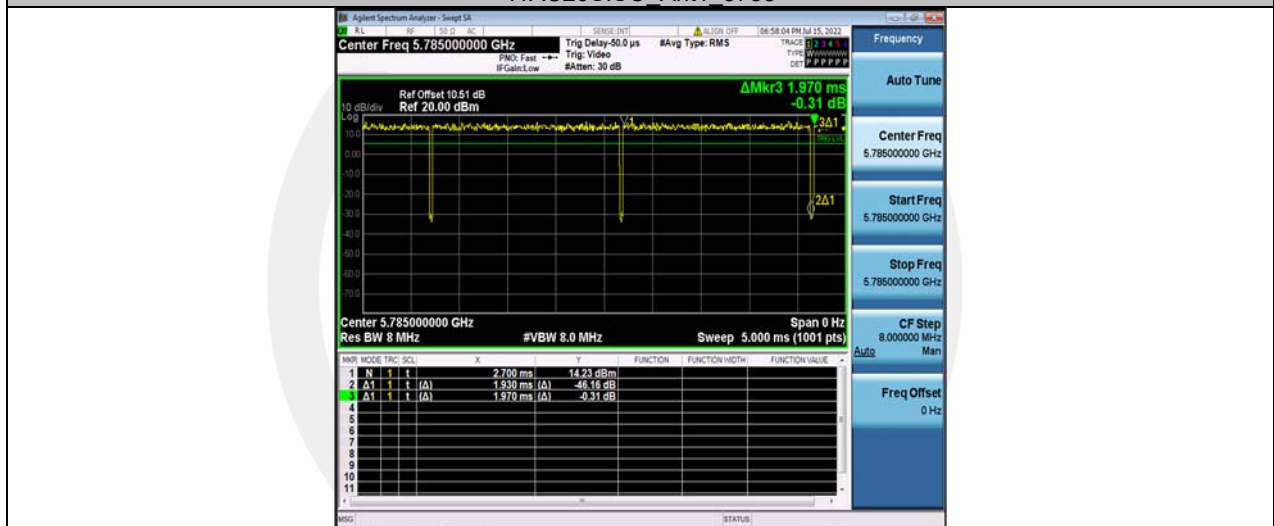

11AC20SISO Ant1 5825

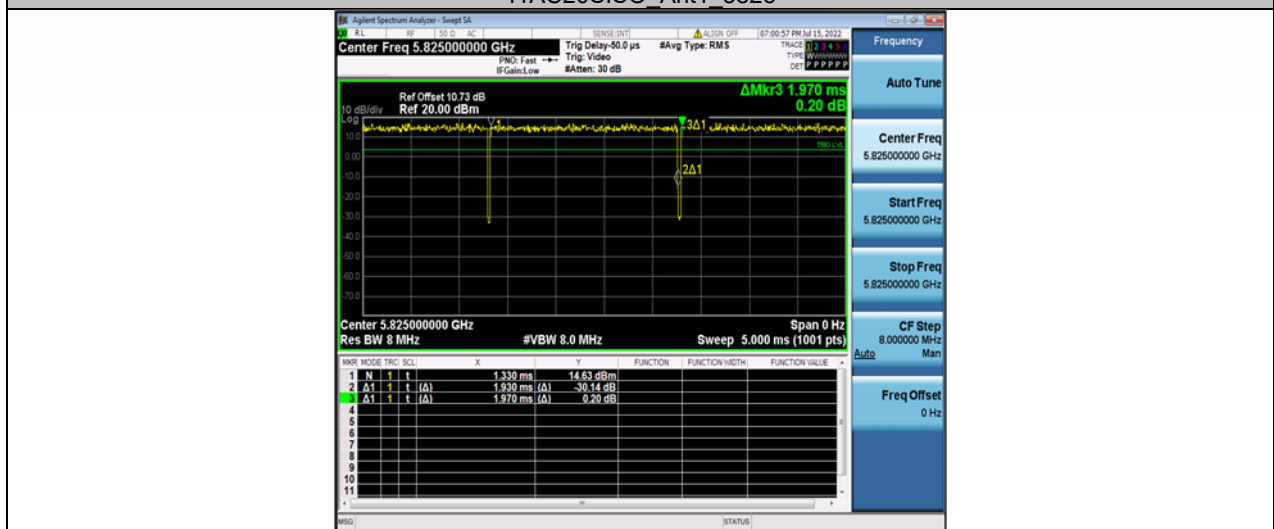

11AC40SISO Ant1 5190

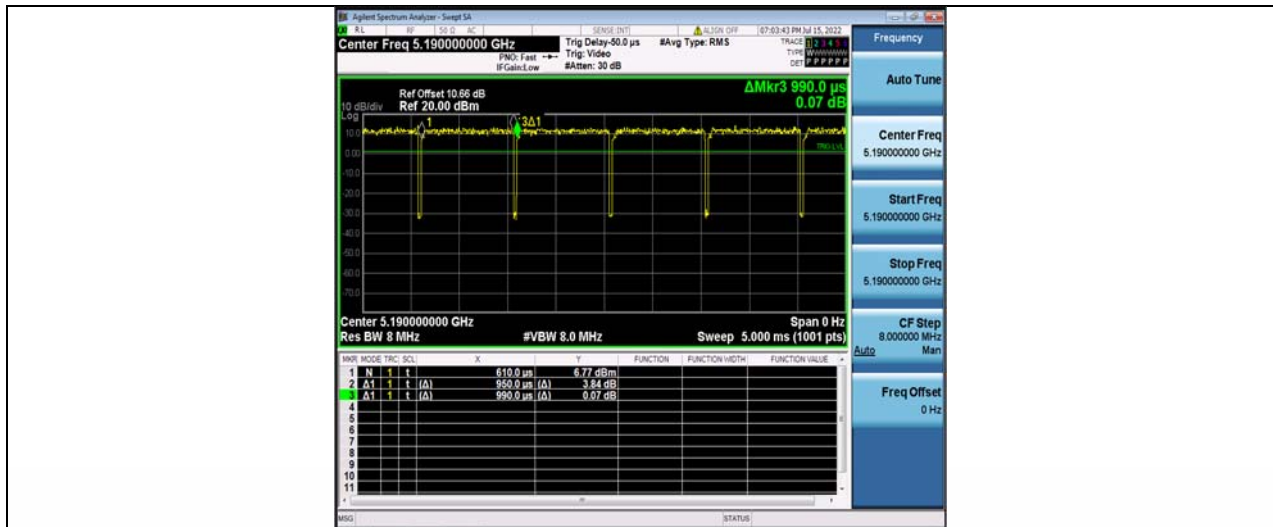

11AC40SISO Ant1 5230

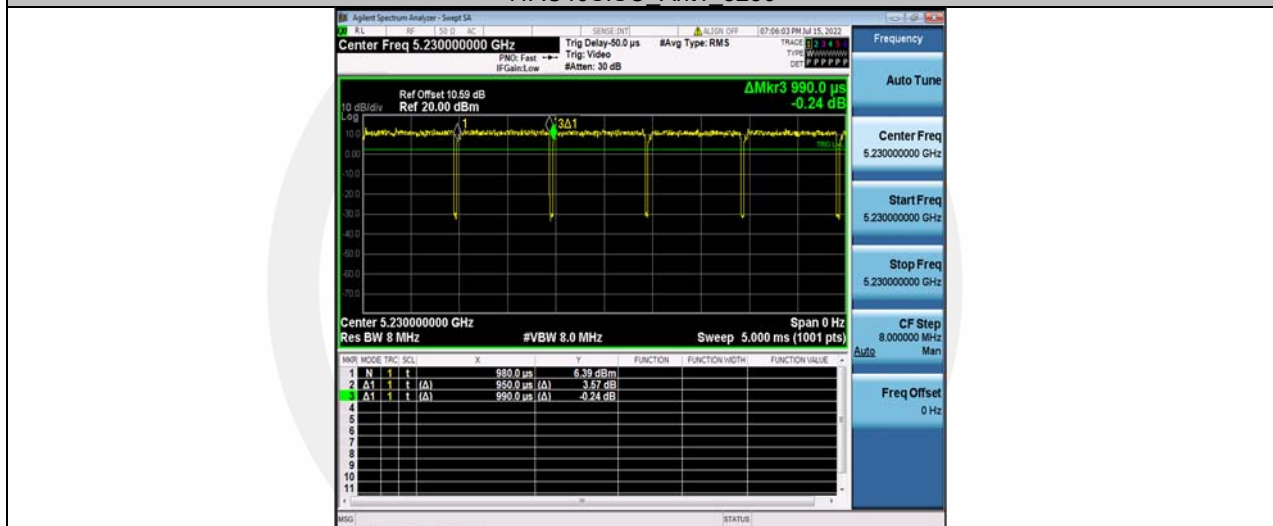

11AC40SISO Ant1 5270

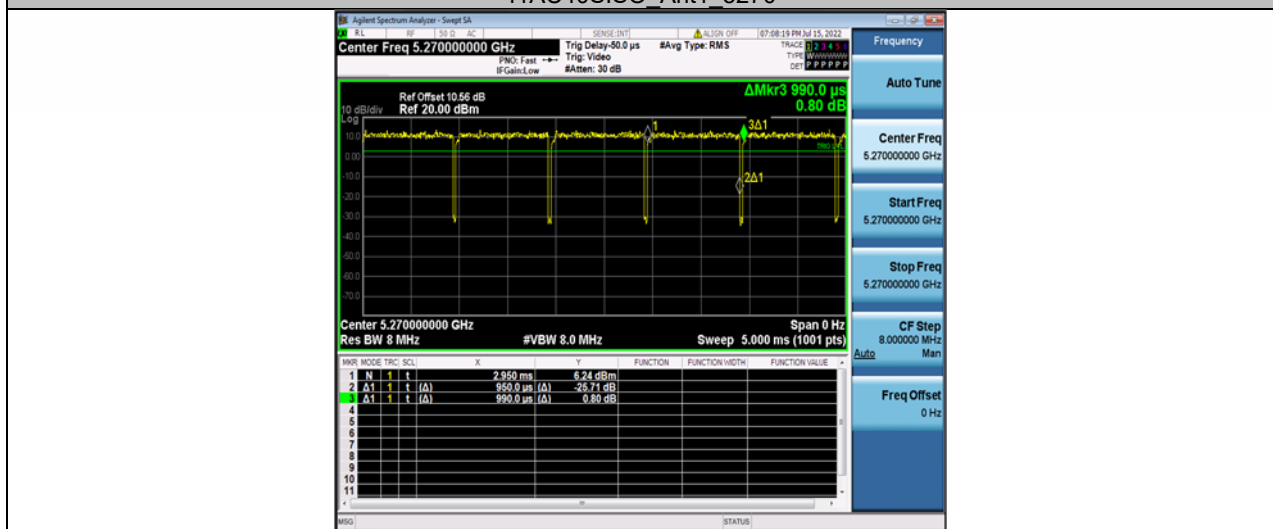

11AC40SISO Ant1 5310



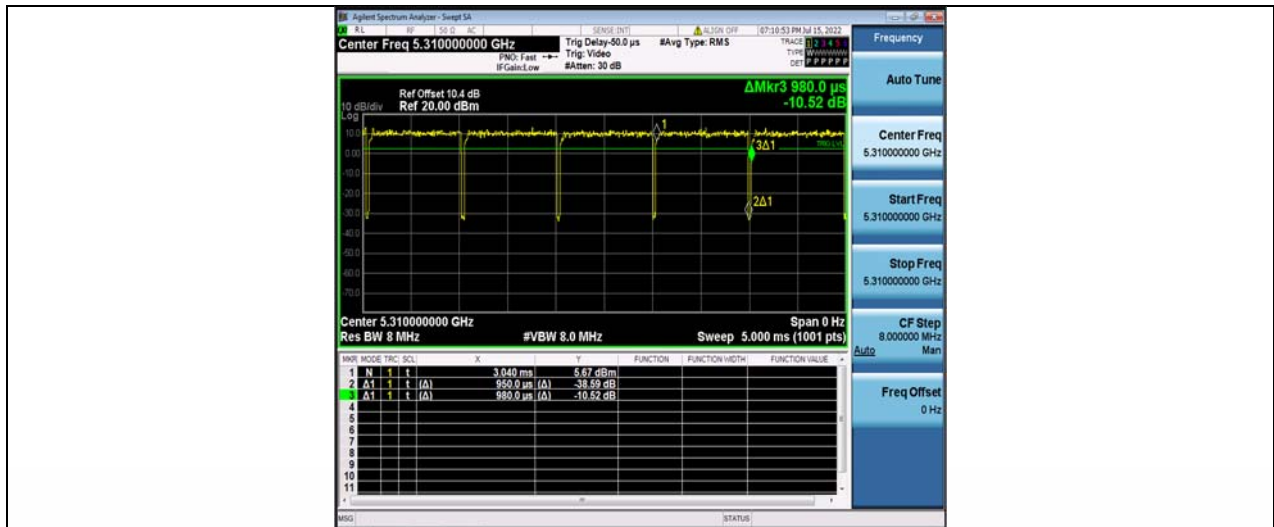

11AC40SISO Ant1 5510

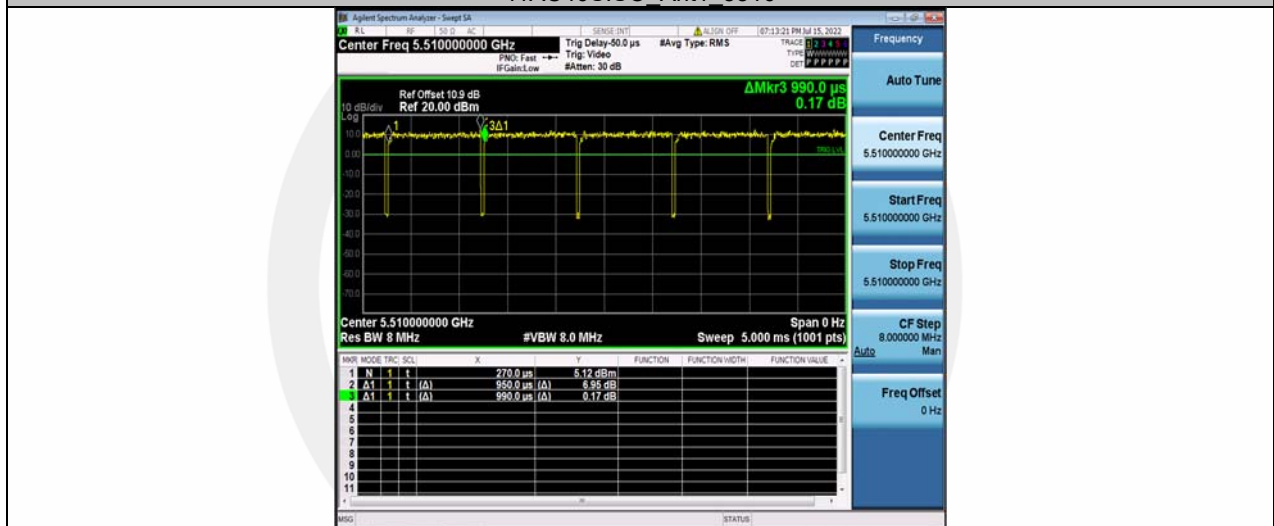

11AC40SISO Ant1 5550

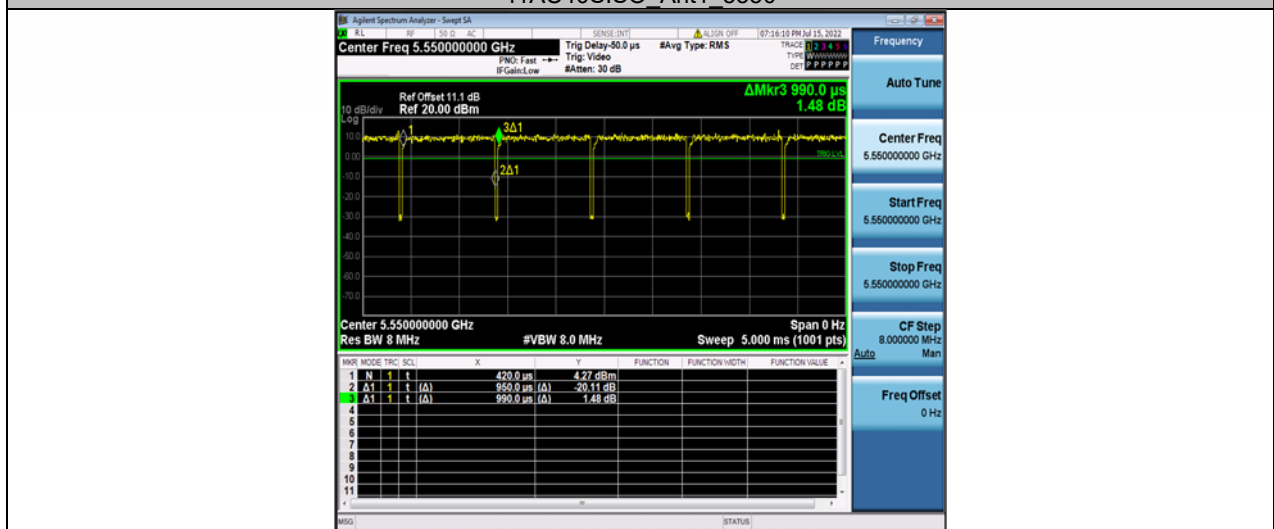

11AC40SISO Ant1 5670

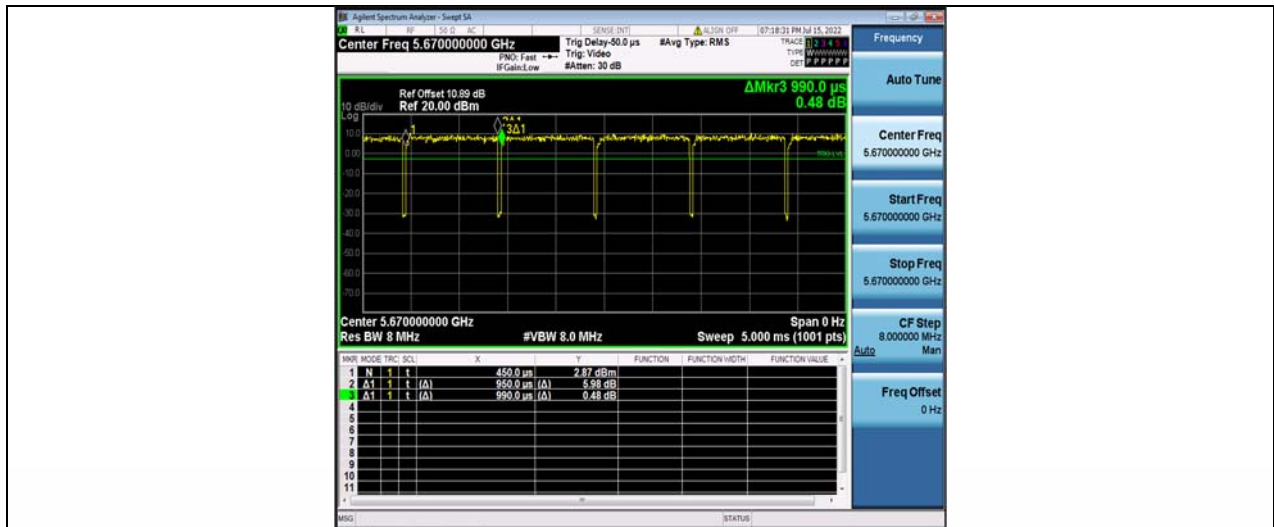

11AC40SISO Ant1 5755

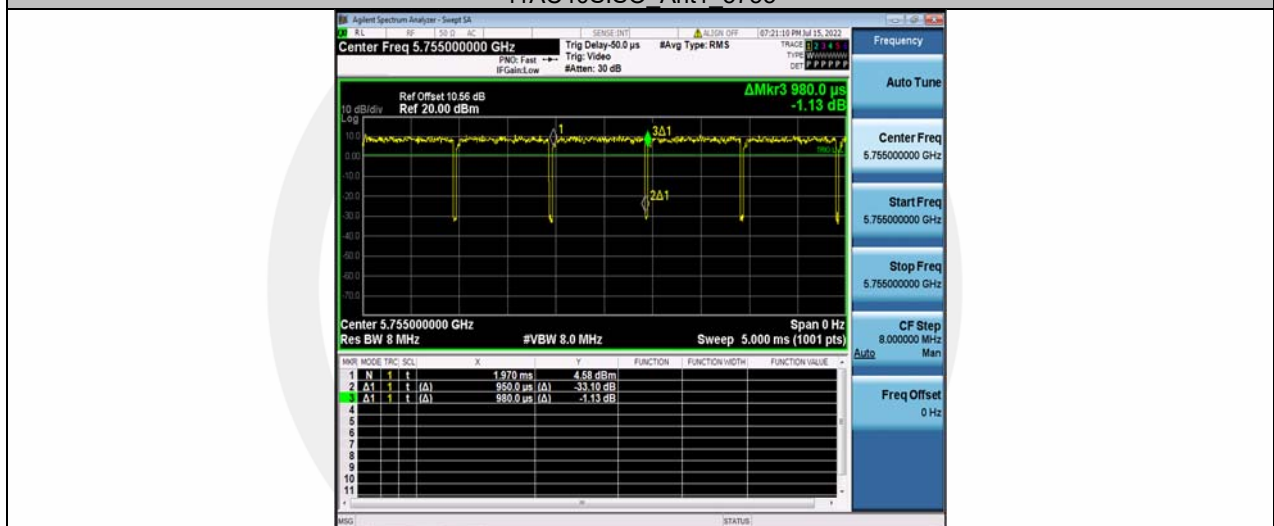

11AC40SISO Ant1 5795

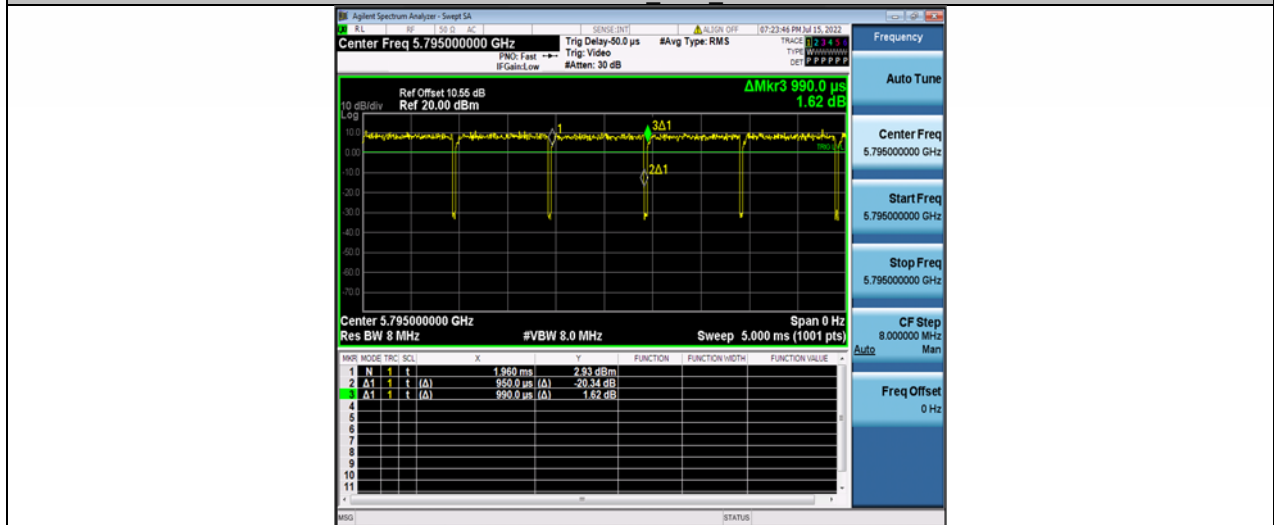

11AC80SISO Ant1 5210

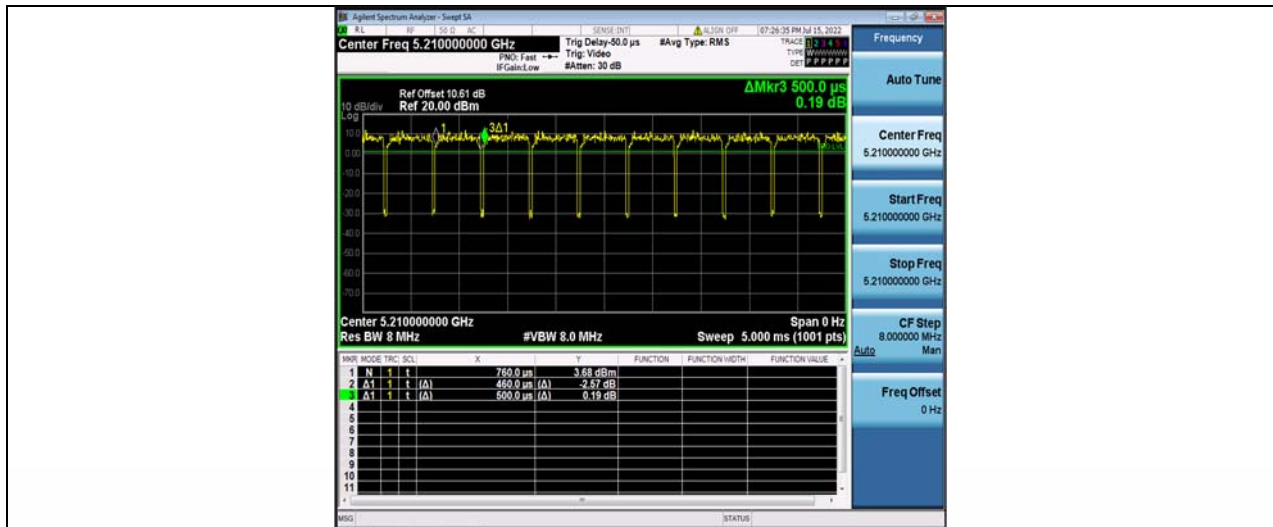

11AC80SISO Ant1 5290

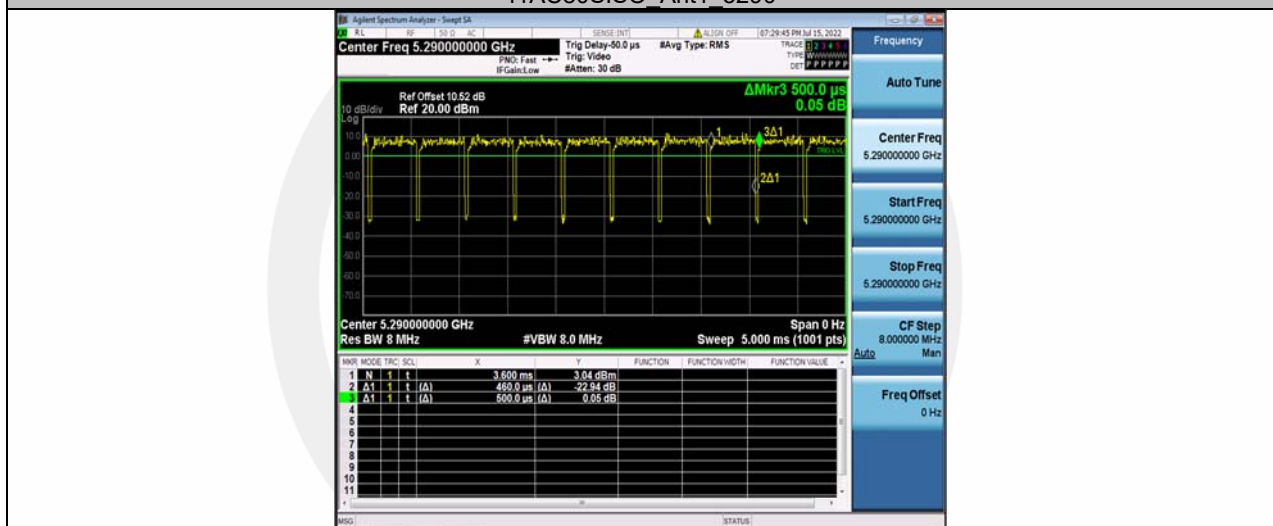

11AC80SISO Ant1 5530

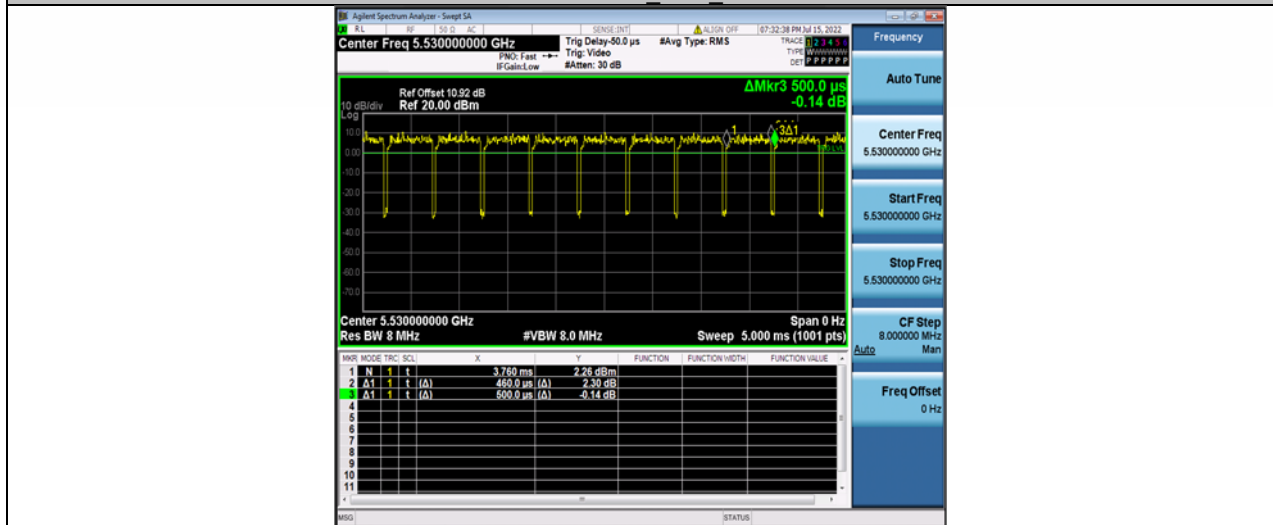

11AC80SISO Ant1 5610

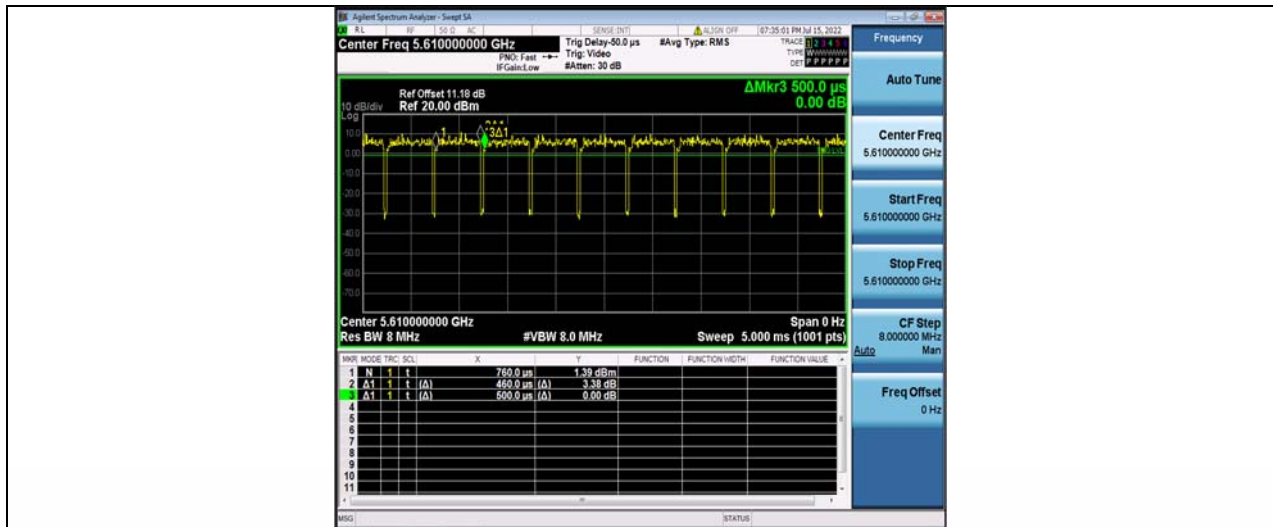

## 11AC80SISO Ant1 5775

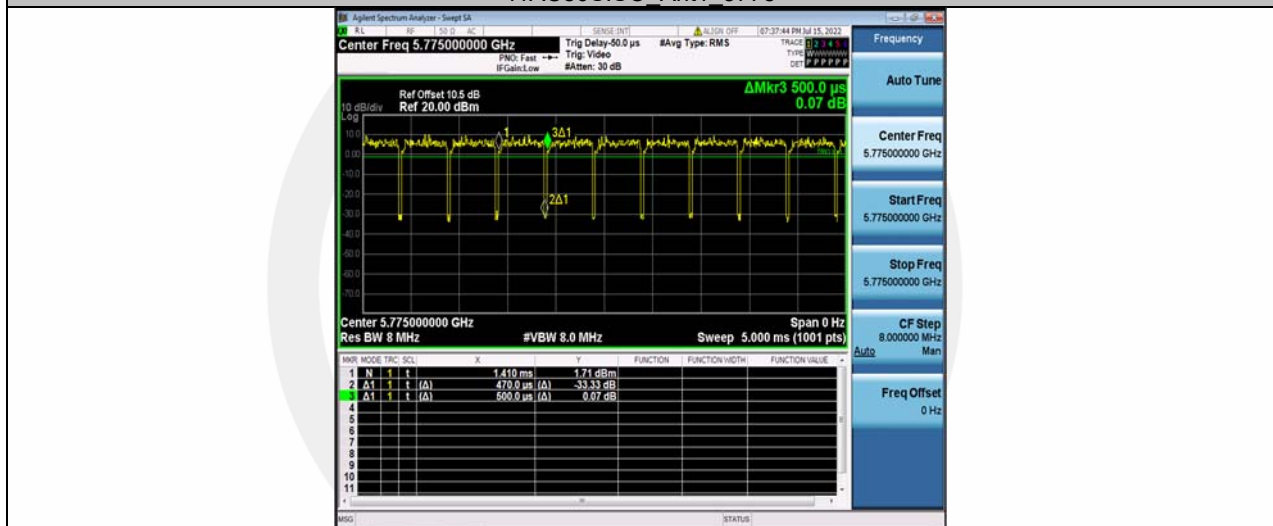



## 8.2 BANDWIDTH MEASUREMENT

### 8.2.1 Applicable Standard

According to FCC Part 15.407(a)  
According to FCC Part 15.407(e)  
According to 789033 D02 Section II(C)  
According to 789033 D02 Section II(D)  
According to RSS-Gen 6.7, RSS 247 6.2

### 8.2.2 Conformance Limit

The 26dB bandwidth is used to determine the conducted power limits.  
Within the 5.725-5.85 GHz band, the minimum 6 dB bandwidth of U-NII devices shall be at least 500 kHz.

### 8.2.3 Test Configuration

Test according to clause 7.1 radio frequency test setup

### 8.2.4 Test Procedure

#### Emission Bandwidth (EBW)

- a) Set RBW = approximately 1% of the emission bandwidth.
- b) Set the VBW > RBW.
- c) Detector = Peak.
- d) Trace mode = max hold.
- e) Measure the maximum width of the emission that is 26 dB down from the maximum of the emission. Compare this with the RBW setting of the analyzer. Readjust RBW and repeat measurement as needed until the RBW/EBW ratio is approximately 1%.

#### Minimum Emission Bandwidth for the band 5.725-5.85 GHz

- a) Set RBW = 100 kHz.
- b) Set the video bandwidth (VBW)  $\geq 3 \times$  RBW.
- c) Detector = Peak.
- d) Trace mode = max hold.
- e) Sweep = auto couple.
- f) Allow the trace to stabilize.
- g) Measure the maximum width of the emission that is constrained by the frequencies associated with the two outermost amplitude points (upper and lower frequencies) that are attenuated by 6 dB relative to the maximum level measured in the fundamental emission.

Note: The automatic bandwidth measurement capability of a spectrum analyzer or EMI receiver may be employed if it implements the functionality described above.

#### 99 Percent Occupied Bandwidth

The following procedure shall be used for measuring (99 %) power bandwidth:

1. Set center frequency to the nominal EUT channel center frequency.
2. Set span = 1.5 times to 5.0 times the OBW.
3. Set RBW = 1 % to 5 % of the OBW
4. Set VBW  $\geq 3 \times$  RBW
5. Video averaging is not permitted. Where practical, a sample detection and single sweep mode shall be used. Otherwise, peak detection and max hold mode (until the trace stabilizes) shall be used.
6. Use the 99 % power bandwidth function of the instrument.

8.2.5 Test Results

Temperature:	25°C
Relative Humidity:	45%
ATM Pressure:	1011 mbar
Test Engineer:	XXH

Note: N/A

**Emission Bandwidth**

TestMode	Antenna	Frequency[MHz]	26db EBW [MHz]	FL[MHz]	FH[MHz]	Limit[MHz]	Verdict
11A	Ant1	5180	29.960	5165.080	5195.040	---	---
		5220	30.080	5204.960	5235.040	---	---
		5240	28.320	5225.600	5253.920	---	---
		5260	28.320	5245.680	5274.000	---	---
		5300	28.200	5285.640	5313.840	---	---
		5320	27.160	5306.640	5333.800	---	---
		5500	24.800	5487.960	5512.760	---	---
		5580	24.320	5568.040	5592.360	---	---
		5700	23.880	5688.360	5712.240	---	---
		5745	23.840	5733.320	5757.160	---	---
		5785	23.360	5773.320	5796.680	---	---
11N20SISO	Ant1	5180	29.200	5165.840	5195.040	---	---
		5220	30.040	5204.920	5234.960	---	---
		5240	29.160	5225.840	5255.000	---	---
		5260	26.880	5246.840	5273.720	---	---
		5300	27.200	5285.960	5313.160	---	---
		5320	25.760	5307.120	5332.880	---	---
		5500	26.040	5486.840	5512.880	---	---
		5580	25.400	5566.840	5592.240	---	---
		5700	24.800	5687.480	5712.280	---	---
		5745	25.000	5732.400	5757.400	---	---
		5785	24.640	5772.200	5796.840	---	---
11N40SISO	Ant1	5190	44.800	5168.560	5213.360	---	---
		5230	42.080	5208.800	5250.880	---	---
		5270	41.760	5248.960	5290.720	---	---
		5310	42.160	5288.880	5331.040	---	---
		5510	41.680	5488.880	5530.560	---	---
		5550	41.600	5529.040	5570.640	---	---
		5670	41.680	5649.360	5691.040	---	---
		5755	40.960	5734.840	5775.800	---	---
		5795	42.160	5773.960	5816.120	---	---
11AC20SISO	Ant1	5180	32.040	5165.080	5197.120	---	---
		5220	30.080	5204.920	5235.000	---	---
		5240	28.760	5226.160	5254.920	---	---
		5260	28.160	5246.240	5274.400	---	---
		5300	28.200	5285.960	5314.160	---	---
		5320	26.800	5307.000	5333.800	---	---
		5500	25.960	5486.920	5512.880	---	---
		5580	25.080	5567.160	5592.240	---	---
5700	24.280	5687.480	5711.760	---	---		

		5745	25.400	5732.480	5757.880	---	---
		5785	24.440	5772.400	5796.840	---	---
		5825	23.360	5813.400	5836.760	---	---
11AC40SISO	Ant1	5190	45.200	5168.320	5213.520	---	---
		5230	44.560	5208.880	5253.440	---	---
		5270	41.680	5248.880	5290.560	---	---
		5310	41.920	5288.880	5330.800	---	---
		5510	41.760	5488.880	5530.640	---	---
		5550	41.520	5529.360	5570.880	---	---
		5670	42.080	5649.040	5691.120	---	---
		5755	41.200	5734.680	5775.880	---	---
		5795	41.440	5774.520	5815.960	---	---
		11AC80SISO	Ant1	5210	112.480	5152.240	5264.720
5290	95.680			5238.480	5334.160	---	---
5530	95.680			5481.520	5577.200	---	---
5610	97.280			5559.440	5656.720	---	---
5775	96.000			5723.640	5819.640	---	---

11A\_Ant1\_5180



11A\_Ant1\_5220



11A\_Ant1\_5240



11A\_Ant1\_5260



11A Ant1 5300



11A Ant1 5320

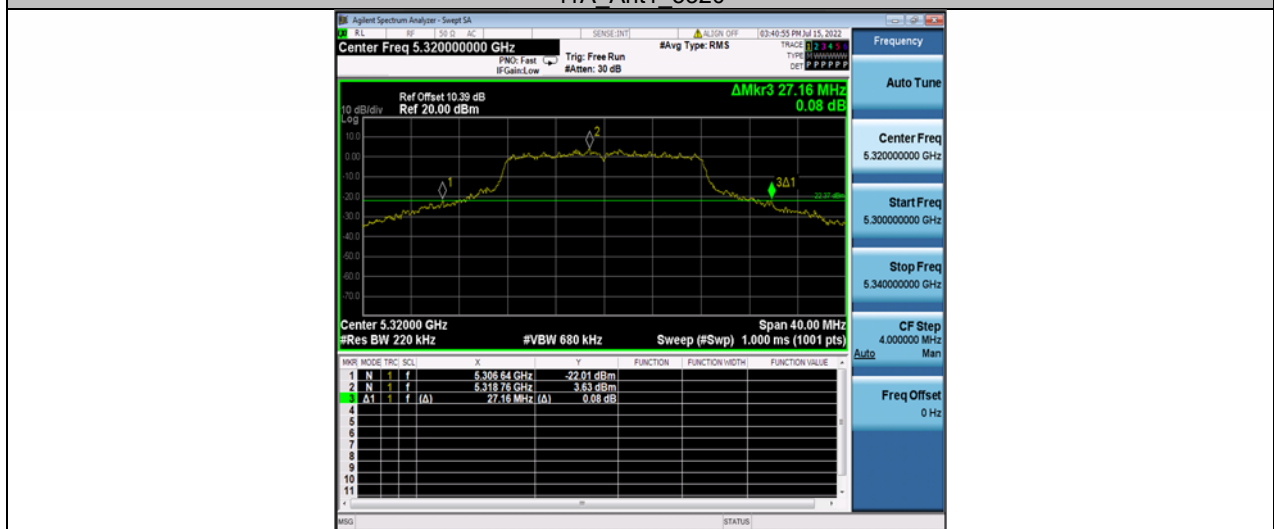

11A Ant1 5500





11A Ant1 5580



11A Ant1 5700

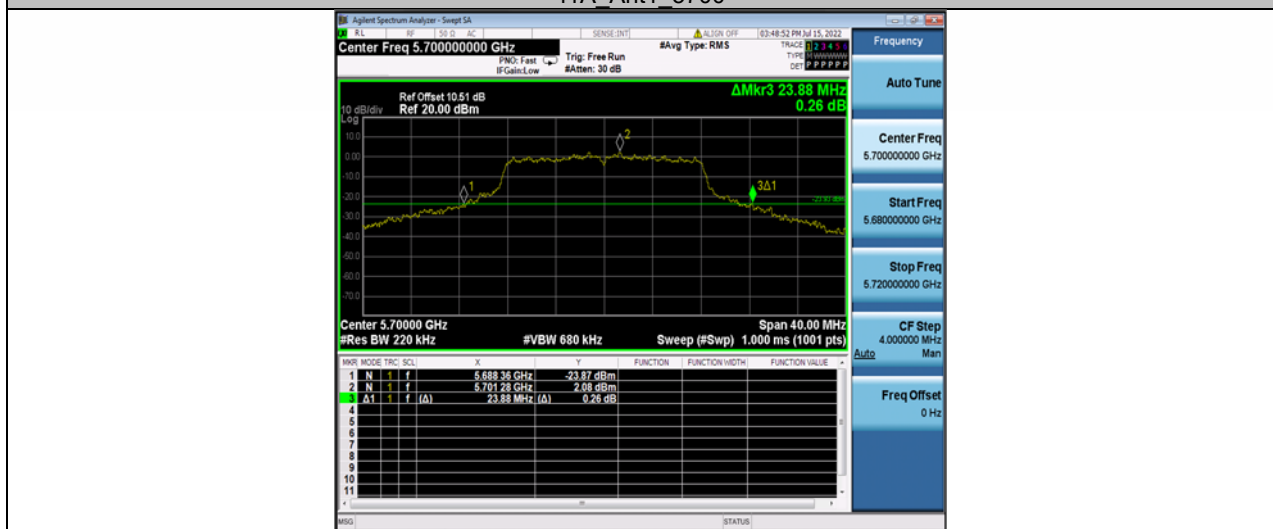

11A Ant1 5745





11A Ant1 5785



11A Ant1 5825

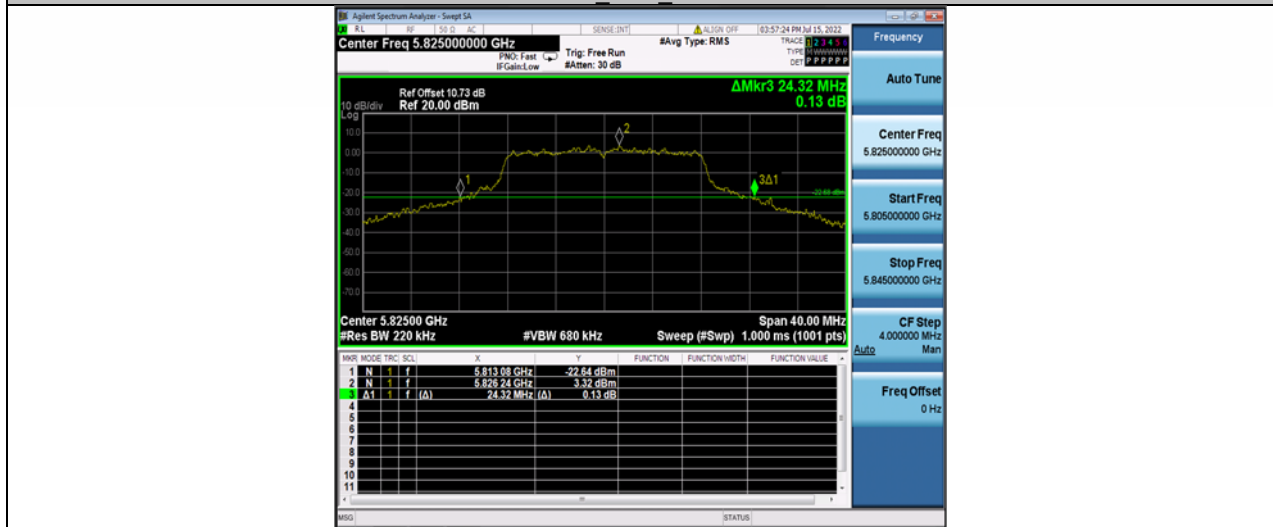

11N20SISO Ant1 5180



11N20SISO Ant1 5220



11N20SISO Ant1 5240

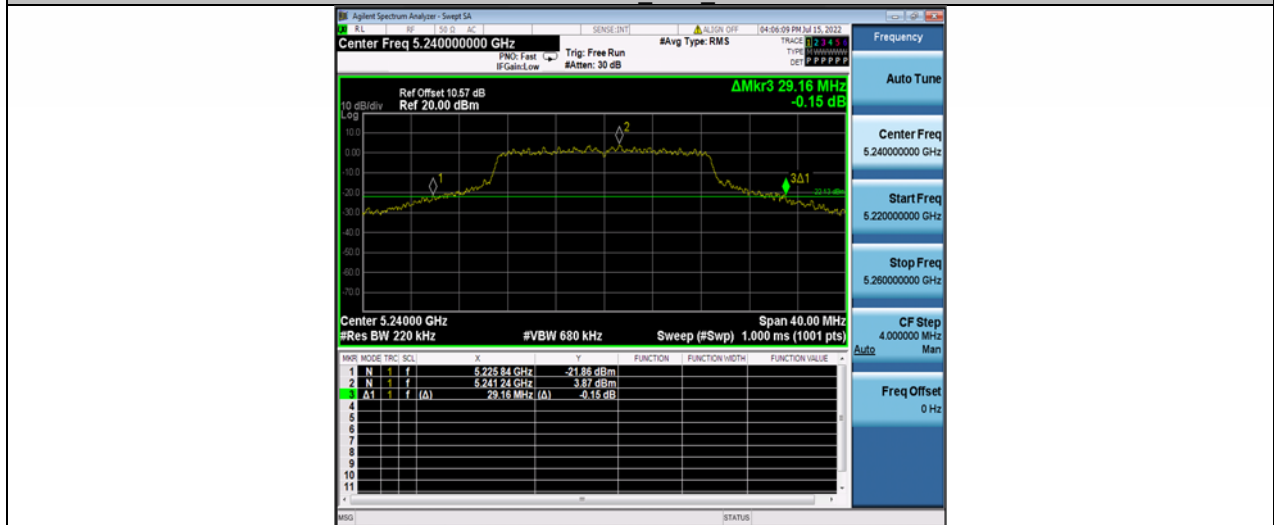

11N20SISO Ant1 5260



11N20SISO Ant1 5300



11N20SISO Ant1 5320

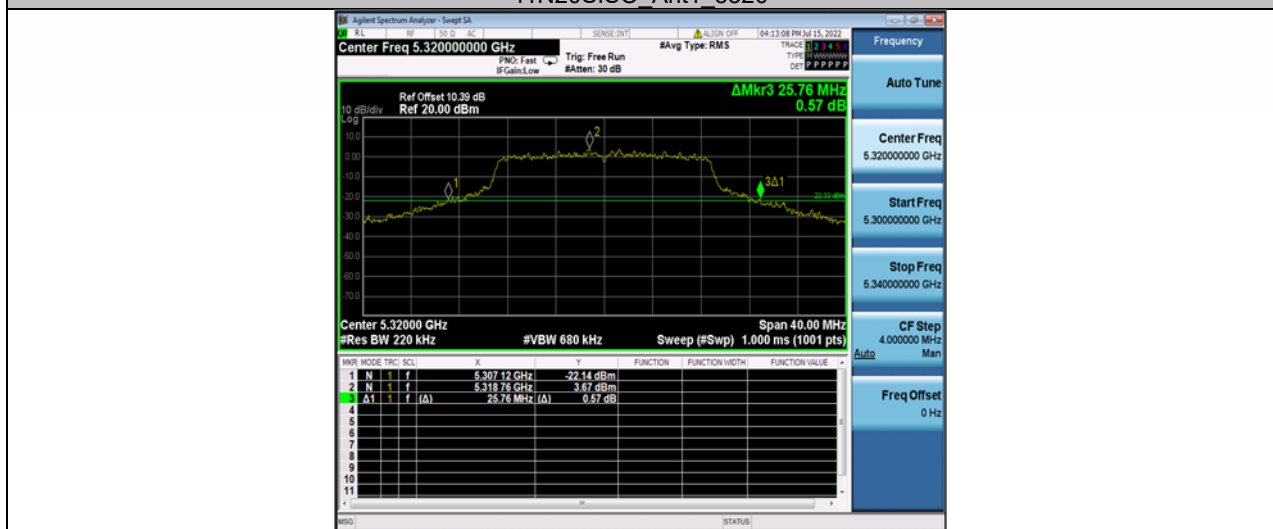

11N20SISO Ant1 5500