



# RF Test Report

For

**Applicant Name:** Xwireless LLC  
**Address:** 11565 Old Georgetown Road, Rockville, MD, USA  
**EUT Name:** Mobile Phone  
**Brand Name:** Vortex  
**Model Number:** HD55 Pro

Issued By

**Company Name:** BTF Testing Lab (Shenzhen) Co., Ltd.  
**Address:** F101, 201 and 301, Building 1, Block 2, Tantou Industrial Park,  
Tantou Community, Songgang Street, Bao'an District, Shenzhen,  
China

**Report Number:** BTF240419R00903  
**Test Standards:** 47 CFR Part 15.247

**Test Conclusion:** Pass  
**FCC ID:** 2ADLJ-HD55PRO  
**Test Date:** 2024-04-20 to 2024-05-08  
**Date of Issue:** 2024-05-09

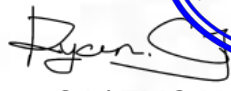
**Prepared By:**   
**Date:** 2024-05-09  
**Approved By:**   
**Date:** 2024-05-09

Chris Liu / Project Engineer  
Ryan.CJ / EMC Manager

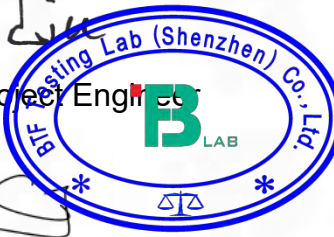

*Note: All the test results in this report only related to the testing samples. Which can be duplicated completely for the legal use with approval of applicant; it shall not be reproduced except in full without the written approval of BTF Testing Lab (Shenzhen) Co., Ltd., All the objections should be raised within thirty days from the date of issue. To validate the report, you can contact us.*



Revision History		
Version	Issue Date	Revisions Content
R_V0	2024-05-09	Original

*Note: Once the revision has been made, then previous versions reports are invalid.*

## Table of Contents

1	<b>INTRODUCTION</b> .....	5
1.1	Identification of Testing Laboratory .....	5
1.2	Identification of the Responsible Testing Location .....	5
1.3	Announcement .....	5
2	<b>PRODUCT INFORMATION</b> .....	6
2.1	Application Information .....	6
2.2	Manufacturer Information.....	6
2.3	Factory Information .....	6
2.4	General Description of Equipment under Test (EUT) .....	6
2.5	Technical Information .....	6
3	<b>SUMMARY OF TEST RESULTS</b> .....	7
3.1	Test Standards.....	7
3.2	Uncertainty of Test .....	7
3.3	Summary of Test Result .....	7
4	<b>TEST CONFIGURATION</b> .....	8
4.1	Test Equipment List .....	8
4.2	Test Auxiliary Equipment .....	10
4.3	Test Modes.....	10
5	<b>EVALUATION RESULTS (EVALUATION)</b> .....	11
5.1	Antenna requirement .....	11
5.1.1	Conclusion:.....	11
6	<b>RADIO SPECTRUM MATTER TEST RESULTS (RF)</b> .....	12
6.1	<b>Conducted Emission at AC power line</b> .....	12
6.1.1	E.U.T. Operation: .....	12
6.1.2	Test Setup Diagram:.....	12
6.1.3	Test Data: .....	13
6.2	<b>Occupied Bandwidth</b> .....	15
6.2.1	E.U.T. Operation: .....	15
6.2.2	Test Setup Diagram:.....	15
6.2.3	Test Data: .....	15
6.3	<b>Maximum Conducted Output Power</b> .....	16
6.3.1	E.U.T. Operation: .....	16
6.3.2	Test Setup Diagram:.....	16
6.3.3	Test Data: .....	16
6.4	<b>Power Spectral Density</b> .....	17
6.4.1	E.U.T. Operation: .....	17
6.4.2	Test Setup Diagram:.....	17
6.4.3	Test Data: .....	17
6.5	<b>Emissions in non-restricted frequency bands</b> .....	18
6.5.1	E.U.T. Operation: .....	18
6.5.2	Test Setup Diagram:.....	18
6.5.3	Test Data: .....	18
6.6	<b>Band edge emissions (Radiated)</b> .....	19
6.6.1	E.U.T. Operation: .....	19
6.6.2	Test Setup Diagram:.....	19
6.6.3	Test Data: .....	20
6.7	<b>Emissions in frequency bands (below 1GHz)</b> .....	21
6.7.1	E.U.T. Operation: .....	21
6.7.2	Test Setup Diagram:.....	21



6.7.3	Test Data: .....	22
<b>6.8</b>	<b>Emissions in frequency bands (above 1GHz) .....</b>	<b>24</b>
6.8.1	E.U.T. Operation: .....	24
6.8.2	Test Setup Diagram: .....	24
6.8.3	Test Data: .....	25
<b>7</b>	<b>TEST SETUP PHOTOS .....</b>	<b>27</b>
<b>8</b>	<b>EUT CONSTRUCTIONAL DETAILS (EUT PHOTOS) .....</b>	<b>29</b>
	<b>APPENDIX.....</b>	<b>30</b>

## 1 Introduction

### 1.1 Identification of Testing Laboratory

Company Name:	BTF Testing Lab (Shenzhen) Co., Ltd.
Address:	F101, 201 and 301, Building 1, Block 2, Tantou Industrial Park, Tantou Community, Songgang Street, Bao'an District, Shenzhen, China
Phone Number:	+86-0755-23146130
Fax Number:	+86-0755-23146130

### 1.2 Identification of the Responsible Testing Location

Company Name:	BTF Testing Lab (Shenzhen) Co., Ltd.
Address:	F101, 201 and 301, Building 1, Block 2, Tantou Industrial Park, Tantou Community, Songgang Street, Bao'an District, Shenzhen, China
Phone Number:	+86-0755-23146130
Fax Number:	+86-0755-23146130
FCC Registration Number:	518915
Designation Number:	CN1330

### 1.3 Announcement

- (1) The test report reference to the report template version v0.
- (2) The test report is invalid if not marked with the signatures of the persons responsible for preparing, reviewing and approving the test report.
- (3) The test report is invalid if there is any evidence and/or falsification.
- (4) This document may not be altered or revised in any way unless done so by BTF and all revisions are duly noted in the revisions section.
- (5) Content of the test report, in part or in full, cannot be used for publicity and/or promotional purposes without prior written approval from the laboratory.
- (6) The laboratory is only responsible for the data released by the laboratory, except for the part provided by the applicant.

## 2 Product Information

### 2.1 Application Information

Company Name:	Xwireless LLC
Address:	11565 Old Georgetown Road, Rockville, MD, USA

### 2.2 Manufacturer Information

Company Name:	Xwireless LLC
Address:	11565 Old Georgetown Road, Rockville, MD, USA

### 2.3 Factory Information

Company Name:	ZTECH COMMUNICATION(SZ) CO LTD
Address:	FL 7 BLOCK D BAO'AN ZHIGU INNOVATION PARK YIN'TIAN ROAD NO.4 XI'XIANG STR' BAO'AN DISTRICT SZ CHINA

### 2.4 General Description of Equipment under Test (EUT)

EUT Name:	Mobile Phone
Test Model Number:	HD55 Pro

### 2.5 Technical Information

Power Supply:	DC 5V from adaptor or DC 3.8V from battery
Power Adaptor:	Input:100-240V 50/60Hz 0.15A Output:5.0V==1.0A
Operation Frequency:	802.11b/g/n(HT20): 2412MHz to 2462MHz; 802.11n(HT40): 2422MHz to 2452MHz
Number of Channels:	802.11b/g/n(HT20): 11 Channels; 802.11n(HT40): 7 Channels
Modulation Type:	802.11b: DSSS(CCK, DQPSK, DBPSK); 802.11g: OFDM(BPSK, QPSK, 16QAM, 64QAM); 802.11n(HT20 and HT40): OFDM (BPSK, QPSK, 16QAM, 64QAM)
Antenna Type:	FPC
Antenna Gain <sup>#</sup> :	1.11dBi
Note:	<sup>#</sup> : The antenna gain provided by the applicant, and the laboratory will not be responsible for the accumulated calculation results which covers the information provided by the applicant.
Bluetooth Version:	5.0

### 3 Summary of Test Results

#### 3.1 Test Standards

The tests were performed according to following standards:  
**47 CFR Part 15.247:** Operation within the bands 902-928 MHz, 2400-2483.5 MHz, and 5725-5850 MHz

#### 3.2 Uncertainty of Test

Item	Measurement Uncertainty
Conducted Emission (150 kHz-30 MHz)	±2.64dB
Occupied Bandwidth	±69kHz
Transmitter Power, Conducted	±0.87dB
Power Spectral Density	±0.69dB
Conducted Spurious Emissions	±0.95dB
Radiated Spurious Emissions (above 1GHz)	1-6GHz: ±3.94dB 6-18GHz: ±4.16dB
Radiated Spurious Emissions (30M - 1GHz)	±4.12dB

The following measurement uncertainty levels have been estimated for tests performed on the EUT as specified in CISPR 16-4-2. This uncertainty represents an expanded uncertainty expressed at approximately the 95% confidence level using a coverage factor of k=2.

#### 3.3 Summary of Test Result

Item	Standard	Requirement	Result
Antenna requirement	47 CFR Part 15.247	47 CFR 15.203	Pass
Conducted Emission at AC power line	47 CFR Part 15.247	47 CFR 15.207(a)	Pass
Occupied Bandwidth	47 CFR Part 15.247	47 CFR 15.247(a)(2)	Pass
Maximum Conducted Output Power	47 CFR Part 15.247	47 CFR 15.247(b)(3)	Pass
Power Spectral Density	47 CFR Part 15.247	47 CFR 15.247(e)	Pass
Emissions in non-restricted frequency bands	47 CFR Part 15.247	47 CFR 15.247(d), 15.209, 15.205	Pass
Band edge emissions (Radiated)	47 CFR Part 15.247	47 CFR 15.247(d), 15.209, 15.205	Pass
Emissions in frequency bands (below 1GHz)	47 CFR Part 15.247	47 CFR 15.247(d), 15.209, 15.205	Pass
Emissions in frequency bands (above 1GHz)	47 CFR Part 15.247	47 CFR 15.247(d), 15.209, 15.205	Pass

## 4 Test Configuration

### 4.1 Test Equipment List

Conducted Emission at AC power line					
Equipment	Manufacturer	Model No	Inventory No	Cal Date	Cal Due Date
Pulse Limiter	SCHWARZBECK	VTSD 9561-F	00953	/	/
Coaxial Switcher	SCHWARZBECK	CX210	CX210	/	/
V-LISN	SCHWARZBECK	NSLK 8127	01073	2023-11-16	2024-11-15
LISN	AFJ	LS16/110VAC	16010020076	2023-11-16	2024-11-15
EMI Receiver	ROHDE&SCHWARZ	ESCI3	101422	2023-11-15	2024-11-14

Occupied Bandwidth Maximum Conducted Output Power Power Spectral Density Emissions in non-restricted frequency bands					
Equipment	Manufacturer	Model No	Inventory No	Cal Date	Cal Due Date
RFTest software	/	V1.00	/	/	/
RF Control Unit	Techy	TR1029-1	/	/	/
RF Sensor Unit	Techy	TR1029-2	/	/	/
Programmable constant temperature and humidity box	ZZCKONG	ZZ-K02A	20210928007	2023-11-16	2024-11-15
Adjustable Direct Current Regulated Power Supply	Dongguan Tongmen Electronic Technology Co., LTD	etm-6050c	20211026123	/	/
WIDEBAND RADIO COMMUNICATION TESTER	Rohde & Schwarz	CMW500	161997	2023-11-16	2024-11-15
MXA Signal Analyzer	KEYSIGHT	N9020A	MY50410020	2023-11-16	2024-11-15



Band edge emissions (Radiated) Emissions in frequency bands (below 1GHz) Emissions in frequency bands (above 1GHz)					
Equipment	Manufacturer	Model No	Inventory No	Cal Date	Cal Due Date
Coaxial cable Multiflex 141	Schwarzbeck	N/SMA 0.5m	517386	/	/
Preamplifier	SCHWARZBECK	BBV9744	00246	/	/
RE Cable	REBES Talent	UF1-SMASMAM-10m	21101566	/	/
RE Cable	REBES Talent	UF2-NMNM-10m	21101570	/	/
RE Cable	REBES Talent	UF1-SMASMAM-1m	21101568	/	/
RE Cable	REBES Talent	UF2-NMNM-1m	21101576	/	/
RE Cable	REBES Talent	UF2-NMNM-2.5m	21101573	/	/
POSITIONAL CONTROLLER	SKET	PCI-GPIB	/	/	/
Horn Antenna	SCHWARZBECK	BBHA9170	01157	2023-11-13	2024-11-12
EMI TEST RECEIVER	ROHDE&SCHWARZ	ESCI7	101032	2023-11-16	2024-11-15
SIGNAL ANALYZER	ROHDE&SCHWARZ	FSQ40	100010	2023-11-16	2024-11-15
POSITIONAL CONTROLLER	SKET	PCI-GPIB	/	/	/
Broadband Preamplifier	SCHWARZBECK	BBV9718D	00008	2023-11-16	2024-11-15
Horn Antenna	SCHWARZBECK	BBHA9120D	2597	2022-05-22	2024-05-21
EZ EMC	Frad	FA-03A2 RE+	/	/	/
POSITIONAL CONTROLLER	SKET	PCI-GPIB	/	/	/
Log periodic antenna	SCHWARZBECK	VULB 9168	01328	2023-11-13	2024-11-12

## 4.2 Test Auxiliary Equipment

The EUT was tested as an independent device.

## 4.3 Test Modes

No.	Test Modes	Description
TM1	802.11b mode	Keep the EUT in 802.11b transmitting mode.
TM2	802.11g mode	Keep the EUT in 802.11g transmitting mode.
TM3	802.11n(HT20) mode	Keep the EUT in 802.11n(HT20) transmitting mode.
TM4	802.11n(HT40) mode	Keep the EUT in 802.11n(HT40) transmitting mode.

## 5 Evaluation Results (Evaluation)

### 5.1 Antenna requirement

Test Requirement:	Refer to 47 CFR Part 15.203, an intentional radiator shall be designed to ensure that no antenna other than that furnished by the responsible party shall be used with the device. The use of a permanently attached antenna or of an antenna that uses a unique coupling to the intentional radiator shall be considered sufficient to comply with the provisions of this section.
-------------------	---

#### 5.1.1 Conclusion:



## 6 Radio Spectrum Matter Test Results (RF)

### 6.1 Conducted Emission at AC power line

Test Requirement:	Refer to 47 CFR 15.207(a), Except as shown in paragraphs (b) and (c) of this section, for an intentional radiator that is designed to be connected to the public utility (AC) power line, the radio frequency voltage that is conducted back onto the AC power line on any frequency or frequencies, within the band 150 kHz to 30 MHz, shall not exceed the limits in the following table, as measured using a 50 $\mu$ H/50 ohms line impedance stabilization network (LISN).		
Test Method:	ANSI C63.10-2013 section 6.2		
Test Limit:	Frequency of emission (MHz)	Conducted limit (dB $\mu$ V)	
		Quasi-peak	Average
	0.15-0.5	66 to 56*	56 to 46*
	0.5-5	56	46
	5-30	60	50
Procedure:	*Decreases with the logarithm of the frequency. Refer to ANSI C63.10-2013 section 6.2, standard test method for ac power-line conducted emissions from unlicensed wireless devices		

#### 6.1.1 E.U.T. Operation:

Operating Environment:	
Temperature:	25.7 °C
Humidity:	48.1 %
Atmospheric Pressure:	1010 mbar

#### 6.1.2 Test Setup Diagram:

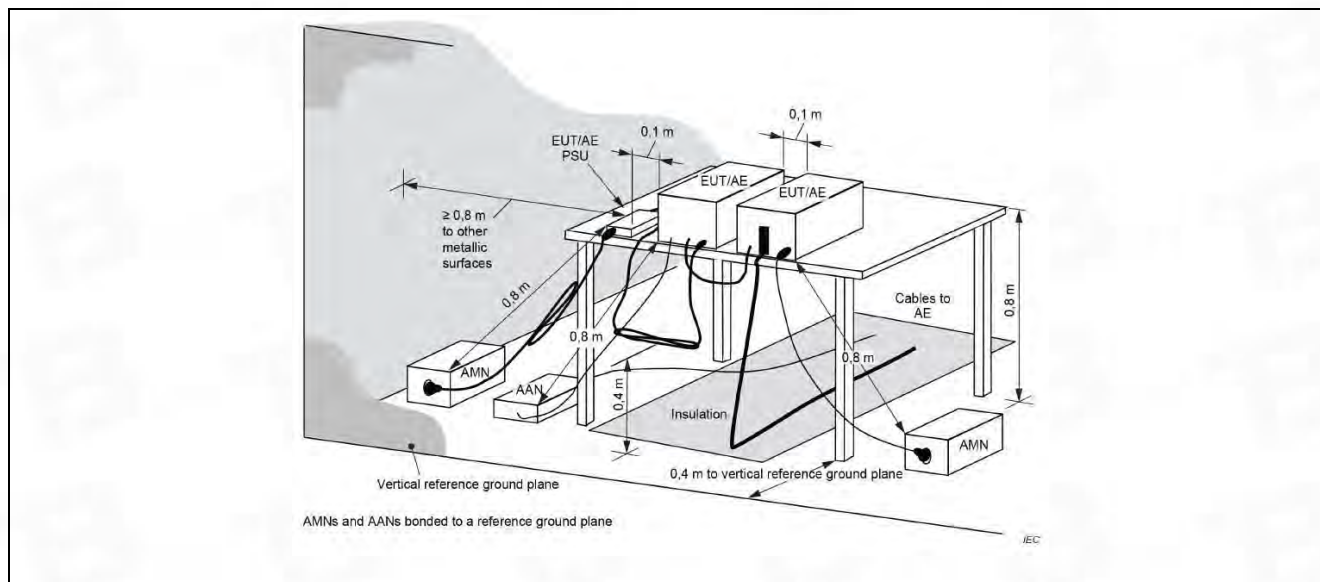

6.1.3 Test Data:

TM1 / Line: Line / Band: 2400-2483.5 MHz / BW: 20 / CH: M

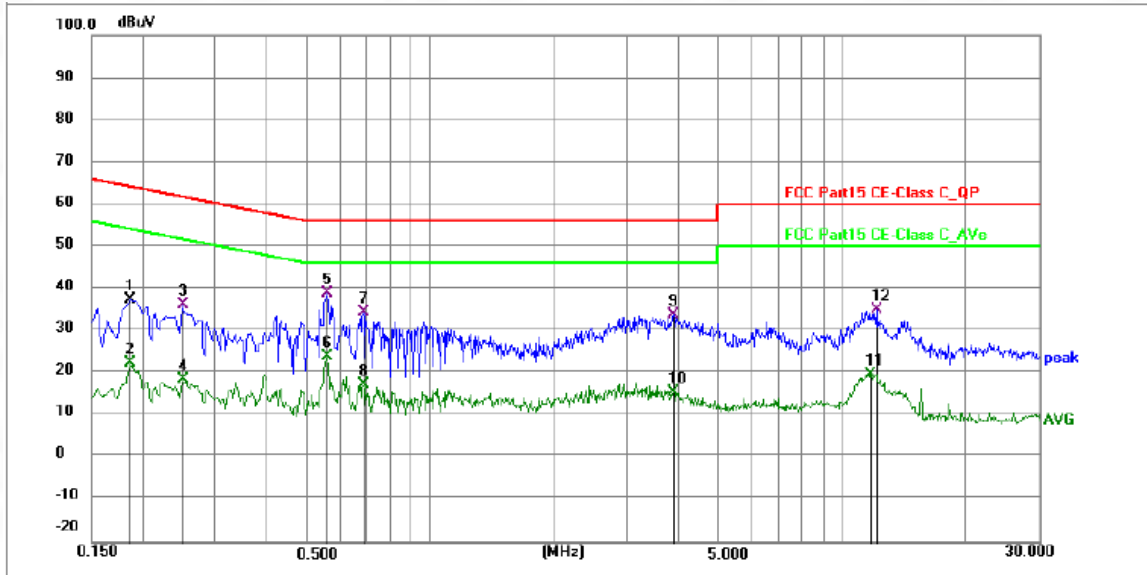

No.	Frequency (MHz)	Reading (dBuV)	Factor (dB)	Level (dBuV)	Limit (dBuV)	Margin (dB)	Detector	P/F	Remark
1	0.1860	26.99	10.53	37.52	64.21	-26.69	peak	P	
2	0.1860	12.03	10.53	22.56	54.21	-31.65	AVG	P	
3	0.2490	25.56	10.56	36.12	61.79	-25.67	QP	P	
4	0.2490	8.00	10.56	18.56	51.79	-33.23	AVG	P	
5 *	0.5594	28.34	10.61	38.95	56.00	-17.05	QP	P	
6	0.5594	13.37	10.61	23.98	46.00	-22.02	AVG	P	
7	0.6854	23.82	10.67	34.49	56.00	-21.51	QP	P	
8	0.6854	6.77	10.67	17.44	46.00	-28.56	AVG	P	
9	3.8894	23.19	10.67	33.86	56.00	-22.14	QP	P	
10	3.8894	4.85	10.67	15.52	46.00	-30.48	AVG	P	
11	11.7014	8.94	10.86	19.80	50.00	-30.20	AVG	P	
12	12.0884	24.17	10.87	35.04	60.00	-24.96	QP	P	

TM1 / Line: Neutral / Band: 2400-2483.5 MHz / BW: 20 / CH: M

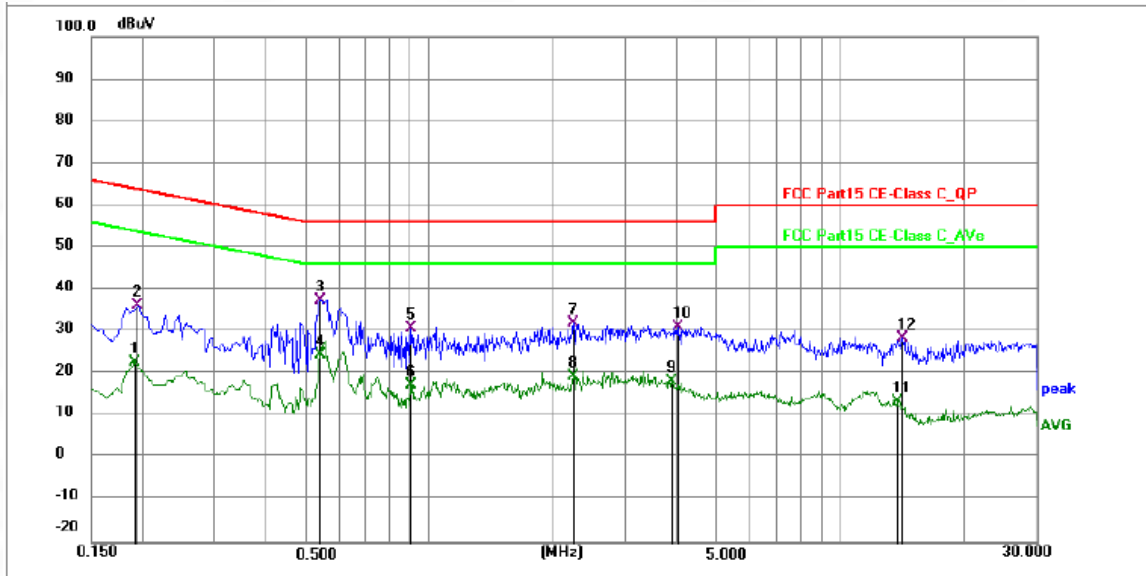

No.	Frequency (MHz)	Reading (dBuV)	Factor (dB)	Level (dBuV)	Limit (dBuV)	Margin (dB)	Detector	P/F	Remark
1	0.1905	12.18	10.54	22.72	54.01	-31.29	AVG	P	
2	0.1949	25.57	10.55	36.12	63.83	-27.71	QP	P	
3 *	0.5415	26.96	10.60	37.56	56.00	-18.44	QP	P	
4	0.5415	13.98	10.60	24.58	46.00	-21.42	AVG	P	
5	0.9015	20.04	10.67	30.71	56.00	-25.29	QP	P	
6	0.9015	6.58	10.67	17.25	46.00	-28.75	AVG	P	
7	2.2380	21.26	10.68	31.94	56.00	-24.06	QP	P	
8	2.2380	8.64	10.68	19.32	46.00	-26.68	AVG	P	
9	3.8940	7.60	10.67	18.27	46.00	-27.73	AVG	P	
10	4.0200	20.62	10.68	31.30	56.00	-24.70	QP	P	
11	13.7220	2.72	10.84	13.56	50.00	-36.44	AVG	P	
12	14.1945	17.50	10.82	28.32	60.00	-31.68	QP	P	

## 6.2 Occupied Bandwidth

Test Requirement:	47 CFR 15.247(a)(2)
Test Method:	ANSI C63.10-2013, section 11.8 KDB 558074 D01 15.247 Meas Guidance v05r02
Test Limit:	Refer to 47 CFR 15.247(a)(2), Systems using digital modulation techniques may operate in the 902-928 MHz, and 2400-2483.5 MHz bands. The minimum 6 dB bandwidth shall be at least 500 kHz.
Procedure:	<ul style="list-style-type: none"> <li>a) Set RBW = 100 kHz.</li> <li>b) Set the VBW <math>\geq</math> <math>[3 \times \text{RBW}]</math>.</li> <li>c) Detector = peak.</li> <li>d) Trace mode = max hold.</li> <li>e) Sweep = auto couple.</li> <li>f) Allow the trace to stabilize.</li> <li>g) Measure the maximum width of the emission that is constrained by the frequencies associated with the two outermost amplitude points (upper and lower frequencies) that are attenuated by 6 dB relative to the maximum level measured in the fundamental emission.</li> </ul>

### 6.2.1 E.U.T. Operation:

Operating Environment:	
Temperature:	24.3 °C
Humidity:	50 %
Atmospheric Pressure:	1010 mbar

### 6.2.2 Test Setup Diagram:

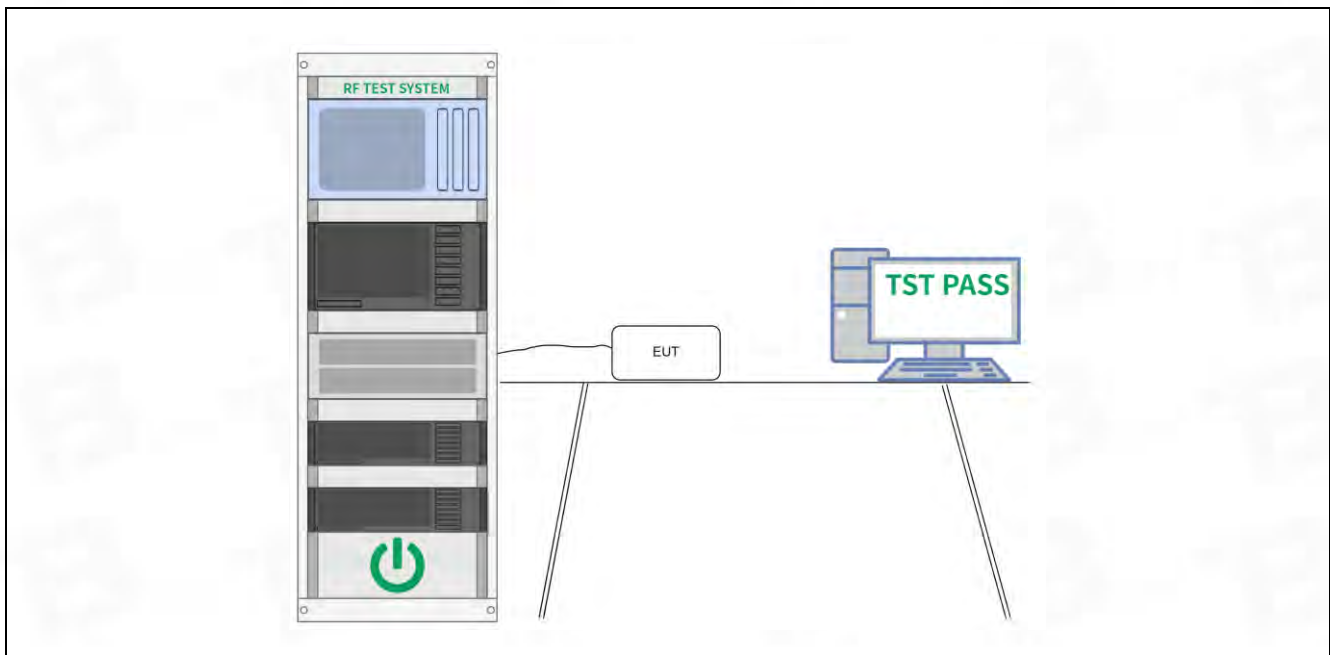

### 6.2.3 Test Data:

Please Refer to Appendix for Details.

### 6.3 Maximum Conducted Output Power

Test Requirement:	47 CFR 15.247(b)(3)
Test Method:	ANSI C63.10-2013, section 11.9.1 KDB 558074 D01 15.247 Meas Guidance v05r02
Test Limit:	Refer to 47 CFR 15.247(b)(3), For systems using digital modulation in the 902-928 MHz, 2400-2483.5 MHz, and 5725-5850 MHz bands: 1 Watt. As an alternative to a peak power measurement, compliance with the one Watt limit can be based on a measurement of the maximum conducted output power. Maximum Conducted Output Power is defined as the total transmit power delivered to all antennas and antenna elements averaged across all symbols in the signaling alphabet when the transmitter is operating at its maximum power control level. Power must be summed across all antennas and antenna elements. The average must not include any time intervals during which the transmitter is off or is transmitting at a reduced power level. If multiple modes of operation are possible (e.g., alternative modulation methods), the maximum conducted output power is the highest total transmit power occurring in any mode.
Procedure:	ANSI C63.10-2013, section 11.9.1 Maximum peak conducted output power

#### 6.3.1 E.U.T. Operation:

Operating Environment:	
Temperature:	24.3 °C
Humidity:	50 %
Atmospheric Pressure:	1010 mbar

#### 6.3.2 Test Setup Diagram:

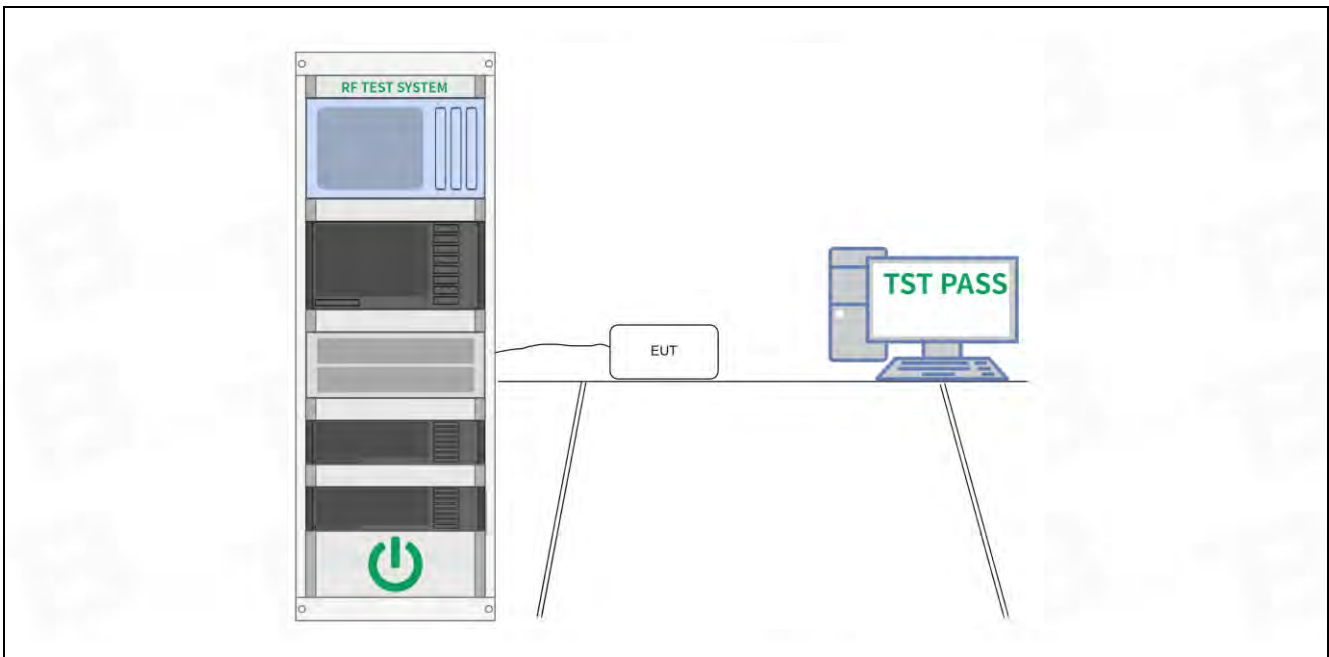

#### 6.3.3 Test Data:

Please Refer to Appendix for Details.



### 6.4 Power Spectral Density

Test Requirement:	47 CFR 15.247(e)
Test Method:	ANSI C63.10-2013, section 11.10 KDB 558074 D01 15.247 Meas Guidance v05r02
Test Limit:	Refer to 47 CFR 15.247(e), For digitally modulated systems, the power spectral density conducted from the intentional radiator to the antenna shall not be greater than 8 dBm in any 3 kHz band during any time interval of continuous transmission. This power spectral density shall be determined in accordance with the provisions of paragraph (b) of this section. The same method of determining the conducted output power shall be used to determine the power spectral density.
Procedure:	ANSI C63.10-2013, section 11.10, Maximum power spectral density level in the fundamental emission

#### 6.4.1 E.U.T. Operation:

Operating Environment:	
Temperature:	24.3 °C
Humidity:	50 %
Atmospheric Pressure:	1010 mbar

#### 6.4.2 Test Setup Diagram:

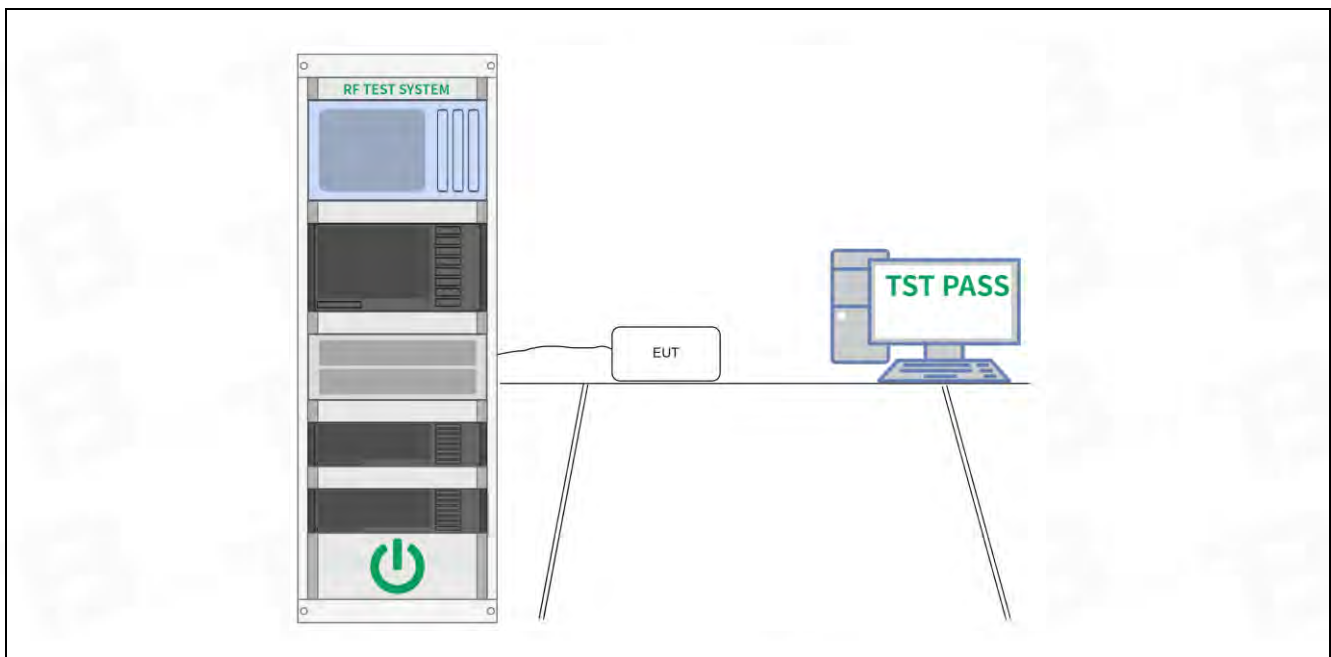

#### 6.4.3 Test Data:

Please Refer to Appendix for Details.

### 6.5 Emissions in non-restricted frequency bands

Test Requirement:	47 CFR 15.247(d), 15.209, 15.205
Test Method:	ANSI C63.10-2013 section 11.11 KDB 558074 D01 15.247 Meas Guidance v05r02
Test Limit:	Refer to 47 CFR 15.247(d), In any 100 kHz bandwidth outside the frequency band in which the spread spectrum or digitally modulated intentional radiator is operating, the radio frequency power that is produced by the intentional radiator shall be at least 20 dB below that in the 100 kHz bandwidth within the band that contains the highest level of the desired power, based on either an RF conducted or a radiated measurement, provided the transmitter demonstrates compliance with the peak conducted power limits. If the transmitter complies with the conducted power limits based on the use of RMS averaging over a time interval, as permitted under paragraph (b)(3) of this section, the attenuation required under this paragraph shall be 30 dB instead of 20 dB. Attenuation below the general limits specified in § 15.209(a) is not required.
Procedure:	ANSI C63.10-2013 Section 11.11.1, Section 11.11.2, Section 11.11.3

#### 6.5.1 E.U.T. Operation:

Operating Environment:	
Temperature:	24.3 °C
Humidity:	50 %
Atmospheric Pressure:	1010 mbar

#### 6.5.2 Test Setup Diagram:

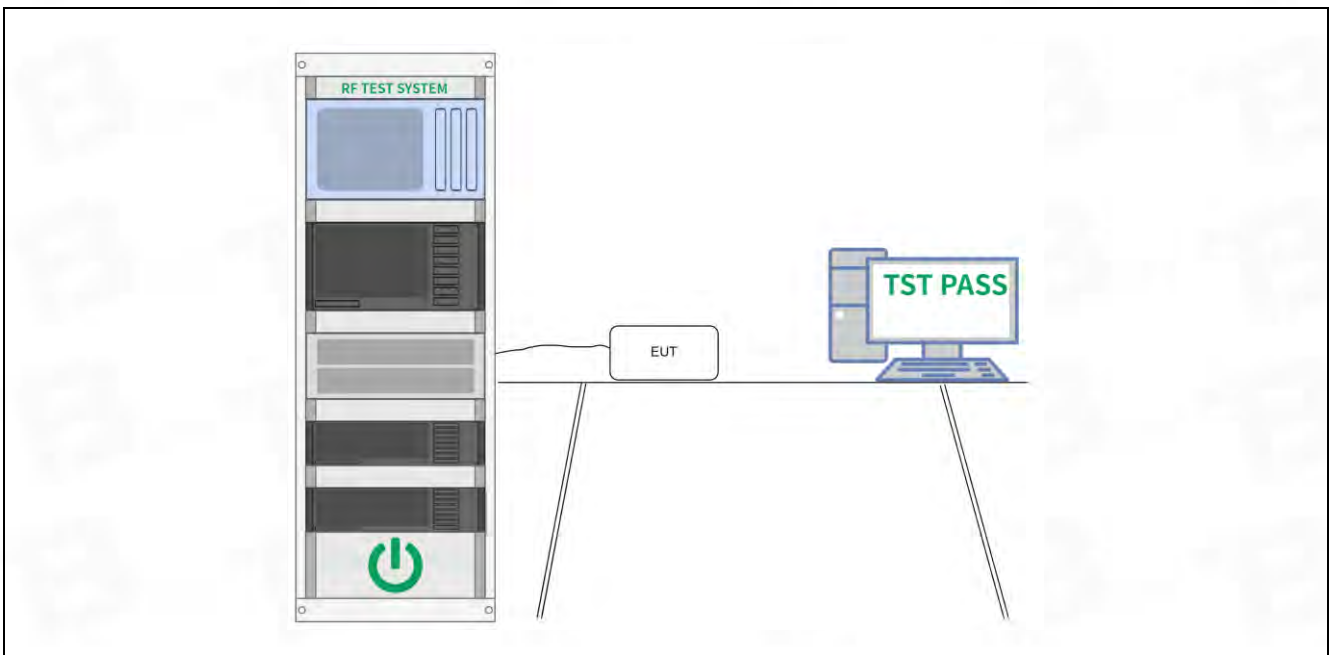

#### 6.5.3 Test Data:

Please Refer to Appendix for Details.

### 6.6 Band edge emissions (Radiated)

Test Requirement:	Refer to 47 CFR 15.247(d), In addition, radiated emissions which fall in the restricted bands, as defined in § 15.205(a), must also comply with the radiated emission limits specified in § 15.209(a)(see § 15.205(c)).		
Test Method:	ANSI C63.10-2013 section 6.10 KDB 558074 D01 15.247 Meas Guidance v05r02		
Test Limit:	Frequency (MHz)	Field strength (microvolts/meter)	Measurement distance (meters)
	0.009-0.490	2400/F(kHz)	300
	0.490-1.705	24000/F(kHz)	30
	1.705-30.0	30	30
	30-88	100 **	3
	88-216	150 **	3
	216-960	200 **	3
	Above 960	500	3
<p>** Except as provided in paragraph (g), fundamental emissions from intentional radiators operating under this section shall not be located in the frequency bands 54-72 MHz, 76-88 MHz, 174-216 MHz or 470-806 MHz. However, operation within these frequency bands is permitted under other sections of this part, e.g., §§ 15.231 and 15.241.</p> <p>In the emission table above, the tighter limit applies at the band edges.</p> <p>The emission limits shown in the above table are based on measurements employing a CISPR quasi-peak detector except for the frequency bands 9–90 kHz, 110–490 kHz and above 1000 MHz. Radiated emission limits in these three bands are based on measurements employing an average detector.</p>			
Procedure:	ANSI C63.10-2013 section 6.10.5.2		

#### 6.6.1 E.U.T. Operation:

Operating Environment:	
Temperature:	22.7 °C
Humidity:	52.3 %
Atmospheric Pressure:	1010 mbar

#### 6.6.2 Test Setup Diagram:

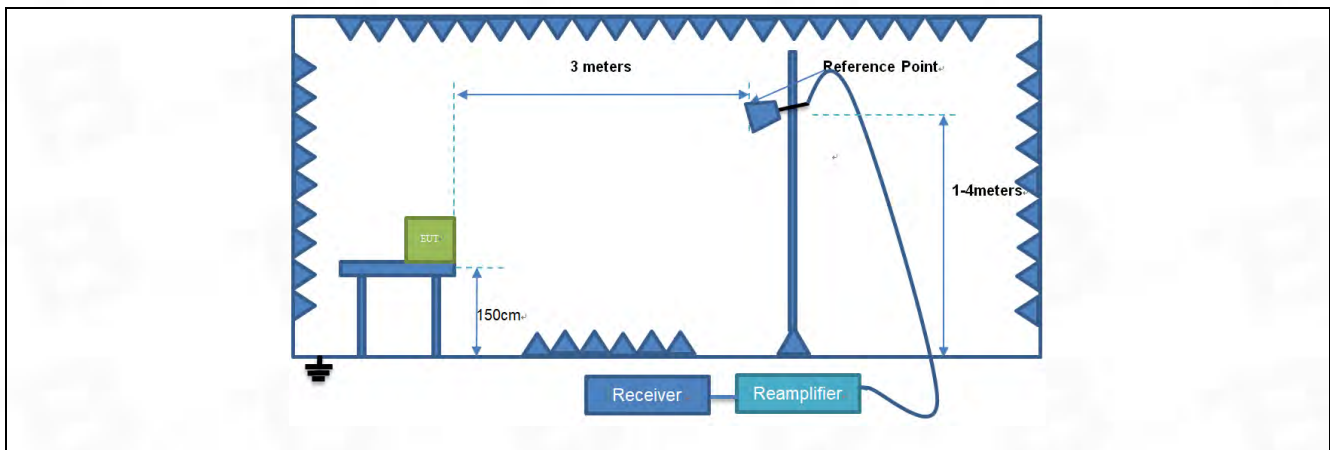

**6.6.3 Test Data:**

TM1 / Polarization: Horizontal / Band: 2400-2483.5 MHz / BW: 20 / CH: L

No.	Frequency (MHz)	Reading Level(dBuV)	Factor (dB)	Level (dBuV/m)	Limit (dBuV/m)	Margin (dB)	Detector
1	2310.00	61.62	3.39	65.01	74.00	-8.99	peak
2	2310.00	42.36	3.39	45.75	54.00	-8.25	AV
3	2390.00	62.08	3.45	65.53	74.00	-8.47	peak
4	2390.00	41.32	3.45	44.77	54.00	-9.23	AV

TM1 / Polarization: Vertical / Band: 2400-2483.5 MHz / BW: 20 / CH: L

No.	Frequency (MHz)	Reading Level(dBuV)	Factor (dB)	Level (dBuV/m)	Limit (dBuV/m)	Margin (dB)	Detector
1	2310.00	60.20	3.39	63.59	74.00	-10.41	peak
2	2310.00	42.36	3.39	45.75	54.00	-8.25	AV
3	2390.00	61.44	3.45	64.89	74.00	-9.11	peak
4	2390.00	41.32	3.45	44.77	54.00	-9.23	AV

TM1 / Polarization: Horizontal / Band: 2400-2483.5 MHz / BW: 20 / CH: H

No.	Frequency (MHz)	Reading Level(dBuV)	Factor (dB)	Level (dBuV/m)	Limit (dBuV/m)	Margin (dB)	Detector
1	2483.50	62.75	3.52	66.27	74.00	-7.73	peak
2	2483.50	41.36	3.52	44.88	54.00	-9.12	AV
3	2500.00	60.29	3.53	63.82	74.00	-10.18	peak
4	2500.00	41.96	3.53	45.49	54.00	-8.51	AV

TM1 / Polarization: Vertical / Band: 2400-2483.5 MHz / BW: 20 / CH: H

No.	Frequency (MHz)	Reading Level(dBuV)	Factor (dB)	Level (dBuV/m)	Limit (dBuV/m)	Margin (dB)	Detector
1	2483.50	61.99	3.52	65.51	74.00	-8.49	peak
2	2483.50	42.01	3.52	45.53	54.00	-8.47	AV
3	2500.00	60.51	3.53	64.04	74.00	-9.96	peak
4	2500.00	40.98	3.53	44.51	54.00	-9.49	AV

### 6.7 Emissions in frequency bands (below 1GHz)

Test Requirement:	Refer to 47 CFR 15.247(d), In addition, radiated emissions which fall in the restricted bands, as defined in § 15.205(a), must also comply with the radiated emission limits specified in § 15.209(a)(see § 15.205(c)).`		
Test Method:	ANSI C63.10-2013 section 6.6.4 KDB 558074 D01 15.247 Meas Guidance v05r02		
Test Limit:	Frequency (MHz)	Field strength (microvolts/meter)	Measurement distance (meters)
	0.009-0.490	2400/F(kHz)	300
	0.490-1.705	24000/F(kHz)	30
	1.705-30.0	30	30
	30-88	100 **	3
	88-216	150 **	3
	216-960	200 **	3
	Above 960	500	3
Procedure:	ANSI C63.10-2013 section 6.6.4		

\*\* Except as provided in paragraph (g), fundamental emissions from intentional radiators operating under this section shall not be located in the frequency bands 54-72 MHz, 76-88 MHz, 174-216 MHz or 470-806 MHz. However, operation within these frequency bands is permitted under other sections of this part, e.g., §§ 15.231 and 15.241.  
In the emission table above, the tighter limit applies at the band edges.  
The emission limits shown in the above table are based on measurements employing a CISPR quasi-peak detector except for the frequency bands 9–90 kHz, 110–490 kHz and above 1000 MHz. Radiated emission limits in these three bands are based on measurements employing an average detector.

#### 6.7.1 E.U.T. Operation:

Operating Environment:	
Temperature:	22.7 °C
Humidity:	52.3 %
Atmospheric Pressure:	1010 mbar

#### 6.7.2 Test Setup Diagram:

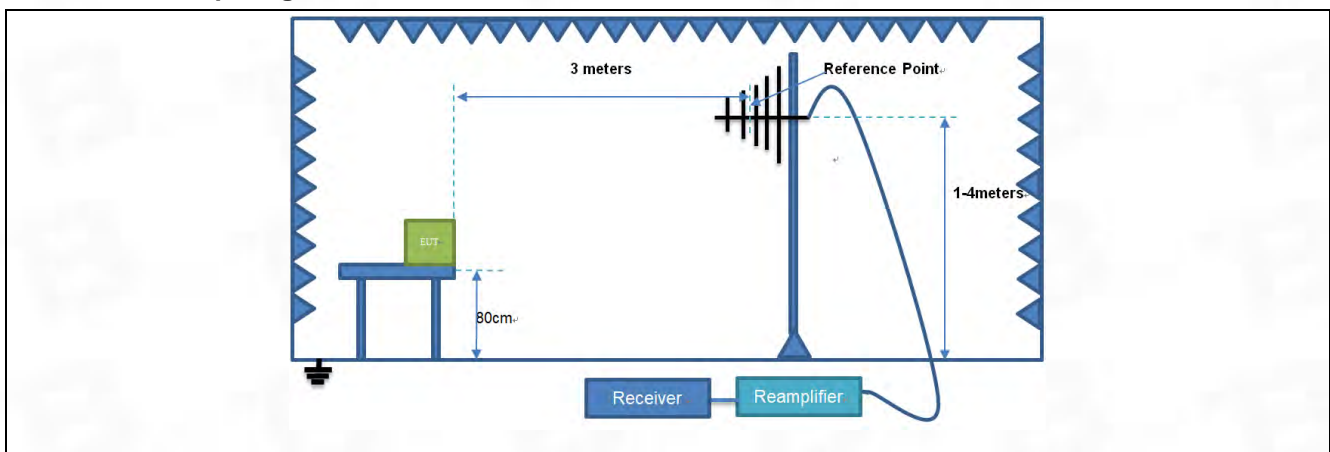

6.7.3 Test Data:

TM1 / Polarization: Horizontal / Band: 2400-2483.5 MHz / BW: 20 / CH: M

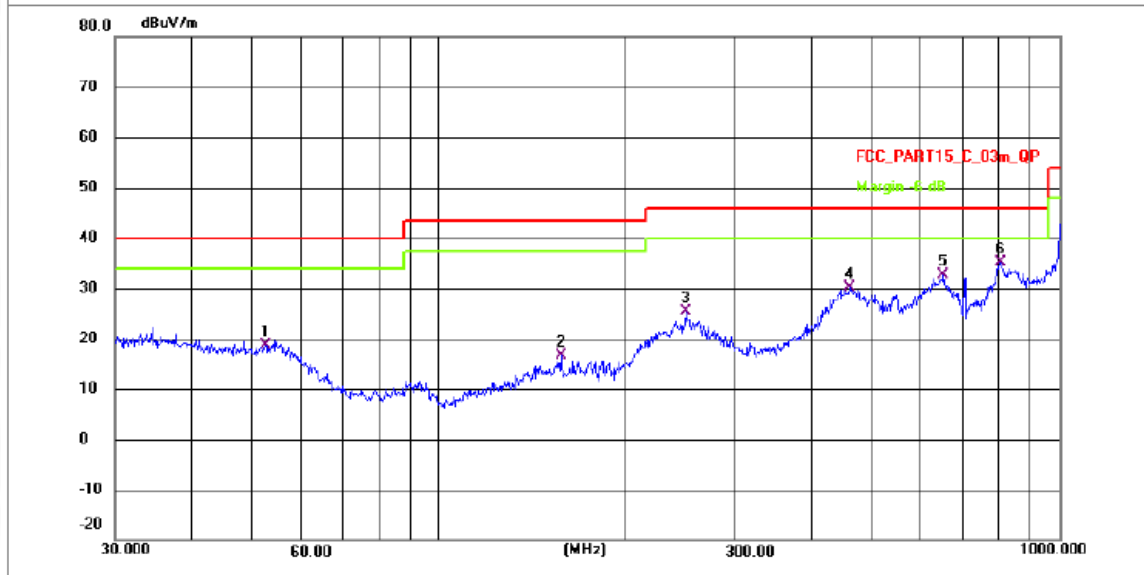

No.	Frequency (MHz)	Reading (dBuV)	Factor (dB/m)	Level (dBuV/m)	Limit (dBuV/m)	Margin (dB)	Detector	P/F
1	52.4832	20.18	-1.54	18.64	40.00	-21.36	QP	P
2	157.2828	36.24	-19.63	16.61	43.50	-26.89	QP	P
3	249.8627	33.92	-8.63	25.29	46.00	-20.71	QP	P
4	459.1144	36.48	-6.27	30.21	46.00	-15.79	QP	P
5	650.7997	41.19	-8.61	32.58	46.00	-13.42	QP	P
6 *	807.4290	44.16	-8.92	35.24	46.00	-10.76	QP	P

TM1 / Polarization: Vertical / Band: 2400-2483.5 MHz / BW: 20 / CH: M

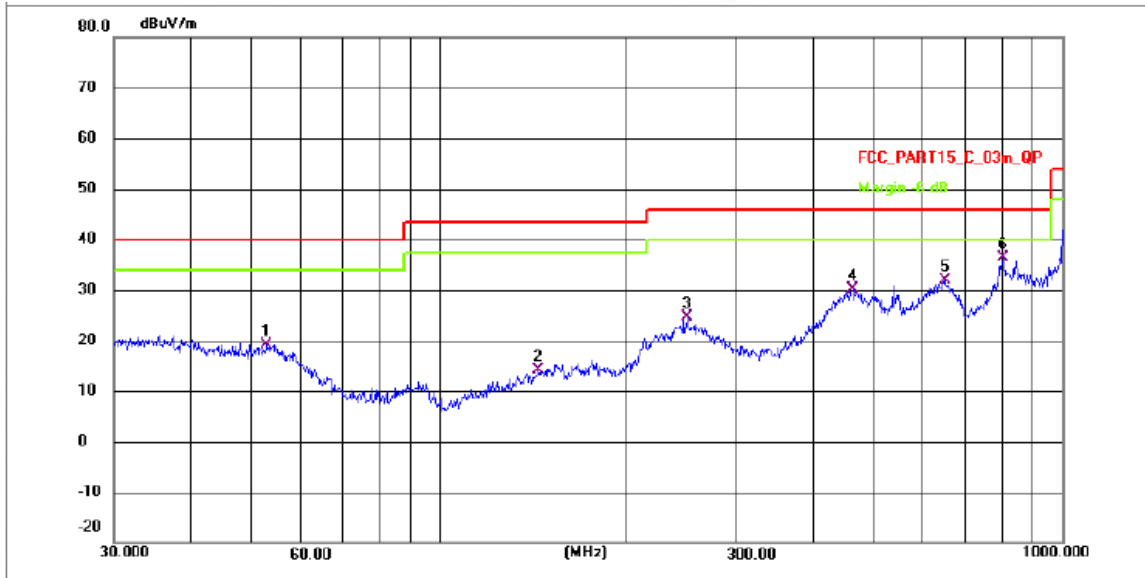

No.	Frequency (MHz)	Reading (dBuV)	Factor (dB/m)	Level (dBuV/m)	Limit (dBuV/m)	Margin (dB)	Detector	P/F
1	52.8525	22.64	-3.51	19.13	40.00	-20.87	QP	P
2	144.3347	34.61	-20.57	14.04	43.50	-29.46	QP	P
3	250.7404	33.24	-8.70	24.54	46.00	-21.46	QP	P
4	462.3455	36.79	-6.54	30.25	46.00	-15.75	QP	P
5	649.6596	40.31	-8.52	31.79	46.00	-14.21	QP	P
6 *	806.0146	45.20	-8.92	36.28	46.00	-9.72	QP	P

### 6.8 Emissions in frequency bands (above 1GHz)

Test Requirement:	In addition, radiated emissions which fall in the restricted bands, as defined in § 15.205(a), must also comply with the radiated emission limits specified in § 15.209(a)(see § 15.205(c)).		
Test Method:	ANSI C63.10-2013 section 6.6.4 KDB 558074 D01 15.247 Meas Guidance v05r02		
Test Limit:	Frequency (MHz)	Field strength (microvolts/meter)	Measurement distance (meters)
	0.009-0.490	2400/F(kHz)	300
	0.490-1.705	24000/F(kHz)	30
	1.705-30.0	30	30
	30-88	100 **	3
	88-216	150 **	3
	216-960	200 **	3
	Above 960	500	3
<p>** Except as provided in paragraph (g), fundamental emissions from intentional radiators operating under this section shall not be located in the frequency bands 54-72 MHz, 76-88 MHz, 174-216 MHz or 470-806 MHz. However, operation within these frequency bands is permitted under other sections of this part, e.g., §§ 15.231 and 15.241.</p> <p>In the emission table above, the tighter limit applies at the band edges.</p> <p>The emission limits shown in the above table are based on measurements employing a CISPR quasi-peak detector except for the frequency bands 9–90 kHz, 110–490 kHz and above 1000 MHz. Radiated emission limits in these three bands are based on measurements employing an average detector.</p>			
Procedure:	ANSI C63.10-2013 section 6.6.4		

#### 6.8.1 E.U.T. Operation:

Operating Environment:	
Temperature:	22.7 °C
Humidity:	52.3 %
Atmospheric Pressure:	1010 mbar

#### 6.8.2 Test Setup Diagram:

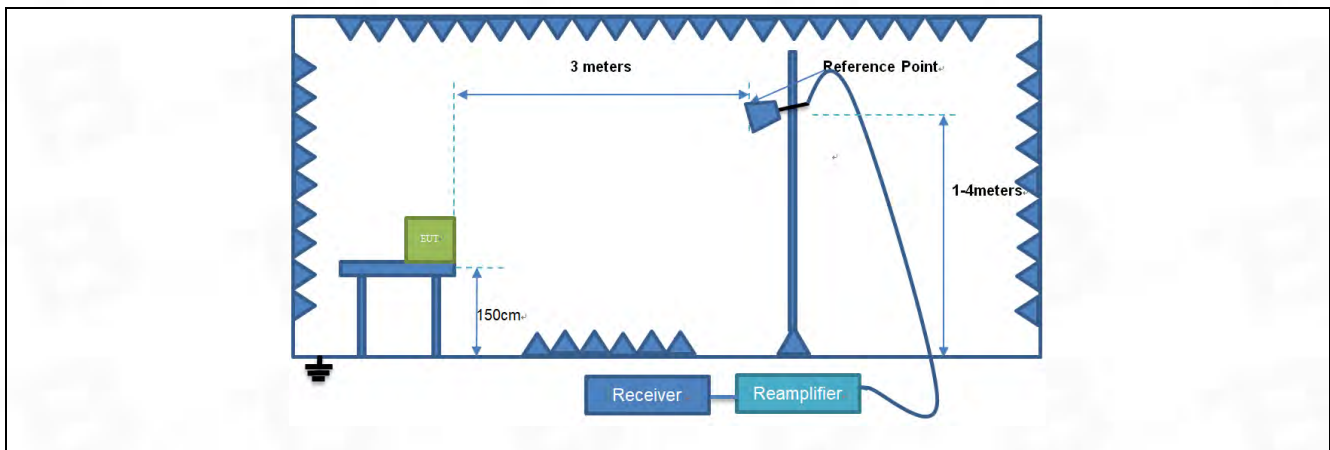



**6.8.3 Test Data:**

TM1 / Polarization: Horizontal / Band: 2400-2483.5 MHz / BW: 20 / CH: L

No.	Frequency (MHz)	Reading (dBuV)	Factor (dB/m)	Level (dBuV/m)	Limit (dBuV/m)	Margin (dB)	Detector	P/F
1	4824.000	83.58	-49.34	34.24	74.00	-39.76	peak	P
2	7236.000	87.93	-47.51	40.42	74.00	-33.58	peak	P
3	9648.000	86.02	-45.91	40.11	74.00	-33.89	peak	P

TM1 / Polarization: Vertical / Band: 2400-2483.5 MHz / BW: 20 / CH: L

No.	Frequency (MHz)	Reading (dBuV)	Factor (dB/m)	Level (dBuV/m)	Limit (dBuV/m)	Margin (dB)	Detector	P/F
1	4824.000	82.25	-49.34	32.91	74.00	-41.09	peak	P
2	7236.000	88.21	-47.51	40.70	74.00	-33.30	peak	P
3	9648.000	87.12	-45.91	41.21	74.00	-32.79	peak	P

TM1 / Polarization: Horizontal / Band: 2400-2483.5 MHz / BW: 20 / CH: M

No.	Frequency (MHz)	Reading (dBuV)	Factor (dB/m)	Level (dBuV/m)	Limit (dBuV/m)	Margin (dB)	Detector	P/F
1	4874.000	83.02	-49.34	33.68	74.00	-40.32	peak	P
2	7311.000	87.37	-47.51	39.86	74.00	-34.14	peak	P
3	9748.000	85.46	-45.91	39.55	74.00	-34.45	peak	P

TM1 / Polarization: Vertical / Band: 2400-2483.5 MHz / BW: 20 / CH: M

No.	Frequency (MHz)	Reading (dBuV)	Factor (dB/m)	Level (dBuV/m)	Limit (dBuV/m)	Margin (dB)	Detector	P/F
1	4874.000	81.69	-49.34	32.35	74.00	-41.65	peak	P
2	7311.000	87.65	-47.51	40.14	74.00	-33.86	peak	P
3	9748.000	86.56	-45.91	40.65	74.00	-33.35	peak	P

TM1 / Polarization: Horizontal / Band: 2400-2483.5 MHz / BW: 20 / CH: H

No.	Frequency (MHz)	Reading (dBuV)	Factor (dB/m)	Level (dBuV/m)	Limit (dBuV/m)	Margin (dB)	Detector	P/F
1	4924.000	84.04	-49.22	34.82	74.00	-39.18	peak	P
2	7386.000	88.39	-47.39	41.00	74.00	-33.00	peak	P
3	9848.000	86.48	-45.79	40.69	74.00	-33.31	peak	P

TM1 / Polarization: Vertical / Band: 2400-2483.5 MHz / BW: 20 / CH: H

No.	Frequency (MHz)	Reading (dBuV)	Factor (dB/m)	Level (dBuV/m)	Limit (dBuV/m)	Margin (dB)	Detector	P/F
1	4924.000	82.65	-49.22	33.43	74.00	-40.57	peak	P
2	7386.000	88.61	-47.39	41.22	74.00	-32.78	peak	P
3	9848.000	87.52	-45.79	41.73	74.00	-32.27	peak	P

## 7 Test Setup Photos

Conducted Emission at AC power line

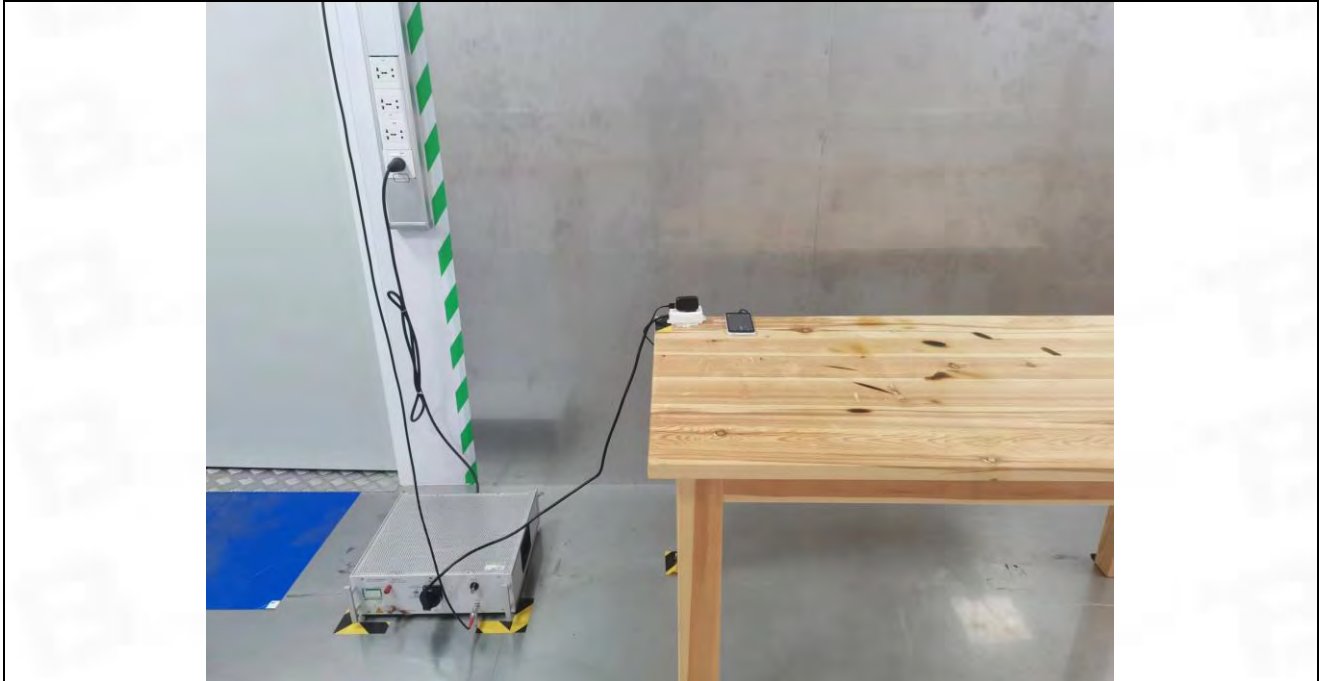

Band edge emissions (Radiated)  
Emissions in frequency bands (above 1GHz)



Emissions in frequency bands (below 1GHz)

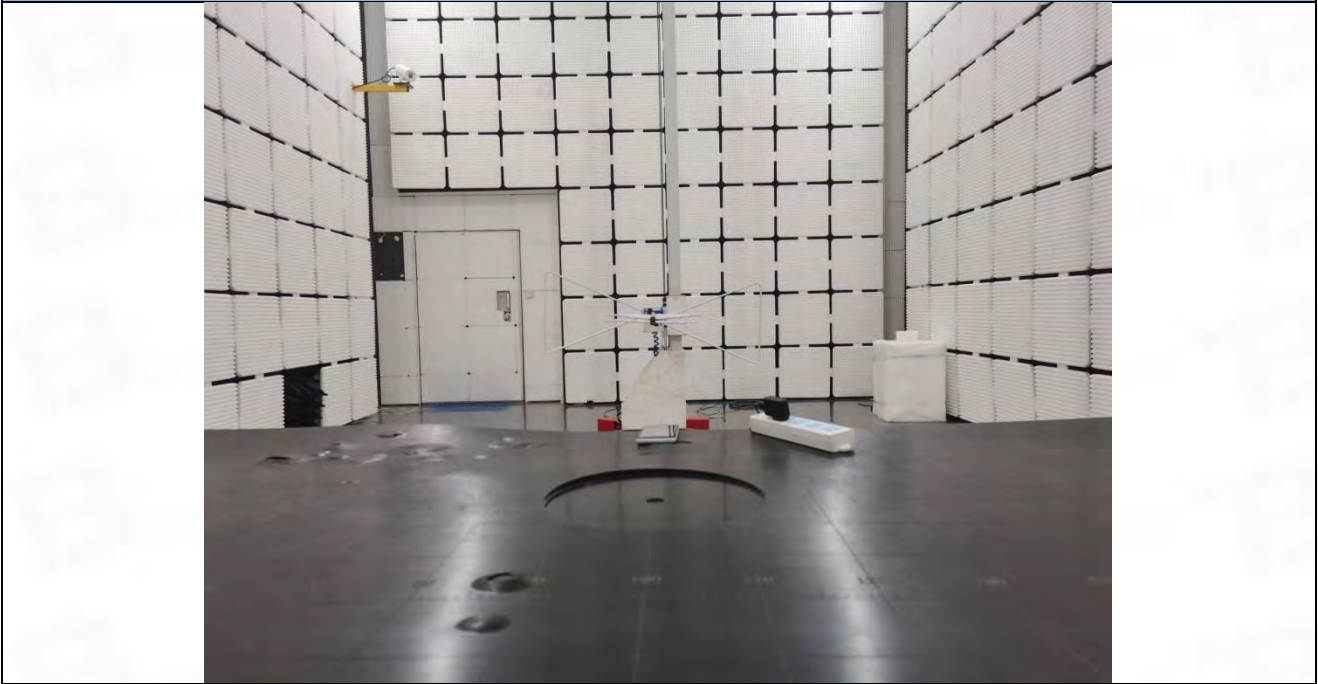

## 8 EUT Constructional Details (EUT Photos)

Please refer to the test report No. BTF240419R00901

# Appendix

## 1. Duty Cycle

### 1.1 Ant1

#### 1.1.1 Test Result

Ant1							
Mode	TX Type	Frequency (MHz)	T_on (ms)	Period (ms)	Duty Cycle (%)	Duty Cycle Correction Factor (dB)	Max. DC Variation (%)
802.11b	SISO	2412	8.383	8.413	99.64	0.02	0.00
		2437	8.383	8.413	99.64	0.02	0.04
		2462	8.383	8.413	99.64	0.02	0.00
802.11g	SISO	2412	1.393	1.428	97.55	0.11	0.03
		2437	1.393	1.428	97.55	0.11	0.03
		2462	1.393	1.428	97.55	0.11	0.03
802.11n (HT20)	SISO	2412	1.300	1.335	97.38	0.12	0.03
		2437	1.302	1.336	97.46	0.11	0.03
		2462	1.301	1.336	97.38	0.12	0.03
802.11n (HT40)	SISO	2422	0.649	0.683	95.02	0.22	0.03
		2437	0.649	0.683	95.02	0.22	0.03
		2452	0.649	0.683	95.02	0.22	0.03

1.1.2 Test Graph

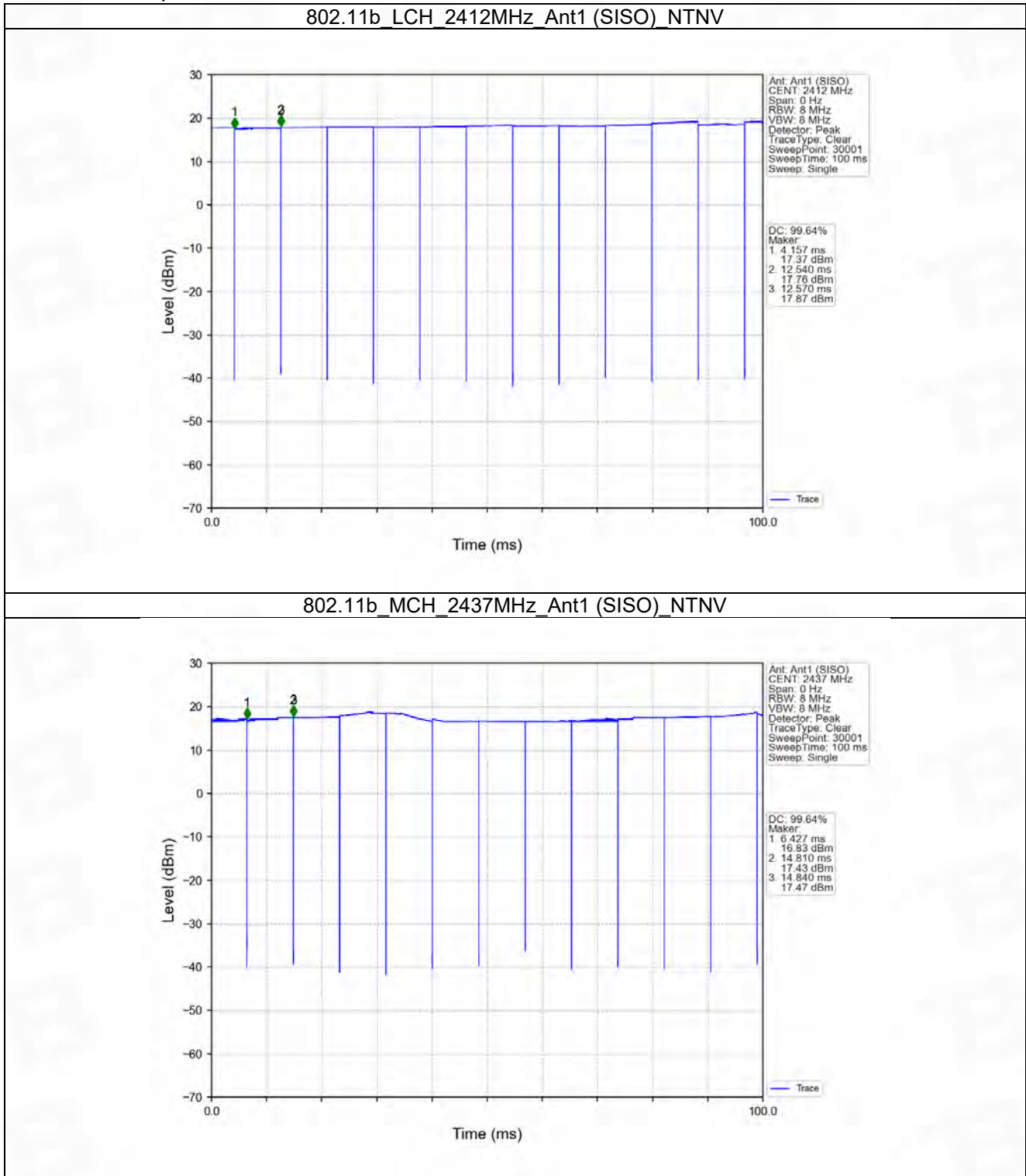



802.11b\_HCH\_2462MHz\_Ant1 (SISO)\_NTNV

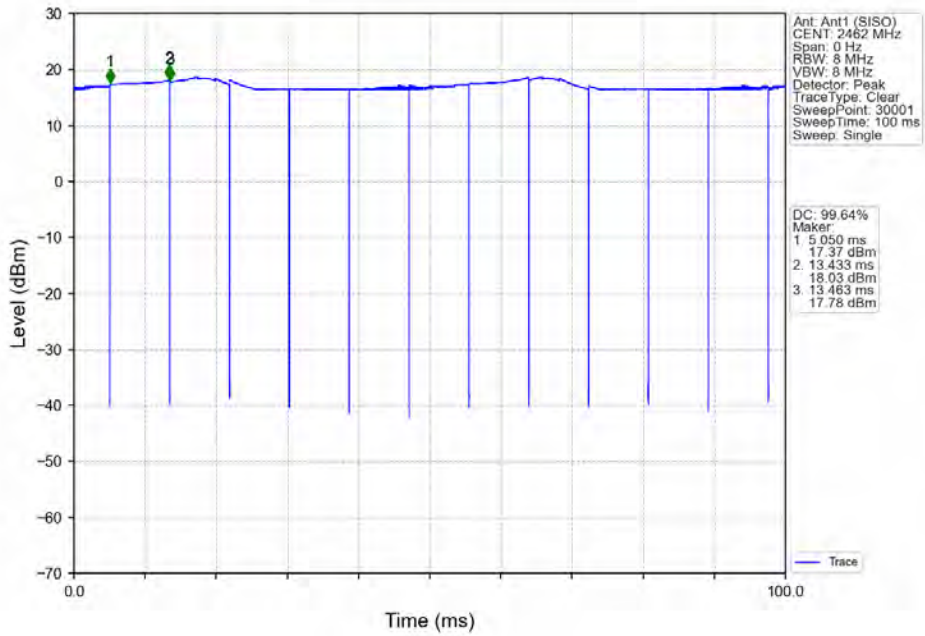

802.11g\_LCH\_2412MHz\_Ant1 (SISO)\_NTNV

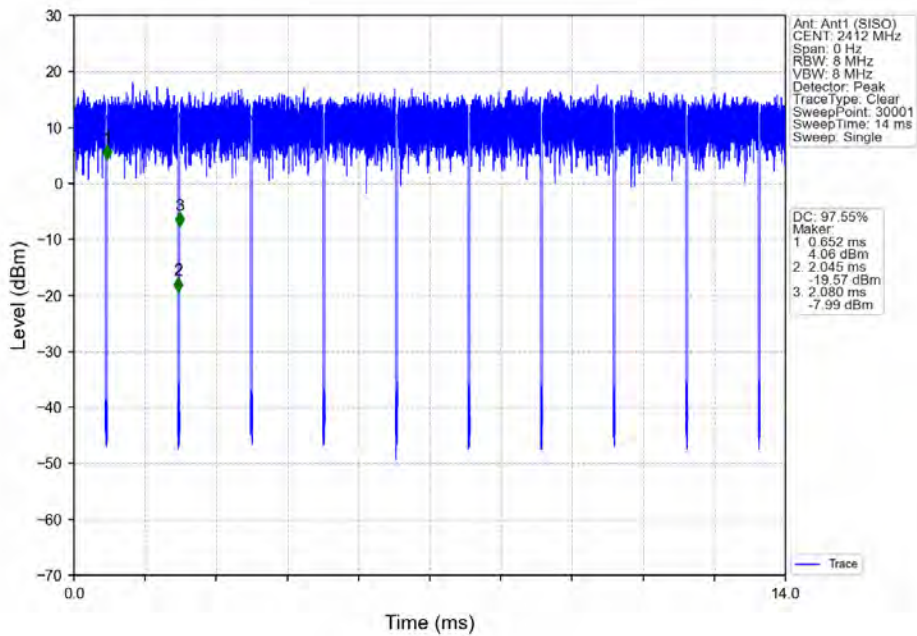

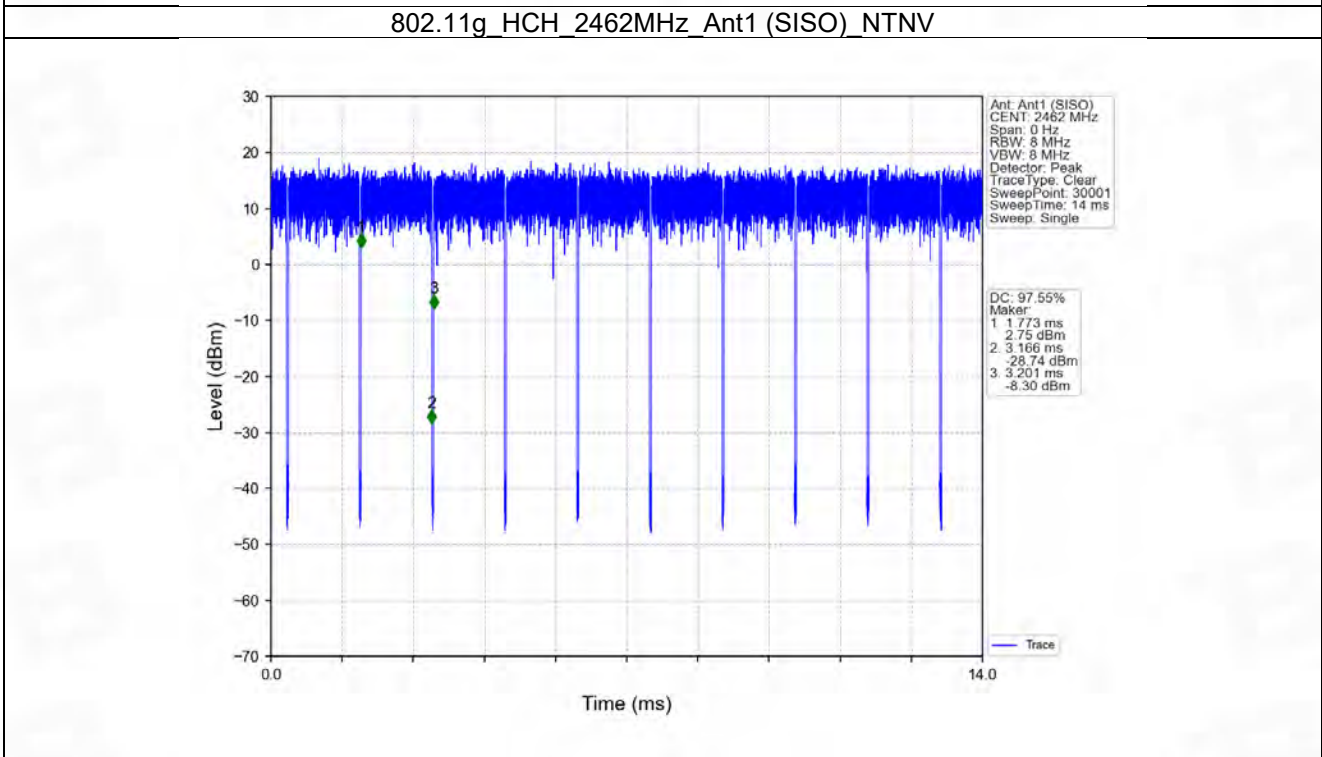
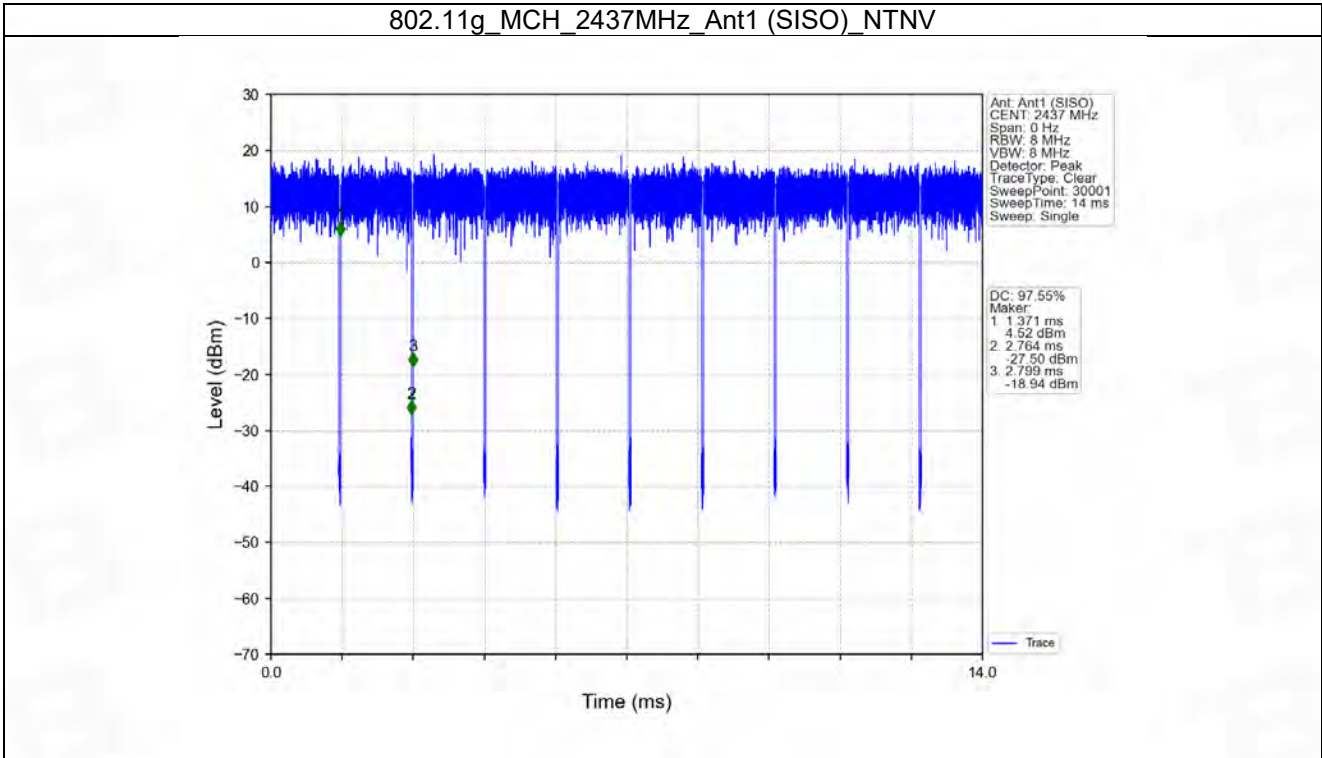

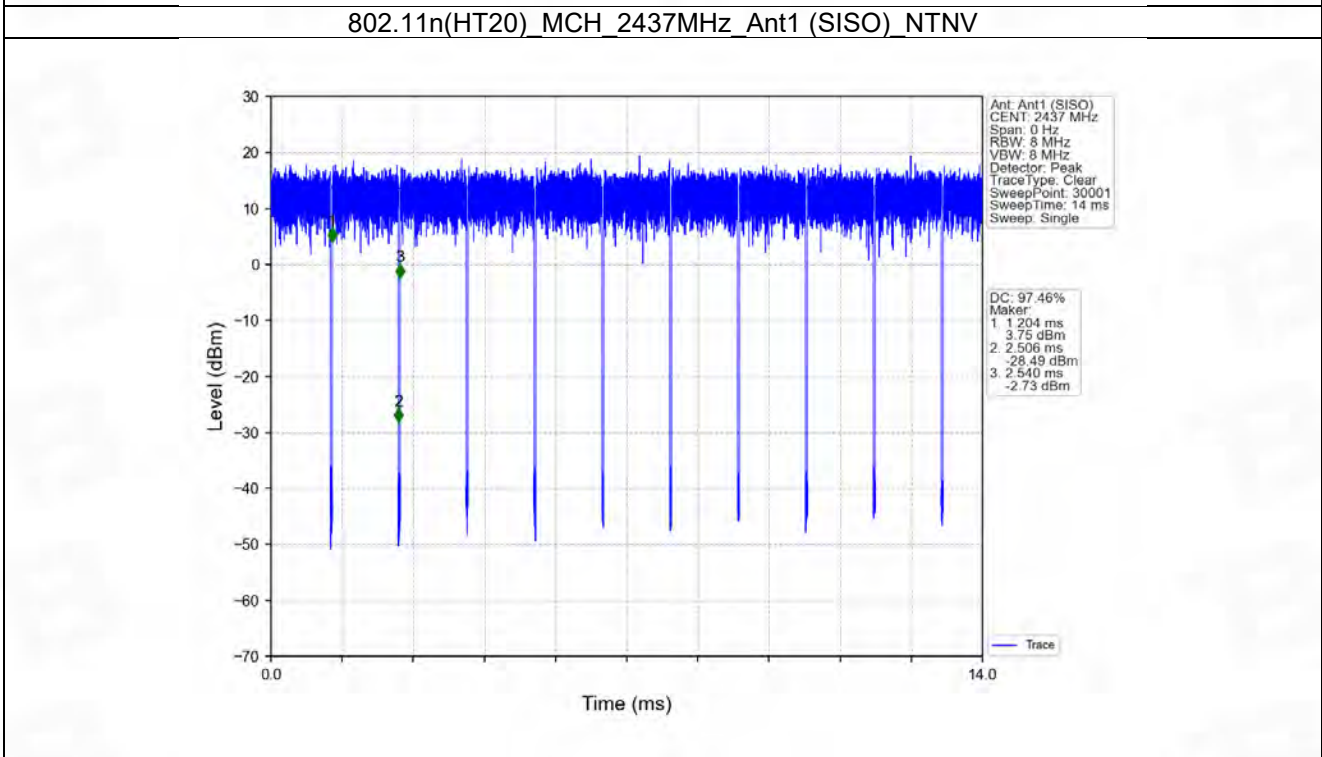
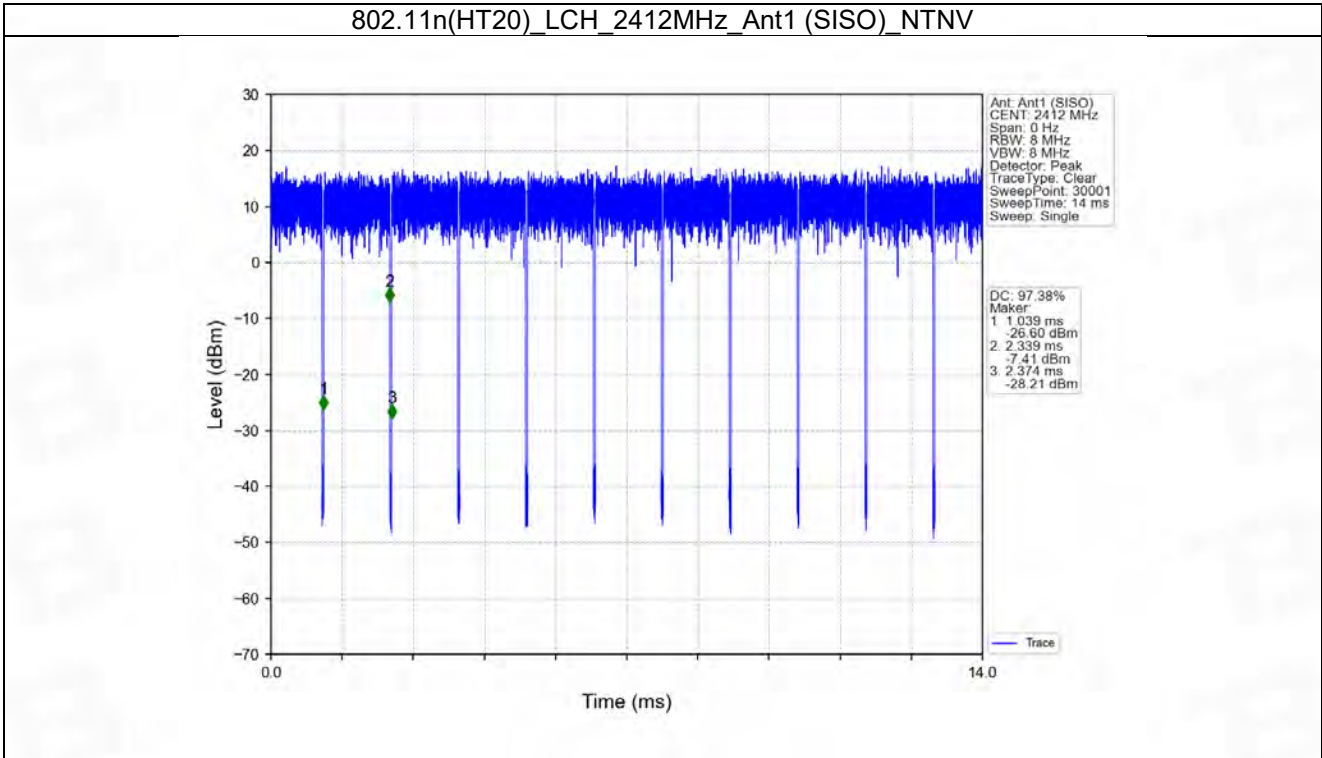

802.11n(HT20)\_HCH\_2462MHz\_Ant1 (SISO)\_NTNV

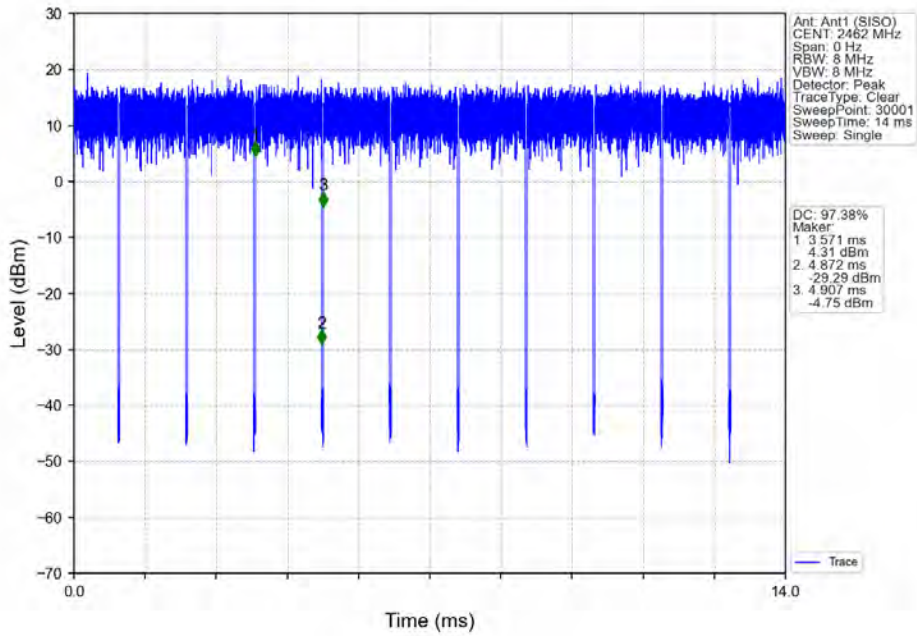

802.11n(HT40)\_LCH\_2422MHz\_Ant1 (SISO)\_NTNV

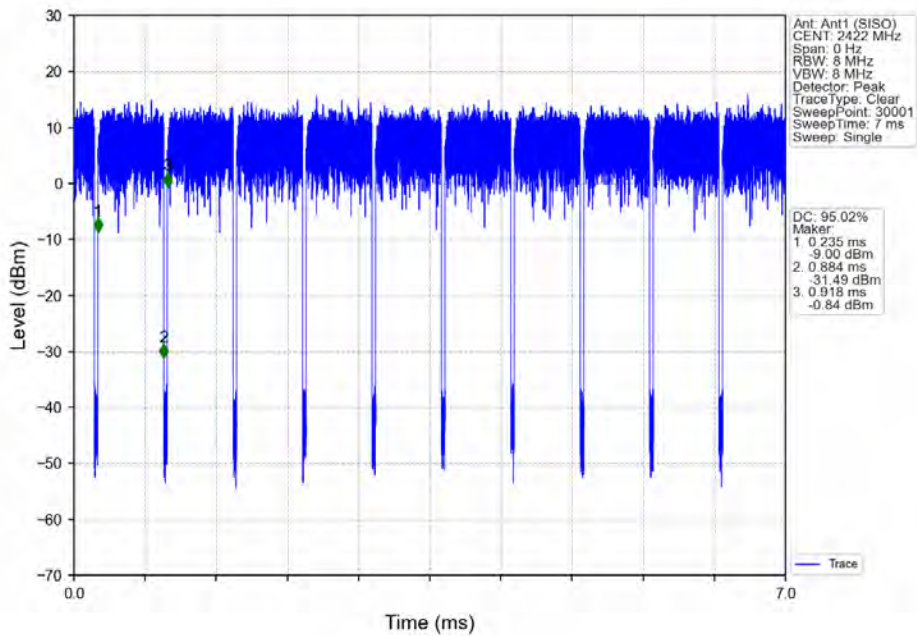

802.11n(HT40)\_MCH\_2437MHz\_Ant1 (SISO)\_NTNV

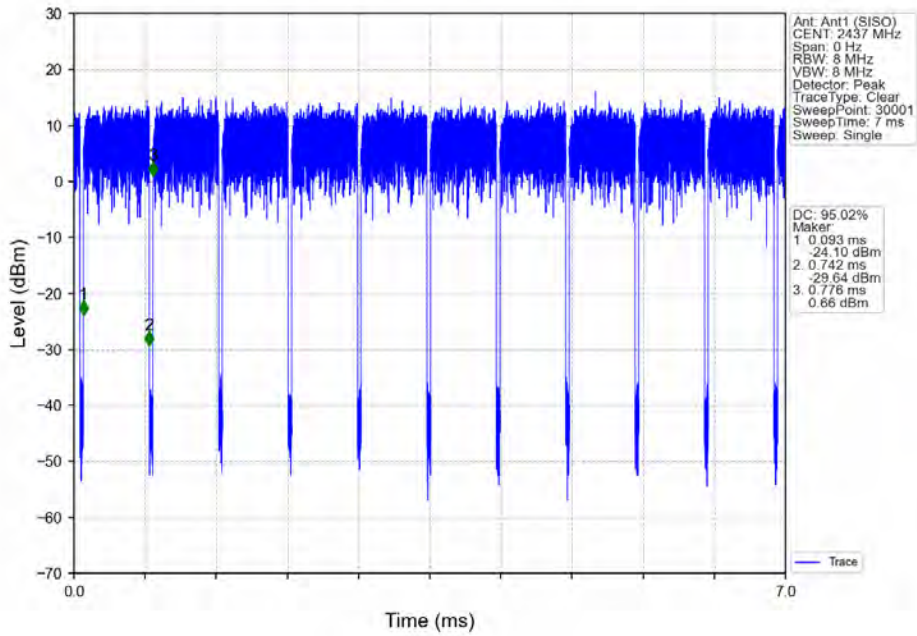

802.11n(HT40)\_HCH\_2452MHz\_Ant1 (SISO)\_NTNV

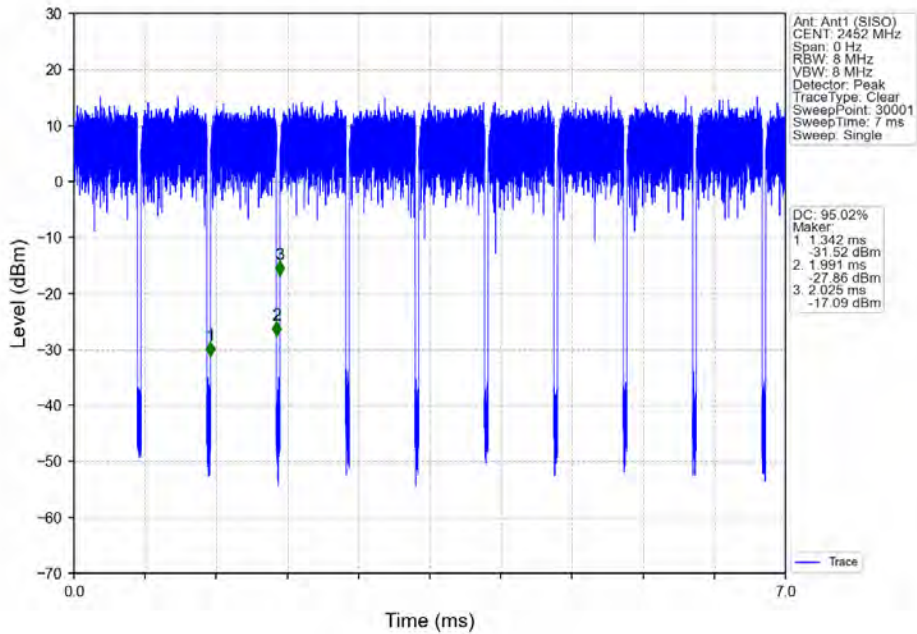

## 2. Bandwidth

### 2.1 OBW

#### 2.1.1 Test Result

Mode	TX Type	Frequency (MHz)	ANT	99% Occupied Bandwidth (MHz)		Verdict
				Result	Limit	
802.11b	SISO	2412	1	12.492	/	Pass
		2437	1	12.464	/	Pass
		2462	1	12.476	/	Pass
802.11g	SISO	2412	1	17.416	/	Pass
		2437	1	17.470	/	Pass
		2462	1	17.484	/	Pass
802.11n (HT20)	SISO	2412	1	18.086	/	Pass
		2437	1	18.136	/	Pass
		2462	1	18.227	/	Pass
802.11n (HT40)	SISO	2422	1	36.536	/	Pass
		2437	1	36.495	/	Pass
		2452	1	36.505	/	Pass

### 2.1.2 Test Graph

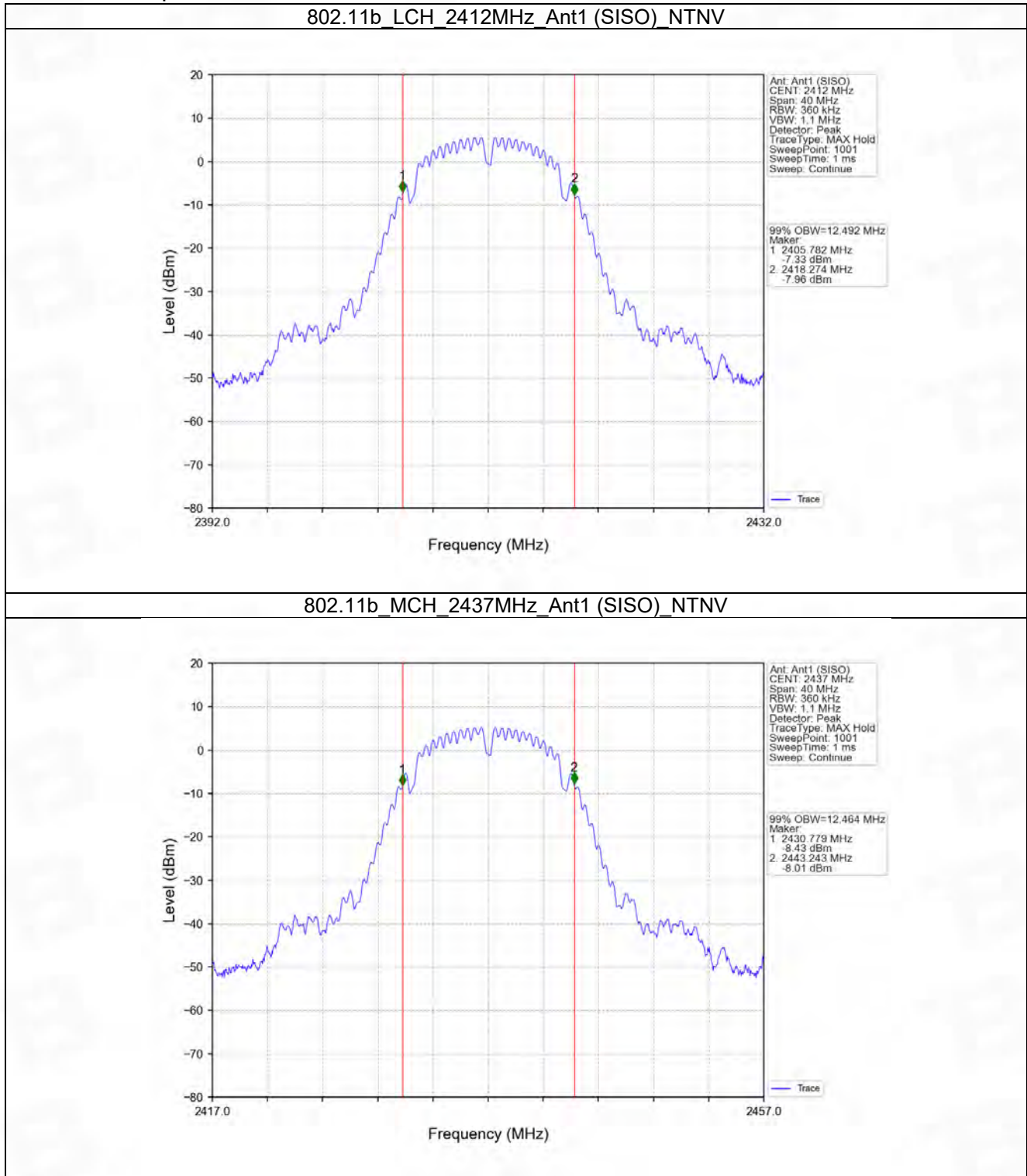

802.11b\_HCH\_2462MHz\_Ant1 (SISO)\_NTNV

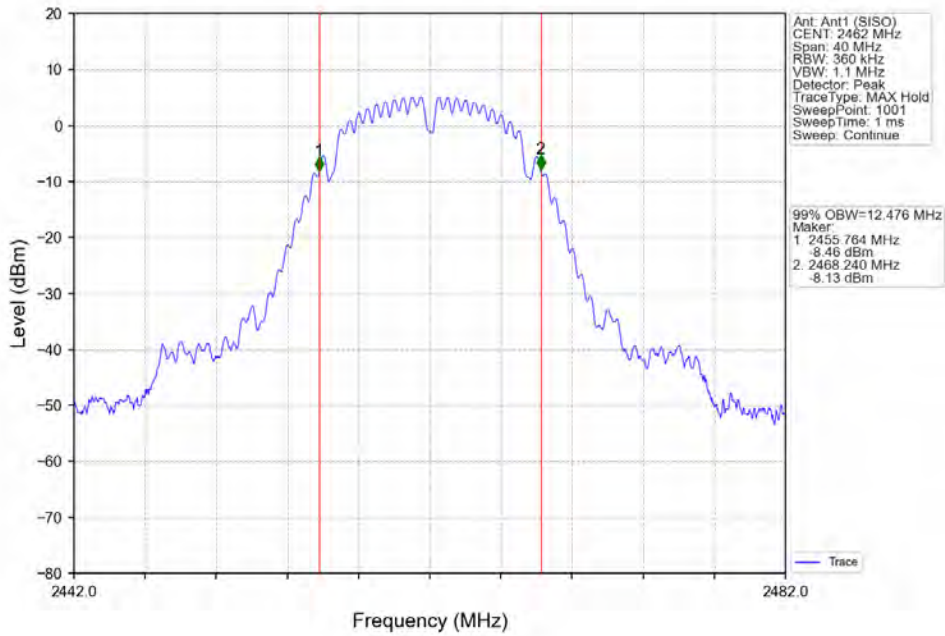

802.11g\_LCH\_2412MHz\_Ant1 (SISO)\_NTNV

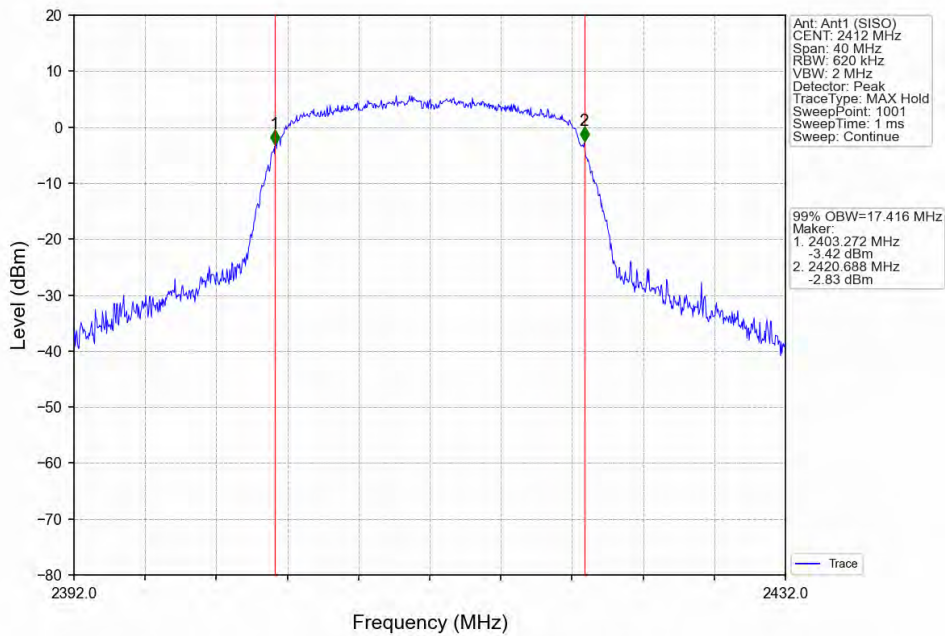



802.11g\_MCH\_2437MHz\_Ant1 (SISO)\_NTNV

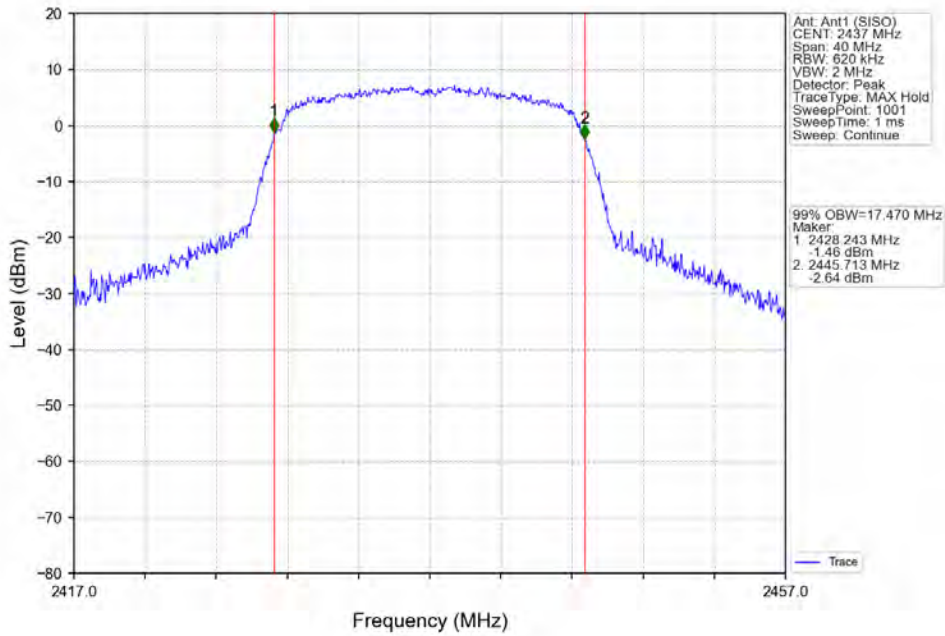

802.11g\_HCH\_2462MHz\_Ant1 (SISO)\_NTNV

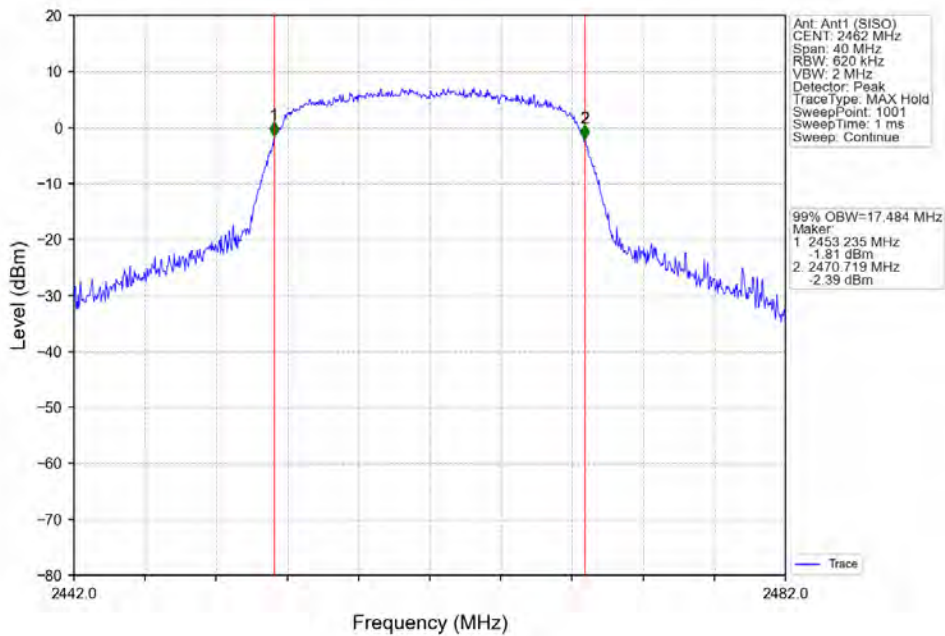

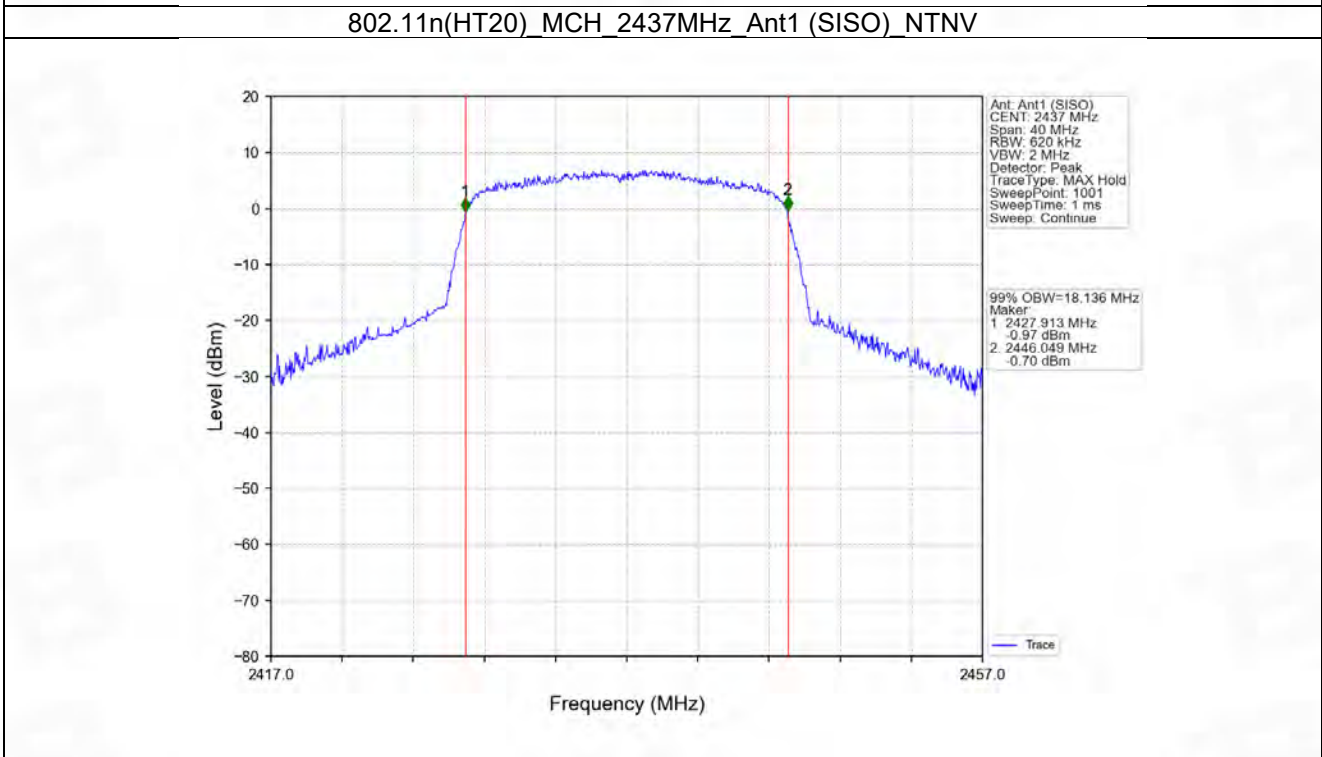
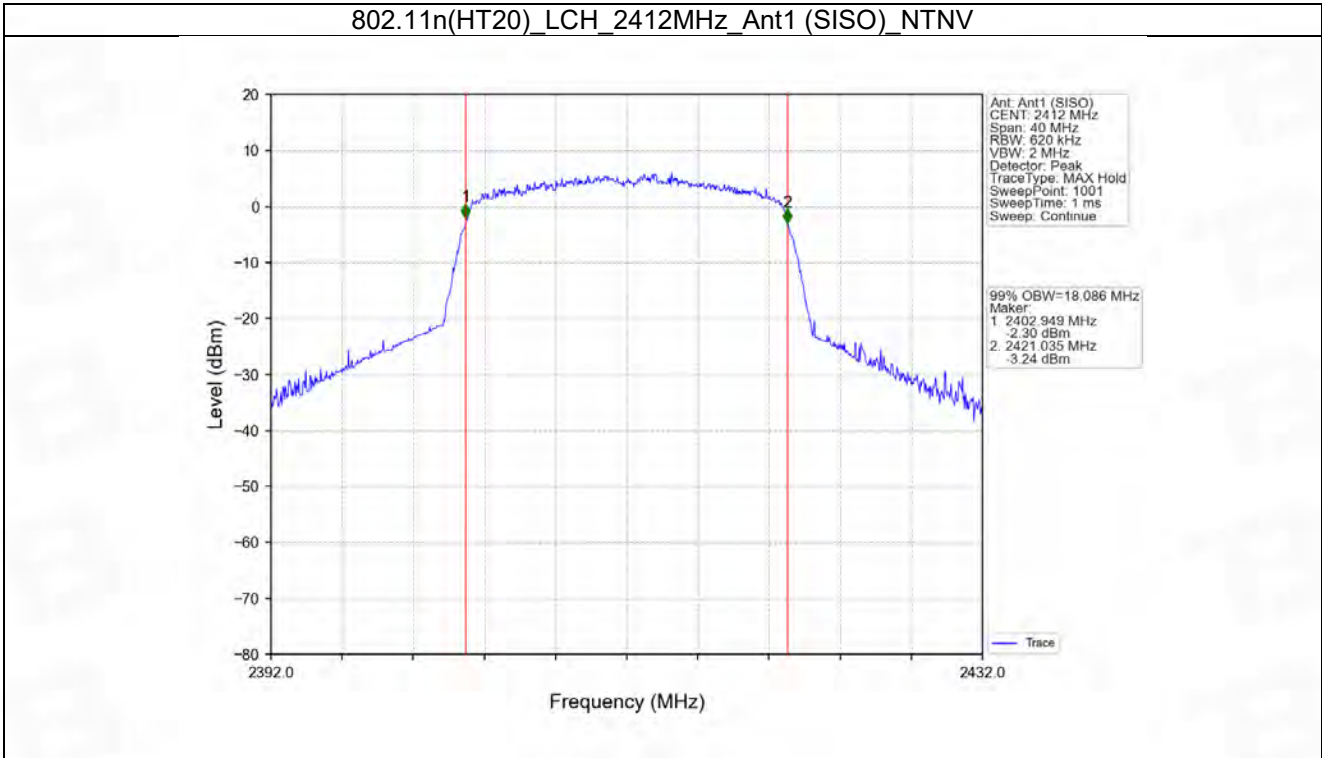

802.11n(HT20)\_HCH\_2462MHz\_Ant1 (SISO)\_NTNV

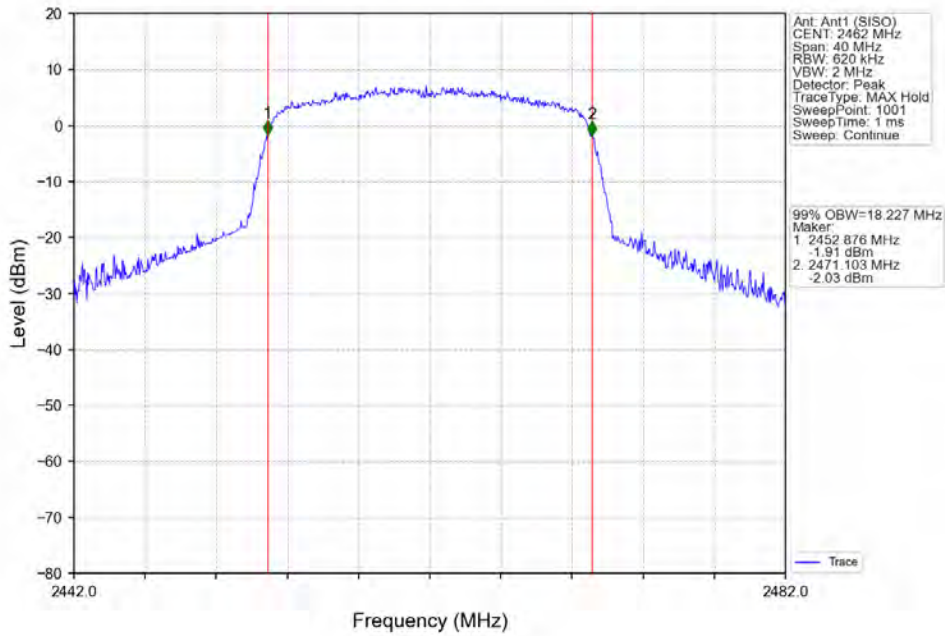

802.11n(HT40)\_LCH\_2422MHz\_Ant1 (SISO)\_NTNV

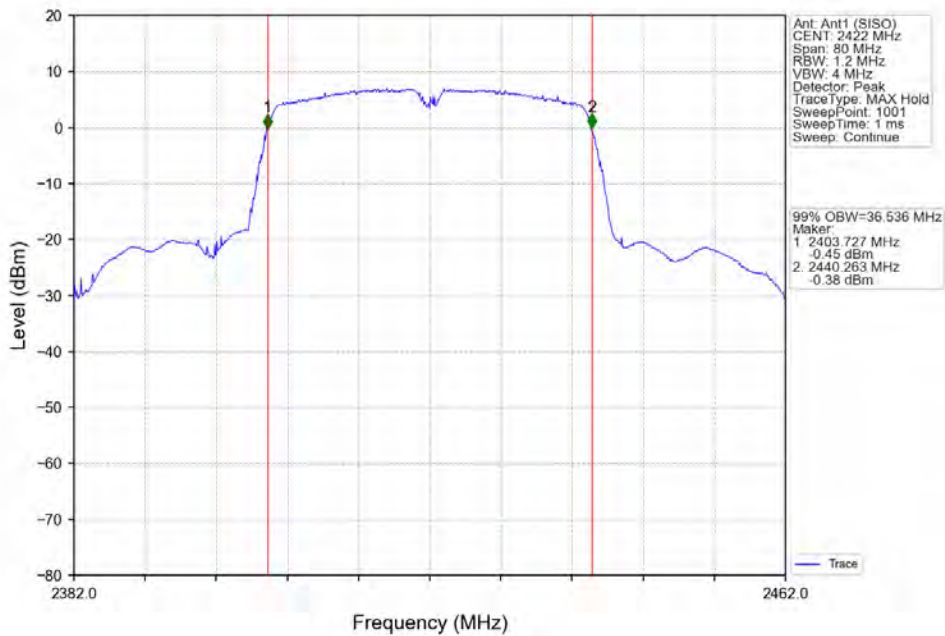

802.11n(HT40)\_MCH\_2437MHz\_Ant1 (SISO)\_NTNV

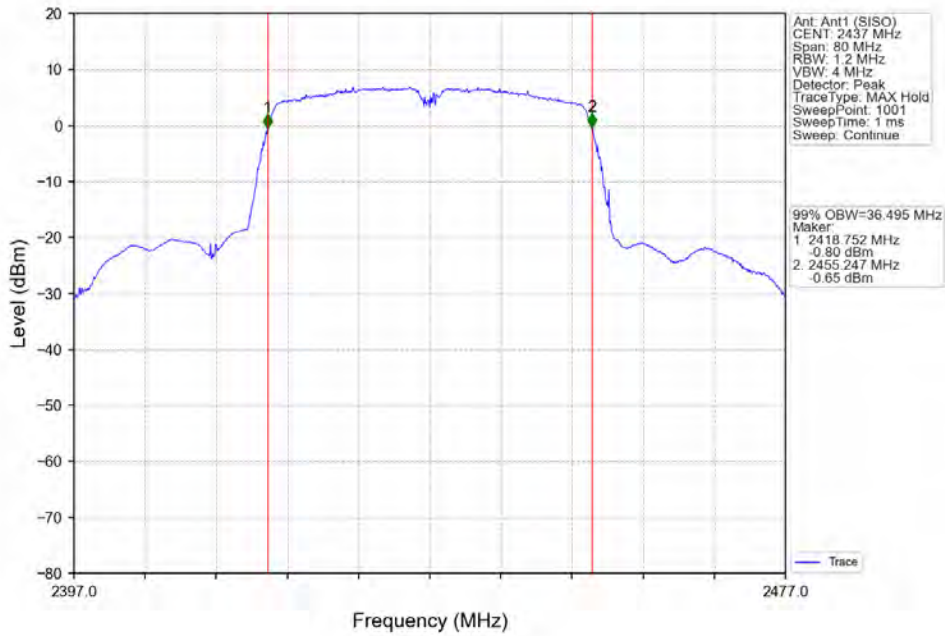

802.11n(HT40)\_HCH\_2452MHz\_Ant1 (SISO)\_NTNV

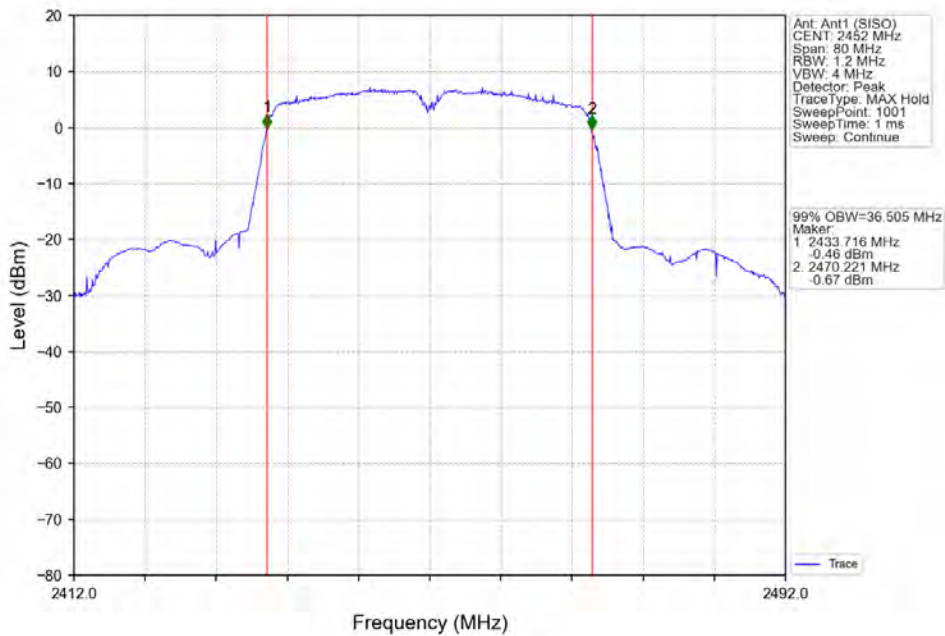

## 2.2 6dB BW

### 2.2.1 Test Result

Mode	TX Type	Frequency (MHz)	ANT	6dB Bandwidth (MHz)		Verdict
				Result	Limit	
802.11b	SISO	2412	1	10.089	$\geq 0.5$	Pass
		2437	1	10.097	$\geq 0.5$	Pass
		2462	1	9.733	$\geq 0.5$	Pass
802.11g	SISO	2412	1	16.410	$\geq 0.5$	Pass
		2437	1	16.383	$\geq 0.5$	Pass
		2462	1	16.498	$\geq 0.5$	Pass
802.11n (HT20)	SISO	2412	1	17.482	$\geq 0.5$	Pass
		2437	1	17.523	$\geq 0.5$	Pass
		2462	1	17.383	$\geq 0.5$	Pass
802.11n (HT40)	SISO	2422	1	36.214	$\geq 0.5$	Pass
		2437	1	35.758	$\geq 0.5$	Pass
		2452	1	36.054	$\geq 0.5$	Pass

### 2.2.2 Test Graph

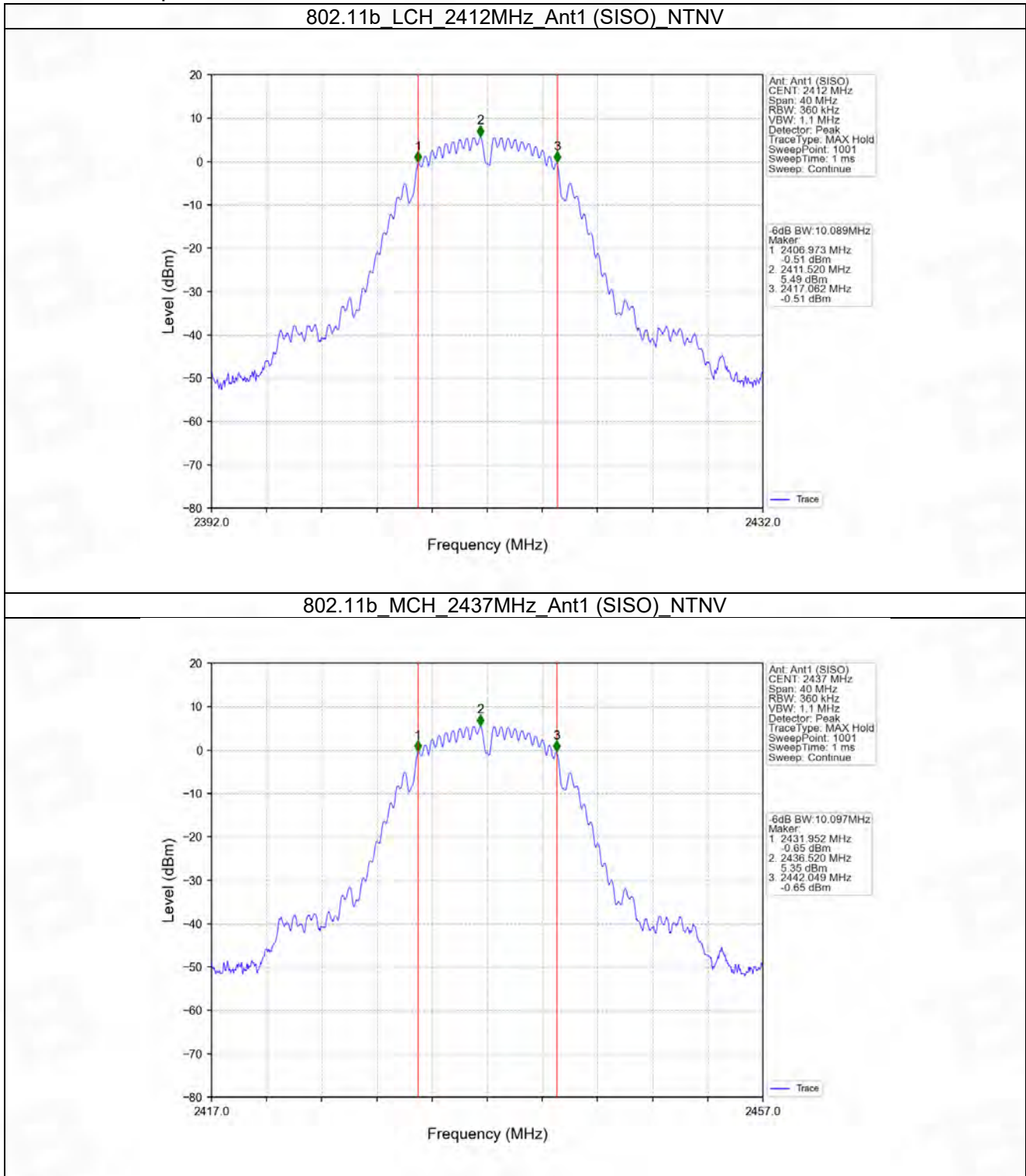

802.11b\_HCH\_2462MHz\_Ant1 (SISO)\_NTNV

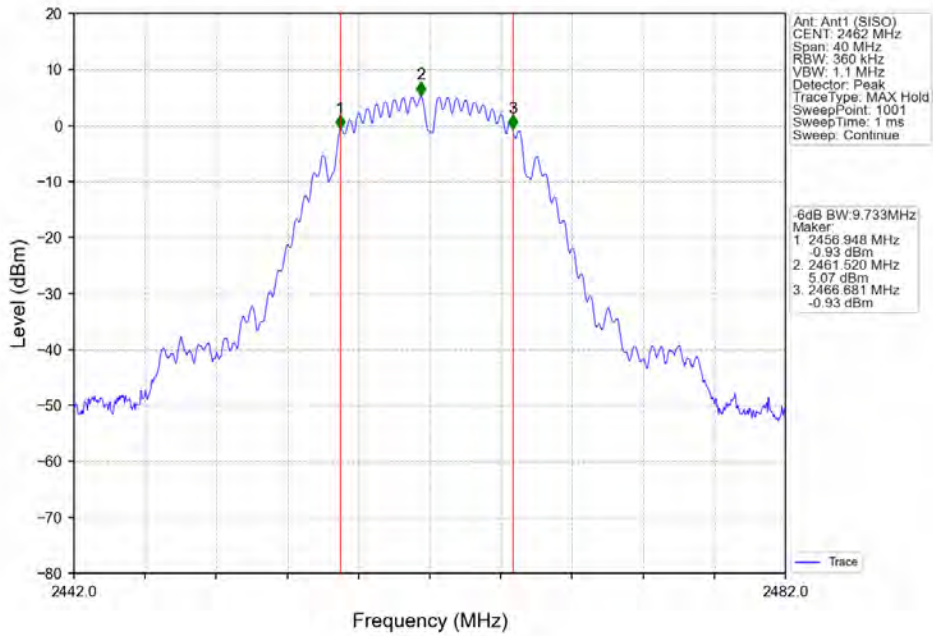

802.11g\_LCH\_2412MHz\_Ant1 (SISO)\_NTNV

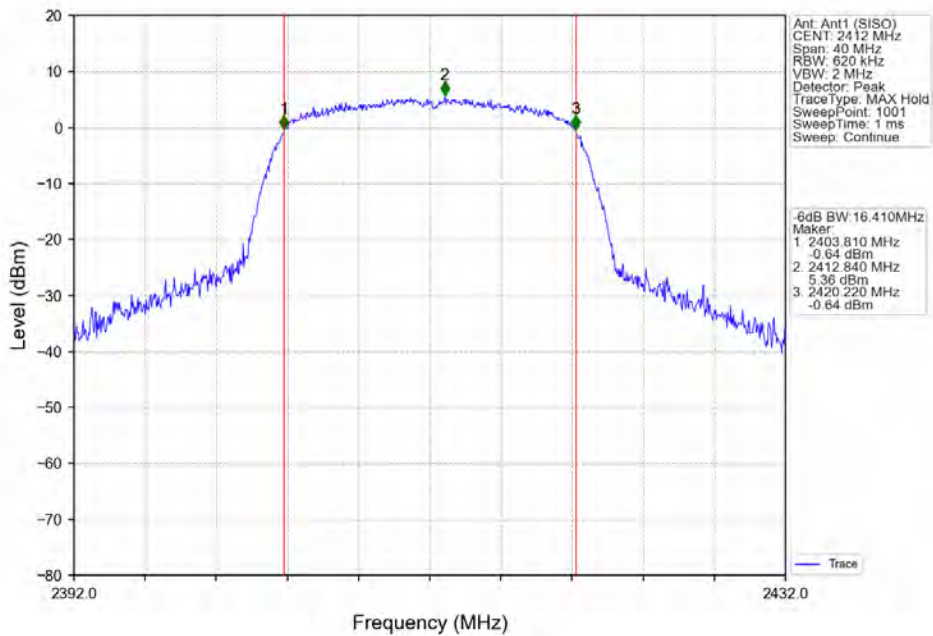

802.11g\_MCH\_2437MHz\_Ant1 (SISO)\_NTNV

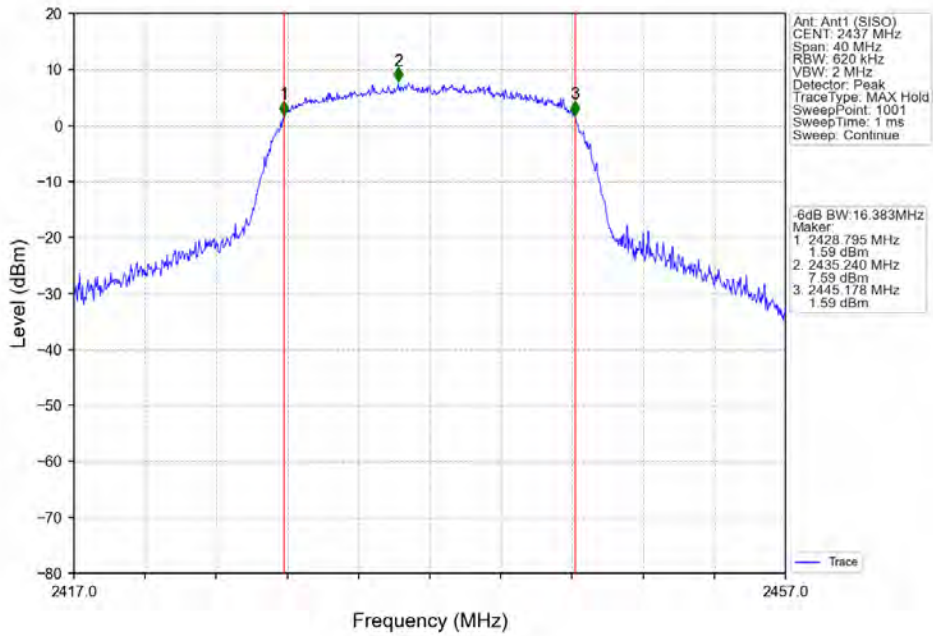

802.11g\_HCH\_2462MHz\_Ant1 (SISO)\_NTNV

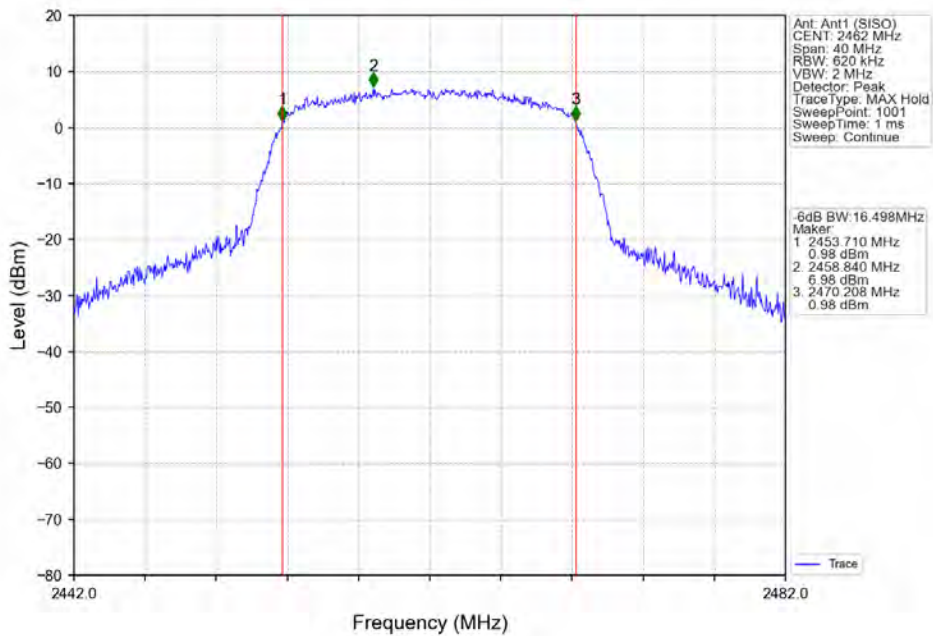



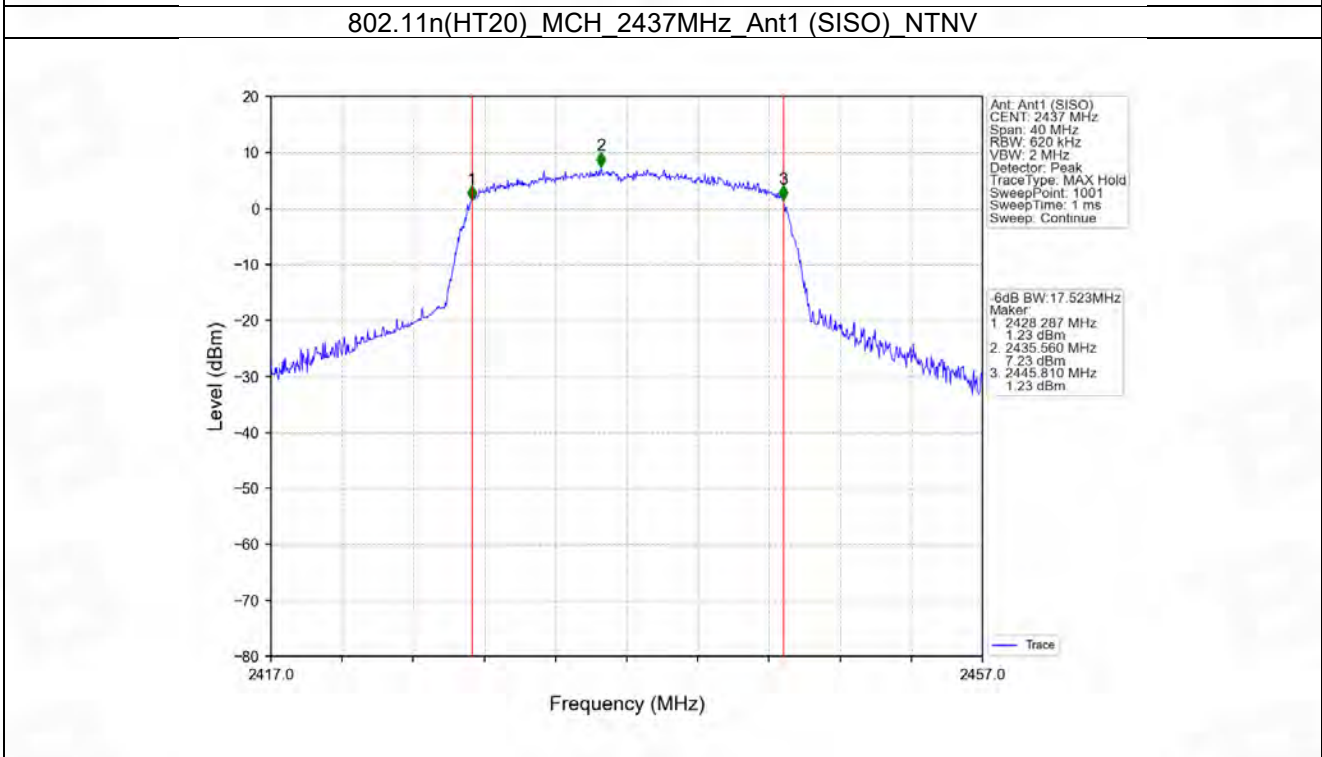
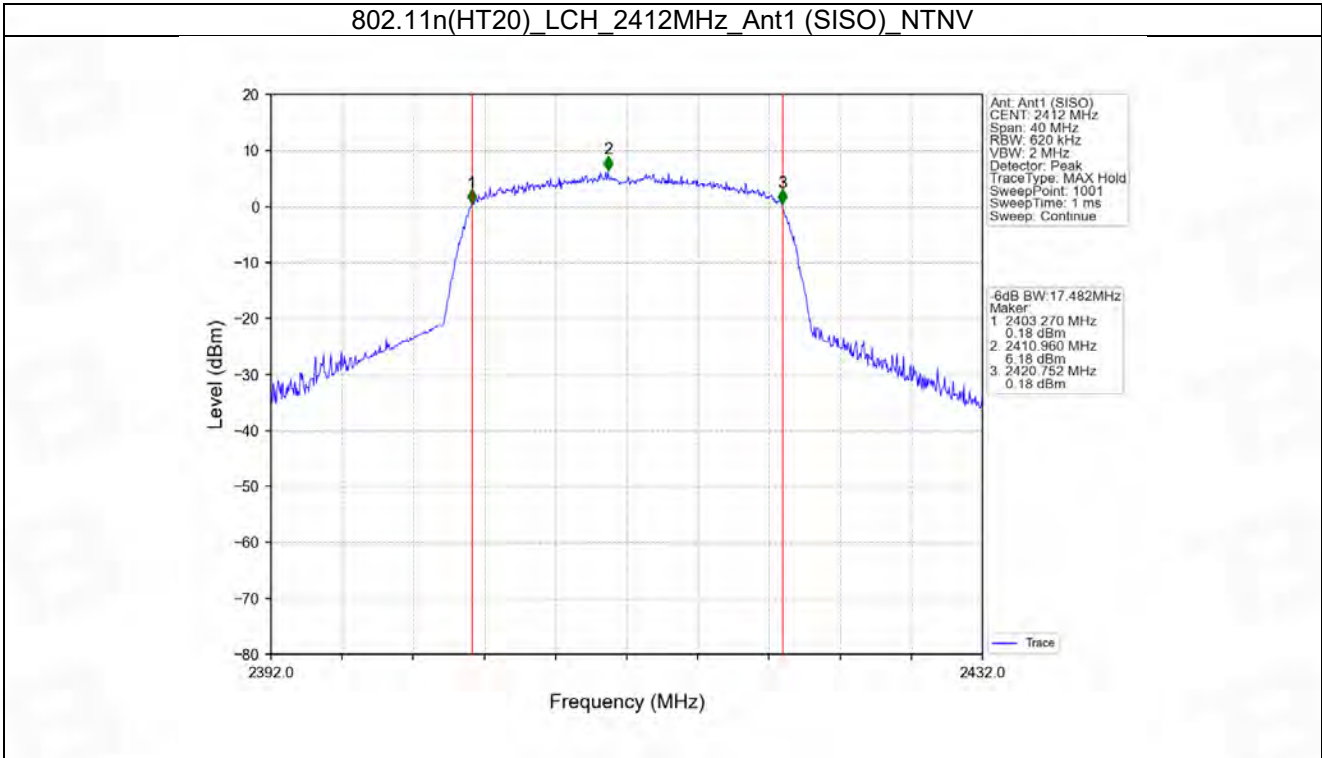

802.11n(HT20)\_HCH\_2462MHz\_Ant1 (SISO)\_NTNV

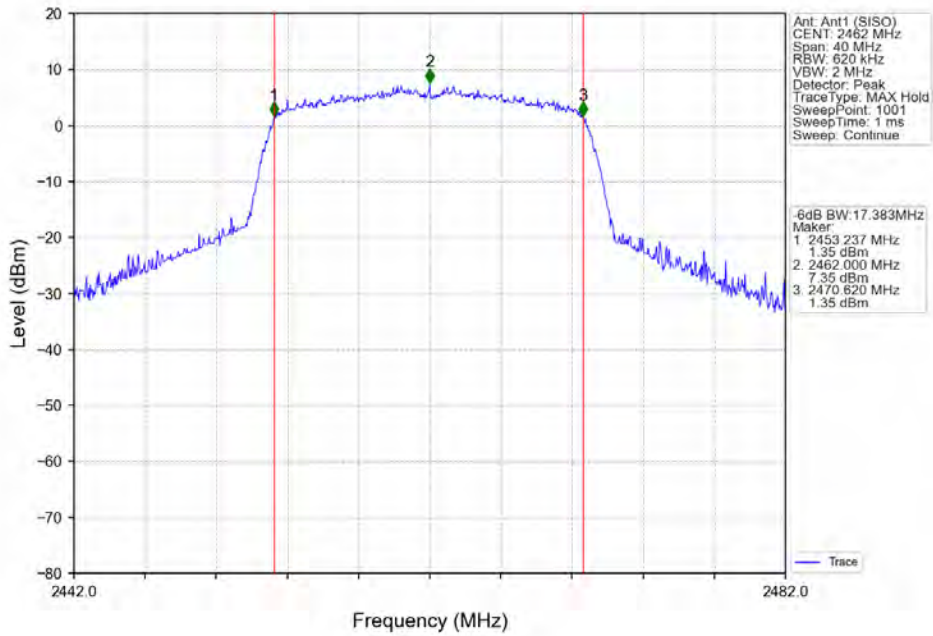

802.11n(HT40)\_LCH\_2422MHz\_Ant1 (SISO)\_NTNV

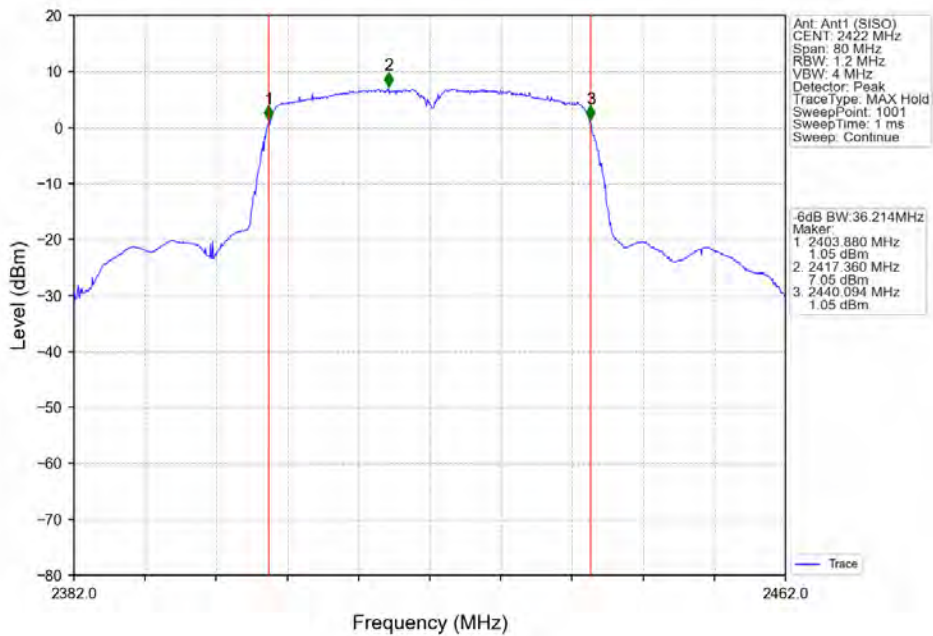

802.11n(HT40)\_MCH\_2437MHz\_Ant1 (SISO)\_NTNV

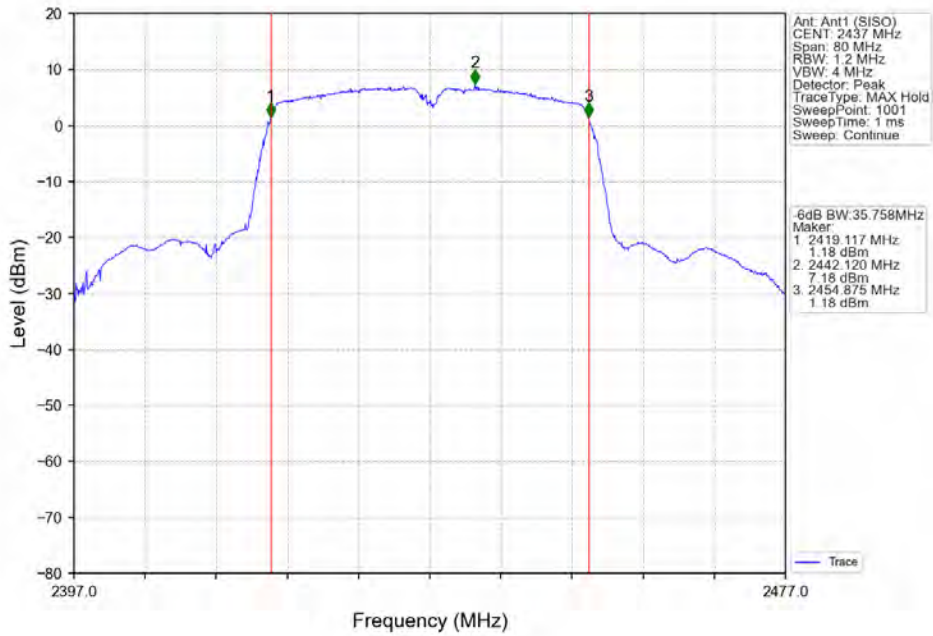

802.11n(HT40)\_HCH\_2452MHz\_Ant1 (SISO)\_NTNV

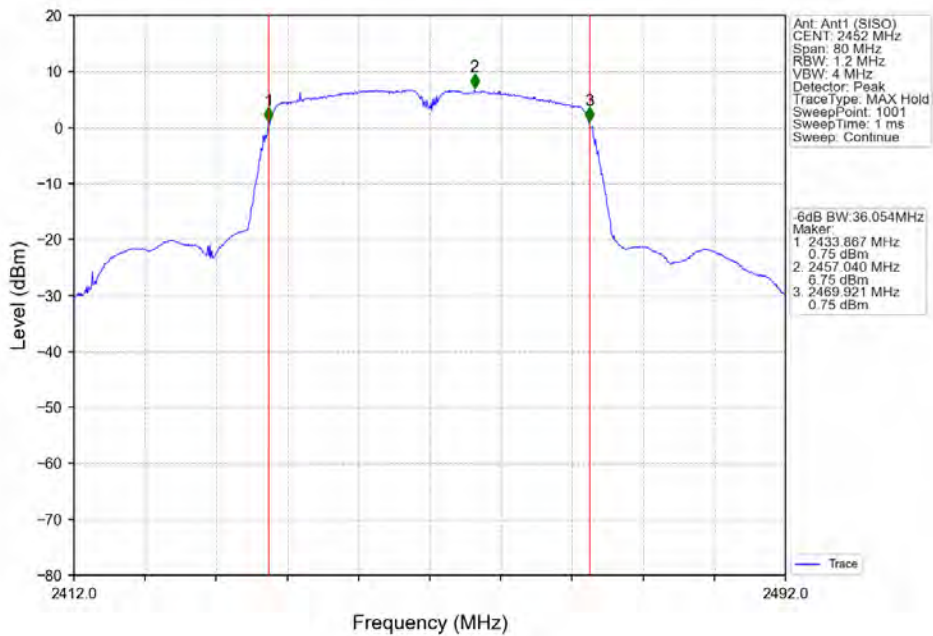

### 3. Maximum Conducted Output Power

#### 3.1 Power

##### 3.1.1 Test Result

Mode	TX Type	Frequency (MHz)	Maximum Peak Conducted Output Power (dBm)		Verdict
			ANT1	Limit	
802.11b	SISO	2412	16.84	<=30	Pass
		2437	16.53	<=30	Pass
		2462	16.21	<=30	Pass
802.11g	SISO	2412	17.76	<=30	Pass
		2437	19.54	<=30	Pass
		2462	19.35	<=30	Pass
802.11n (HT20)	SISO	2412	18.20	<=30	Pass
		2437	19.57	<=30	Pass
		2462	19.31	<=30	Pass
802.11n (HT40)	SISO	2422	19.56	<=30	Pass
		2437	19.34	<=30	Pass
		2452	19.32	<=30	Pass

Note1: Antenna Gain: Ant1: 1.11dBi;

### 3.1.2 Test Graph

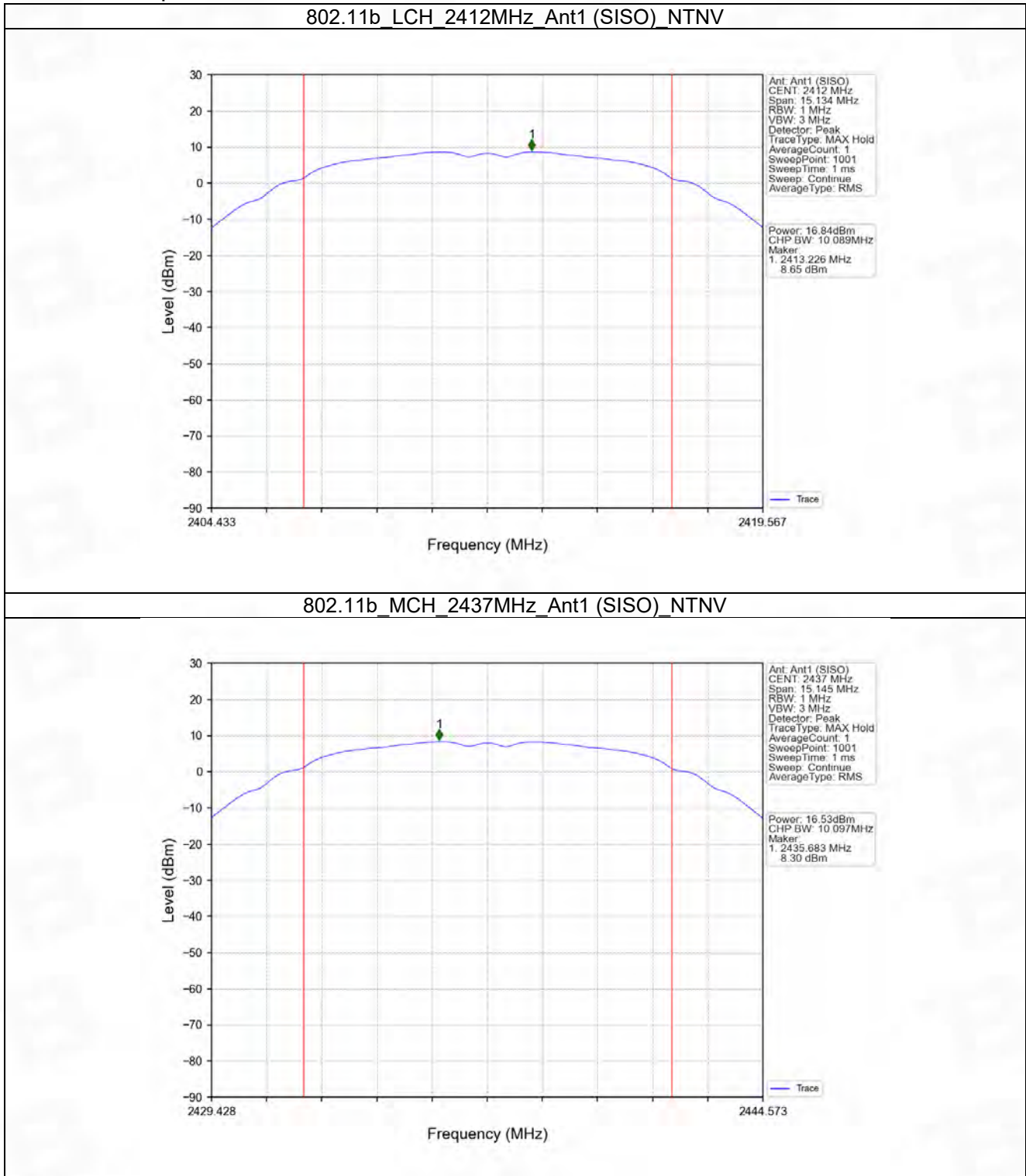

802.11b\_HCH\_2462MHz\_Ant1 (SISO)\_NTNV

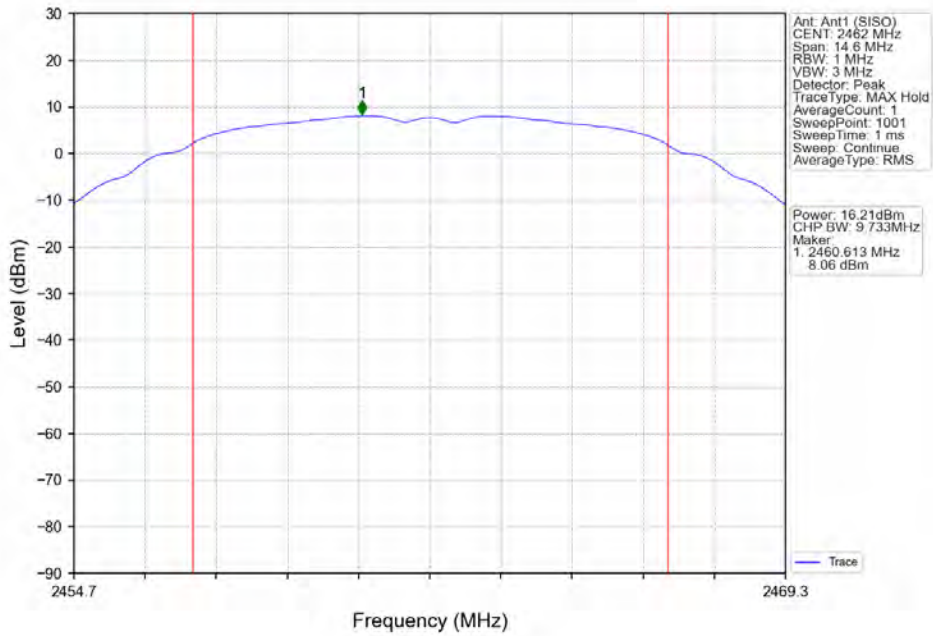

802.11g\_LCH\_2412MHz\_Ant1 (SISO)\_NTNV

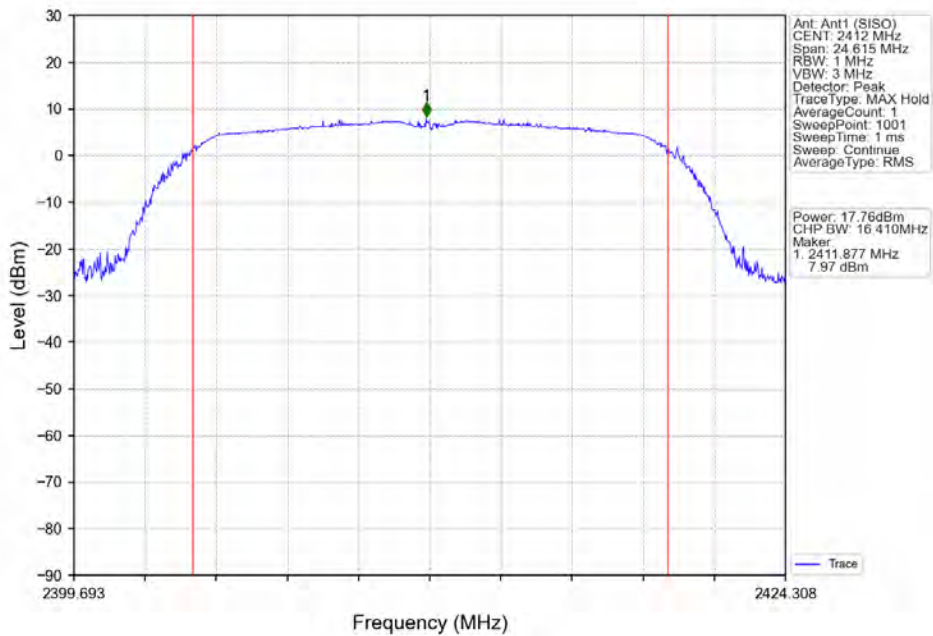

802.11g\_MCH\_2437MHz\_Ant1 (SISO)\_NTNV

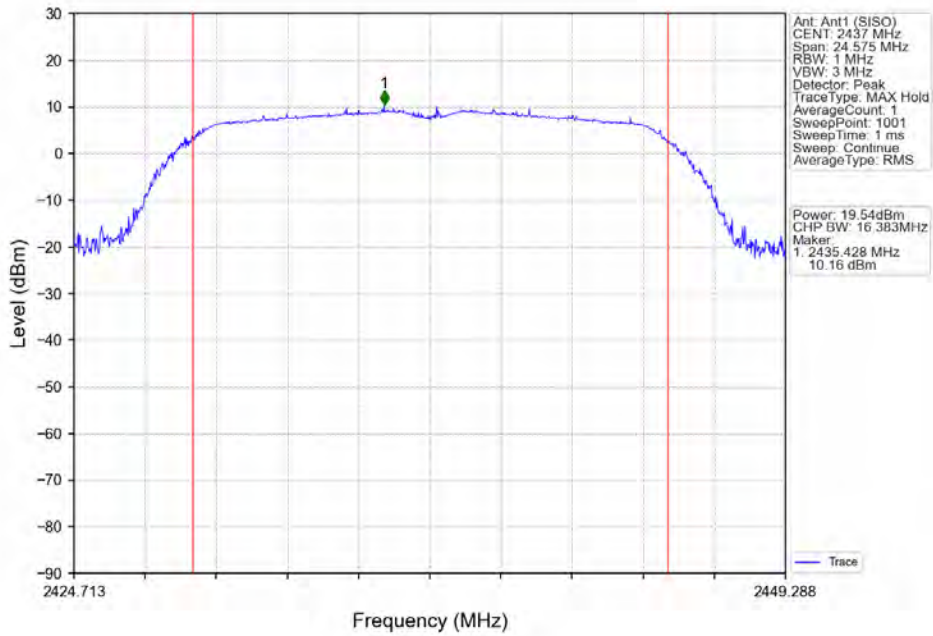

802.11g\_HCH\_2462MHz\_Ant1 (SISO)\_NTNV

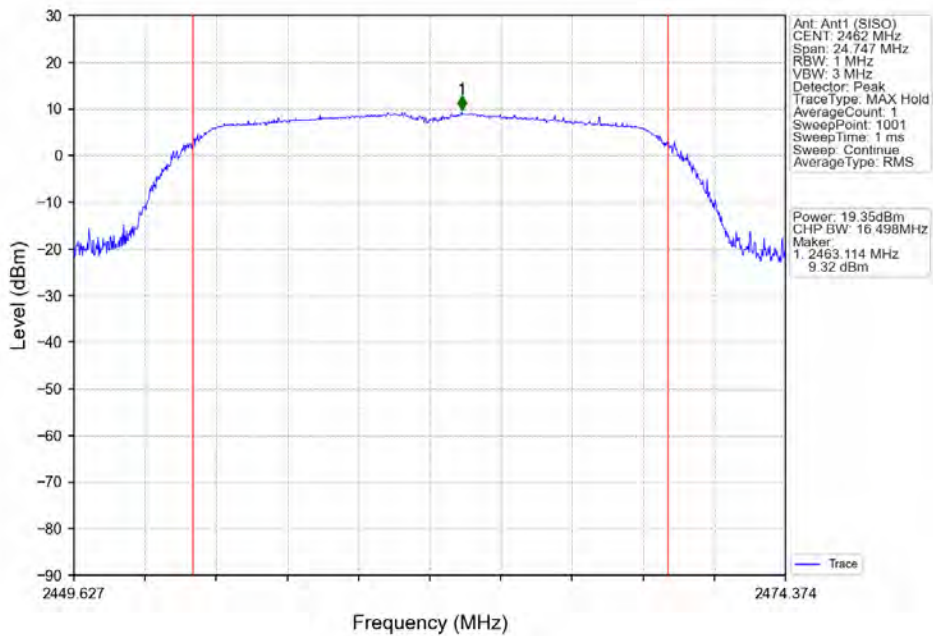

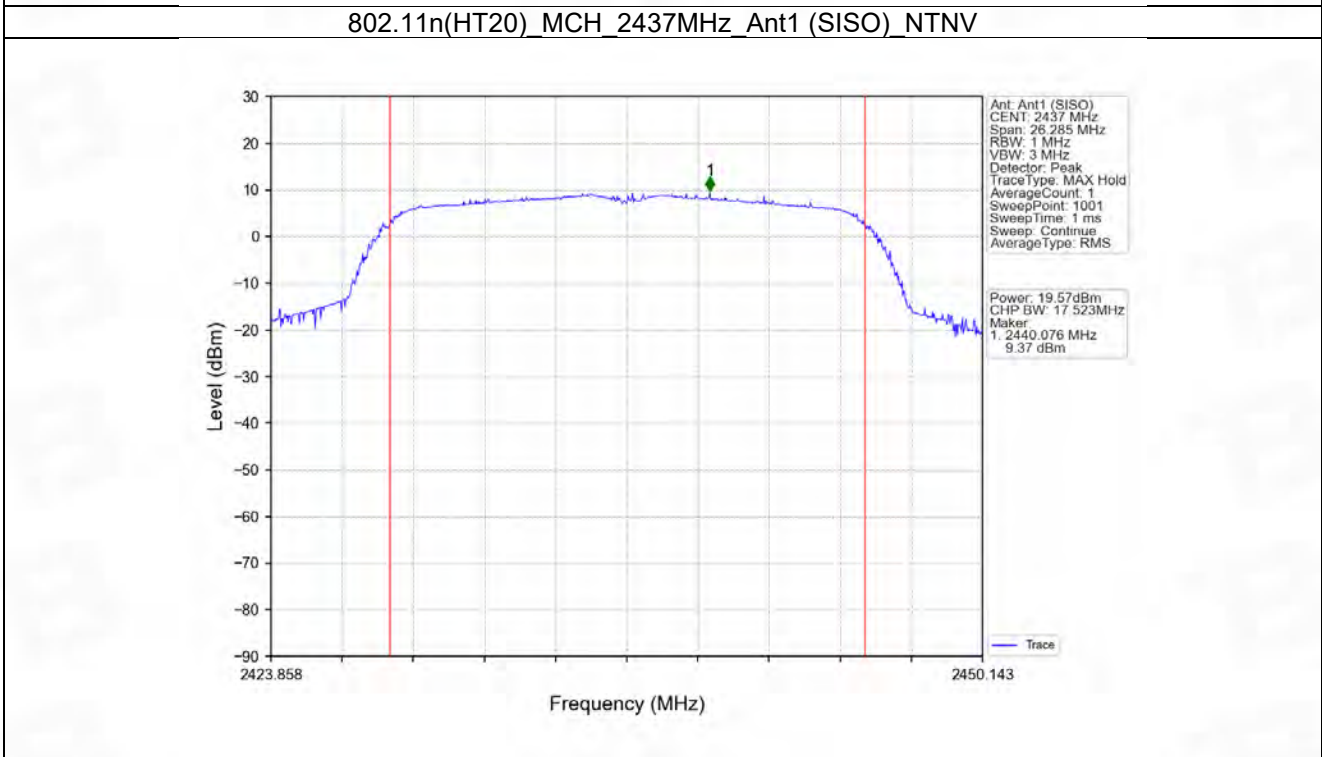
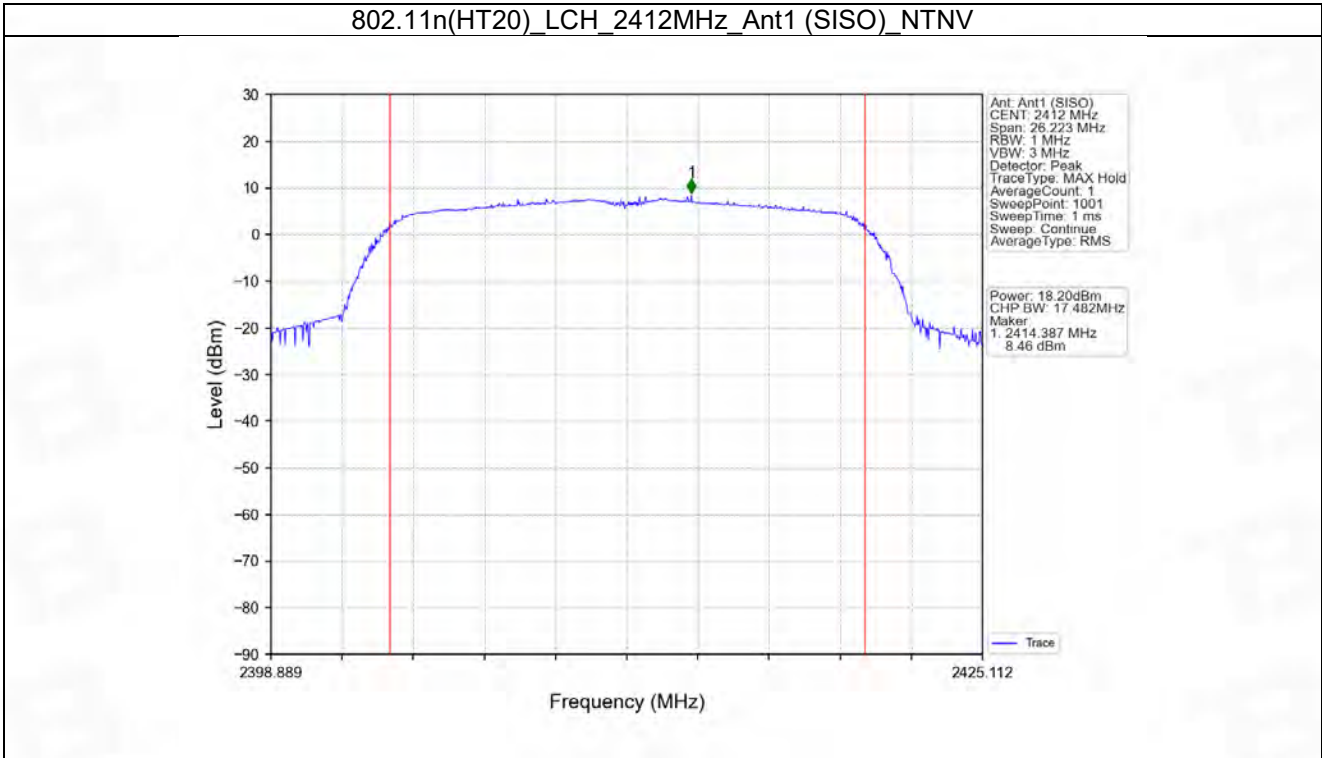



802.11n(HT20)\_HCH\_2462MHz\_Ant1 (SISO)\_NTNV

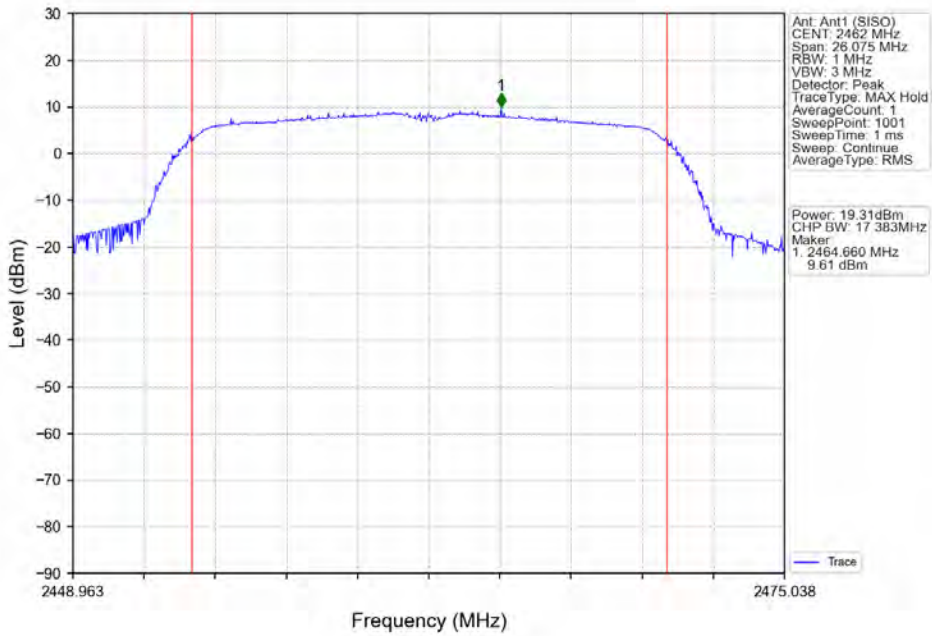

802.11n(HT40)\_LCH\_2422MHz\_Ant1 (SISO)\_NTNV

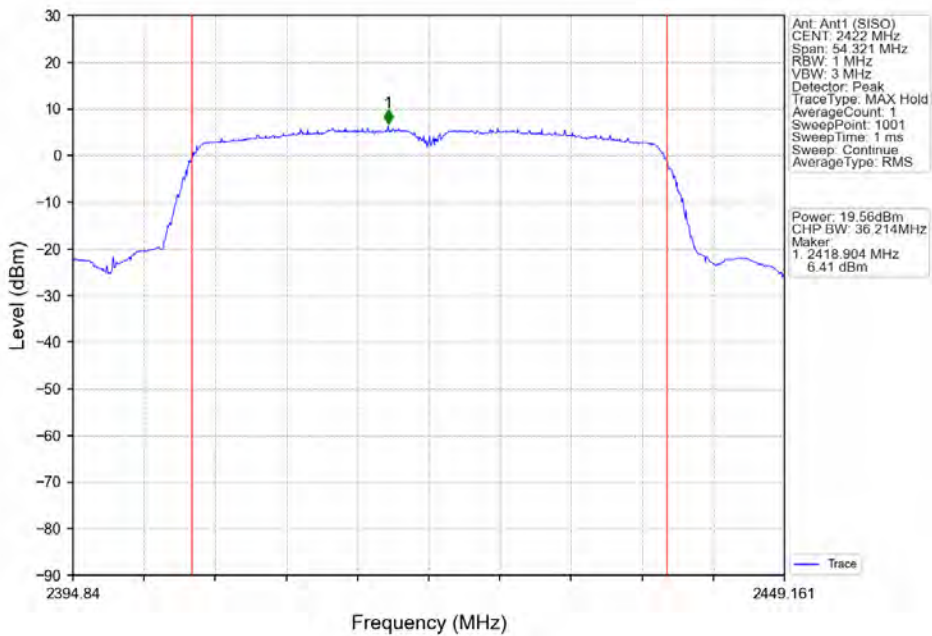

802.11n(HT40)\_MCH\_2437MHz\_Ant1 (SISO)\_NTNV

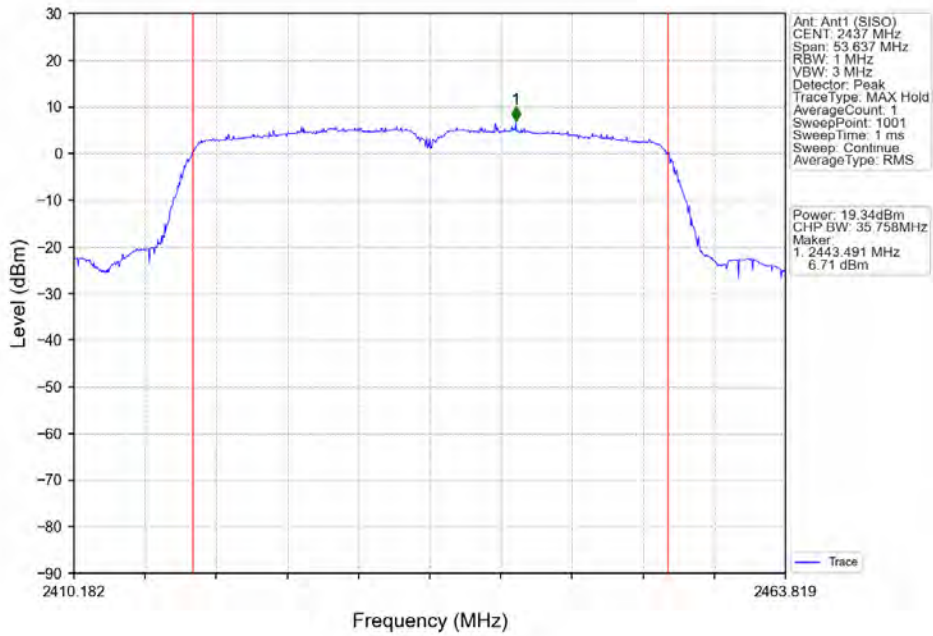

802.11n(HT40)\_HCH\_2452MHz\_Ant1 (SISO)\_NTNV

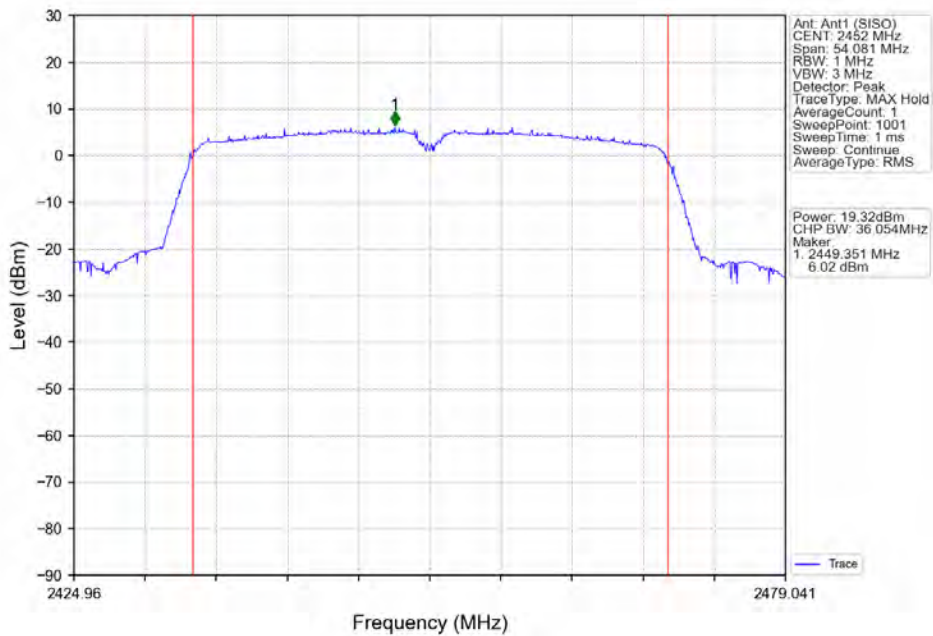

## 4. Maximum Power Spectral Density

### 4.1 PSD

#### 4.1.1 Test Result

Mode	TX Type	Frequency (MHz)	Maximum PSD (dBm/3kHz)		Verdict
			ANT1	Limit	
802.11b	SISO	2412	-9.24	<=8	Pass
		2437	-8.96	<=8	Pass
		2462	-8.89	<=8	Pass
802.11g	SISO	2412	-15.26	<=8	Pass
		2437	-12.44	<=8	Pass
		2462	-13.41	<=8	Pass
802.11n (HT20)	SISO	2412	-12.79	<=8	Pass
		2437	-13.00	<=8	Pass
		2462	-12.92	<=8	Pass
802.11n (HT40)	SISO	2422	-16.94	<=8	Pass
		2437	-15.98	<=8	Pass
		2452	-16.05	<=8	Pass

Note1: Antenna Gain: Ant1: 1.11dBi;

### 4.1.2 Test Graph

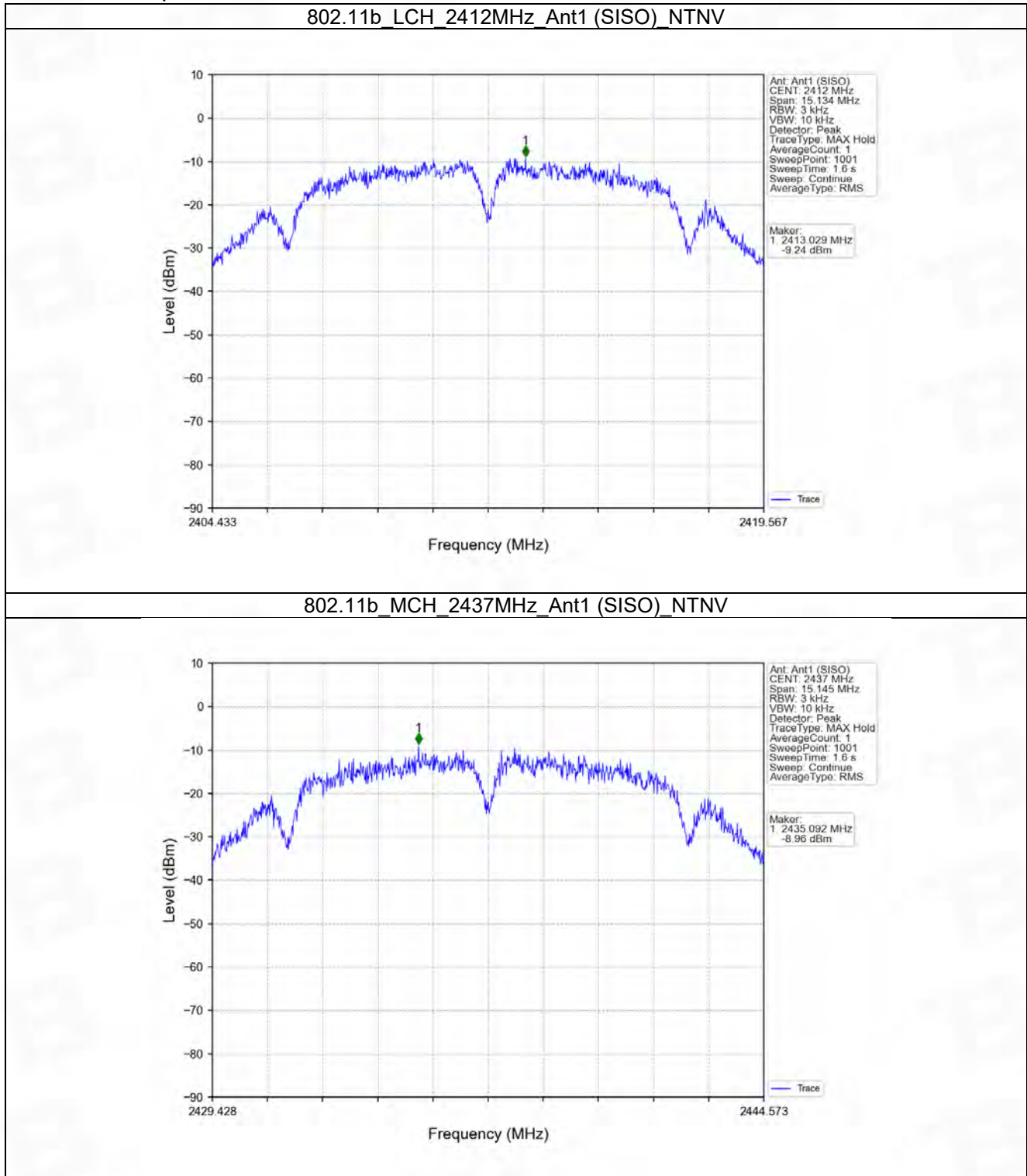

802.11b\_HCH\_2462MHz\_Ant1 (SISO)\_NTNV

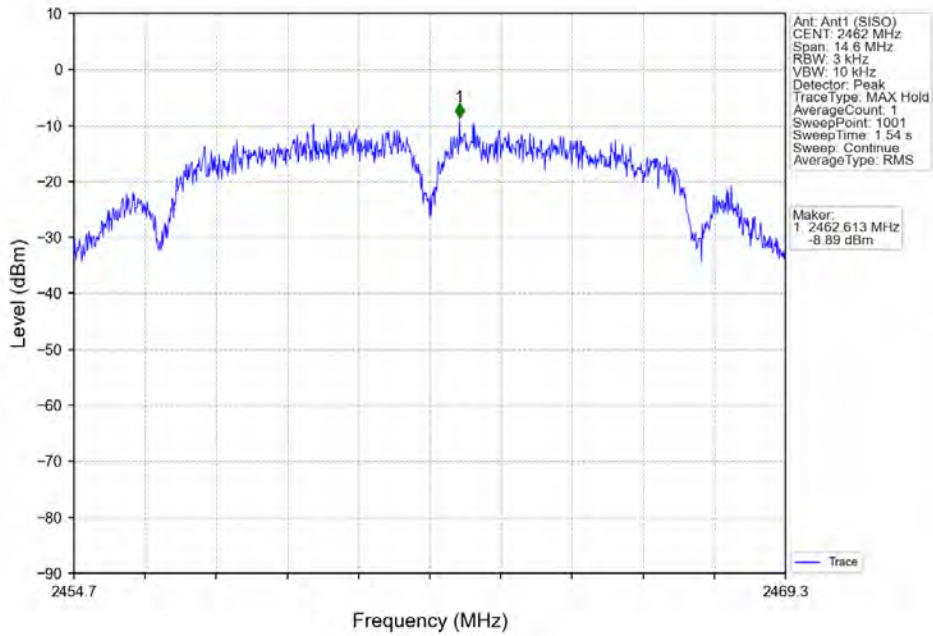

802.11g\_LCH\_2412MHz\_Ant1 (SISO)\_NTNV

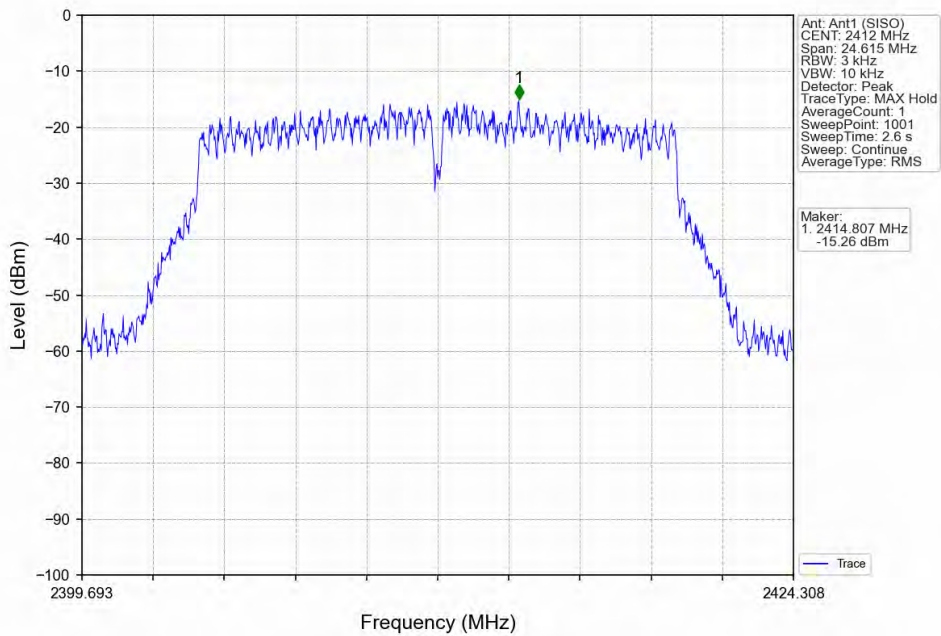

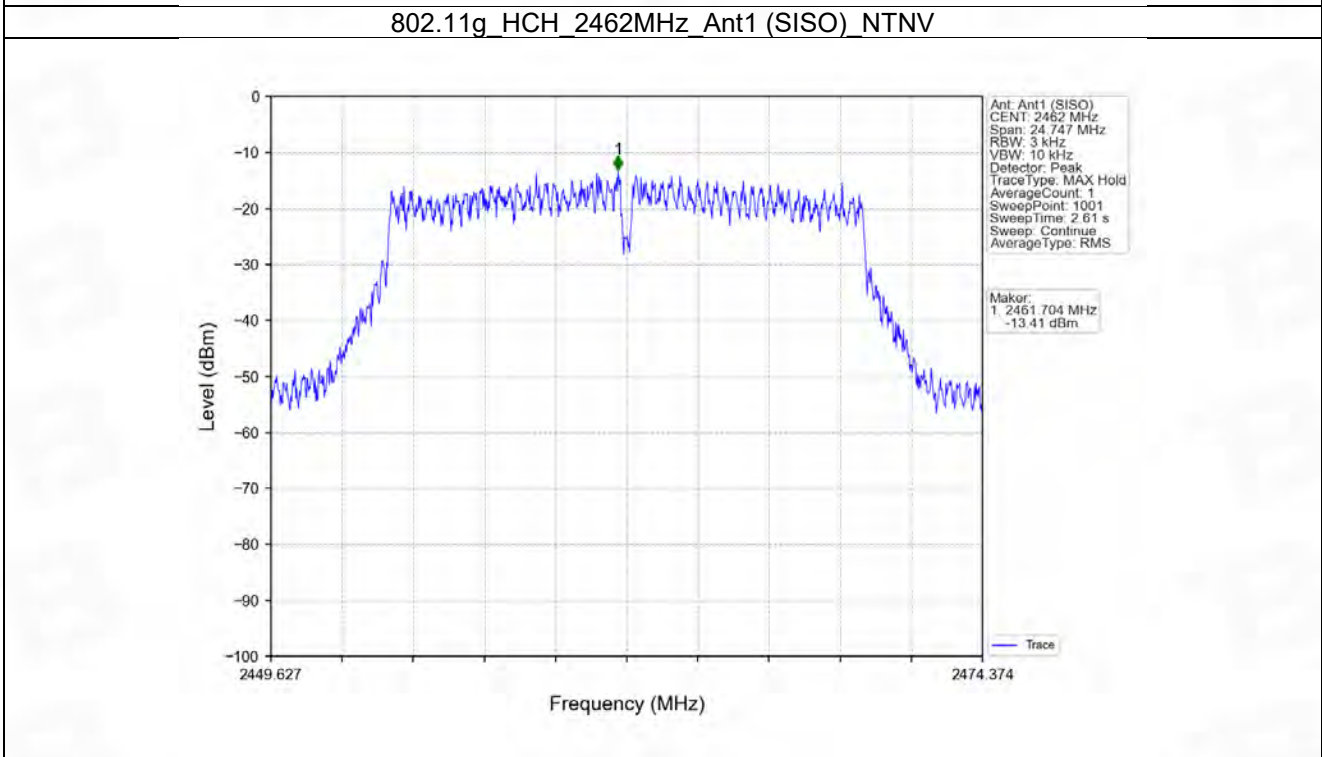
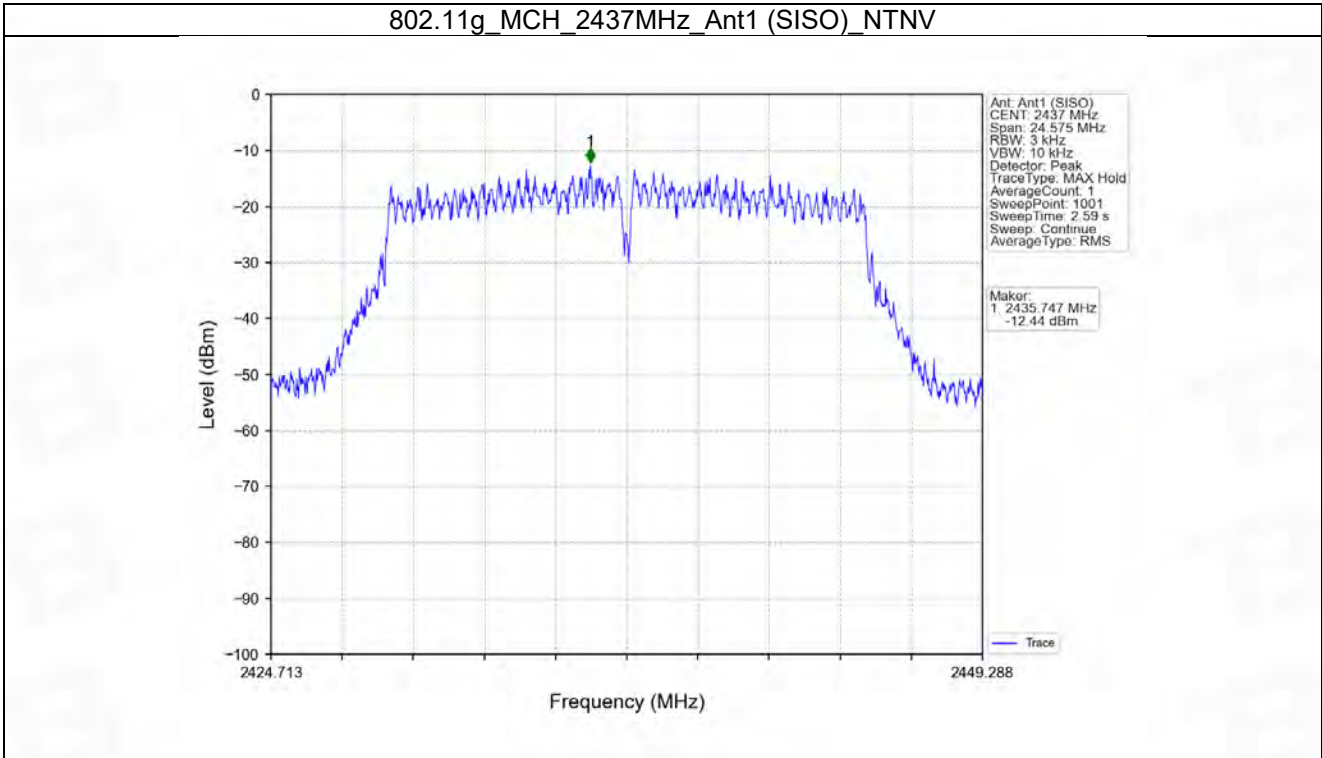

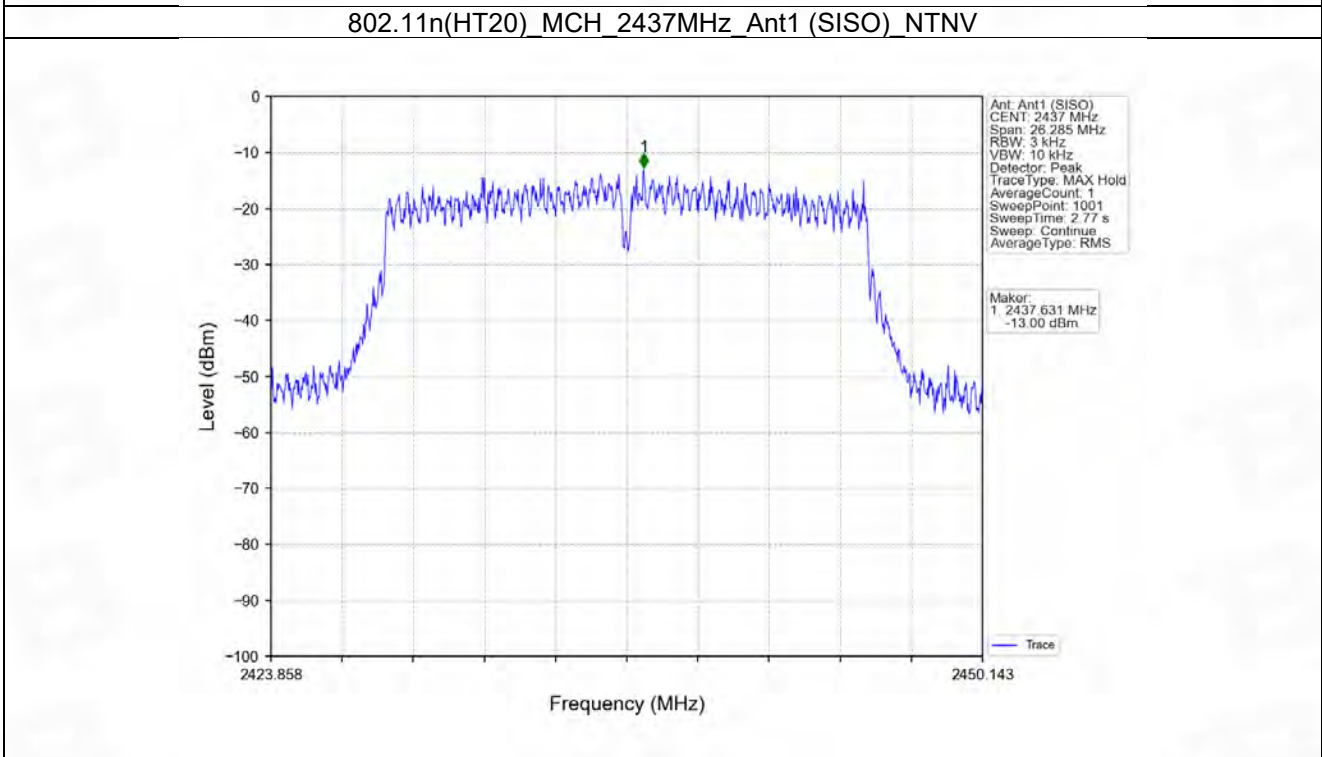
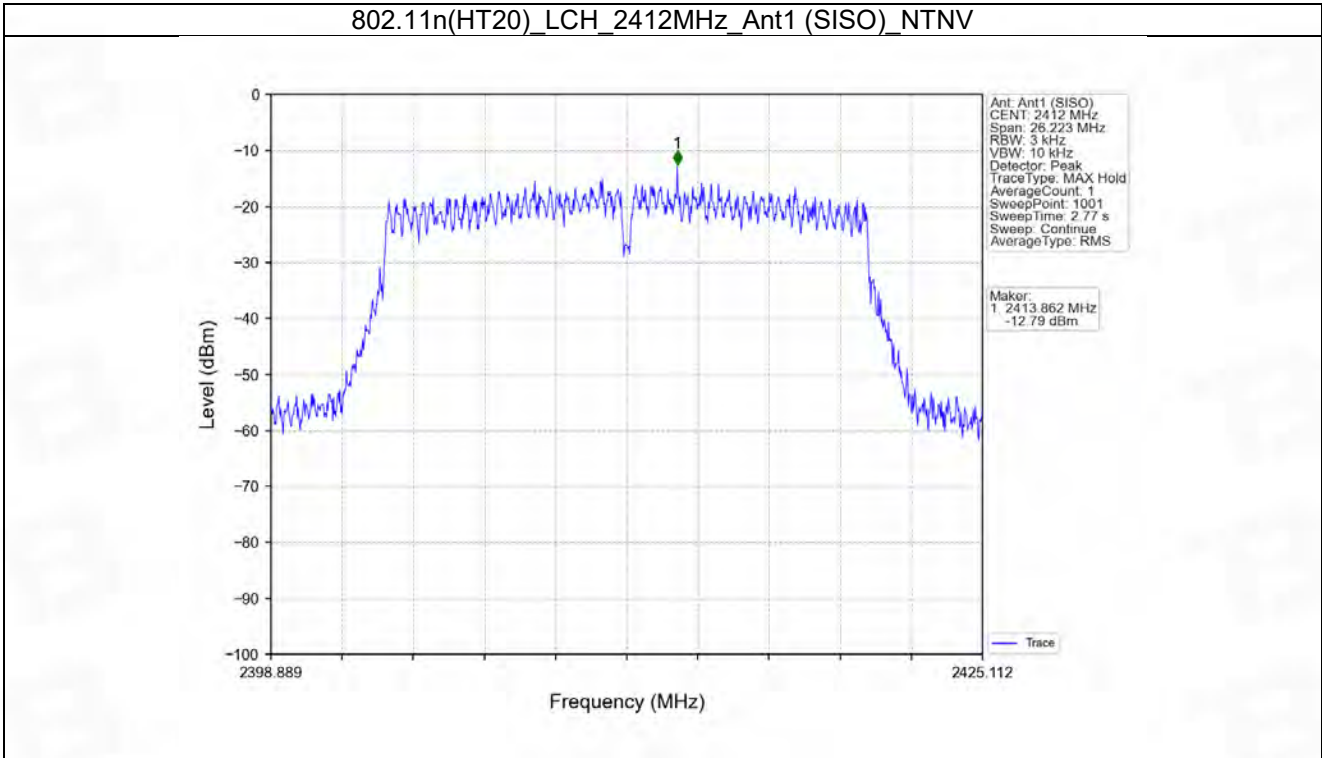

802.11n(HT20)\_HCH\_2462MHz\_Ant1 (SISO)\_NTNV

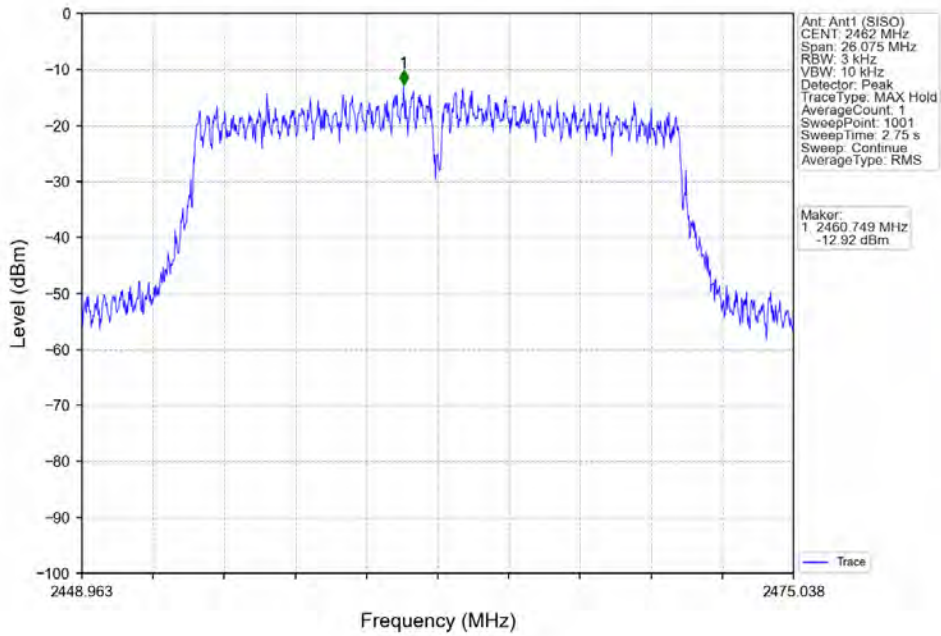

802.11n(HT40)\_LCH\_2422MHz\_Ant1 (SISO)\_NTNV

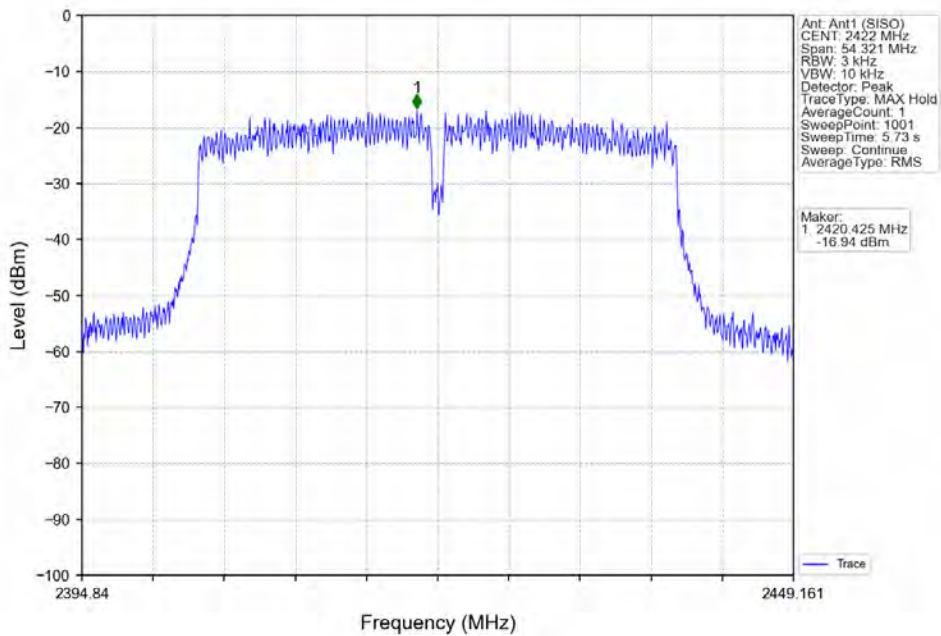



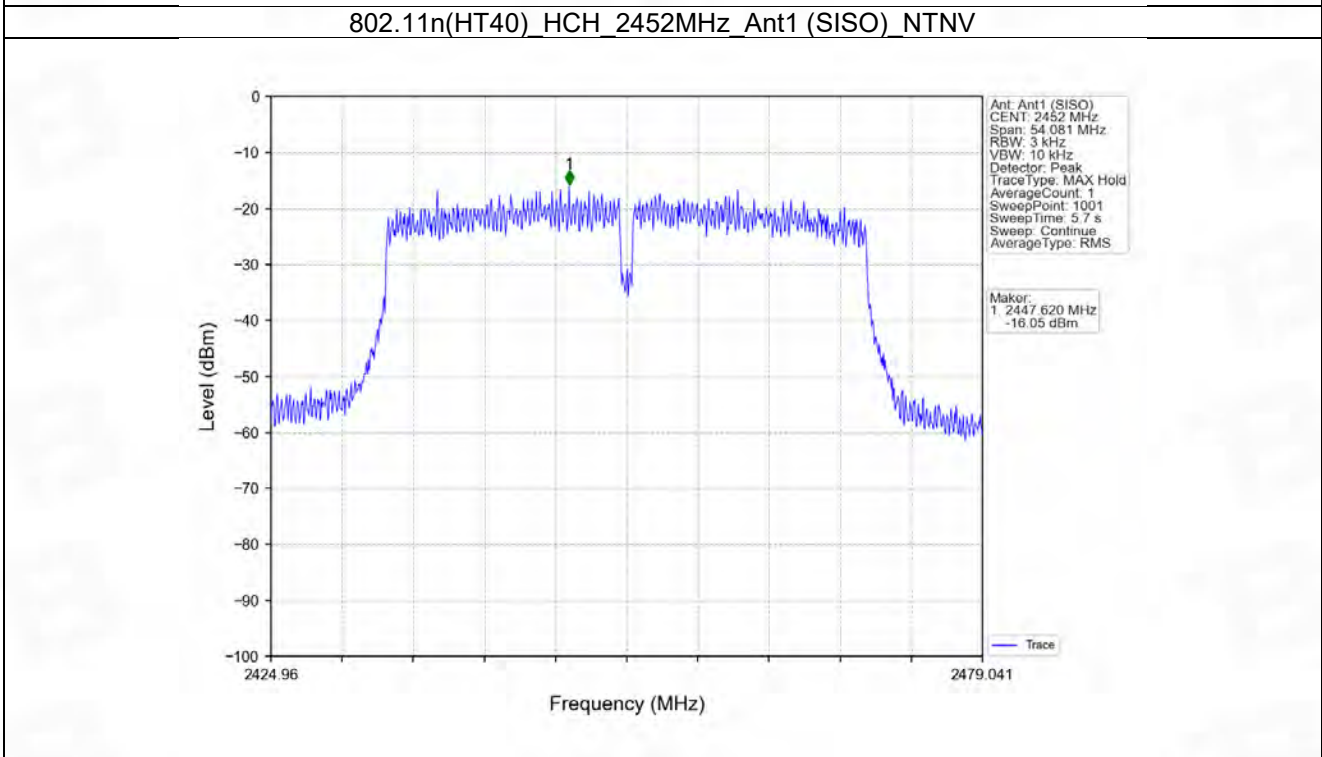
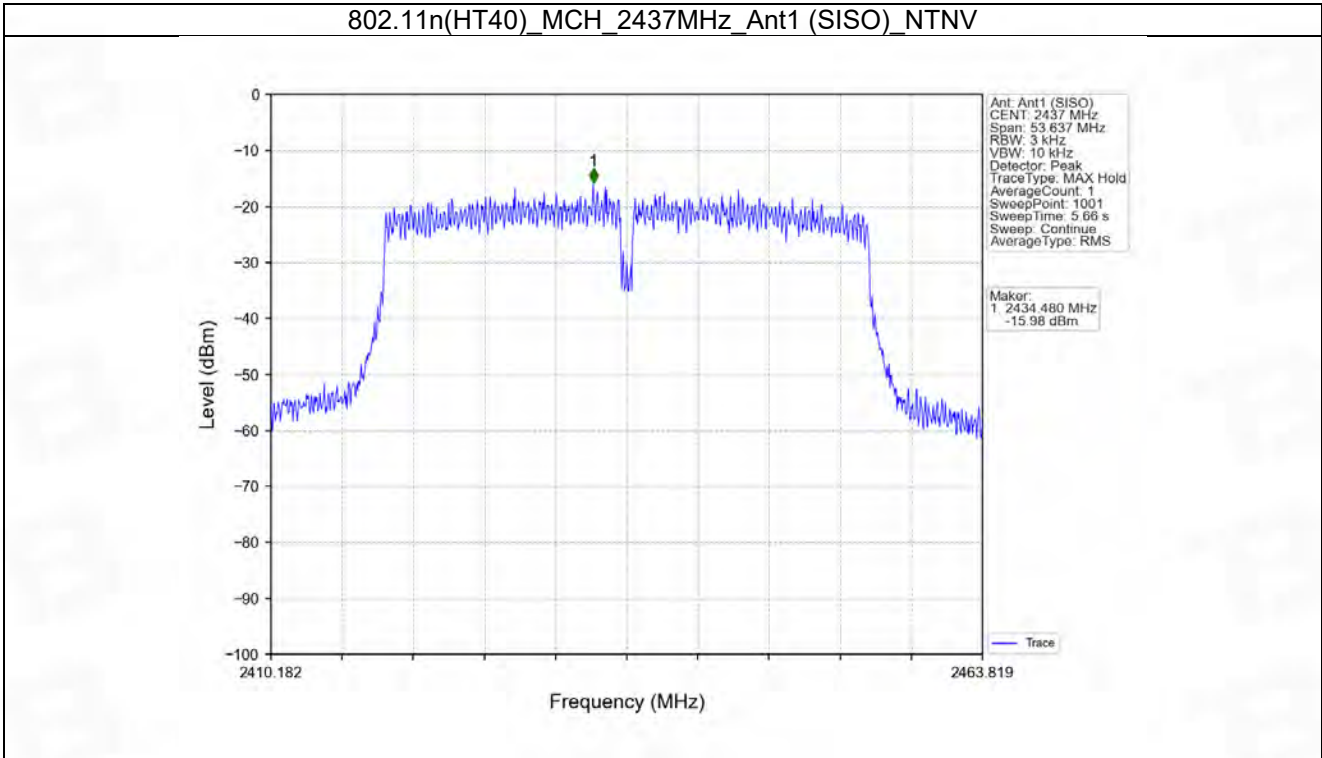

## 5. Unwanted Emissions In Non-restricted Frequency Bands

### 5.1 Ref

#### 5.1.1 Test Result

Mode	TX Type	Frequency (MHz)	ANT	Level of Reference (dBm)
802.11b	SISO	2412	1	5.44
		2437	1	5.27
		2462	1	4.90
802.11g	SISO	2412	1	0.18
		2437	1	1.93
		2462	1	1.83
802.11n (HT20)	SISO	2412	1	0.55
		2437	1	1.99
		2462	1	1.72
802.11n (HT40)	SISO	2422	1	-2.12
		2437	1	-2.07
		2452	1	-2.09

Note1: Refer to FCC Part 15.247 (d) and ANSI C63.10-2013, the channel contains the maximum PSD level was used to establish the reference level.

### 5.1.2 Test Graph

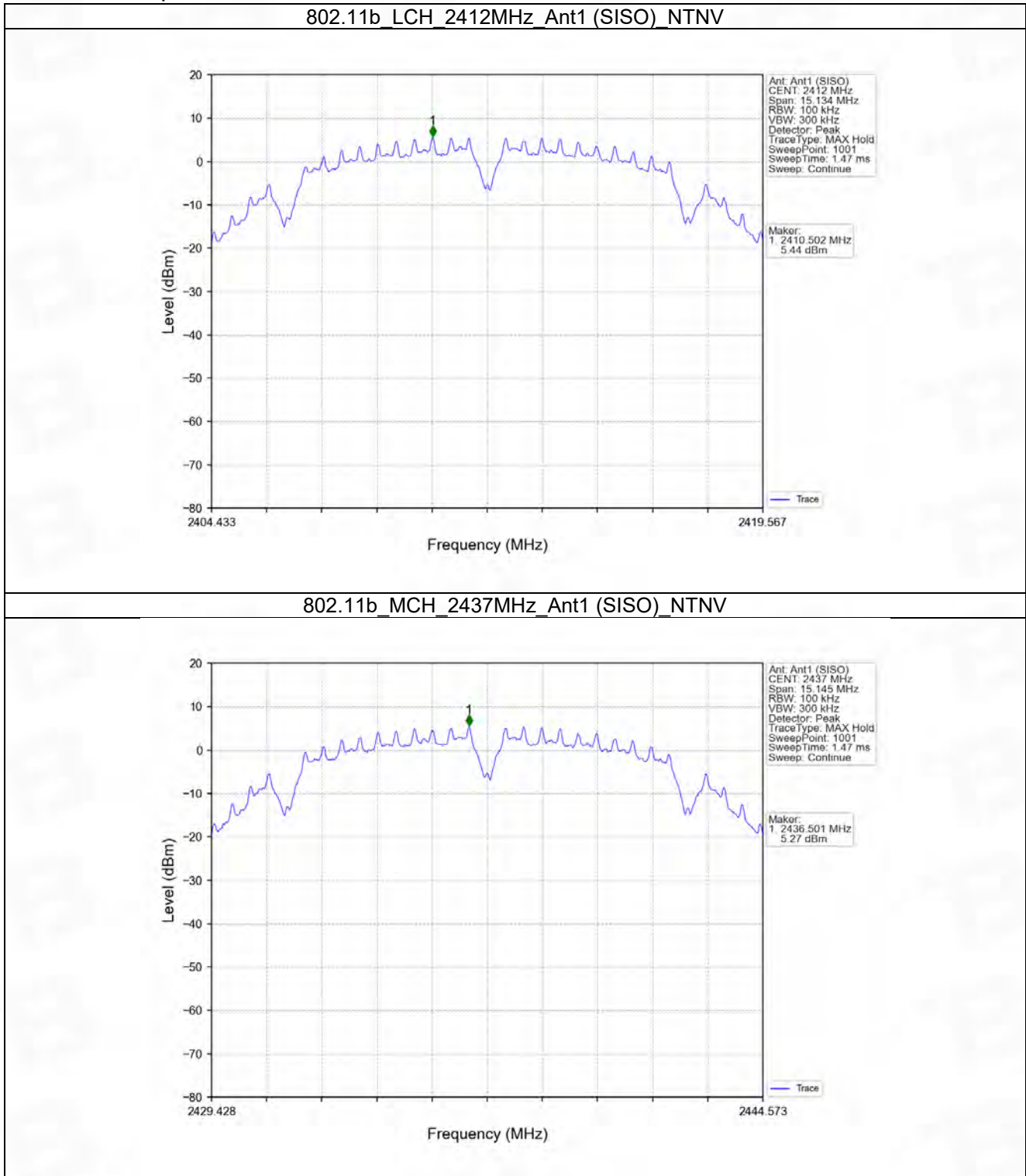

802.11b\_HCH\_2462MHz\_Ant1 (SISO)\_NTNV

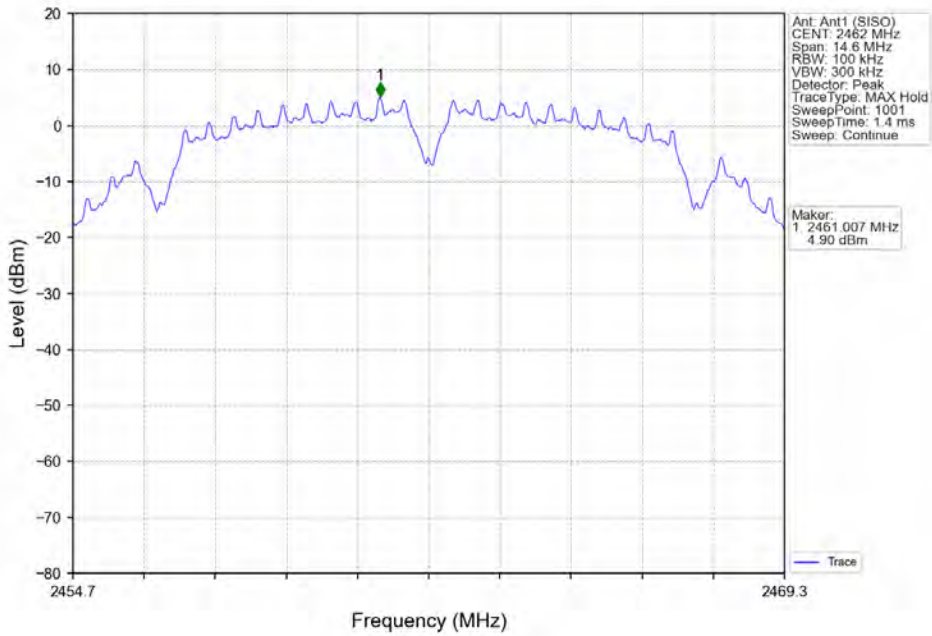

802.11g\_LCH\_2412MHz\_Ant1 (SISO)\_NTNV

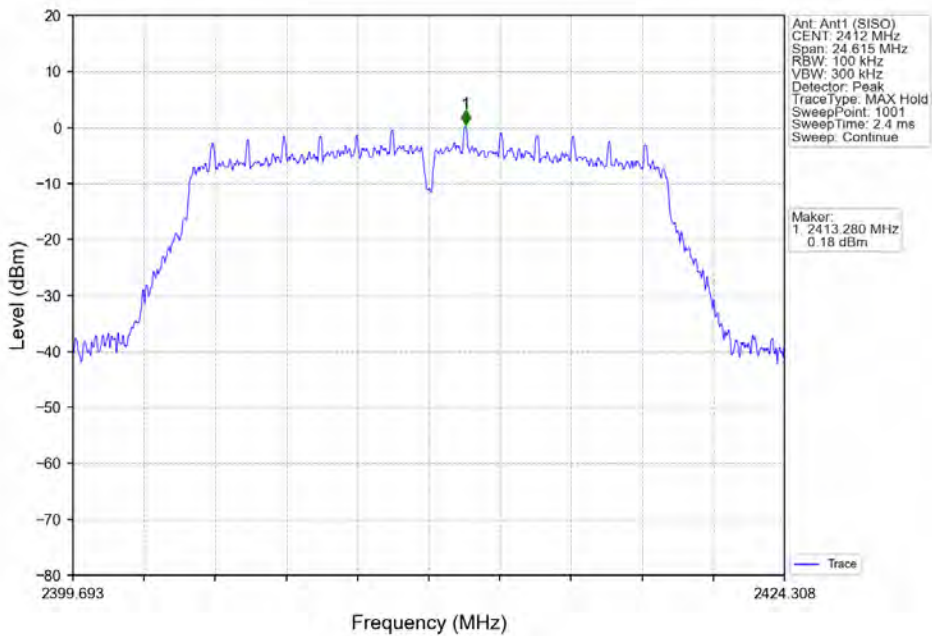

802.11g\_MCH\_2437MHz\_Ant1 (SISO)\_NTNV

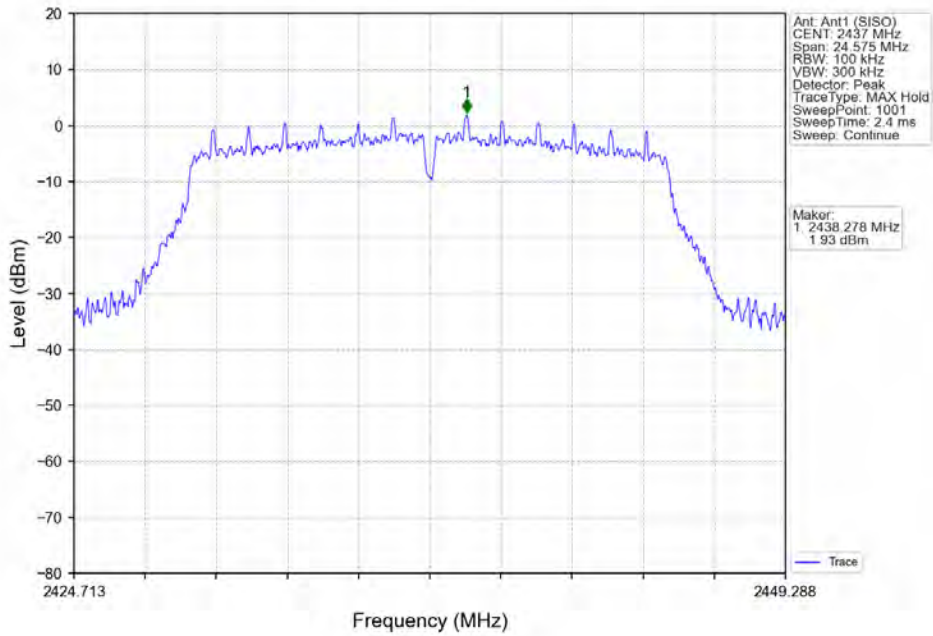

802.11g\_HCH\_2462MHz\_Ant1 (SISO)\_NTNV

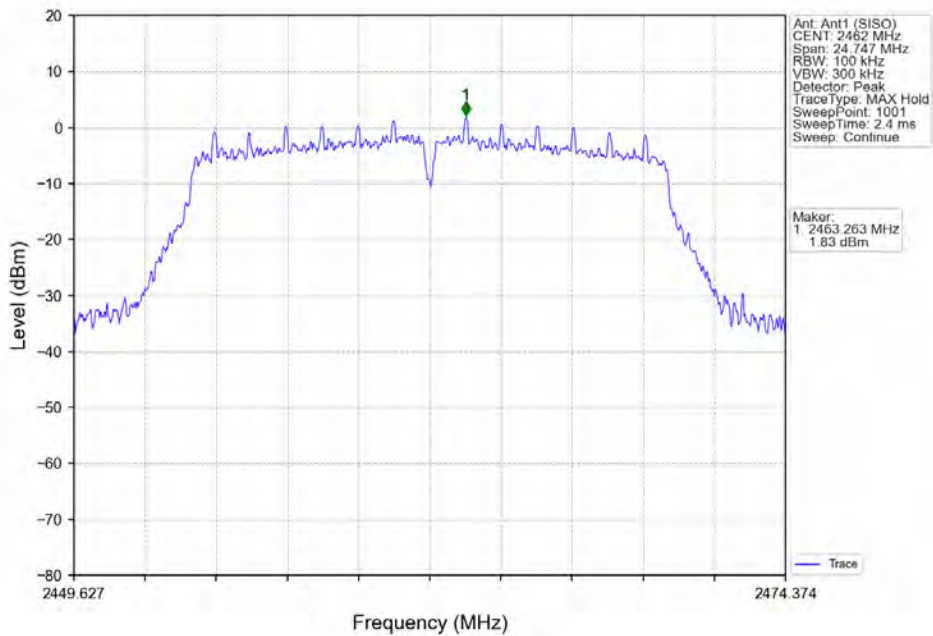

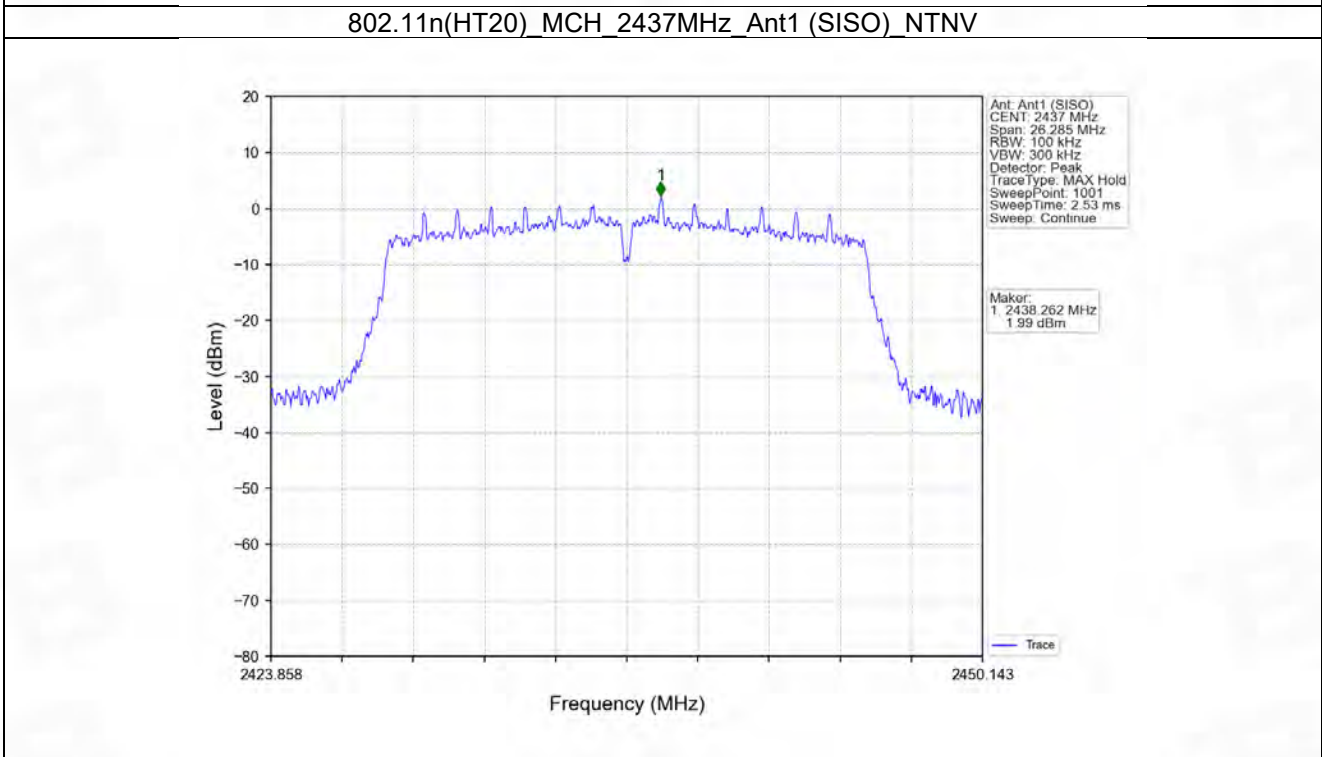
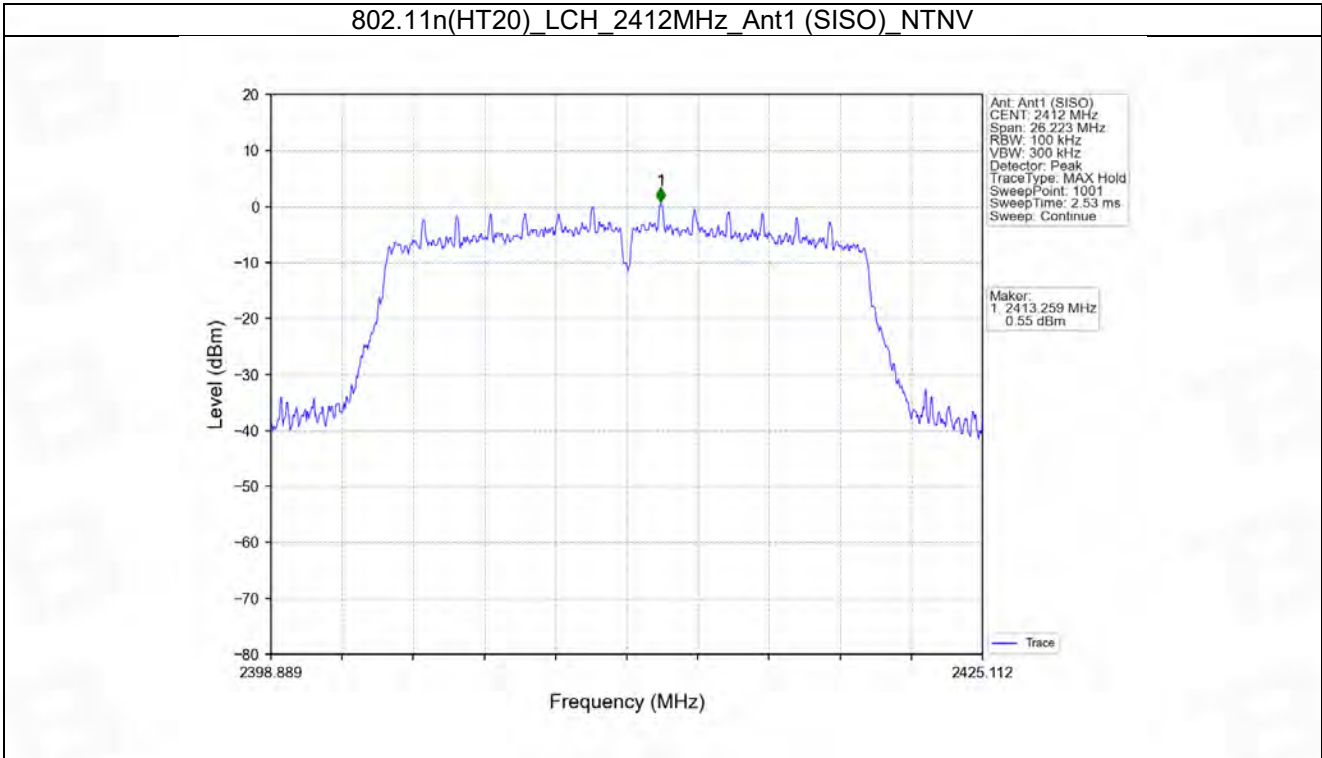

802.11n(HT20)\_HCH\_2462MHz\_Ant1 (SISO)\_NTNV

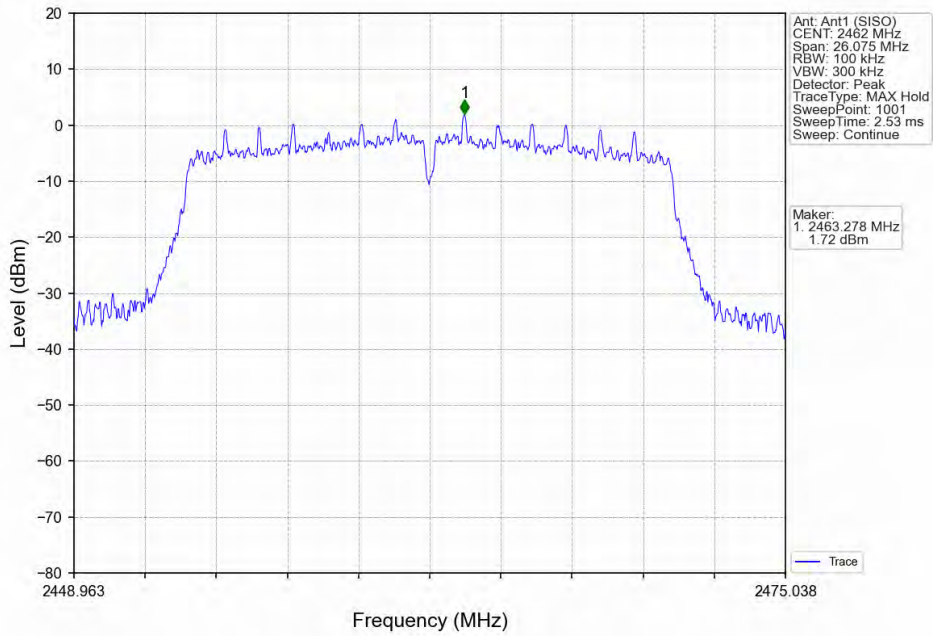

802.11n(HT40)\_LCH\_2422MHz\_Ant1 (SISO)\_NTNV

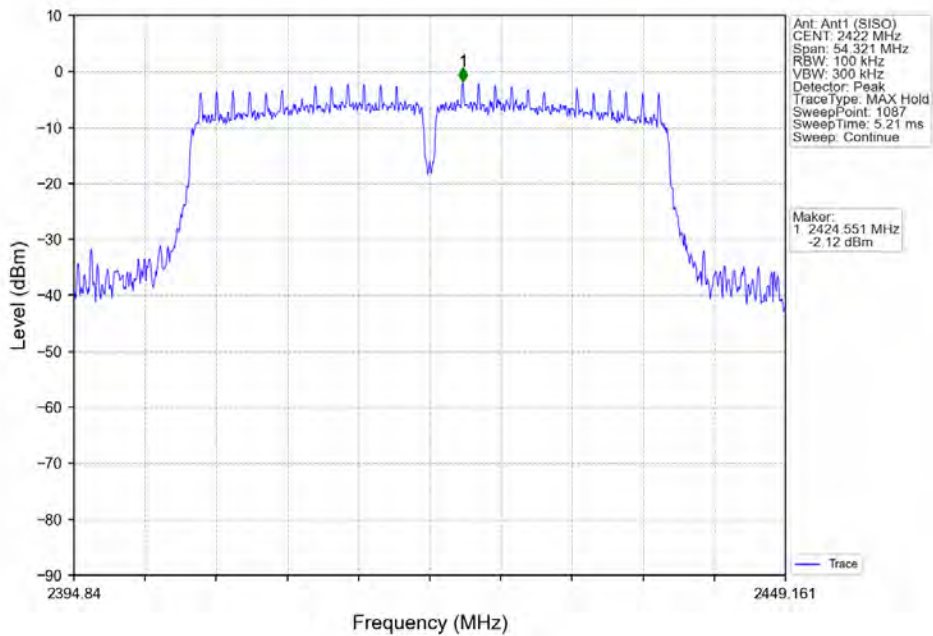

802.11n(HT40)\_MCH\_2437MHz\_Ant1 (SISO)\_NTNV

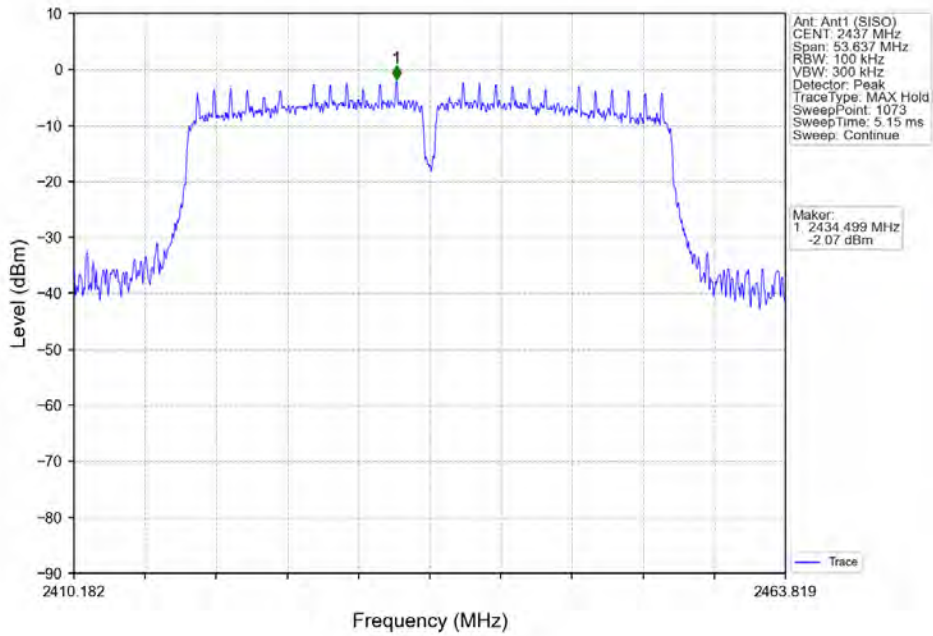

802.11n(HT40)\_HCH\_2452MHz\_Ant1 (SISO)\_NTNV

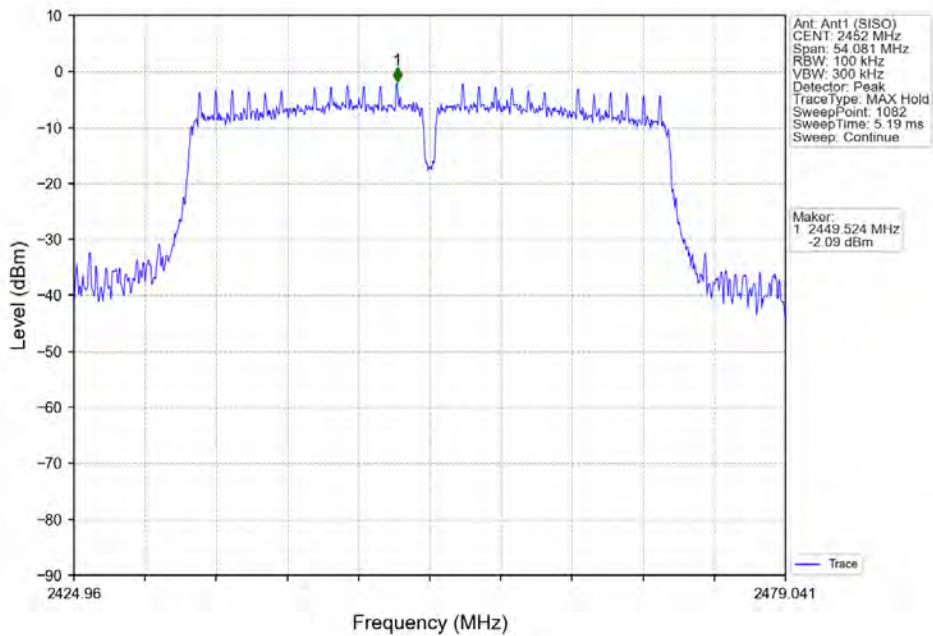



## 5.2 CSE

### 5.2.1 Test Result

Mode	TX Type	Frequency (MHz)	ANT	Level of Reference (dBm)	Limit (dBm)	Verdict
802.11b	SISO	2412	1	5.44	-14.56	Pass
		2437	1	5.44	-14.56	Pass
		2462	1	5.44	-14.56	Pass
802.11g	SISO	2412	1	1.93	-18.07	Pass
		2437	1	1.93	-18.07	Pass
		2462	1	1.93	-18.07	Pass
802.11n (HT20)	SISO	2412	1	1.99	-18.01	Pass
		2437	1	1.99	-18.01	Pass
		2462	1	1.99	-18.01	Pass
802.11n (HT40)	SISO	2422	1	-2.07	-22.07	Pass
		2437	1	-2.07	-22.07	Pass
		2452	1	-2.07	-22.07	Pass

Note1: Refer to FCC Part 15.247 (d) and ANSI C63.10-2013, the channel contains the maximum PSD level was used to establish the reference level.

5.2.2 Test Graph

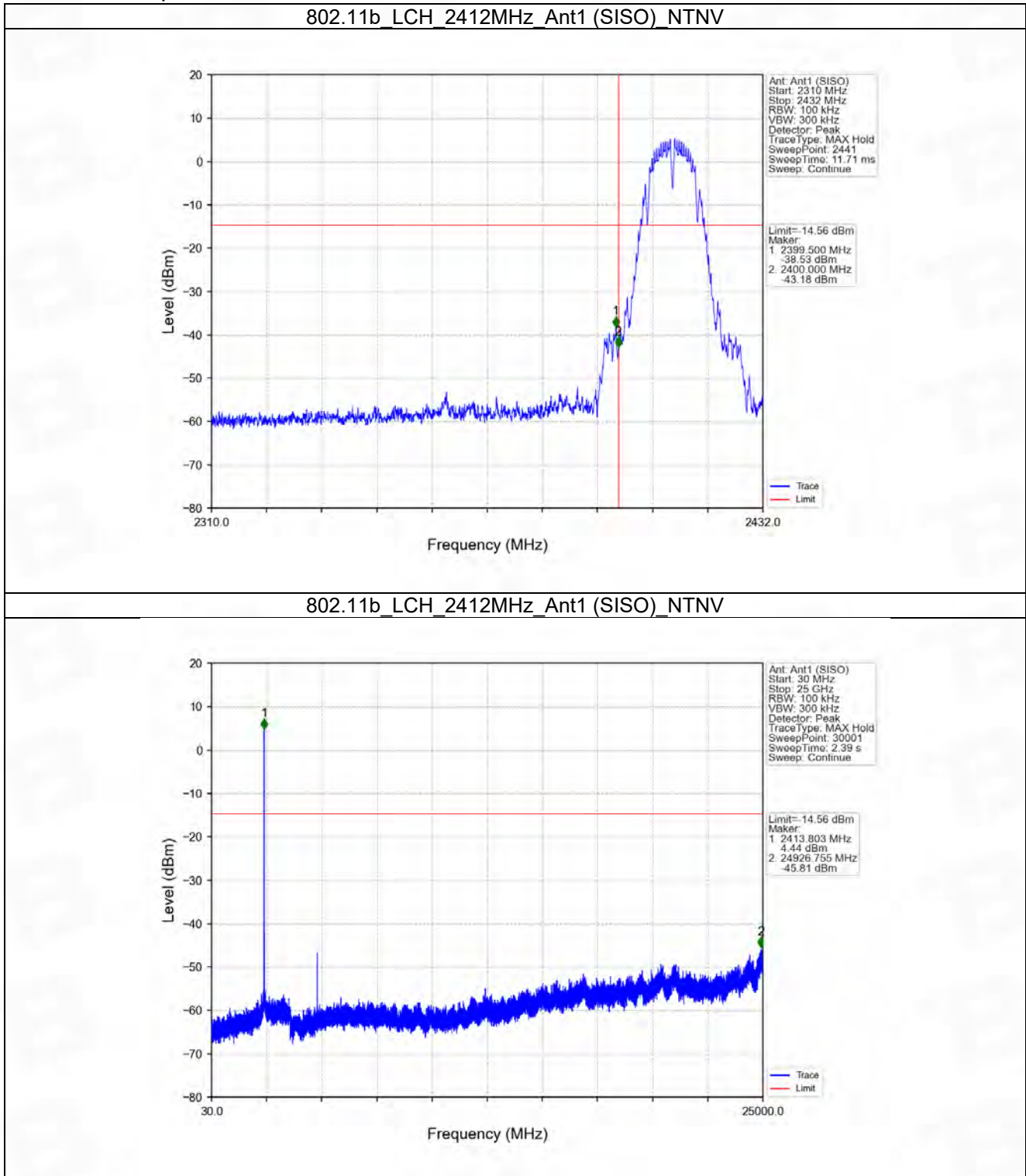

802.11b\_MCH\_2437MHz\_Ant1 (SISO)\_NTNV

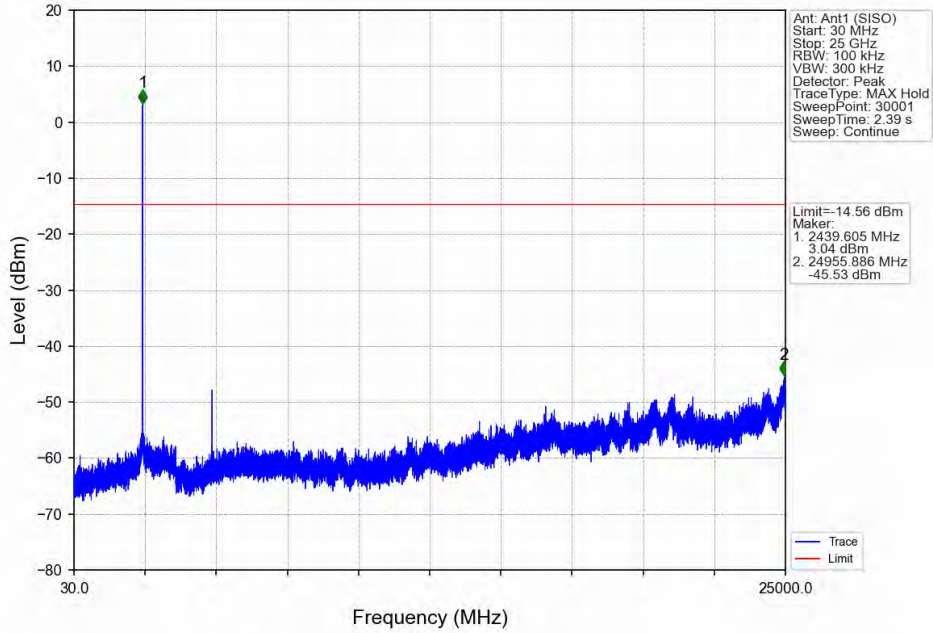

802.11b\_HCH\_2462MHz\_Ant1 (SISO)\_NTNV

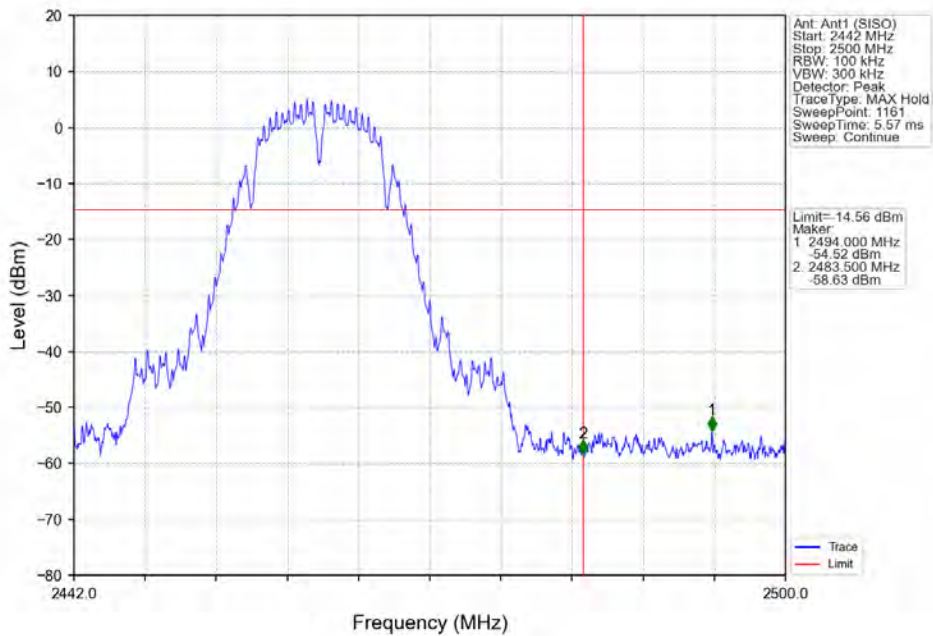

802.11b\_HCH\_2462MHz\_Ant1 (SISO)\_NTNV

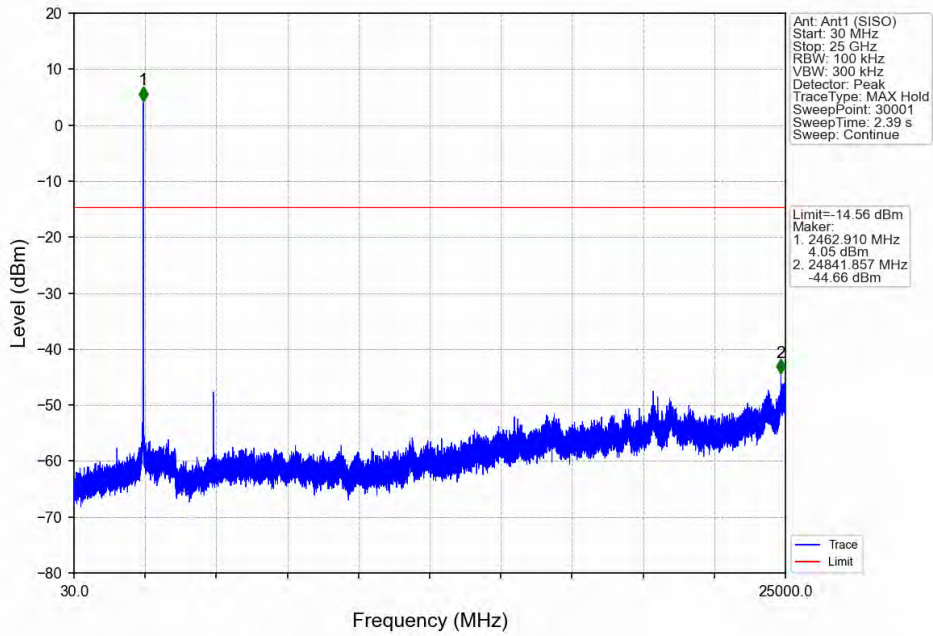

802.11g\_LCH\_2412MHz\_Ant1 (SISO)\_NTNV

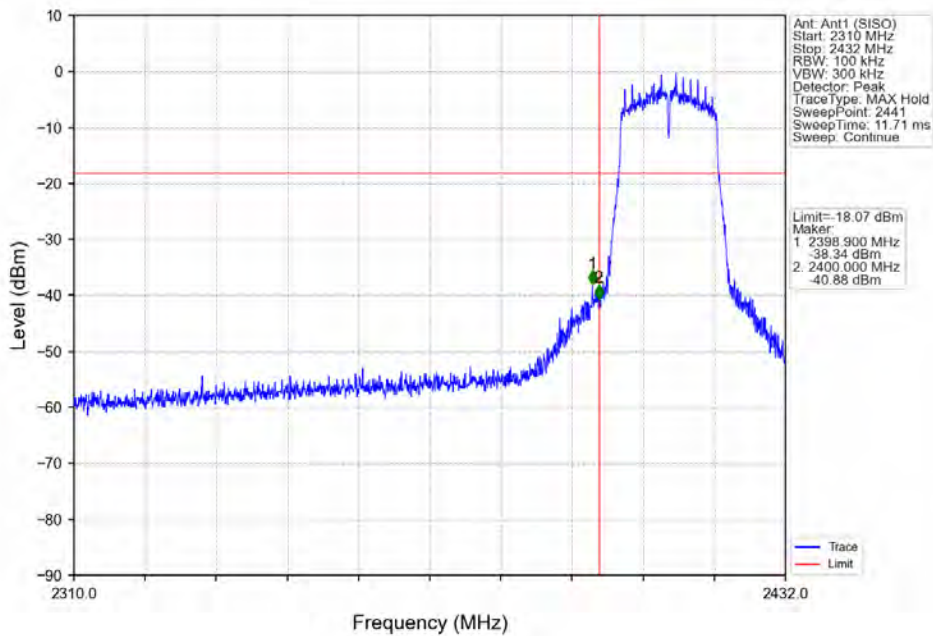

802.11g\_LCH\_2412MHz\_Ant1 (SISO)\_NTNV

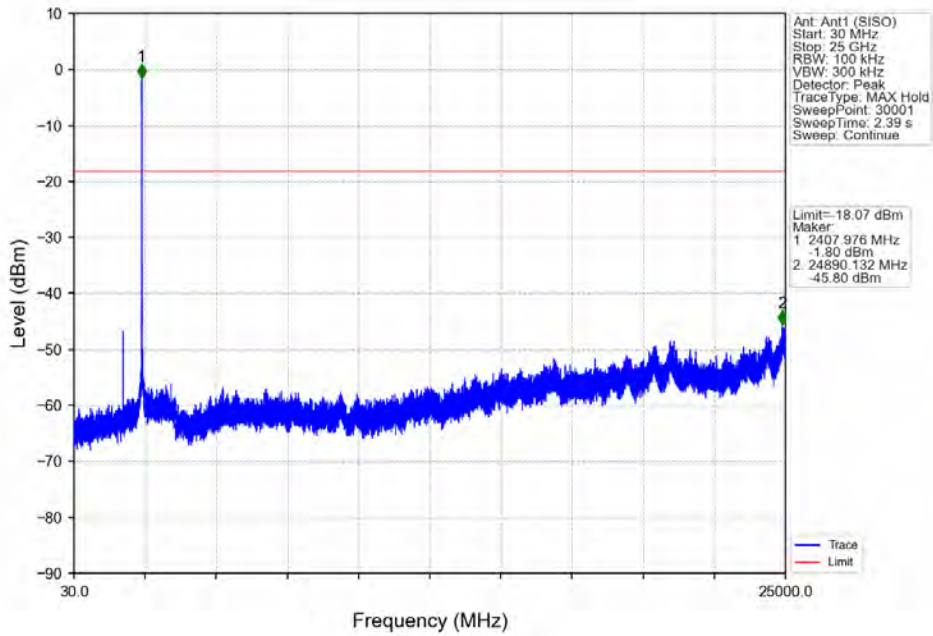

802.11g\_MCH\_2437MHz\_Ant1 (SISO)\_NTNV

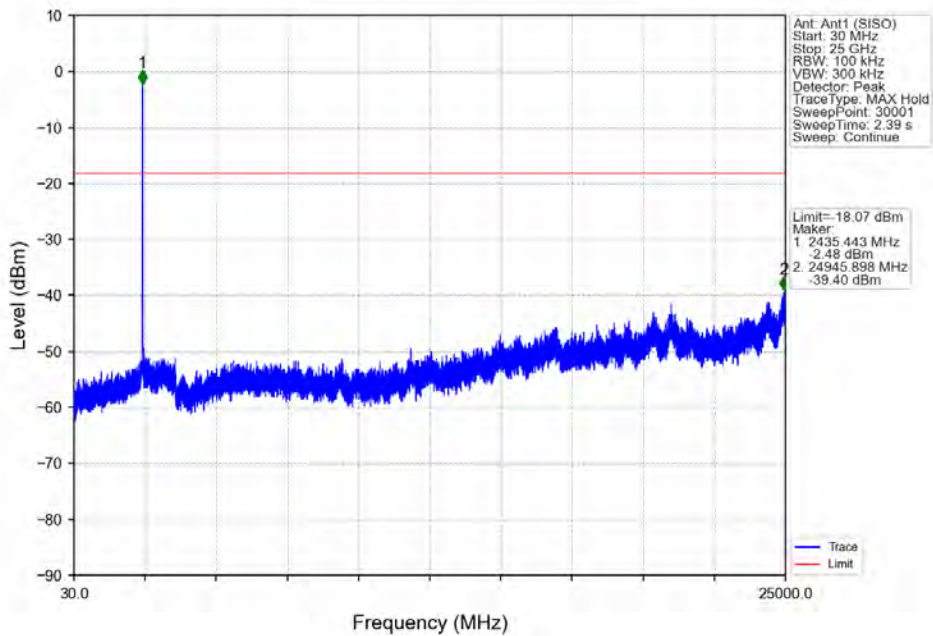

802.11g\_HCH\_2462MHz\_Ant1 (SISO)\_NTNV

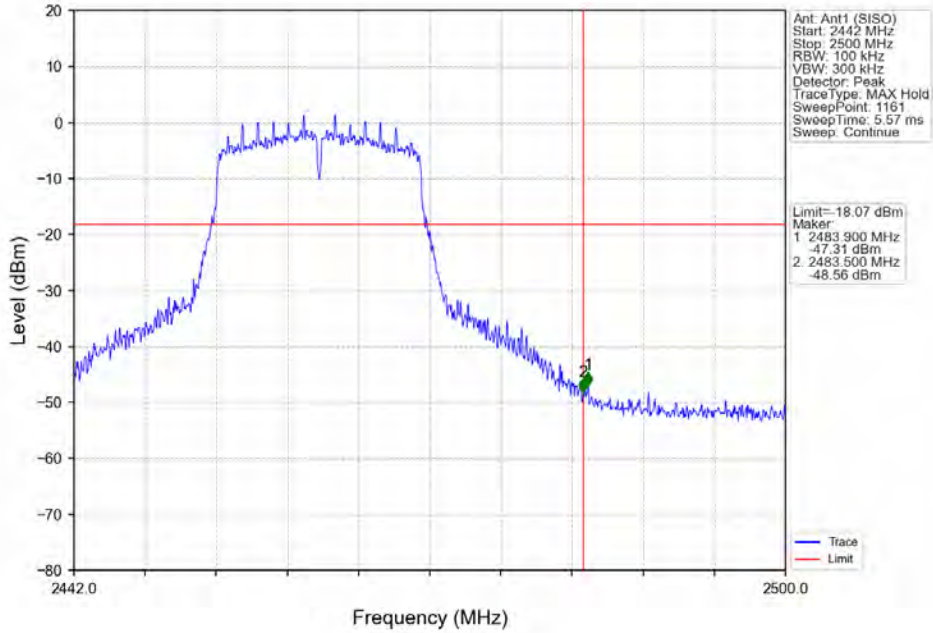

802.11g\_HCH\_2462MHz\_Ant1 (SISO)\_NTNV

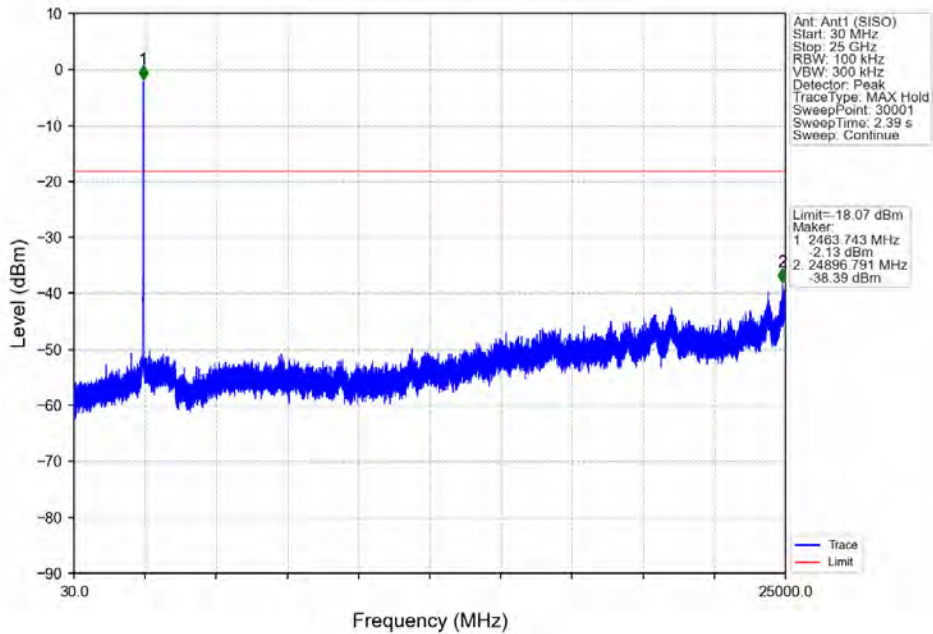

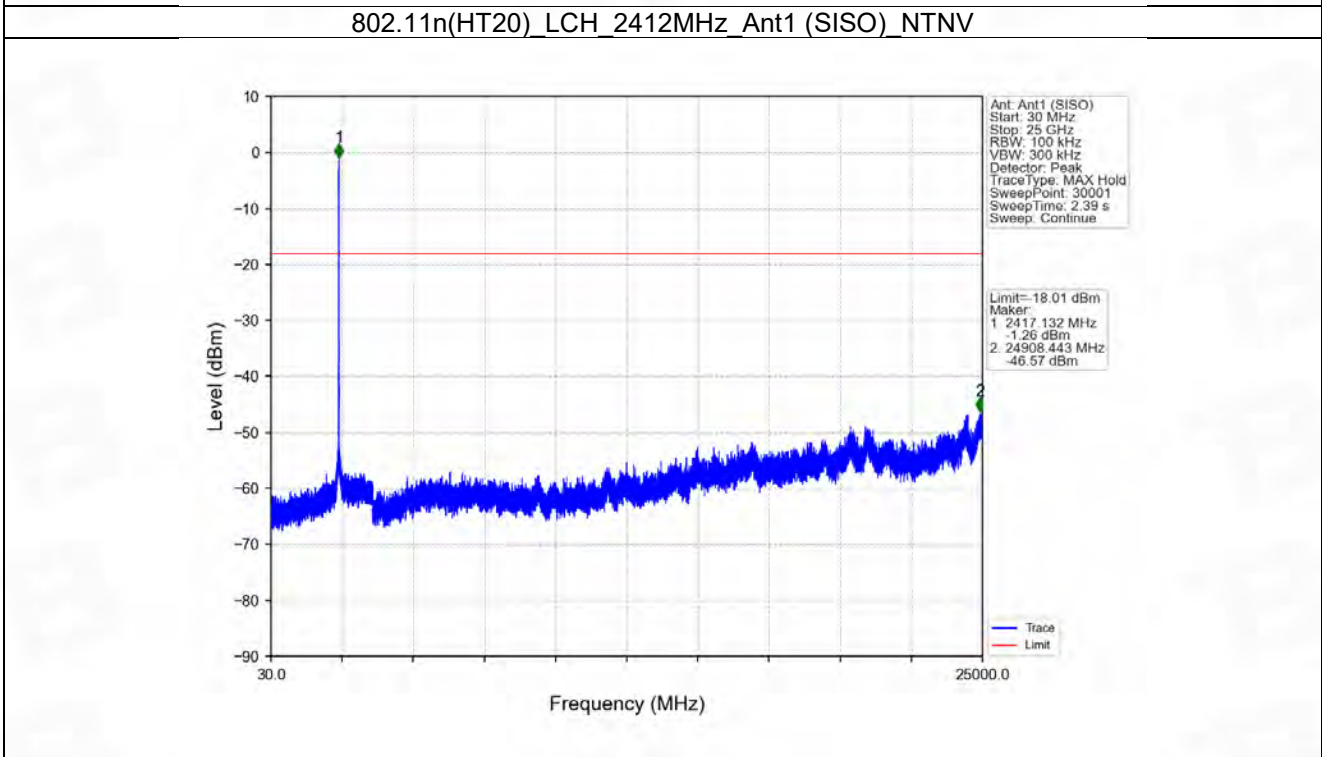
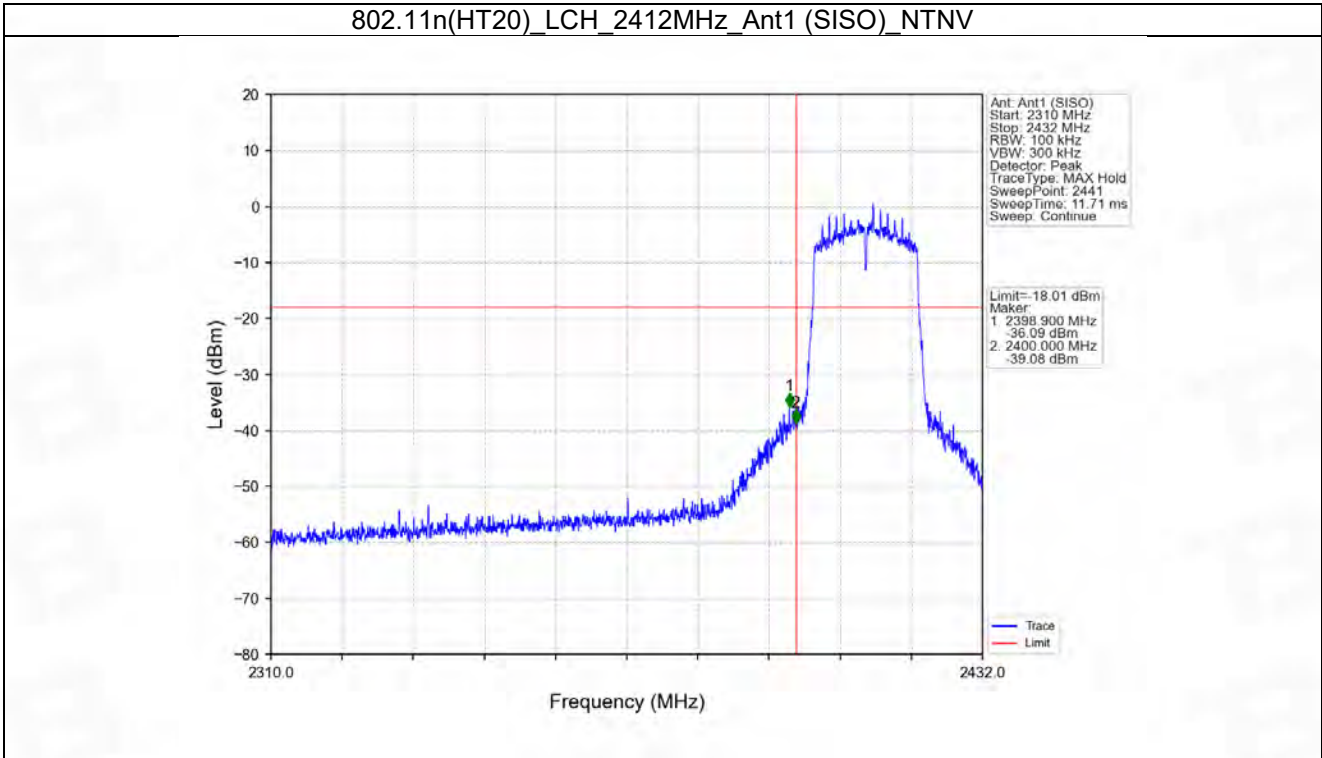

802.11n(HT20)\_MCH\_2437MHz\_Ant1 (SISO)\_NTNV

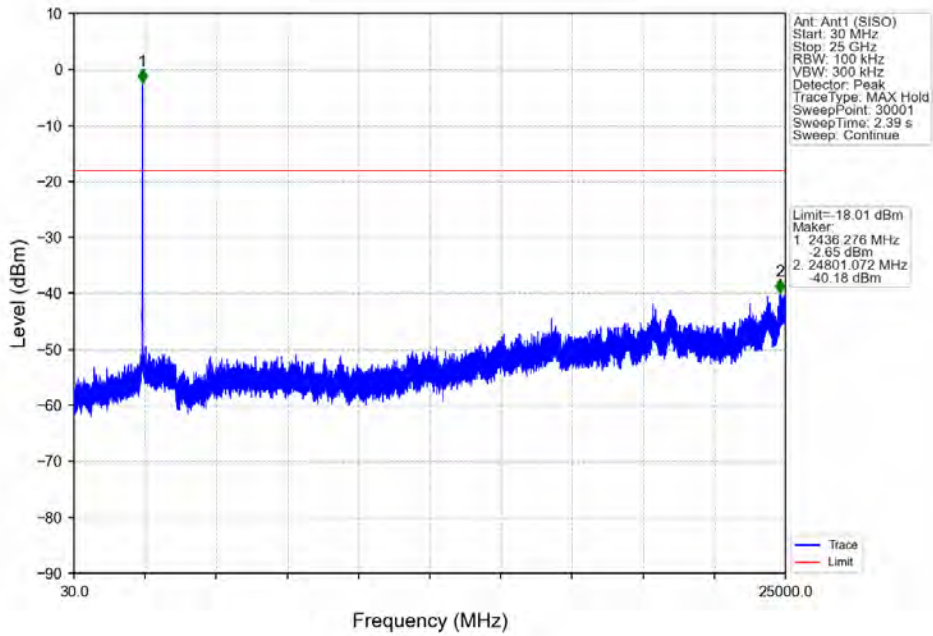

802.11n(HT20)\_HCH\_2462MHz\_Ant1 (SISO)\_NTNV

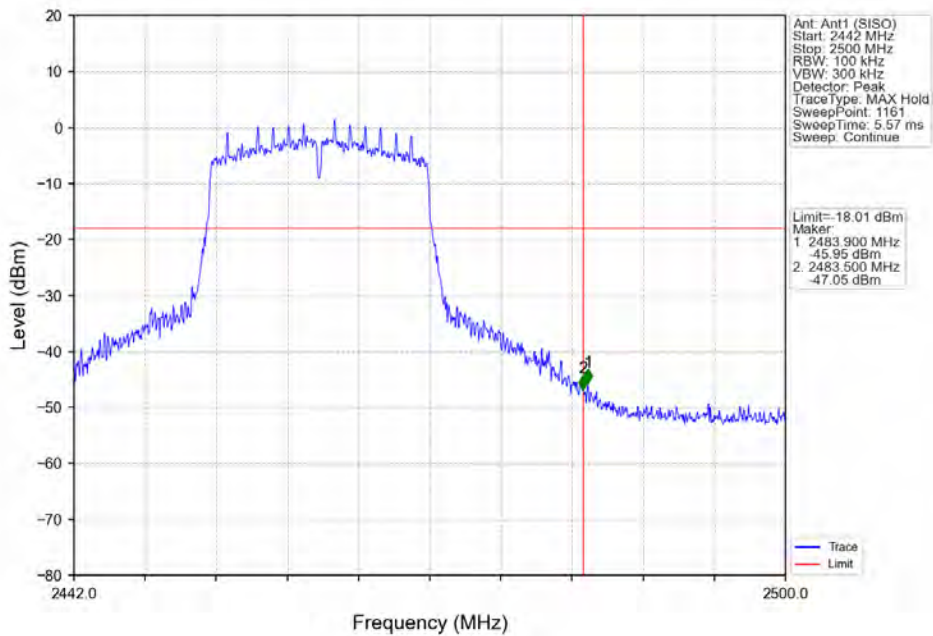



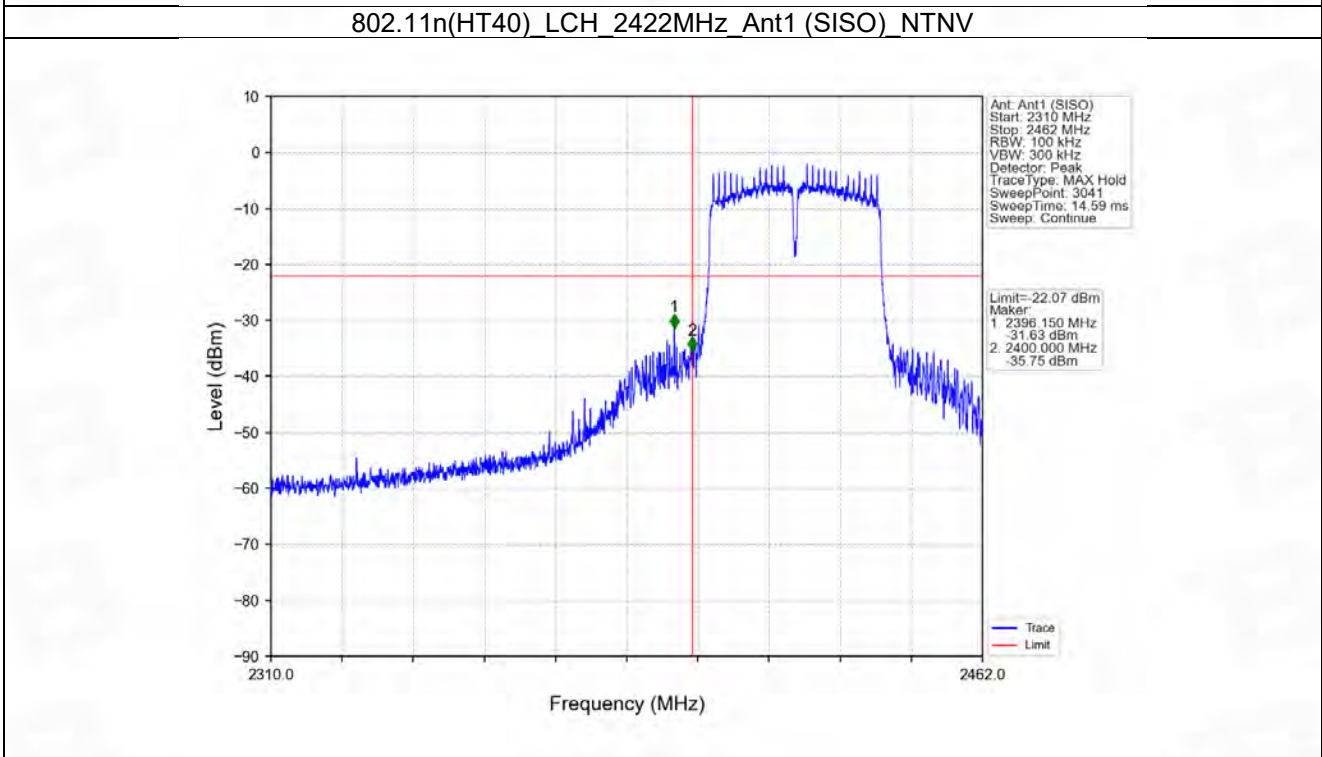
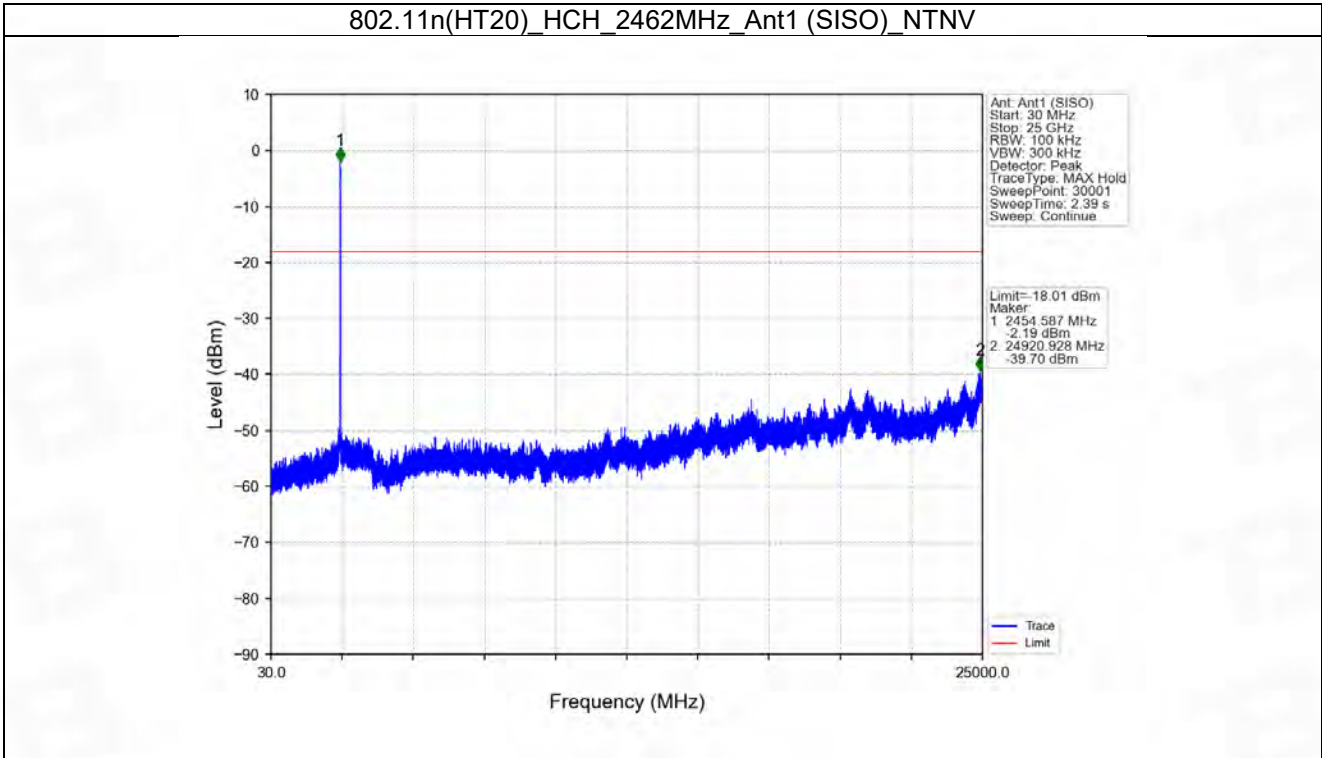

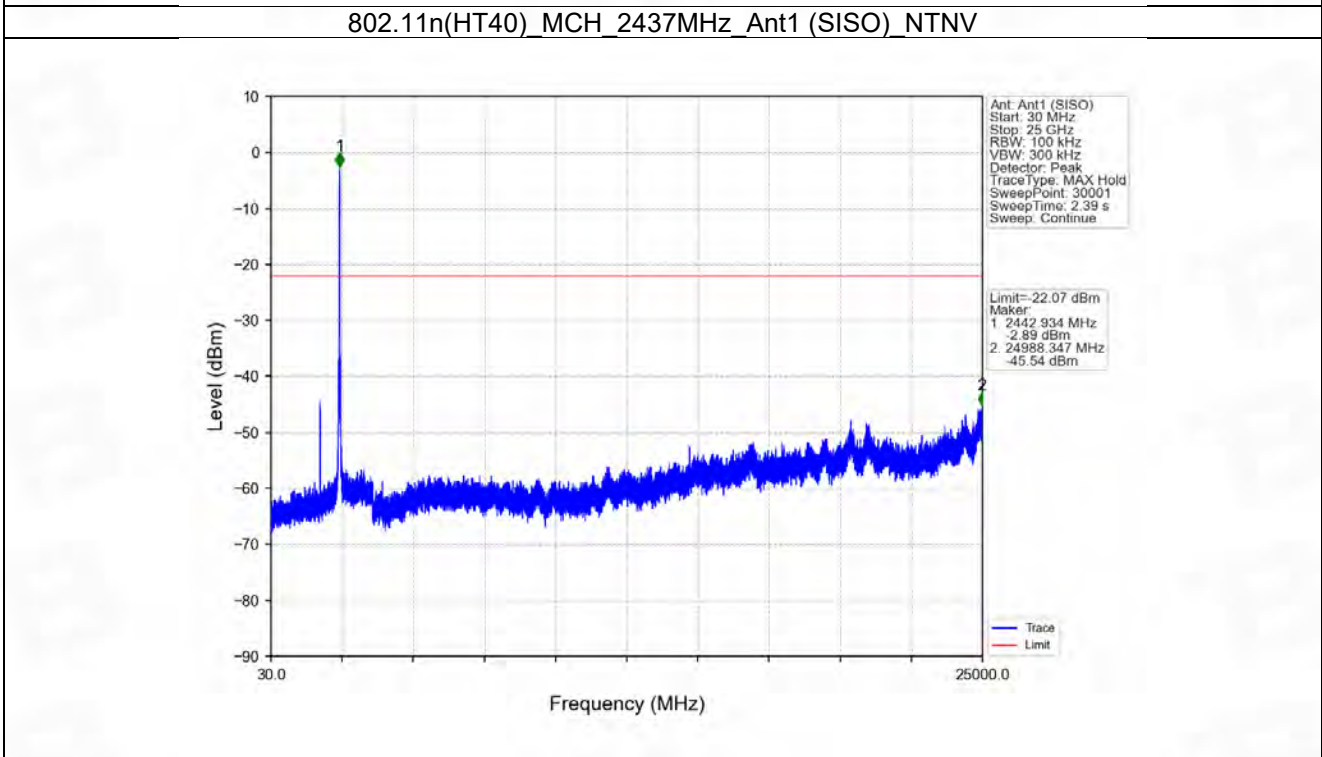
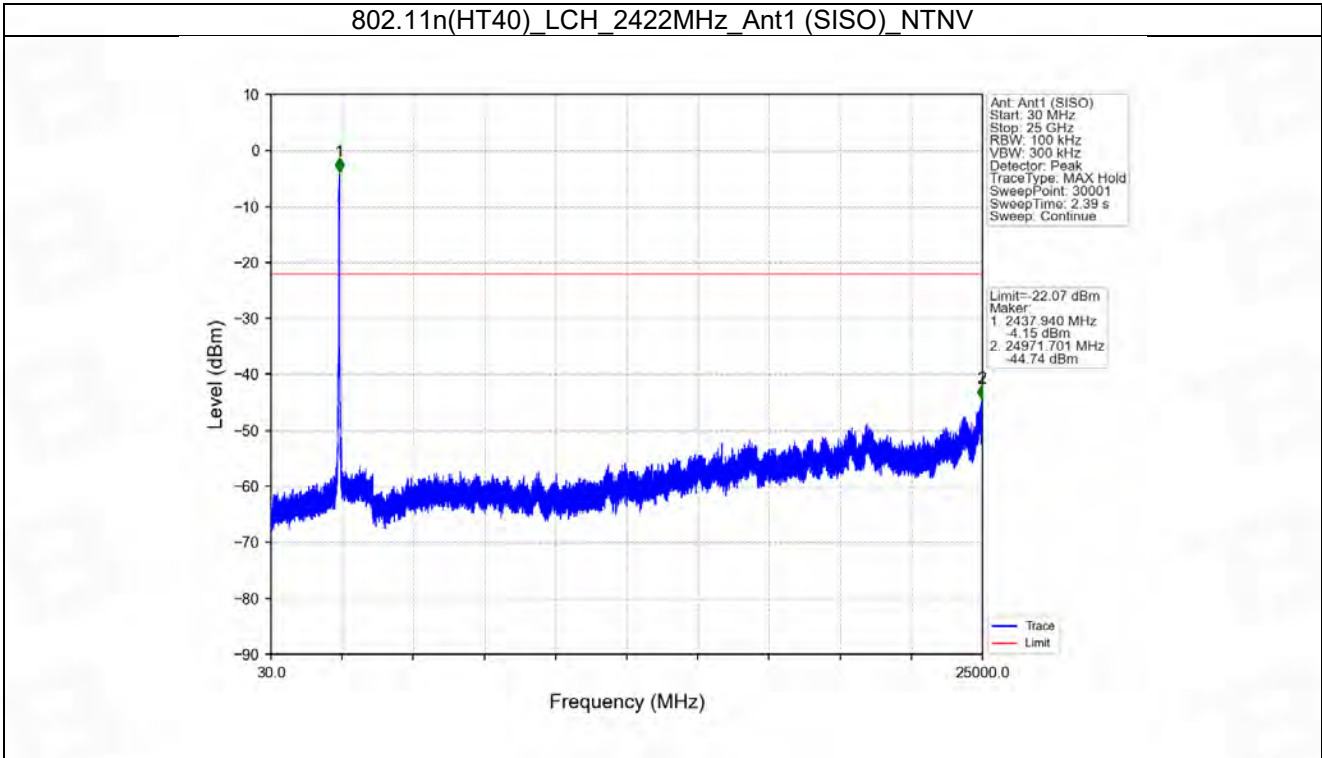

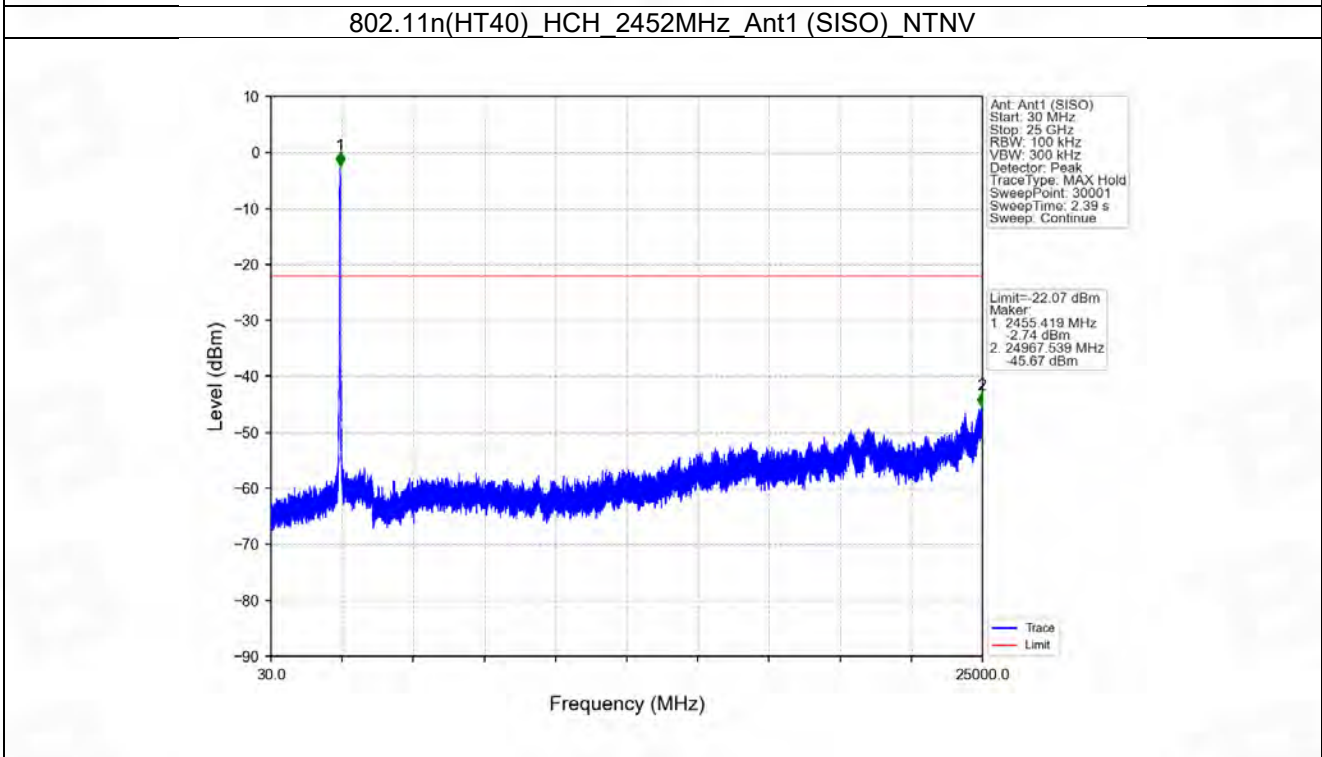
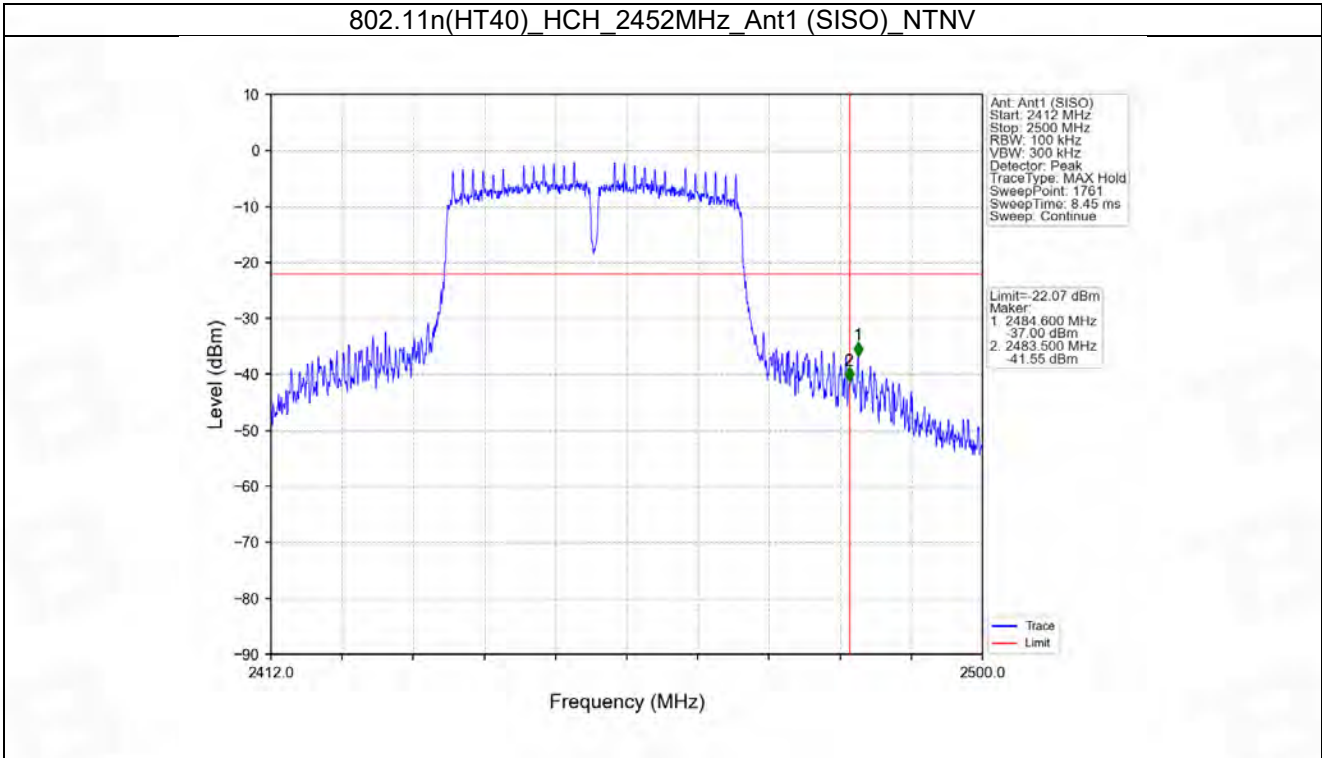

## 6. Form731

### 6.1 Form731

#### 6.1.1 Test Result

Lower Freq (MHz)	High Freq (MHz)	MAX Power (W)	MAX Power (dBm)
2412	2462	0.0906	19.57
2422	2452	0.0904	19.56



Test Report Number: BTF240419R00903



BTF Testing Lab (Shenzhen) Co., Ltd.

F101, 201 and 301, Building 1, Block 2, Tantou Industrial Park, Tantou Community, Songgang Street,  
Bao'an District, Shenzhen, China

[www.btf-lab.com](http://www.btf-lab.com)

**-- END OF REPORT --**