



Shenzhen Global Test Service Co.,Ltd.

No.7-101 and 8A-104, Building 7 and 8, DCC Cultural and Creative Garden, No.98, Pingxin North Road, Shangmugu Community, Pinghu Street, Longgang District, Shenzhen, Guangdong

FCC PART 15 SUBPART C TEST REPORT

FCC PART 15.407

Report Reference No.....: GTS20241014025-3-04

FCC ID.....: 2AQAA-J1

Compiled by
(position+printed name+signature) .: File administrators Peter Xiao

Supervised by
(position+printed name+signature) .: Test Engineer Evan Ouyang

Approved by
(position+printed name+signature) .: Manager Jason Hu



Date of issue: Dec.11, 2024

Representative Laboratory Name.: Shenzhen Global Test Service Co.,Ltd.
Address: No.7-101 and 8A-104, Building 7 and 8, DCC Cultural and Creative Garden, No.98, Pingxin North Road, Shangmugu Community, Pinghu Street, Longgang District, Shenzhen, Guangdong,China

Applicant's name.....: Shenzhen Jumper Technology Co., Ltd.
Address: Room B601, C601, JMD Industrial Park, No. 39 Qingfeng Blvd., Baolong Community, Baolong Street, Longgang District, Shenzhen, China

Test specification
Standard.....: **FCC Part 15.407: General technical requirements**
TRF Originator.....: Shenzhen Global Test Service Co.,Ltd.
Master TRF: Dated 2014-12

Shenzhen Global Test Service Co.,Ltd. All rights reserved.
This publication may be reproduced in whole or in part for non-commercial purposes as long as the Shenzhen Global Test Service Co.,Ltd. is acknowledged as copyright owner and source of the material. Shenzhen Global Test Service Co.,Ltd. takes no responsibility for and will not assume liability for damages resulting from the reader's interpretation of the reproduced material due to its placement and context.

Test item description **Laptop**
Trade Mark: N/A
Manufacturer: Shenzhen Jumper Technology Co., Ltd.
Model/Type reference: J1
Listed Models: N/A
Operation Frequency.....: From 5180MHz to 5240MHz/ 5745MHz to 5825MHz
Hardware Version: N/A
Software Version: N/A
Rating: DC 7.6V by battery
Recharged by DC 12.0V
Result: **PASS**

TEST REPORT

Test Report No. : GTS20241014025-3-04	Dec.11, 2024 Date of issue
--	-------------------------------

Equipment under Test : Laptop

Model /Type : J1

Listed model : N/A

Applicant : **Shenzhen Jumper Technology Co., Ltd.**

Address : Room B601, C601, JMD Industrial Park, No. 39 Qingfeng Blvd.,
Baolong Community, Baolong Street, Longgang District, Shenzhen,
China

Manufacturer : **Shenzhen Jumper Technology Co., Ltd.**

Address : Room B601, C601, JMD Industrial Park, No. 39 Qingfeng Blvd.,
Baolong Community, Baolong Street, Longgang District, Shenzhen,
China

Test Result:	PASS
---------------------	-------------

The test report merely corresponds to the test sample.
It is not permitted to copy extracts of these test result without the written permission of the test laboratory.

Contents

1. TEST STANDARDS	4
2. SUMMARY	5
2.1. General Remarks	5
2.2. Product Description	5
2.3. Equipment Under Test	7
2.4. Short description of the Equipment under Test (EUT)	7
2.5. EUT operation mode	7
2.6. Block Diagram of Test Setup	8
2.7. Related Submittal(s) / Grant (s)	8
2.8. EUT Exercise Software	8
2.9. Special Accessories	8
2.10. External I/O Cable	8
2.11. Modifications	8
3. TEST ENVIRONMENT	9
3.1. Address of the test laboratory	9
3.2. Test Facility	9
3.3. Environmental conditions	9
3.4. Statement of the measurement uncertainty	9
3.5. Test Description	10
3.6. Equipments Used during the Test.....	11
4. TEST CONDITIONS AND RESULTS	12
4.1. AC Power Conducted Emission	12
4.2. Radiated Emission	14
4.3. Duty Cycle	20
4.4. Maximum Average Output Power	21
4.5. Power Spectral Density	24
4.6. 99% and 6dB Bandwidth	27
4.7. 99% and 26dBc Bandwidth	28
4.8. Conducted Spurious Emissions and Band Edge Compliance	29
4.9. Frequency Stability.....	33
4.10. Antenna Requirement	36
5. TEST SETUP PHOTOS OF THE EUT.....	37
6. EXTERNAL AND INTERNAL PHOTOS OF THE EUT	37

1. TEST STANDARDS

The tests were performed according to following standards:

[FCC Rules Part 15.407](#): General technical requirements.

[ANSI C63.10-2020](#): American National Standard for Testing Unlicensed Wireless Devices

[KDB 789033 D02 General U-NII Test Procedures New Rules v02r01](#): UNII, U-NII, U-NII Test Procedures

2. SUMMARY

2.1. General Remarks

Date of receipt of test sample	:	Nov.07, 2024
Testing commenced on	:	Nov.07, 2024
Testing concluded on	:	Dec.10, 2024

2.2. Product Description

Product Name:	Laptop
Trade Mark:	N/A
Model/Type reference:	J1
List Model:	N/A
Model Declaration	N/A
Power supply:	DC 7.6V by battery Recharged by DC 12.0V
Hardware Version	N/A
Software Version	N/A
Sample ID	GTS20241014025-3-S0001-1# >S20241014025-3-S0001-2#
Bluetooth	
Frequency Range	2402MHz ~ 2480MHz
Channel Number	79 channels for Bluetooth (DSS) 40 channels for Bluetooth (DTS)
Channel Spacing	1MHz for Bluetooth (DSS) 2MHz for Bluetooth (DTS)
Modulation Type	GFSK, $\pi/4$ -DQPSK, 8DPSK for Bluetooth (DSS) GFSK for Bluetooth (DTS)
2.4GWLAN	
WLAN Operation frequency	IEEE 802.11b:2412-2462MHz IEEE 802.11g:2412-2462MHz IEEE 802.11n HT20:2412-2462MHz IEEE 802.11n HT40:2422-2452MHz IEEE 802.11ax HE20:2412-2462MHz IEEE 802.11ax HE40:2422-2452MHz
WLAN Modulation Type	IEEE 802.11b: DSSS(CCK,DQPSK,DBPSK) IEEE 802.11g: OFDM(64QAM, 16QAM, QPSK, BPSK) IEEE 802.11n HT20: OFDM (64QAM, 16QAM, QPSK,BPSK) IEEE 802.11n HT40: OFDM (64QAM, 16QAM, QPSK,BPSK) IEEE 802.11ax HE20: OFDMA (1024QAM,256QAM,64QAM,16QAM, QPSK,BPSK) IEEE 802.11ax HE40: OFDMA (1024QAM,256QAM,64QAM,16QAM, QPSK,BPSK)
Channel number:	13 Channel for IEEE 802.11b/g/n/ax(HT20) 9 Channel for IEEE 802.11n/ax (HT40)
Channel separation:	5MHz
WIFI(5.2G/5.3G/5.7G/5.8G Band)	
WLAN Operation frequency	5180-5240MHz/ 5745MHz to 5825MHz
WLAN Modulation Type	IEEE 802.11a: OFDM(64QAM, 16QAM, QPSK, BPSK) IEEE 802.11n HT20: OFDM (64QAM, 16QAM, QPSK,BPSK) IEEE 802.11n HT40: OFDM (64QAM, 16QAM, QPSK,BPSK)

	<p>IEEE 802.11ac VHT20: OFDM (256QAM, 64QAM, 16QAM, QPSK, BPSK) IEEE 802.11ac VHT40: OFDM (256QAM, 64QAM, 16QAM, QPSK, BPSK) IEEE 802.11ac VHT80: OFDM (256QAM, 64QAM, 16QAM, QPSK, BPSK) IEEE 802.11ax HE20: OFDMA (1024QAM, 256QAM, 64QAM, 16QAM, QPSK, BPSK) IEEE 802.11ax HE40: OFDMA (1024QAM, 256QAM, 64QAM, 16QAM, QPSK, BPSK) IEEE 802.11ax HE80: OFDMA (1024QAM, 256QAM, 64QAM, 16QAM, QPSK, BPSK)</p>
<p>Channel number:</p>	<p>4 Channels for 20MHz bandwidth(5180-5240MHz) 5 channels for 20MHz bandwidth(5745-5825MHz) 2 channels for 40MHz bandwidth(5190~5230MHz) 2 channels for 40MHz bandwidth(5755~5795MHz) 1 channels for 80MHz bandwidth(5210MHz) 1 channels for 80MHz bandwidth(5775MHz)</p>
<p>Antenna Description</p>	<p>Two FPC antennas; WLAN support 2*2MIMO technology ANT1 used for Bluetooth & WIFI TX/RX, 2.0 dBi(Max.) for 2.4G Band and 2.0 dBi(Max.) for 5G Band ANT2 used for WIFI TX/RX, 2.0 dBi(Max.) for 2.4G Band and 2.0 dBi(Max.) for 5G Band</p>

2.3. Equipment Under Test

Power supply system utilised

Power supply voltage	:	<input type="radio"/> 230V / 50 Hz	<input type="radio"/> 120V / 60Hz
		<input type="radio"/> 12 V DC	<input type="radio"/> 24 V DC
		<input checked="" type="radio"/> Other (specified in blank below)	

DC 7.6V

2.4. Short description of the Equipment under Test (EUT)

This is a Laptop.

For more details, refer to the user's manual of the EUT.

2.5. EUT operation mode

The application provider specific test software to control sample in continuous TX and RX.

Antenna	Chain0 (ANT 1)			Chain1 (ANT 2)			Simultaneously
Bandwidth Mode	20MHz	40MHz	80MHz	20MHz	40MHz	80MHz	/
IEEE 802.11a	<input checked="" type="checkbox"/>	<input type="checkbox"/>	<input type="checkbox"/>	<input checked="" type="checkbox"/>	<input type="checkbox"/>	<input type="checkbox"/>	<input type="checkbox"/>
IEEE 802.11n	<input checked="" type="checkbox"/>	<input checked="" type="checkbox"/>	<input type="checkbox"/>	<input checked="" type="checkbox"/>	<input checked="" type="checkbox"/>	<input type="checkbox"/>	<input type="checkbox"/>
IEEE 802.11ac	<input checked="" type="checkbox"/>	<input checked="" type="checkbox"/>	<input checked="" type="checkbox"/>	<input checked="" type="checkbox"/>	<input checked="" type="checkbox"/>	<input checked="" type="checkbox"/>	<input type="checkbox"/>
IEEE 802.11ax	<input checked="" type="checkbox"/>	<input checked="" type="checkbox"/>	<input checked="" type="checkbox"/>	<input checked="" type="checkbox"/>	<input checked="" type="checkbox"/>	<input checked="" type="checkbox"/>	<input type="checkbox"/>

IEEE 802.11a/ac20/ac40/ac80/ax20/ax40/ax80/n20/n40:

UNII-1		UNII-1		UNII-1	
Channel	Frequency (MHz)	Channel	Frequency (MHz)	Channel	Frequency (MHz)
36	5180	38	5190	42	5210
40	5200	46	5230		
44	5220				
48	5240				

U-NI-3		U-NI-3		U-NI-3	
Channel	Frequency (MHz)	Channel	Frequency (MHz)	Channel	Frequency (MHz)
149	5745	151	5755	155	5775
153	5765	159	5795		
157	5785				
161	5805				
165	5825				

The EUT has been tested under operating condition.

This test was performed with EUT in X, Y, Z position and the worst case was found when EUT in X position.

AC main conducted emission pre-test voltage at both AC 120V/60Hz and AC 240V/50Hz, recorded worst case(AC 120V/60Hz);

AC main conducted emission pre-test at charge from PC modes, recorded worst case;

Worst-case mode and channel used for 9 KHz-1000 MHz radiated emissions was the mode and channel with the highest output power, that was determined to be IEEE 802.11ac VHT20 mode (HCH).

AX mode tested all RU, only worst case mode (Full RU) recorded in report.

2.6. Block Diagram of Test Setup



2.7. Related Submittal(s) / Grant (s)

This submittal(s) (test report) is intended for **FCC ID: 2AQAA-J1** filing to comply with Section 15.407 of the FCC Part 15, Subpart E Rules.

2.8. EUT Exercise Software

The system was configured for testing in a continuous transmits condition and change test channels by software (adb model) provided by application.

2.9. Special Accessories

Manufacturer	Description	Model	Serial Number	Certificate
Shenzhen ABP Technology Co., Ltd.	Adapter	AD0361-1203000UB	--	SDOC
SONY	Earphone	MDR-XB550AP	--	SDOC
aigo	USB flash disk	U330	--	SDOC
THTF	Display	LE23CW-D	--	SDOC

Note: The Earphone, USB flash disk and Display is only used for auxiliary testing.

2.10. External I/O Cable

I/O Port Description	Quantity	Cable
DC IN Port	1	Non-Shielded, 1.0m
USB Port	3	N/A
Type-C Port	1	N/A
HDMI Port	1	Non-Shielded, 1.0m
Earphone Port	1	N/A
SD Card	1	N/A

2.11. Modifications

No modifications were implemented to meet testing criteria.

3. TEST ENVIRONMENT

3.1. Address of the test laboratory

Shenzhen Global Test Service Co.,Ltd.

No.7-101 and 8A-104, Building 7 and 8, DCC Cultural and Creative Garden, No.98, Pingxin North Road, Shangmugu Community, Pinghu Street, Longgang District, Shenzhen, Guangdong, China.

3.2. Test Facility

The test facility is recognized, certified, or accredited by the following organizations:

CNAS (No. CNAS L8169)

Shenzhen Global Test Service Co., Ltd. has been assessed and proved to be in compliance with CNAS-CL01 Accreditation Criteria for Testing and Calibration Laboratories (identical to ISO/IEC 17025: 2019 General Requirements) for the Competence of Testing and Calibration Laboratories.

A2LA (Certificate No. 4758.01)

Shenzhen Global Test Service Co., Ltd. has been assessed by the American Association for Laboratory Accreditation (A2LA). Certificate No. 4758.01.

Industry Canada Registration Number. is 24189.

FCC Designation Number is CN1234.

FCC Registered Test Site Number is165725.

3.3. Environmental conditions

During the measurement the environmental conditions were within the listed ranges:

Temperature:	15-35 ° C
Humidity:	30-60 %
Atmospheric pressure:	950-1050mbar

3.4. Statement of the measurement uncertainty

The data and results referenced in this document are true and accurate. The reader is cautioned that there may be errors within the calibration limits of the equipment and facilities. The measurement uncertainty was calculated for all measurements listed in this test report acc. to CISPR 16 - 4 „Specification for radio disturbance and immunity measuring apparatus and methods – Part 4: Uncertainty in EMC Measurements“ and is documented in the Shenzhen Global Test Service Co.,Ltd quality system acc. to DIN EN ISO/IEC 17025. Furthermore, component and process variability of devices similar to that tested may result in additional deviation. The manufacturer has the sole responsibility of continued compliance of the device.

Hereafter the best measurement capability for Shenzhen GTS laboratory is reported:

Test	Range	Measurement Uncertainty	Notes
Radiated Emission	30~1000MHz	4.10 dB	(1)
Radiated Emission	1~18GHz	4.32 dB	(1)
Radiated Emission	18-40GHz	5.54 dB	(1)
Conducted Disturbance	0.15~30MHz	3.12 dB	(1)

This uncertainty represents an expanded uncertainty expressed at approximately the 95% confidence level using a coverage factor of k=2.

3.5. Test Description

Applied Standard: FCC Part 15 Subpart E				
FCC Rules	Description of Test	Test Sample	Result	Remark
/	On Time and Duty Cycle	GTS20241014025-3-S0001-1#	Compliant	Appendix D Appendix E
§15.407(a)	Maximum Conducted Output Power	GTS20241014025-3-S0001-1#	Compliant	Appendix D Appendix E
§15.407(a)	Power Spectral Density	GTS20241014025-3-S0001-1#	Compliant	Appendix D Appendix E
§15.407(a)	26dB&6dB Bandwidth and 99% Bandwidth	GTS20241014025-3-S0001-1#	Compliant	Appendix D Appendix E
§15.209, §15.407(b)	Radiated Emissions	GTS20241014025-3-S0001-1#	Compliant	Note 1
§15.209, §15.407(b)	Conducted Spurious Emissions and Band Edges Test	GTS20241014025-3-S0001-1#	Compliant	Appendix D Appendix E
§15.209, §15.407(b)	Emissions at Restricted Band	GTS20241014025-3-S0001-1# GTS20241014025-3-S0001-2#	Compliant	Note 1
§15.407(g)	Frequency Stability	GTS20241014025-3-S0001-1#	Compliant	Note 1
§15.207(a)	AC Mians Line Conducted Emissions	GTS20241014025-3-S0001-2#	Compliant	Note 1
§15.203 §15.407(h)	Antenna Requirements	GTS20241014025-3-S0001-1#	Compliant	Note 1
§15.407 §2.1093	RF Exposure	/	Compliant	Note 2

Remark:

1. The measurement uncertainty is not included in the test result.
2. NA = Not Applicable; NP = Not Performed
3. Note 1 – Test results inside test report;
4. Note 2 – Test results in other test report (SAR Report).
5. We tested all test mode and recorded worst case in report

Preliminary tests were performed in different data rate to find the worst radiated emission. The data rate shown in the table below is the worst-case rate with respect to the specific test item. Investigation has been done on all the possible configurations for searching the worst cases. The following table is a list of the test modes shown in this test report.

Test Items	Mode	Data Rate
Maximum Peak Conducted Output Power	802.11a	6 Mbps
Power Spectral Density	802.11ac20/ac40/ac80 802.11n HT20/40/ax20/ax40/ax80	MCS0
6dB Bandwidth		
26dB Bandwidth		
Radiated Emission30M~1GHz& Radiated Emission 1GHz~10 th Harmonic		
Band Edge	802.11a	6 Mbps
	802.11ac20/ac40/ac80 802.11n HT20/40/ax20/ax40/ax80	MCS0

3.6. Equipments Used during the Test

Test Equipment	Manufacturer	Model No.	Serial No.	Calibration Date	Calibration Due Date
LISN	CYBERTEK	EM5040A	E1850400105	2024/07/15	2025/07/14
LISN	R&S	ESH2-Z5	893606/008	2024/07/15	2025/07/14
EMI Test Receiver	R&S	ESPI3	101841-cd	2024/07/15	2025/07/14
EMI Test Receiver	R&S	ESCI7	101102	2024/07/15	2025/07/14
Spectrum Analyzer	Agilent	N9020A	MY48010425	2024/07/15	2025/07/14
Spectrum Analyzer	R&S	FSV40-N	101800	2024/07/15	2025/07/14
Vector Signal generator	Agilent	N5181A	MY49060502	2024/07/15	2025/07/14
Signal generator	Agilent	N5182A	3610AO1069	2024/07/15	2025/07/14
Climate Chamber	ESPEC	EL-10KA	A20120523	2024/07/15	2025/07/14
Controller	EM Electronics	Controller EM 1000	N/A	N/A	N/A
Horn Antenna	Schwarzbeck	BBHA 9120D	01622	2024/07/15	2025/07/14
Active Loop Antenna	Beijing Da Ze Technology Co.,Ltd.	ZN30900C	15006	2024/07/15	2025/07/14
Bilog Antenna	Schwarzbeck	VULB9163	000976	2024/07/15	2025/07/14
Broadband Horn Antenna	SCHWARZBECK	BBHA 9170	791	2024/07/15	2025/07/14
Amplifier	Schwarzbeck	BBV 9743	#202	2024/01/27	2025/01/26
Amplifier	Taiwan Chengyi	EMC051845B	980355	2024/01/27	2025/01/26
Amplifier	Schwarzbeck	BBV9179	9719-025	2024/01/27	2025/01/26
Temperature/Humidity Meter	Gangxing	CTH-608	02	2024/07/15	2025/07/14
High-Pass Filter	HUBER+SUHNER	RG214	RE01	2024/07/15	2025/07/14
High-Pass Filter	HUBER+SUHNER	RG214	RE02	2024/07/15	2025/07/14
RF Cable(below 1GHz)	HUBER+SUHNER	RG214	RE01	2024/07/15	2025/07/14
RF Cable(above 1GHz)	HUBER+SUHNER	RG214	RE02	2024/07/15	2025/07/14
Data acquisition card	Agilent	U2531A	TW53323507	2024/07/15	2025/07/14
Power Sensor	Agilent	U2021XA	MY5365004	2024/07/15	2025/07/14
Test Control Unit	Tonscend	JS0806-1	178060067	2024/07/15	2025/07/14
Automated filter bank	Tonscend	JS0806-F	19F8060177	2024/07/15	2025/07/14
Wireless Communication Tester	Rohde&Schwarz	CMW500	125408	2024/07/15	2025/07/14
EMI Test Software	Tonscend	JS1120-1	Ver 2.6.8.0518	/	/
EMI Test Software	Tonscend	JS1120-3	Ver 2.5.77.0418	/	/
EMI Test Software	Tonscend	JS32-CE	Ver 2.5	/	/
EMI Test Software	Tonscend	JS32-RE	Ver 2.5.1.8	/	/

Note: The Cal.Interval was one year.

4. TEST CONDITIONS AND RESULTS

4.1. AC Power Conducted Emission

TEST CONFIGURATION

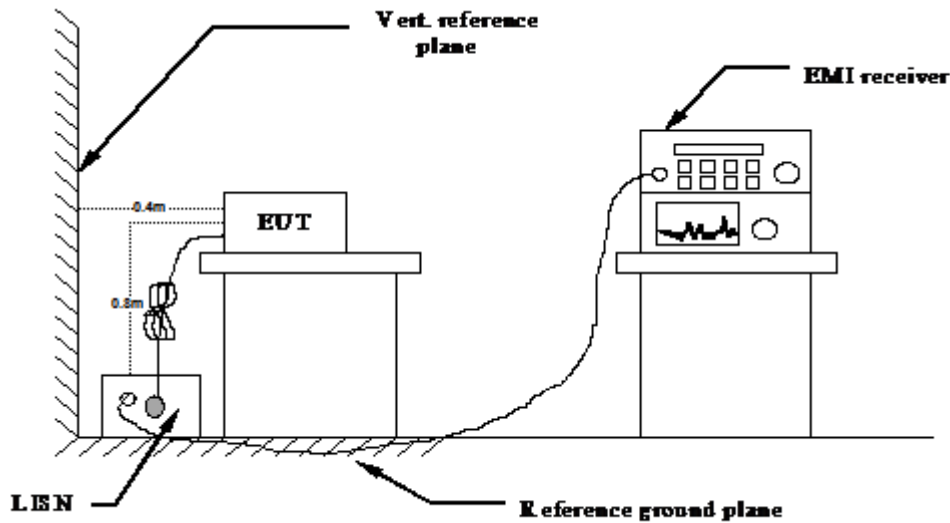

TEST PROCEDURE

- 1 The equipment was set up as per the test configuration to simulate typical actual usage per the user's manual. The EUT is a tabletop system, a wooden table with a height of 0.8 meters is used and is placed on the ground plane as per ANSI C63.10-2020.
- 2 Support equipment, if needed, was placed as per ANSI C63.10-2020
- 3 All I/O cables were positioned to simulate typical actual usage as per ANSI C63.10-2020
- 4 The EUT received DC 12.0V power, the adapter received AC120V/60Hz or AC 240V/50Hz power through a Line Impedance Stabilization Network (LISN) which supplied power source and was grounded to the ground plane.
- 5 All support equipments received AC power from a second LISN, if any.
- 6 The EUT test program was started. Emissions were measured on each current carrying line of the EUT using a spectrum Analyzer / Receiver connected to the LISN powering the EUT. The LISN has two monitoring points: Line 1 (Hot Side) and Line 2 (Neutral Side). Two scans were taken: one with Line 1 connected to Analyzer / Receiver and Line 2 connected to a 50 ohm load; the second scan had Line 1 connected to a 50 ohm load and Line 2 connected to the Analyzer / Receiver.
- 7 Analyzer / Receiver scanned from 150 KHz to 30MHz for emissions in each of the test modes.
- 8 During the above scans, the emissions were maximized by cable manipulation.

AC Power Conducted Emission Limit

For intentional device, according to § 15.207(a) AC Power Conducted Emission Limits is as following :

Frequency range (MHz)	Limit (dBuV)	
	Quasi-peak	Average
0.15-0.5	66 to 56*	56 to 46*
0.5-5	56	46
5-30	60	50

* Decreases with the logarithm of the frequency.

DISTURBANCE Calculation

The AC mains conducted disturbance is calculated by adding the 10dB Pulse Limiter and Cable Factor and Duty Cycle Correction Factor (if any) from the measured reading. The basic equation with a sample calculation is as follows:

$$CD \text{ (dBuV)} = RA \text{ (dBuV)} + PL \text{ (dB)} + CL \text{ (dB)}$$

Where CD = Conducted Disturbance	CL = Cable Attenuation Factor (Cable Loss)
RA = Reading Amplitude	PL = 10 dB Pulse Limiter Factor

TEST RESULTS

Remark: We measured Conducted Emission at all mode in AC 120V/60Hz, the worst case was recorded .

Temperature	25°C	Humidity	60%
Test Engineer	Evan Ouyang	Configurations	IEEE 802.11ac20 HCH

Power supply:	AC 120V/60Hz	Polarization	L
---------------	--------------	--------------	---

Test Graph

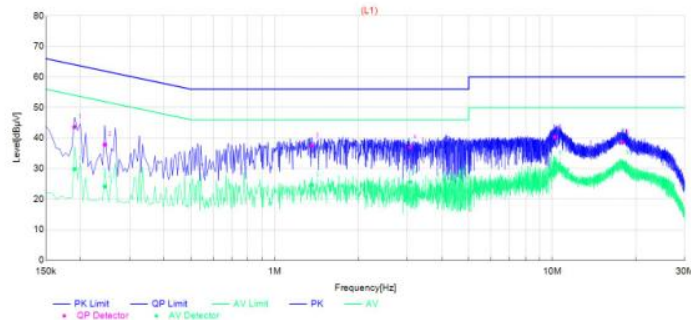

Final Data List

NO.	Frequency	QP	AVG.	Factor	QP	AVG.	QP	AVG.	QP	AVG.	Line	Remark
		Reading	Reading		Result	Result	Limit	Limit	Margin	Margin		
1	0.1902	33.49	19.69	10.16	43.65	29.85	64.03	54.03	20.38	24.18	L1	PASS
2	0.2446	27.72	14.03	10.12	37.84	24.15	61.94	51.94	24.10	27.79	L1	PASS
3	1.3610	27.17	14.44	10.23	37.40	24.67	56.00	46.00	18.60	21.33	L1	PASS
4	3.0647	26.67	15.24	10.34	37.01	25.58	56.00	46.00	18.99	20.42	L1	PASS
5	10.2077	29.75	21.13	10.61	40.36	31.74	60.00	50.00	19.64	18.26	L1	PASS
6	17.9079	27.20	20.52	11.31	38.51	31.83	60.00	50.00	21.49	18.17	L1	PASS

Note:1. Result (dBµV) = Reading (dBµV) + Factor (dB).

2. Factor (dB) = Cable loss (dB) + LISN Factor (dB).

Power supply:	AC 120V/60Hz	Polarization	N
---------------	--------------	--------------	---

Test Graph

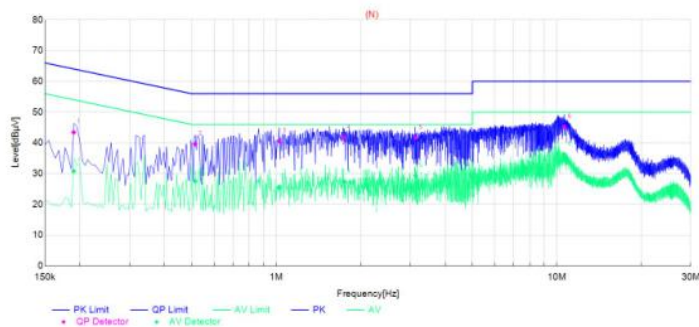

Final Data List

NO.	Frequency	QP	AVG.	Factor	QP	AVG.	QP	AVG.	QP	AVG.	Line	Remark
		Reading	Reading		Result	Result	Limit	Limit	Margin	Margin		
1	0.1898	33.27	20.67	10.16	43.43	30.83	64.04	54.04	20.61	23.21	N	PASS
2	0.5137	29.38	17.32	10.24	39.62	27.56	56.00	46.00	16.38	18.44	N	PASS
3	1.0227	30.44	15.39	10.20	40.64	25.59	56.00	46.00	15.36	20.41	N	PASS
4	1.7349	31.45	17.25	10.25	41.70	27.50	56.00	46.00	14.30	18.50	N	PASS
5	3.1338	31.34	19.00	10.35	41.69	29.35	56.00	46.00	14.31	16.65	N	PASS
6	10.6192	34.59	25.61	10.67	45.26	36.28	60.00	50.00	14.74	13.72	N	PASS

Note:1. Result (dBµV) = Reading (dBµV) + Factor (dB).

2. Factor (dB) = Cable loss (dB) + LISN Factor (dB).

4.2. Radiated Emission

TEST CONFIGURATION

Frequency range 9 KHz – 30MHz

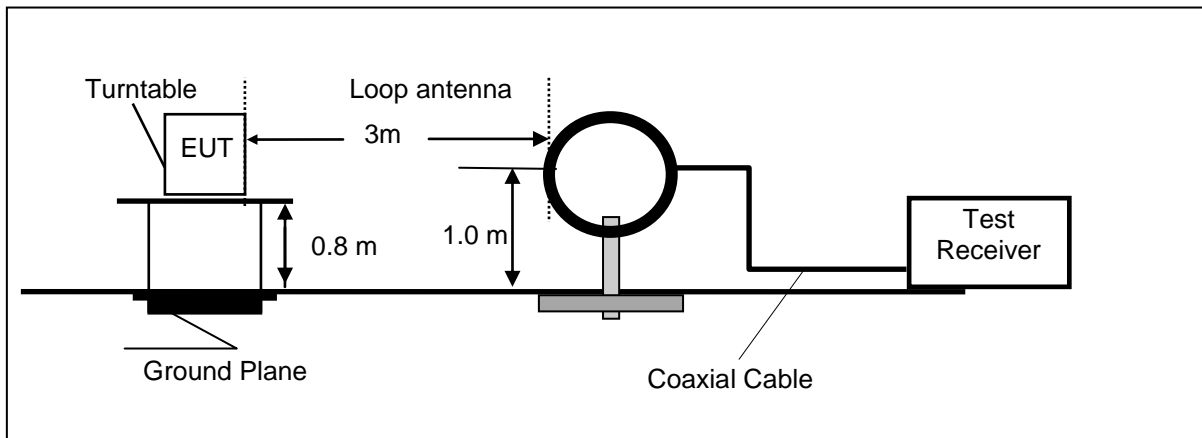

Frequency range 30MHz – 1000MHz

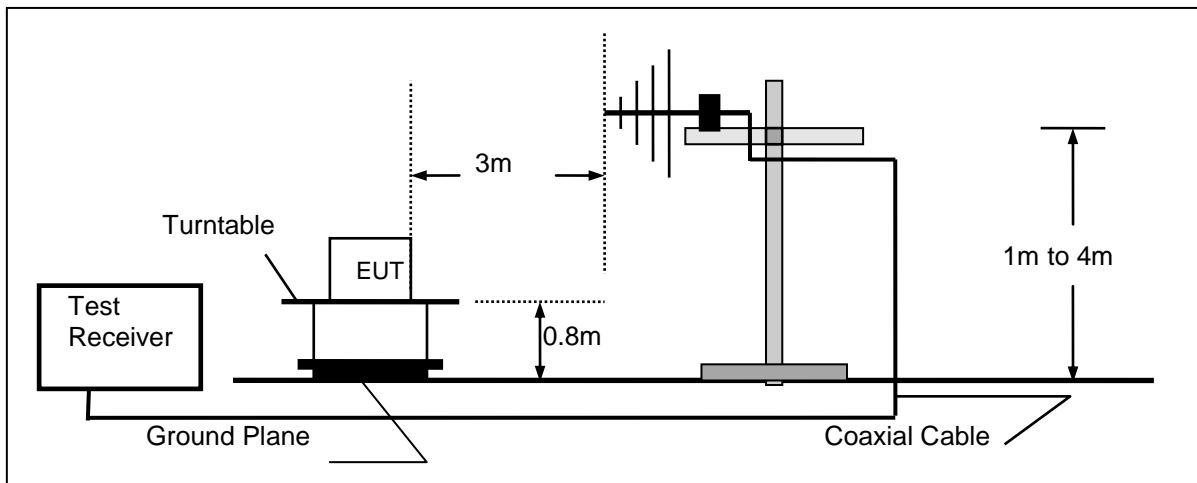

Frequency range above 1GHz

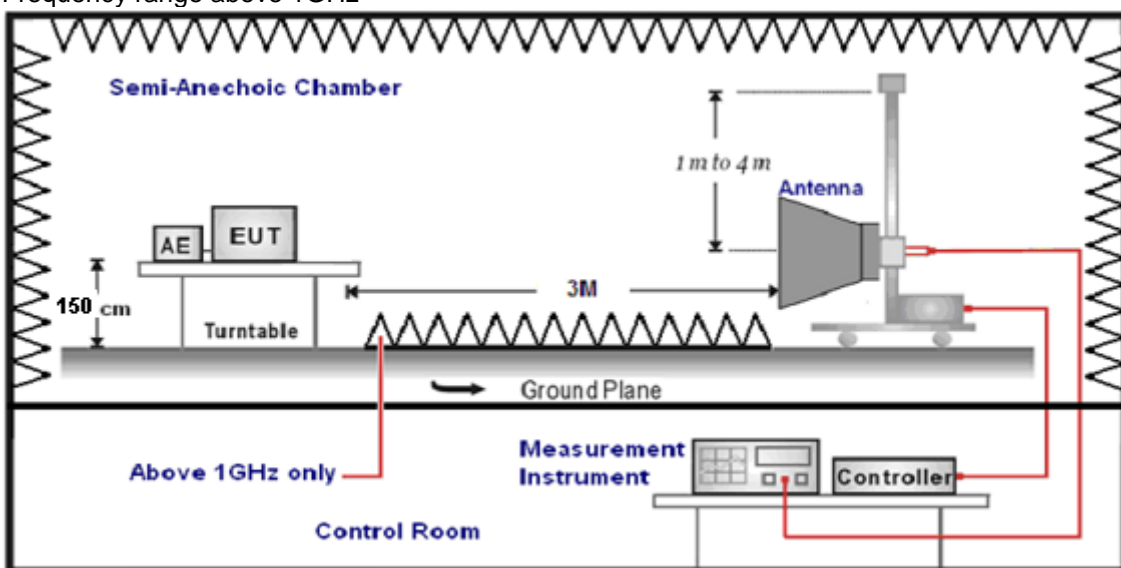

TEST PROCEDURE

1. The EUT was placed on a turn table which is 0.8m above ground plane when testing frequency range 9 KHz –1GHz;the EUT was placed on a turn table which is 1.5m above ground plane when testing above 1GHz.
2. Maximum procedure was performed by raising the receiving antenna from 1m to 4m and rotating the turn table from 0° to 360° to acquire the highest emissions from EUT.
3. And also, each emission was to be maximized by changing the polarization of receiving antenna both horizontal and vertical.
4. Repeat above procedures until all frequency measurements have been completed.
5. The EUT minimum operation frequency was 24MHz and maximum operation frequency was 5825MHz.so radiated emission test frequency band from 9KHz to 40GHz.
6. The distance between test antenna and EUT as following table states:

Test Frequency range	Test Antenna Type	Test Distance
9KHz-30MHz	Active Loop Antenna	3
30MHz-1GHz	Ultra-Broadband Antenna	3
1GHz-18GHz	Double Ridged Horn Antenna	3
18GHz-25GHz	Horn Antenna	1

7. Setting test receiver/spectrum as following table states:

Test Frequency range	Test Receiver/Spectrum Setting	Detector
9KHz-150KHz	RBW=200Hz/VBW=3KHz, Sweep time=Auto	QP
150KHz-30MHz	RBW=9KHz/VBW=100KHz, Sweep time=Auto	QP
30MHz-1GHz	RBW=120KHz/VBW=1000KHz, Sweep time=Auto	QP
1GHz-40GHz	Peak Value: RBW=1MHz/VBW=3MHz, Sweep time=Auto Average Value: RBW=1MHz/VBW=10Hz, Sweep time=Auto	Peak

Field Strength Calculation

The field strength is calculated by adding the Antenna Factor and Cable Factor and subtracting the Amplifier Gain and Duty Cycle Correction Factor(if any) from the measured reading. The basic equation with a sample calculation is as follows:

FS = RA + AF + CL - AG

Where FS = Field Strength	CL = Cable Attenuation Factor (Cable Loss)
RA = Reading Amplitude	AG = Amplifier Gain
AF = Antenna Factor	

Transd=AF +CL-AG

RADIATION LIMIT

According to §15.407 (b): Except as shown in paragraph (b)(7) of this section, the maximum emissions outside of the frequency bands of operation shall be attenuated in accordance with the following limits

Frequency (MHz)	EIRP Limit (dBm)	Equivalent Field Strength at 3m (dBµV/m)
5150-5250	-27	68.2
5250-5350	-27	68.2
5470-5725	-27	68.2
5725-5850	-27 (beyond 10MHz of the bandedge)	68.2
	-17 (within 10 MHz of band edge)	78.2

Frequency (MHz)	Distance (Meters)	Radiated (dBµV/m)	Radiated (µV/m)
0.009-0.49	3	$20\log(2400/F(KHz))+40\log(300/3)$	2400/F(KHz)
0.49-1.705	3	$20\log(24000/F(KHz))+ 40\log(30/3)$	24000/F(KHz)
1.705-30	3	$20\log(30)+ 40\log(30/3)$	30
30-88	3	40.0	100
88-216	3	43.5	150
216-960	3	46.0	200
Above 960	3	54.0	500

TEST RESULTS

Remark: We measured Radiated Emission at all mode from 9KHz to 25GHz in AC 120V/60Hz and the worst case was recorded.

Temperature	23.4°C	Humidity	54.5%
Test Engineer	Evan Ouyang	Configurations	IEEE 802.11ac20 HCH

For 9 KHz~30MHz

Freq. (MHz)	Level (dBuV)	Over Limit (dB)	Over Limit (dBuV)	Remark
-	-	-	-	See Note

Note:

The amplitude of spurious emissions which are attenuated by more than 20 dB below the permissible value has no need to be reported.

Distance extrapolation factor = $40 \log(\text{specific distance} / \text{test distance})$ (dB);

Limit line = specific limits (dBuV) + distance extrapolation factor.

For 30MHz-1GHz

Horizontal

Test Graph

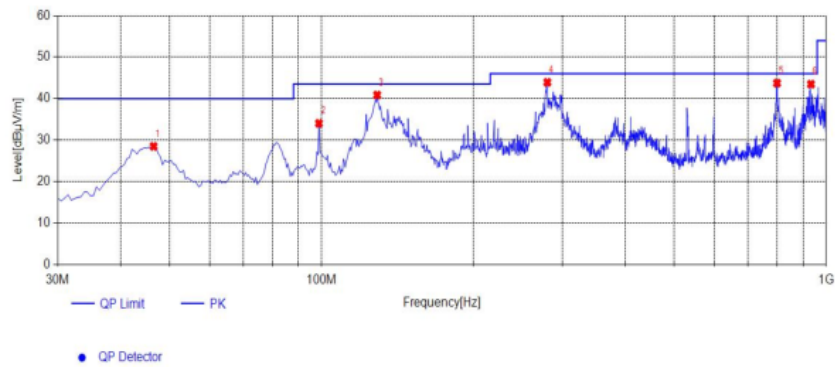

Suspected List

NO.	Frequency [MHz]	Reading [dBµV/m]	Factor [dB]	Result [dBµV/m]	Limit [dBµV/m]	Margin [dB]	Height [cm]	Angle [°]	Detector	Polarity	Remark
1	46.49	39.76	-11.28	28.48	40.00	11.52	100	268	PK	Horizontal	PASS
2	98.87	45.90	-11.87	34.03	43.50	9.47	100	2	PK	Horizontal	PASS
3	128.94	54.37	-13.50	40.87	43.50	2.63	100	105	PK	Horizontal	PASS
4	280.26	51.71	-7.78	43.93	46.00	2.07	100	182	PK	Horizontal	PASS
5	799.21	42.28	1.46	43.74	46.00	2.26	100	52	PK	Horizontal	PASS
6	933.07	41.13	2.35	43.48	46.00	2.52	100	344	PK	Horizontal	PASS

Note:1. Result (dBµV/m) = Reading(dBµV/m) + Factor (dB) .

2. Factor (dB) = Antenna Factor (dB/m) + Cable loss (dB) - Pre Amplifier gain (dB).

Vertical

Test Graph

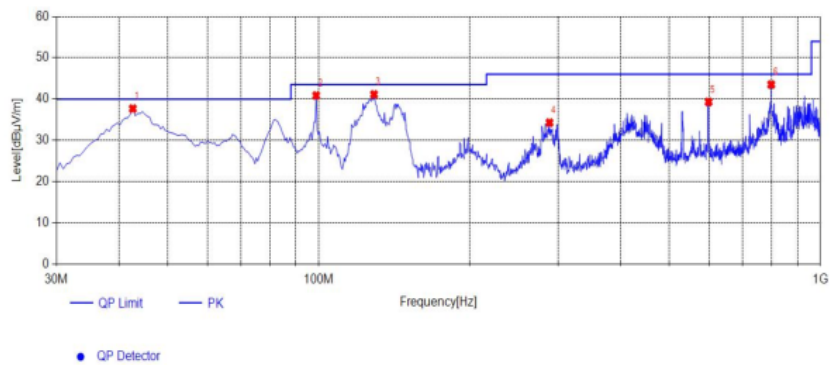

Suspected List

NO.	Frequency [MHz]	Reading [dBµV/m]	Factor [dB]	Result [dBµV/m]	Limit [dBµV/m]	Margin [dB]	Height [cm]	Angle [°]	Detector	Polarity	Remark
1	42.61	49.25	-11.56	37.69	40.00	2.31	100	101	PK	Vertical	PASS
2	98.87	52.74	-11.87	40.87	43.50	2.63	100	29	PK	Vertical	PASS
3	128.94	54.62	-13.50	41.12	43.50	2.38	100	101	PK	Vertical	PASS
4	288.505	41.97	-7.68	34.29	46.00	11.71	100	161	PK	Vertical	PASS
5	598.905	39.87	-0.56	39.31	46.00	6.69	100	171	PK	Vertical	PASS
6	798.24	42.06	1.46	43.52	46.00	2.48	100	38	PK	Vertical	PASS

Note:1. Result (dBµV/m) = Reading(dBµV/m) + Factor (dB) .

2. Factor (dB) = Antenna Factor (dB/m) + Cable loss (dB) - Pre Amplifier gain (dB).

For 1GHz to 40GHz
5150-5250MHz:

IEEE 802.11ac HT20_ANT 1(Worst Case)
802.11ac20 Mode_Channel 36_ 5180 MHz

Item (Mark)	Freq (MHz)	Read Level (dBµV)	Antenna Factor (dB/m)	PRM Factor dB	Cable Loss (dB)	Result Level (dBµV/m)	Limit Line (dBµV/m)	Margin (dB)	Detector	Polarization
1	10360	39.58	38.55	33.13	11.26	56.26	68.20	-11.94	Peak	Horizontal
1	10360	31.68	38.55	33.13	11.26	48.36	54.00	-5.64	AV	Horizontal
1	10360	40.76	38.55	33.13	11.26	57.44	68.20	-10.76	Peak	Vertical
1	10360	29.15	38.55	33.13	11.26	45.83	54.00	-8.17	AV	Vertical

802.11ac20 Mode_Channel 40_ 5200 MHz

Item (Mark)	Freq (MHz)	Read Level (dBµV)	Antenna Factor (dB/m)	PRM Factor dB	Cable Loss (dB)	Result Level (dBµV/m)	Limit Line (dBµV/m)	Margin (dB)	Detector	Polarization
1	10400	39.89	38.55	33.13	11.26	56.57	68.20	-11.63	Peak	Horizontal
1	10400	30.66	38.55	33.13	11.26	47.34	54.00	-6.66	AV	Horizontal
1	10400	40.84	38.55	33.13	11.26	57.52	68.20	-10.68	Peak	Vertical
1	10400	29.53	38.55	33.13	11.26	46.21	54.00	-7.79	AV	Vertical

802.11ac20 Mode_Channel 48_ 5240 MHz

Item (Mark)	Freq (MHz)	Read Level (dBµV)	Antenna Factor (dB/m)	PRM Factor dB	Cable Loss (dB)	Result Level (dBµV/m)	Limit Line (dBµV/m)	Margin (dB)	Detector	Polarization
1	10480	40.10	38.55	33.13	11.26	56.78	68.20	-11.42	Peak	Horizontal
1	10480	30.07	38.55	33.13	11.26	46.75	54.00	-7.25	AV	Horizontal
1	10480	41.77	38.55	33.13	11.26	58.45	68.20	-9.75	Peak	Vertical
1	10480	29.20	38.55	33.13	11.26	45.88	54.00	-8.12	AV	Vertical

IEEE 802.11ax HT20_ANT 1(Worst Case)
802.11ax20 Mode_Channel 36_ 5180 MHz

Item (Mark)	Freq (MHz)	Read Level (dBµV)	Antenna Factor (dB/m)	PRM Factor dB	Cable Loss (dB)	Result Level (dBµV/m)	Limit Line (dBµV/m)	Margin (dB)	Detector	Polarization
1	10360	39.60	38.55	33.13	11.26	56.28	68.20	-11.92	Peak	Horizontal
1	10360	30.88	38.55	33.13	11.26	47.56	54.00	-6.44	AV	Horizontal
1	10360	40.82	38.55	33.13	11.26	57.50	68.20	-10.70	Peak	Vertical
1	10360	29.27	38.55	33.13	11.26	45.95	54.00	-8.05	AV	Vertical

802.11ax20 Mode_Channel 40_ 5200 MHz

Item (Mark)	Freq (MHz)	Read Level (dBµV)	Antenna Factor (dB/m)	PRM Factor dB	Cable Loss (dB)	Result Level (dBµV/m)	Limit Line (dBµV/m)	Margin (dB)	Detector	Polarization
1	10400	39.15	38.55	33.13	11.26	55.83	68.20	-12.37	Peak	Horizontal
1	10400	31.92	38.55	33.13	11.26	48.60	54.00	-5.40	AV	Horizontal
1	10400	40.65	38.55	33.13	11.26	57.33	68.20	-10.87	Peak	Vertical
1	10400	28.28	38.55	33.13	11.26	44.96	54.00	-9.04	AV	Vertical

802.11ax20 Mode_Channel 48_ 5240 MHz

Item (Mark)	Freq (MHz)	Read Level (dBµV)	Antenna Factor (dB/m)	PRM Factor dB	Cable Loss (dB)	Result Level (dBµV/m)	Limit Line (dBµV/m)	Margin (dB)	Detector	Polarization
1	10480	40.38	38.55	33.13	11.26	57.06	68.20	-11.14	Peak	Horizontal
1	10480	30.43	38.55	33.13	11.26	47.11	54.00	-6.89	AV	Horizontal
1	10480	40.47	38.55	33.13	11.26	57.15	68.20	-11.05	Peak	Vertical
1	10480	28.51	38.55	33.13	11.26	45.19	54.00	-8.81	AV	Vertical

5725-5850MHz:

IEEE 802.11ac HT20_ANT 1(Worst Case)
802.11ac20 Mode_Channel 149_ 5745 MHz

Item (Mark)	Freq (MHz)	Read Level (dBµV)	Antenna Factor (dB/m)	PRM Factor dB	Cable Loss (dB)	Result Level (dBµV/m)	Limit Line (dBµV/m)	Margin (dB)	Detector	Polarization
1	11490	40.32	38.55	33.13	11.26	57.00	68.20	-11.20	Peak	Horizontal
1	11490	30.18	38.55	33.13	11.26	46.86	54.00	-7.14	AV	Horizontal
1	11490	41.22	38.55	33.13	11.26	57.90	68.20	-10.30	Peak	Vertical
1	11490	29.83	38.55	33.13	11.26	46.51	54.00	-7.49	AV	Vertical

802.11ac20 Mode_Channel 157_ 5785 MHz

Item (Mark)	Freq (MHz)	Read Level (dBµV)	Antenna Factor (dB/m)	PRM Factor dB	Cable Loss (dB)	Result Level (dBµV/m)	Limit Line (dBµV/m)	Margin (dB)	Detector	Polarization
1	11570	39.62	38.55	33.13	11.26	56.30	68.20	-11.90	Peak	Horizontal
1	11570	30.15	38.55	33.13	11.26	46.83	54.00	-7.17	AV	Horizontal
1	11570	40.32	38.55	33.13	11.26	57.00	68.20	-11.20	Peak	Vertical
1	11570	28.11	38.55	33.13	11.26	44.79	54.00	-9.21	AV	Vertical

802.11ac20 Mode_Channel 165_ 5825 MHz

Item (Mark)	Freq (MHz)	Read Level (dBµV)	Antenna Factor (dB/m)	PRM Factor dB	Cable Loss (dB)	Result Level (dBµV/m)	Limit Line (dBµV/m)	Margin (dB)	Detector	Polarization
1	11650	40.01	38.55	33.13	11.26	56.69	68.20	-11.51	Peak	Horizontal
1	11650	30.37	38.55	33.13	11.26	47.05	54.00	-6.95	AV	Horizontal
1	11650	40.42	38.55	33.13	11.26	57.10	68.20	-11.10	Peak	Vertical
1	11650	29.12	38.55	33.13	11.26	45.80	54.00	-8.20	AV	Vertical

IEEE 802.11ax HT20_ANT 1(Worst Case)
802.11ax20 Mode_Channel 149_ 5745 MHz

Item (Mark)	Freq (MHz)	Read Level (dBµV)	Antenna Factor (dB/m)	PRM Factor dB	Cable Loss (dB)	Result Level (dBµV/m)	Limit Line (dBµV/m)	Margin (dB)	Detector	Polarization
1	11490	39.14	38.55	33.13	11.26	55.82	68.20	-12.38	Peak	Horizontal
1	11490	31.36	38.55	33.13	11.26	48.04	54.00	-5.96	AV	Horizontal
1	11490	41.23	38.55	33.13	11.26	57.91	68.20	-10.29	Peak	Vertical
1	11490	28.84	38.55	33.13	11.26	45.52	54.00	-8.48	AV	Vertical

802.11ax20 Mode_Channel 157_ 5785 MHz

Item (Mark)	Freq (MHz)	Read Level (dBµV)	Antenna Factor (dB/m)	PRM Factor dB	Cable Loss (dB)	Result Level (dBµV/m)	Limit Line (dBµV/m)	Margin (dB)	Detector	Polarization
1	11570	40.44	38.55	33.13	11.26	57.12	68.20	-11.08	Peak	Horizontal
1	11570	30.96	38.55	33.13	11.26	47.64	54.00	-6.36	AV	Horizontal
1	11570	40.58	38.55	33.13	11.26	57.26	68.20	-10.94	Peak	Vertical
1	11570	28.75	38.55	33.13	11.26	45.43	54.00	-8.57	AV	Vertical

802.11ax20 Mode_Channel 165_ 5825 MHz

Item (Mark)	Freq (MHz)	Read Level (dBµV)	Antenna Factor (dB/m)	PRM Factor dB	Cable Loss (dB)	Result Level (dBµV/m)	Limit Line (dBµV/m)	Margin (dB)	Detector	Polarization
1	11650	40.86	38.55	33.13	11.26	57.54	68.20	-10.66	Peak	Horizontal
1	11650	30.03	38.55	33.13	11.26	46.71	54.00	-7.29	AV	Horizontal
1	11650	41.51	38.55	33.13	11.26	58.19	68.20	-10.01	Peak	Vertical
1	11650	29.66	38.55	33.13	11.26	46.34	54.00	-7.66	AV	Vertical

REMARKS:

1. Result Level = Read Level + Antenna Factor + Cable loss - PRM Factor.
2. Margin = Result Level - Limit
3. The other emission levels were very low against the limit.
4. Detector AV is setting spectrum/receiver. RBW=1MHz/VBW=10Hz/Sweep time=Auto/Detector=Peak;

NOTE: All the modes have been tested and recorded worst mode in the report.

4.3. Duty Cycle

TEST CONFIGURATION

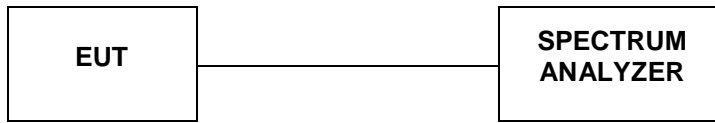

TEST PROCEDURE

According to KDB789033 D02 General U-NII Test Procedures New Rules v02r01 Duty Cycle (x), Transmission Duration (T):

- a. A diode detector and an oscilloscope that together have sufficiently short response time to permit accurate measurements of the on and off times of the transmitted signal
- b. The zero-span mode on a spectrum analyzer or EMI receiver, if the response time and spacing between bins on the sweep are sufficient to permit accurate measurements of the on and off times of the transmitted signal. Set the center frequency of the instrument to the center frequency of the transmission. Set $RBW \geq EBW$ if possible; otherwise, set RBW to the largest available value. Set $VBW \geq RBW$. Set detector = peak or average. The zerospan measurement method shall not be used unless both RBW and VBW are $> 50/T$, where T is defined in section II.B.1.a), and the number of sweep points across duration T exceeds 100. (For example, if VBW and/or RBW are limited to 3 MHz, then the zero-span method of measuring duty cycle shall not be used if $T \leq 16.7$ microseconds.)

TEST RESULTS

For reporting purpose only.

Antenna 1:

Please refer to Appendix D-ANT 1-Appendix D.3.

Please refer to Appendix E-ANT 1-Appendix E.3.

Antenna 2:

Please refer to Appendix D-ANT 2-Appendix D.3.

Please refer to Appendix E-ANT 2-Appendix E.3.

4.4. Maximum Average Output Power

TEST CONFIGURATION

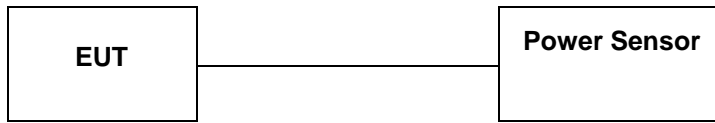

TEST PROCEDURE

According to KDB789033 D02 General U-NII Test Procedures New Rules v02r01 Measurement using a Power Meter (PM):

- a. Measurements may be performed using a wideband RF power meter with a thermocouple detector or equivalent if all of the conditions listed below are satisfied
 - 1. The EUT is configured to transmit continuously or to transmit with a constant duty cycle
 - 2. At all times when the EUT is transmitting, it must be transmitting at its maximum power control level.
 - 3. The integration period of the power meter exceeds the repetition period of the transmitted signal by at least a factor of five.
- b. If the transmitter does not transmit continuously, measure the duty cycle, x, of the transmitter output signal as described in section II.B
- c. Measure the average power of the transmitter. This measurement is an average over both the on and off periods of the transmitter.

Adjust the measurement in dBm by adding $10 \log(1/x)$ where x is the duty cycle (e.g., $10 \log(1/0.25)$ if the duty cycle is 25 percent).

LIMIT

According to §15.407(a): The maximum output power should be not exceed follow:

Frequency Range (MHz)	Limit
5150-5250	Fixed: 1 Watt (30dBm) Mobile and portable: 250mW (24dBm)
5250-5350	250mW (24dBm)
5470-5725	250mW (24dBm)
5725-5850	1 Watt (30dBm)

Note: The maximum e.i.r.p at any elevation angle above 30 degrees as measured from the horizon must not exceed 125mW(21dBm)

TEST RESULTS

For reporting purpose only.

Antenna 1:

Please refer to Appendix D-ANT 1-Appendix D.4.

Please refer to Appendix E-ANT 1-Appendix E.4.

Antenna 2:

Please refer to Appendix D-ANT 2-Appendix D.4.

Please refer to Appendix E-ANT 2-Appendix E.4.

MIMO*2
5150-5250MHz:

Type	Channel	Power (dBm) ANT1	Power (dBm) ANT2	Total (dBm)	Limit (dBm)	Result
802.11n HT20	36	12.48	12.40	15.45	24.00	Pass
	40	12.44	12.21	15.34		
	48	11.72	11.25	14.50		
802.11n HT40	38	12.35	12.19	15.28	24.00	Pass
	46	11.95	11.39	14.69		
802.11ac20	36	12.38	12.36	15.38	24.00	Pass
	40	12.38	12.31	15.36		
	48	11.71	11.40	14.57		
802.11ac40	38	12.41	12.23	15.33	24.00	Pass
	46	11.93	11.42	14.69		
802.11ac80	42	11.98	11.64	14.82	24.00	Pass
802.11ax20	36	11.25	11.34	14.31	24.00	Pass
	40	10.99	11.04	14.03		
	48	11.47	10.09	13.84		
802.11ax40	38	12.24	11.02	14.68	24.00	Pass
	46	11.50	10.31	13.96		
802.11ax80	42	11.82	10.73	14.32	24.00	Pass

5745-5825MHz:

Type	Channel	Power (dBm) ANT1	Power (dBm) ANT2	Total (dBm)	Limit (dBm)	Result
802.11n HT20	149	11.78	11.08	14.45	30.00	Pass
	157	12.41	11.62	15.04		
	165	11.97	11.30	14.66		
802.11n HT40	151	11.86	11.05	14.48	30.00	Pass
	159	12.27	11.54	14.93		
802.11ac20	149	11.84	11.15	14.52	30.00	Pass
	157	12.41	11.67	15.07		
	165	11.98	11.36	14.69		
802.11ac40	151	11.94	11.06	14.53	30.00	Pass
	159	12.30	11.51	14.93		
802.11ac80	155	11.53	10.73	14.16	30.00	Pass
802.11ax20	149	11.87	11.08	14.50	30.00	Pass
	157	12.32	11.58	14.98		
	165	11.93	11.32	14.65		
802.11ax40	151	11.79	10.97	14.41	30.00	Pass
	159	12.36	11.45	14.94		
802.11ax80	155	11.59	10.94	14.29	30.00	Pass

Remark:

The Directional Gain= Gain of individual transmit antennas (dBi) + Array gain;

Array gain = $10 \log(N_{ant})$, where N_{ant} is the number of transmit antennas

Directional Gain=5.01 dBi

MIMO Limit (dBm)= Limit (dBm)-(Directional Gain-6dBi)

4.5. Power Spectral Density

TEST CONFIGURATION

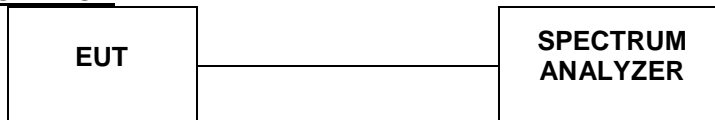

TEST PROCEDURE

According to KDB789033 D02 General U-NII Test Procedures New Rules v02r01: The rules requires “maximum power spectral density” measurements where the intent is to measure the maximum value of the time average of the power spectral density measured during a period of continuous transmission

- a. Create an average power spectrum for the EUT operating mode being tested by following the instructions in section II.E.2. for measuring maximum conducted output power using a spectrum analyzer or EMI receiver: select the appropriate test method (SA-1, SA-2, SA-3, or alternatives to each) and apply it up to, but not including, the step labeled, “Compute power...”. (This procedure is required even if the maximum conducted output power measurement was performed using a power meter, method PM.)
- b. Use the peak search function on the instrument to find the peak of the spectrum and record its value.
- c. Make the following adjustments to the peak value of the spectrum, if applicable:
 1. If Method SA-2 or SA-2 Alternative was used, add $10 \log(1/x)$, where x is the duty cycle, to the peak of the spectrum.
 2.) If Method SA-3 Alternative was used and the linear mode was used in step II.E.2.g)(viii), add 1 dB to the final result to compensate for the difference between linear averaging and power averaging.
- d. The result is the Maximum PSD over 1 MHz reference bandwidth.
- e. For devices operating in the bands 5.15-5.25 GHz, 5.25-5.35 GHz, and 5.47-5.725 GHz, the above procedures make use of 1 MHz RBW to satisfy directly the 1 MHz reference bandwidth specified in § 15.407(a)(5). For devices operating in the band 5.725-5.85 GHz, the rules specify a measurement bandwidth of 500 kHz. Many spectrum analyzers do not have 500 kHz RBW, thus a narrower RBW may need to be used. The rules permit the use of a RBWs less than 1 MHz, or 500 kHz, “provided that the measured power is integrated over the full reference bandwidth” to show the total power over the specified measurement bandwidth (i.e., 1 MHz, or 500 kHz). If measurements are performed using a reduced resolution bandwidth (< 1 MHz, or < 500 kHz) and integrated over 1 MHz, or 500 KHz bandwidth, the following adjustments to the procedures apply:
 1. Set $RBW \geq 1/T$, where T is defined in section II.B.I.a).
 2. Set $VBW \geq 3 RBW$.
 3. If measurement bandwidth of Maximum PSD is specified in 500 kHz, add $10\log(500kHz/RBW)$ to the measured result, whereas RBW (< 500 KHz) is the reduced resolution bandwidth of the spectrum analyzer set during measurement.
 4. If measurement bandwidth of Maximum PSD is specified in 1 MHz, add $10\log(1MHz/RBW)$ to the measured result, whereas RBW (< 1 MHz) is the reduced resolution bandwidth of spectrum analyzer set during measurement.
 5. Care must be taken to ensure that the measurements are performed during a period of continuous transmission or are corrected upward for duty cycle.

Note: As a practical matter, it is recommended to use reduced RBW of 100 KHz for the sections 5.c) and 5.d) above, since RBW=100 KHz is available on nearly all spectrum analyzers.
- f. Adjust the measurement in dBm by adding $10 \log(1/x)$ where x is the duty cycle (e.g., $10 \log(1/0.25)$ if the duty cycle is 25 percent).

LIMIT

According to §15.407(a): The maximum output power should be not exceed follow:

Frequency Range (MHz)	Limit
5150-5250	Other then Mobile and portable:17dBm/MHz Mobile and portable:11dBm/MHz
5250-5350	11dBm/MHz
5470-5725	11dBm/MHz
5725-5850	30dBm/500kHz

TEST RESULTS

For reporting purpose only.

Antenna 1:

Please refer to Appendix D-ANT 1-Appendix D.5.

Please refer to Appendix E-ANT 1-Appendix E.5.

Antenna 2:

Please refer to Appendix D-ANT 2-Appendix D.5.

Please refer to Appendix E-ANT 2-Appendix E.5.

MIMO*2**5150-5250MHz:**

Type	Channel	PSD (dBm/1MHz) ANT1	PSD (dBm/1MHz) ANT2	Total (dBm/1MHz)	Limit (dBm/1MHz)	Result
802.11n HT20	36	0.48	0.49	3.50	11.00	Pass
	40	0.49	0.32	3.42		
	48	-0.07	-0.53	2.72		
802.11n HT40	38	-2.57	-2.69	0.38	11.00	Pass
	46	-2.77	-3.28	-0.01		
802.11ac 20	36	0.40	0.43	3.43	11.00	Pass
	40	0.43	0.50	3.48		
	48	-0.08	-0.35	2.80		
802.11ac 40	38	-2.54	-2.62	0.43	11.00	Pass
	46	-2.83	-3.26	-0.03		
802.11ac 80	42	-5.28	-5.26	-2.26	11.00	Pass
802.11ax 20	36	-1.22	-1.02	1.89	11.00	Pass
	40	-1.43	-1.15	1.72		
	48	-0.85	-1.98	1.63		
802.11ax 40	38	-2.88	-4.08	-0.43	11.00	Pass
	46	-3.43	-4.58	-0.96		
802.11ax 80	42	-5.70	-6.52	-3.08	11.00	Pass

5725-5850MHz:

Type	Channel	PSD (dBm/500KHz) ANT1	PSD (dBm/500KHz) ANT2	Total (dBm/500KHz)	Limit (dBm/500KHz)	Result
802.11 n HT20	149	-2.12	-2.83	0.55	30.00	Pass
	157	-1.62	-2.49	0.98		
	165	-2.05	-2.77	0.62		
802.11 n HT40	151	-5.26	-6.06	-2.63	30.00	Pass
	159	-4.79	-5.49	-2.12		
802.11 ac20	149	-2.01	-2.86	0.60	30.00	Pass
	157	-1.71	-2.37	0.98		
	165	-1.99	-2.74	0.66		
802.11 ac40	151	-5.28	-5.99	-2.61	30.00	Pass
	159	-4.70	-5.50	-2.07		
802.11 ac80	155	-8.23	-8.45	-5.33	30.00	Pass
802.11 ax20	149	-3.31	-4.19	-0.72	30.00	Pass
	157	-2.75	-3.75	-0.21		
	165	-3.18	-4.04	-0.58		
802.11 ax40	151	-6.29	-7.10	-3.67	30.00	Pass
	159	-5.59	-6.49	-3.01		
802.11 ax80	155	-8.96	-9.23	-6.08	30.00	Pass

Remark:

The Directional Gain= Gain of individual transmit antennas (dBi) + Array gain;

Array gain = $10 \log(N_{ant})$, where N_{ant} is the number of transmit antennas

Directional Gain=5.01dBi

MIMO Limit (dBm)= Limit (dBm)-(Directional Gain-6dBi)

4.6. 99% and 6dB Bandwidth

TEST CONFIGURATION

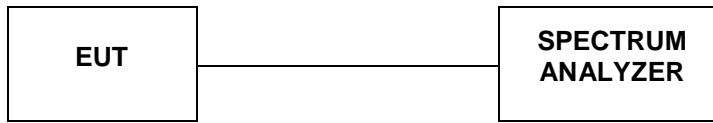

TEST PROCEDURE

According to KDB789033 D02 General U-NII Test Procedures New Rules v02r01 for one of the following procedures may be used for section 15.407(e) specifies the minimum 6 dB emission bandwidth of at least 500 KHz for the band 5.715-5.85 GHz. The following procedure shall be used for measuring this bandwidth:

- a. Set RBW = 100 kHz.
- b. Set the video bandwidth (VBW) $\geq 3 \times$ RBW
- c. Detector = Peak.
- d. Trace mode = max hold.
- e. Sweep = auto couple.
- f. Allow the trace to stabilize
- g. Measure the maximum width of the emission that is constrained by the frequencies associated with the two outermost amplitude points (upper and lower frequencies) that are attenuated by 6 dB relative to the maximum level measured in the fundamental emission.

Note: The automatic bandwidth measurement capability of a spectrum analyzer or EMI receiver may be employed if it implements the functionality described above.

LIMIT

For Section 15.407(e) specifies the minimum 6 dB emission bandwidth of at least 500 KHz for the band 5.715-5.85 GHz

TEST RESULTS

For reporting purpose only.

Antenna 1:

Please refer to Appendix E-ANT 1-Appendix E.1.

Please refer to Appendix E-ANT 1-Appendix E.2.

Antenna 2:

Please refer to Appendix E-ANT 2-Appendix E.1.

Please refer to Appendix E-ANT 2-Appendix E.2.

4.7. 99% and 26dBc Bandwidth

TEST CONFIGURATION

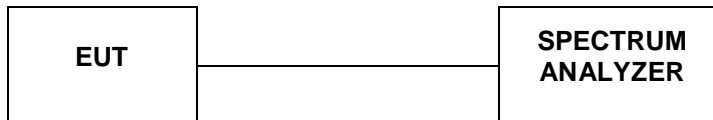

TEST PROCEDURE

According to KDB789033 D02 General U-NII Test Procedures New Rules v02r01 for one of the following procedures may be used for Emission Bandwidth (EBW) measurement:

- a. Set RBW = 220 kHz/430 kHz /820 kHz (approximately 1% of the emission bandwidth).
- b. Set the video bandwidth (VBW) = 3* RBW)
- c. Detector = Peak.
- d. Trace mode = max hold.
- e. Sweep = auto couple.
- f. Allow the trace to stabilize
- g. Measure the maximum width of the emission that is 26 dB down from the maximum of the emission. Compare this with the RBW setting of the analyzer. Readjust RBW and repeat measurement as needed until the RBW/EBW ratio is approximately 1%.

Note: The automatic bandwidth measurement capability of a spectrum analyzer or EMI receiver may be employed if it implements the functionality described above.

LIMIT

No Limits for 26dBc Bandwidth

TEST RESULTS

For reporting purpose only.

Antenna 1:

Please refer to Appendix D-ANT 1-Appendix D.1.

Please refer to Appendix D-ANT 1-Appendix D.2.

Antenna 2:

Please refer to Appendix D-ANT 2-Appendix D.1.

Please refer to Appendix D-ANT 2-Appendix D.2.

4.8. Conducted Spurious Emissions and Band Edge Compliance

TEST CONFIGURATION

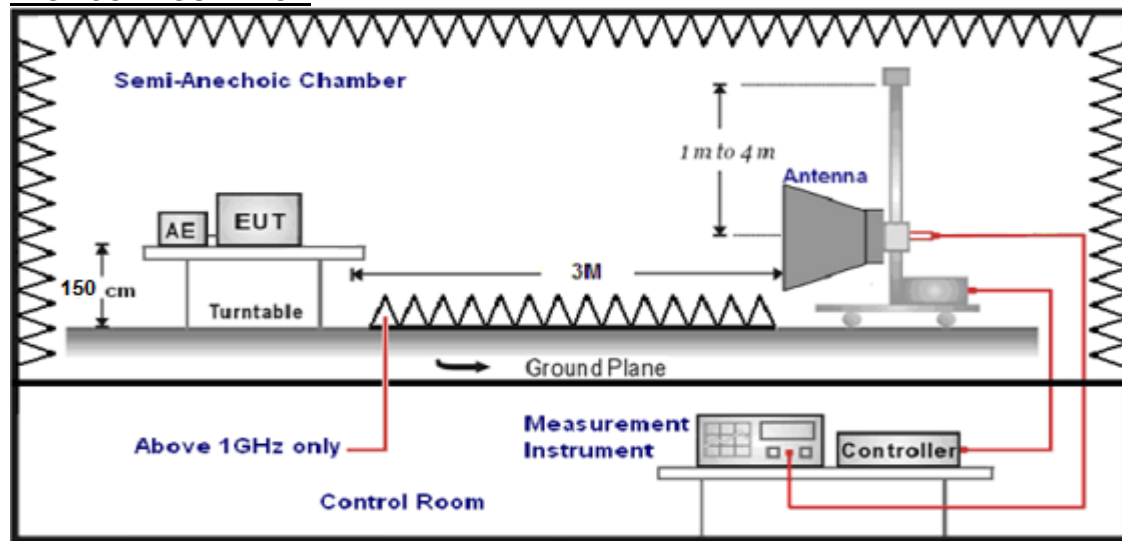

LIMIT

20dBc in any 100 kHz bandwidth outside the operating frequency band. In case the emission fall within the restricted band specified on 15.205(a), then the 15.209(a) limit in the table below has to be followed.

Frequency (MHz)	Distance (Meters)	Radiated (dBµV/m)	Radiated (µV/m)
0.009-0.49	3	$20\log(2400/F(KHz))+40\log(300/3)$	$2400/F(KHz)$
0.49-1.705	3	$20\log(24000/F(KHz))+40\log(30/3)$	$24000/F(KHz)$
1.705-30	3	$20\log(30)+40\log(30/3)$	30
30-88	3	40.0	100
88-216	3	43.5	150
216-960	3	46.0	200
Above 960	3	54.0	500

According to §15.407 (b): Except as shown in paragraph (b)(7) of this section, the maximum emissions outside of the frequency bands of operation shall be attenuated in accordance with the following limits

Frequency (MHz)	EIRP Limit (dBm)	Equivalent Field Strength at 3m (dBµV/m)
5150-5250	-27	68.2
5250-5350	-27	68.2
5470-5725	-27	68.2
5725-5850	-27 (beyond 10MHz of the band edge)	68.2
	-17 (within 10 MHz of band edge)	78.2

TEST PROCEDURE

- The EUT was placed on a turn table which is 1.5m above 1GHz.
- Maximum procedure was performed by raising the receiving antenna from 1m to 4m and rotating the turn table from 0° to 360° to acquire the highest emissions from EUT.
- And also, each emission was to be maximized by changing the polarization of receiving antenna both horizontal and vertical.
- Repeat above procedures until all frequency measurements have been completed..
- The distance between test antenna and EUT as following table states:

Test Frequency range	Test Antenna Type	Test Distance
1GHz-18GHz	Double Ridged Horn Antenna	3

- Setting test receiver/spectrum as following table states:

Test Frequency range	Test Receiver/Spectrum Setting	Detector
1GHz-18GHz	Peak Value: RBW=1MHz/VBW=3MHz, Sweep time=Auto Average Value: RBW=1MHz/VBW=10Hz, Sweep time=Auto	Peak

Field Strength Calculation

The field strength is calculated by adding the Antenna Factor and Cable Factor and subtracting the Amplifier Gain and Duty Cycle Correction Factor(if any) from the measured reading. The basic equation with a sample calculation is as follows:

$$FS = RA + AF + CL - AG$$

Where FS = Field Strength	CL = Cable Attenuation Factor (Cable Loss)
RA = Reading Amplitude	AG = Amplifier Gain
AF = Antenna Factor	

TEST RESULTS

Remark:For radiated bandedge We measured at both mode, recorded worst case in antenna 1's 802.11 ac20 mode;

For Radiated Bandedge Measurement

Temperature	23.4°C	Humidity	54.5%
Test Engineer	Evan Ouyang	Configurations	IEEE 802.11a/n/ac

802.11 ac20/ Channel 36 :5180 MHz									
Freq (MHz)	Read Level (dBµV)	Antenna Factor (dB/m)	PRM Factor (dB)	Cable Loss (dB)	Result Level (dBµV/m)	Limit Line (dBµV/m)	Margin (dB)	Detector	Polarization
4500.0	35.09	35.58	29.04	8.28	49.91	68.20	-18.29	Peak	Horizontal
4500.0	30.29	35.58	29.04	8.28	45.11	54.00	-8.89	AV	Horizontal
5150.0	39.02	35.58	29.04	8.28	53.84	68.20	-14.36	Peak	Horizontal
5150.0	30.57	35.58	29.04	8.28	45.39	54.00	-8.61	AV	Horizontal

802.11 ac20/ Channel 36 :5180 MHz									
Freq (MHz)	Read Level (dBµV)	Antenna Factor (dB/m)	PRM Factor (dB)	Cable Loss (dB)	Result Level (dBµV/m)	Limit Line (dBµV/m)	Margin (dB)	Detector	Polarization
4500.0	35.16	35.58	29.04	8.28	49.98	68.20	-18.22	Peak	Vertical
4500.0	30.04	35.58	29.04	8.28	44.86	54.00	-9.14	AV	Vertical
5150.0	39.27	35.58	29.04	8.28	54.09	68.20	-14.11	Peak	Vertical
5150.0	30.54	35.58	29.04	8.28	45.36	54.00	-8.64	AV	Vertical

802.11 ac20/ Channel 48 :5240 MHz									
Freq (MHz)	Read Level (dBµV)	Antenna Factor (dB/m)	PRM Factor (dB)	Cable Loss (dB)	Result Level (dBµV/m)	Limit Line (dBµV/m)	Margin (dB)	Detector	Polarization
5350.0	35.05	35.42	29.06	8.39	49.80	68.20	-18.40	Peak	Horizontal
5350.0	30.41	35.42	29.06	8.39	45.16	54.00	-8.84	AV	Horizontal
5460.0	39.25	35.42	29.06	8.39	54.00	68.20	-14.20	Peak	Horizontal
5460.0	30.61	35.42	29.06	8.39	45.36	54.00	-8.64	AV	Horizontal

802.11 ac20/ Channel 48 :5240 MHz									
Freq (MHz)	Read Level (dBµV)	Antenna Factor (dB/m)	PRM Factor (dB)	Cable Loss (dB)	Result Level (dBµV/m)	Limit Line (dBµV/m)	Margin (dB)	Detector	Polarization
5350.0	35.29	35.42	29.06	8.39	50.04	68.20	-18.16	Peak	Vertical
5350.0	30.24	35.42	29.06	8.39	44.99	54.00	-9.01	AV	Vertical
5460.0	39.05	35.42	29.06	8.39	53.80	68.20	-14.40	Peak	Vertical
5460.0	30.59	35.42	29.06	8.39	45.34	54.00	-8.66	AV	Vertical

802.11 ac20/ Channel 149 :5745 MHz									
Freq (MHz)	Read Level (dBµV)	Antenna Factor (dB/m)	PRM Factor (dB)	Cable Loss (dB)	Result Level (dBµV/m)	Limit Line (dBµV/m)	Margin (dB)	Detector	Polarization
5650.0	30.16	35.29	29.18	8.8	45.07	68.20	-23.13	Peak	Horizontal
5700.0	30.37	35.29	29.18	8.8	45.28	54.00	-8.72	Peak	Horizontal
5720.0	32.02	35.29	29.18	8.8	46.93	68.20	-21.27	Peak	Horizontal
5725.0	30.56	35.29	29.18	8.8	45.47	54.00	-8.53	Peak	Horizontal

802.11 ac20/ Channel 149 :5745 MHz									
Freq (MHz)	Read Level (dBµV)	Antenna Factor (dB/m)	PRM Factor (dB)	Cable Loss (dB)	Result Level (dBµV/m)	Limit Line (dBµV/m)	Margin (dB)	Detector	Polarization
5650.0	46.00	35.29	29.18	8.8	60.91	68.20	-7.29	Peak	Vertical
5700.0	35.10	35.29	29.18	8.8	50.01	68.20	-18.19	Peak	Vertical
5720.0	47.22	35.29	29.18	8.8	62.13	68.20	-6.07	Peak	Vertical
5725.0	35.80	35.29	29.18	8.8	50.71	68.20	-17.49	Peak	Vertical

802.11 ac20/ Channel 165 :5825 MHz									
Freq (MHz)	Read Level (dBµV)	Antenna Factor (dB/m)	PRM Factor (dB)	Cable Loss (dB)	Result Level (dBµV/m)	Limit Line (dBµV/m)	Margin (dB)	Detector	Polarization
5850.0	45.94	33.21	35.82	9.52	52.85	68.20	-15.35	Peak	Horizontal
5855.0	35.59	33.21	35.82	9.52	42.50	68.20	-25.70	Peak	Horizontal
5875.0	47.37	32.82	35.82	9.52	53.89	68.20	-14.31	Peak	Horizontal
5925.0	35.61	32.82	35.82	9.52	42.13	68.20	-26.07	Peak	Horizontal

802.11 ac20/ Channel 165 :5825 MHz									
Freq (MHz)	Read Level (dBµV)	Antenna Factor (dB/m)	PRM Factor (dB)	Cable Loss (dB)	Result Level (dBµV/m)	Limit Line (dBµV/m)	Margin (dB)	Detector	Polarization
5850.0	45.17	33.21	35.82	9.52	52.08	68.20	-16.12	Peak	Vertical
5855.0	34.69	33.21	35.82	9.52	41.60	54.00	-12.40	Peak	Vertical
5875.0	46.50	32.82	35.82	9.52	53.02	68.20	-15.18	Peak	Vertical
5925.0	35.05	32.82	35.82	9.52	41.57	54.00	-12.43	Peak	Vertical

REMARKS:

1. Result Level = Read Level + Antenna Factor + Cable loss - PRM Factor.
2. Margin value = Result Level-Limit value.
2. The other emission levels were very low against the limit.
3. The average measurement was not performed when the peak measured data under the limit of average detection.
4. Detector AV is setting spectrum/receiver. RBW=1MHz/VBW=10Hz/Sweep time=Auto/Detector=Peak;

For Conducted Band edge Measurement

For reporting purpose only.

Antenna 1:

Please refer to Appendix D-ANT 1-Appendix D.6.

Please refer to Appendix E-ANT 1-Appendix E.6.

Antenna 2:

Please refer to Appendix D-ANT 2-Appendix D.6.

Please refer to Appendix E-ANT 2-Appendix E.6.

For Conducted Spurious Emissions Measurement

For reporting purpose only.

Antenna 1:

Please refer to Appendix D-ANT 1-Appendix D.7.

Please refer to Appendix E-ANT 1-Appendix E.7.

Antenna 2:

Please refer to Appendix D-ANT 2-Appendix D.7.

Please refer to Appendix E-ANT 2-Appendix E.7.

4.9. Frequency Stability

Standard Applicable

According to FCC §15.407(g) “Manufacturers of U-NII devices are responsible for ensuring frequency stability such that an emission is maintained within the band of operation under all conditions of normal operation as specified in the user manual.”

According to FCC §2.1055(a) “The frequency stability shall be measured with variation of ambient temperature as follows:”

(1) From -30° to + 50° centigrade for all equipment except that specified in paragraphs (a) (2) and (3) of this section.

(2) From -20° to + 50° centigrade for equipment to be licensed for use in the Maritime Services under part 80 of this chapter, except for Class A, B, and S Emergency Position Indicating Radiobeacons (EPIRBS), and equipment to be licensed for use above 952 MHz at operational fixed stations in all services, stations in the Local Television Transmission Service and Point-to-Point Microwave Radio Service under part 21 of this chapter, equipment licensed for use aboard aircraft in the Aviation Services under part 87 of this chapter, and equipment authorized for use in the Family Radio Service under part 95 of this chapter.

(3) From 0° to + 50° centigrade for equipment to be licensed for use in the Radio Broadcast Services under part 73 of this chapter.

Test Configuration

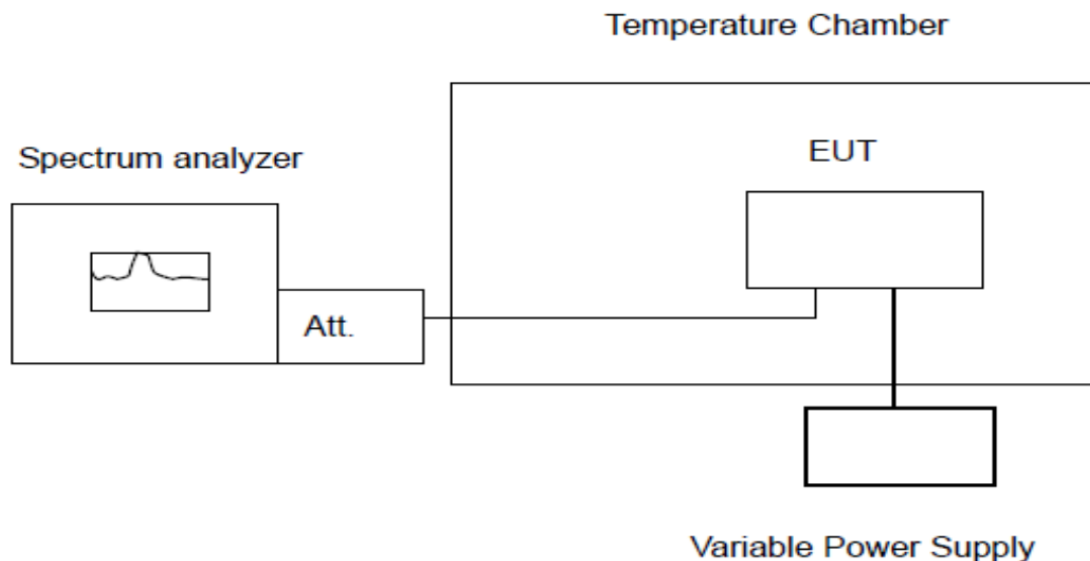

Test Procedure

The equipment under test was connected to an external AC or DC power supply and input rated voltage. RF output was connected to a frequency counter or spectrum analyzer via feed through attenuators. The EUT was placed inside the temperature chamber. Set the spectrum analyzer RBW low enough to obtain the desired frequency resolution and measure EUT 20 degree operating frequency as reference frequency. Turn EUT off and set the chamber temperature to -30 degree. After the temperature stabilized for approximately 30 minutes recorded the frequency. Repeat step measure with 10 degree increased per stage until the highest temperature of +50 degree reached.

Test Results

PASS

Remark:

1. Measured all conditions and recorded worst case.

IEEE 802.11a Mode / 5180 – 5240 MHz / 5180 MHz

Environment Temperature (Degree)	Voltage (V)	Measured Frequency (MHz)	Limit Range (MHz)	Test Results
20	DC 8.36V	5171.533286	5150 – 5250	PASS
20	DC 6.84V	5171.628070	5150 – 5250	PASS
50	DC 7.6V	5171.633803	5150 – 5250	PASS
40	DC 7.6V	5171.651900	5150 – 5250	PASS
30	DC 7.6V	5171.573440	5150 – 5250	PASS
20	DC 7.6V	5171.567852	5150 – 5250	PASS
10	DC 7.6V	5171.599478	5150 – 5250	PASS
0	DC 7.6V	5171.671012	5150 – 5250	PASS
-10	DC 7.6V	5171.585113	5150 – 5250	PASS
-20	DC 7.6V	5171.663375	5150 – 5250	PASS
-30	DC 7.6V	5171.678635	5150 – 5250	PASS

IEEE 802.11a Mode / 5180 – 5240 MHz / 5240 MHz

Environment Temperature (Degree)	Voltage (V)	Measured Frequency (MHz)	Limit Range (MHz)	Test Results
20	DC 8.36V	5248.618029	5150 – 5250	PASS
20	DC 6.84V	5248.527515	5150 – 5250	PASS
50	DC 7.6V	5248.517367	5150 – 5250	PASS
40	DC 7.6V	5248.566848	5150 – 5250	PASS
30	DC 7.6V	5248.644268	5150 – 5250	PASS
20	DC 7.6V	5248.522357	5150 – 5250	PASS
10	DC 7.6V	5248.668542	5150 – 5250	PASS
0	DC 7.6V	5248.694840	5150 – 5250	PASS
-10	DC 7.6V	5248.577561	5150 – 5250	PASS
-20	DC 7.6V	5248.589883	5150 – 5250	PASS
-30	DC 7.6V	5248.620495	5150 – 5250	PASS

IEEE 802.11a Mode / 5745 – 5825 MHz / 5745 MHz

Environment Temperature (Degree)	Voltage (V)	Measured Frequency (MHz)	Limit Range (MHz)	Test Results
20	DC 8.36V	5736.633721	5725 – 5850	PASS
20	DC 6.84V	5736.592417	5725 – 5850	PASS
50	DC 7.6V	5736.697872	5725 – 5850	PASS
40	DC 7.6V	5736.606261	5725 – 5850	PASS
30	DC 7.6V	5736.548696	5725 – 5850	PASS
20	DC 7.6V	5736.508390	5725 – 5850	PASS
10	DC 7.6V	5736.611737	5725 – 5850	PASS
0	DC 7.6V	5736.634710	5725 – 5850	PASS
-10	DC 7.6V	5736.548864	5725 – 5850	PASS
-20	DC 7.6V	5736.571245	5725 – 5850	PASS
-30	DC 7.6V	5736.684325	5725 – 5850	PASS

IEEE 802.11a Mode / 5745 – 5825 MHz / 5825 MHz

Environment Temperature (Degree)	Voltage (V)	Measured Frequency (MHz)	Limit Range (MHz)	Test Results
20	DC 8.36V	5833.647367	5725 – 5850	PASS
20	DC 6.84V	5833.612358	5725 – 5850	PASS
50	DC 7.6V	5833.629914	5725 – 5850	PASS
40	DC 7.6V	5833.518167	5725 – 5850	PASS
30	DC 7.6V	5833.688557	5725 – 5850	PASS
20	DC 7.6V	5833.630113	5725 – 5850	PASS
10	DC 7.6V	5833.563007	5725 – 5850	PASS
0	DC 7.6V	5833.654114	5725 – 5850	PASS
-10	DC 7.6V	5833.576258	5725 – 5850	PASS
-20	DC 7.6V	5833.607241	5725 – 5850	PASS
-30	DC 7.6V	5833.501337	5725 – 5850	PASS

4.10. Antenna Requirement

Standard Applicable

For intentional device, according to FCC 47 CFR Section 15.203, an intentional radiator shall be designed to ensure that no antenna other than that furnished by the responsible party shall be used with the device.

And according to FCC 47 CFR Section 15.407 (a), if transmitting antennas of directional gain greater than 6dBi are used, the power shall be reduced by the amount in dB that the directional gain of the antenna exceeds 6dBi.

Antenna Information

The antenna is FPC Aantenna, through the buckle stretched out, The directional gains of antenna used for transmitting is 2.0dBi.

Reference to the Test Report: **GTS20241014025-3-01**.

5. TEST SETUP PHOTOS OF THE EUT

Reference to the test report No. GTS20241014025-3-01.

6. EXTERNAL AND INTERNAL PHOTOS OF THE EUT

Reference to the test report No. GTS20241014025-3-01.

.....**End of Report**.....