



FCC RADIO TEST REPORT

FCC ID : MCL951993A
Equipment : Hon Hai Precision Ind. Co., Ltd.
Brand Name : Foxconn
Model Name : 95.1993T01
Marketing Name : 95.1993T01
Applicant : Hon Hai Precision Ind. Co., Ltd.
5F-1, 5 Hsin-An Road, Hsinchu,
Science-Based Industrial Park, Taiwan
Manufacturer : Hon Hai Precision Ind. Co., Ltd.
5F-1, 5 Hsin-An Road, Hsinchu,
Science-Based Industrial Park, Taiwan
Standard : 47 CFR Part 2, 24(E), 27

The product was received on Dec. 07, 2018 and testing was started from Dec. 11, 2018 and completed on Jan. 12, 2019. We, SPORTON INTERNATIONAL INC. EMC & Wireless Communications Laboratory, would like to declare that the tested sample has been evaluated in accordance with the test procedures given in ANSI / TIA-603-E and has been in compliance with the applicable technical standards.

The report must not be used by the client to claim product certification, approval, or endorsement by TAF or any agency of government.

The test results in this report apply exclusively to the tested model / sample. Without written approval of SPORTON INTERNATIONAL INC. EMC & Wireless Communications Laboratory, the test report shall not be reproduced except in full.

Approved by: Jones Tsai

SPORTON INTERNATIONAL INC. EMC & Wireless Communications Laboratory

No. 52, Huaya 1st Rd., Guishan Dist., Taoyuan City, Taiwan (R.O.C.)



Table of Contents

History of this test report.....	3
Summary of Test Result.....	4
1 General Description	6
1.1 Product Feature of Equipment Under Test.....	6
1.2 Modification of EUT	6
1.3 Testing Location	6
1.4 Applicable Standards.....	7
2 Test Configuration of Equipment Under Test	8
2.1 Test Mode.....	8
2.2 Connection Diagram of Test System.....	10
2.3 Support Unit used in test configuration and system	10
2.4 Measurement Results Explanation Example.....	10
2.5 Frequency List of Low/Middle/High Channels	11
3 Conducted Test Items.....	16
3.1 Measuring Instruments	16
3.2 Conducted Output Power and EIRP	17
3.3 Peak-to-Average Ratio	18
3.4 Occupied Bandwidth.....	19
3.5 Conducted Band Edge	20
3.6 Conducted Spurious Emission	21
3.7 Frequency Stability	22
4 Radiated Test Items	23
4.1 Measuring Instruments	23
4.2 Radiated Spurious Emission Measurement	24
5 List of Measuring Equipment.....	25
6 Uncertainty of Evaluation.....	27
Appendix A. Test Results of Conducted Test	
Appendix B. Test Results of EIRP and Radiated Test	
Appendix C. Test Setup Photographs	



History of this test report

Report No.	Version	Description	Issued Date
FG851104-01	01	Initial issue of report	Feb. 12, 2019



Summary of Test Result

Report Clause	Ref Std. Clause	Test Items	Result (PASS/FAIL)	Remark
3.2	§2.1046 §27.50 (h)(2)	Conducted Output Power (Band 41)	Pass	-
	§24.232 (c)	Equivalent Isotropic Radiated Power (Band 25)	Pass	
3.3	§24.232 (d)	Peak-to-Average Ratio	Pass	-
3.4	§2.1049	Occupied Bandwidth	Reporting only	-
3.5	§2.1051 §24.238 (a)	Conducted Band Edge Measurement (Band 25)	Pass	-
	§2.1051 §27.53 (m)(4)	Conducted Band Edge Measurement (Band 41)		
3.6	§2.1051 §24.238 (a)	Conducted Spurious Emission (Band 25)	Pass	-
	§2.1051 §27.53 (m)(4)	Conducted Spurious Emission (Band 41)		
3.7	§2.1055 §24.235 §27.54	Frequency Stability Temperature & Voltage	Pass	-
4.2	§2.1053 §24.238 (a)	Radiated Spurious Emission (Band 25)	Pass	Under limit 3.08 dB at 7572.000 MHz
	§2.1053 §27.53 (m)(4)	Radiated Spurious Emission (Band 41)		



Declaration of Conformity:

The test results with all measurement uncertainty excluded are presented in accordance with the regulation limits or requirements declared by manufacturers.

Comments and Explanations:

The declared of product specification for EUT presented in the report are provided by the manufacturer, and the manufacturer takes all the responsibilities for the accuracy of product specification.

Reviewed by: Wii Chang

Report Producer: Polly Tsai



1 General Description

1.1 Product Feature of Equipment Under Test

LTE

Product Specification subjective to this standard	
Antenna Type	WWAN: <Ant. 1>: Patch Antenna <Ant. 2>: Patch Antenna <Ant. 3>: Patch Antenna <Ant. 4>: Patch Antenna

1.2 Modification of EUT

No modifications are made to the EUT during all test items.

1.3 Testing Location

Test Site	SPORTON INTERNATIONAL INC.
Test Site Location	No.52, Huaya 1st Rd., Guishan Dist., Taoyuan City, Taiwan (R.O.C.) TEL: +886-3-327-3456 FAX: +886-3-328-4978
Test Site No.	Sporton Site No. TH05-HY

Note: The test site complies with ANSI C63.4 2014 requirement.

Test Site	SPORTON INTERNATIONAL INC.
Test Site Location	No.58, Aly. 75, Ln. 564, Wenhua 3rd, Rd., Guishan Dist., Taoyuan City, Taiwan (R.O.C.) TEL: +886-3-327-0868 FAX: +886-3-327-0855
Test Site No.	Sporton Site No. 03CH10-HY

Note: The test site complies with ANSI C63.4 2014 requirement.

FCC Designation No.: TW1190 and TW0007



1.4 Applicable Standards

According to the specifications of the manufacturer, the EUT must comply with the requirements of the following standards:

- ♦ ANSI C63.26-2015
- ♦ ANSI / TIA-603-E
- ♦ 47 CFR Part 2, 24(E), 27
- ♦ FCC KDB 971168 D01 Power Meas. License Digital Systems v03r01
- ♦ FCC KDB 412172 D01 Determining ERP and EIRP v01r01

Remark:

1. All test items were verified and recorded according to the standards and without any deviation during the test.
2. This EUT has also been tested and complied with the requirements of FCC Part 15, Subpart B, recorded in a separate test report.



2 Test Configuration of Equipment Under Test

2.1 Test Mode

Antenna port conducted and radiated test items listed below are performed according to KDB 971168 D01 Power Meas. License Digital Systems v03r01 with maximum output power.

Test Items	Band	Bandwidth (MHz)						Modulation			RB #			Test Channel		
		1.4	3	5	10	15	20	QPSK	16QAM	64QAM	1	Half	Full	L	M	H
Max. Output Power	25			v	v	v	v	v	v	v	v	v	v	v	v	v
	41	-	-	v	v	v	v	v	v	v	v	v	v	v	v	v
Peak-to-Average Ratio	25						v	v	v		v		v	v	v	v
	41	-	-				v	v	v		v		v	v	v	v
26dB and 99% Bandwidth	25			v	v	v	v	v	v				v	v	v	v
	41	-	-	v	v	v	v	v	v				v	v	v	v
Conducted Band Edge	25			v	v	v	v	v	v		v		v			v
	41	-	-	v	v	v	v	v	v		v		v			v
Conducted Spurious Emission	25			v	v	v	v	v	v		v			v	v	v
	41	-	-	v	v	v	v	v	v		v			v	v	v
Frequency Stability	25				v			v					v		v	
	41	-	-		v			v					v		v	
EIRP	25			v	v	v	v	v	v	v	v			v	v	v
	41	-	-	v	v	v	v	v	v	v	v			v	v	v
Radiated Spurious Emission	25	Worst Case											v	v	v	
	41	Worst Case											v	v	v	
Remark	<ol style="list-style-type: none"> The mark "v" means that this configuration is chosen for testing The mark "-" means that this bandwidth is not supported. The device is investigated from 30MHz to 10 times of fundamental signal for radiated spurious emission test under different RB size/offset and modulations in exploratory test. Subsequently, only the worst case emissions are reported. 															



Test Items	Band	Bandwidth (MHz)									Modulation			RB #			Test Channel					
		20+20	20+15	15+20	20+10	10+20	20+5	5+20	15+15	15+10	10+15	QPSK	16QAM	64QAM	1	Half	Full	L	M	H		
Max. Output Power	41_CA	v	v	v	v	v	v	v	v	v	v	v	v	v	v	v	v	v	v	v		
26dB and 99% Bandwidth	41_CA	v	v	v	v	v	v	v	v	v	v	v	v	v				v	v	v		
Conducted Band Edge	41_CA	v	v	v	v	v	v	v	v	v	v	v	v	v	v		v	v	v			
Conducted Spurious Emission	41_CA	v	v	v	v	v	v	v	v	v	v	v	v	v	v				v	v	v	
E.I.R.P.	41_CA	v	v	v	v	v	v	v	v	v	v	v	v	v	v				v	v	v	
Radiated Spurious Emission	41_CA	Worst Case																		v	v	v
Remark	1. The mark "v " means that this configuration is chosen for testing 2. The mark "- " means that this bandwidth is not supported. 3. The device is investigated from 30MHz to 10 times of fundamental signal for radiated spurious emission test under different RB size/offset and modulations in exploratory test. Subsequently, only the worst case emissions are reported.																					

2.2 Connection Diagram of Test System

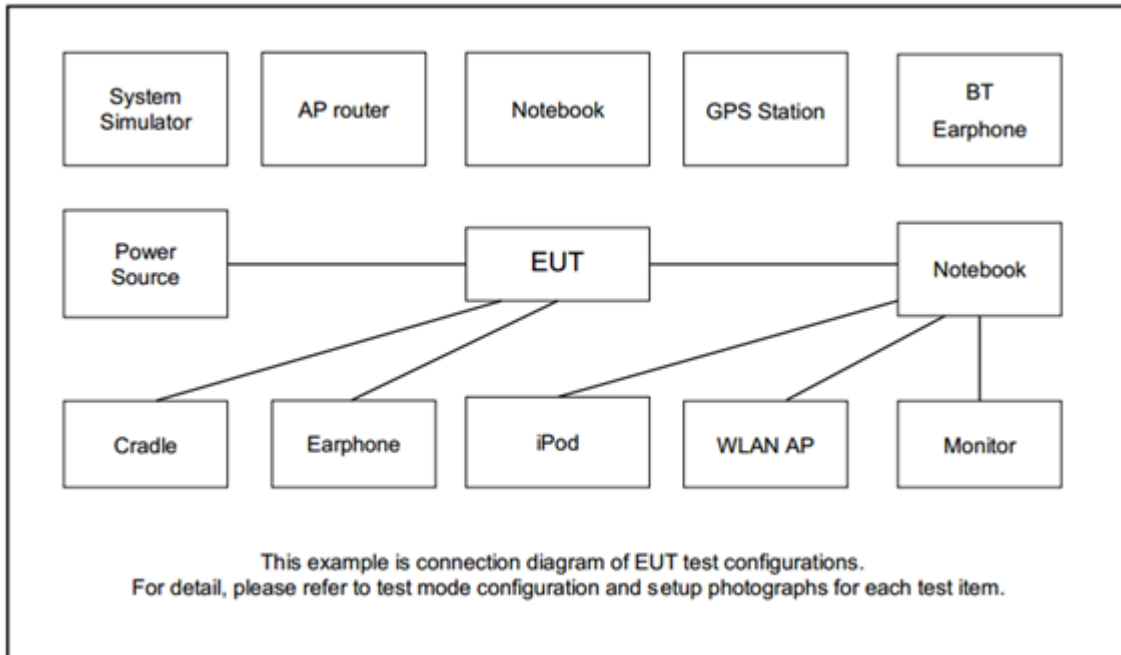

2.3 Support Unit used in test configuration and system

Item	Equipment	Trade Name	Model No.	FCC ID	Data Cable	Power Cord
1.	Power Supply	GWINSTEK	PSS-2002	N/A	N/A	Unshielded, 1.8 m
2.	LTE Base Station	Anritsu	MT8820C	N/A	N/A	Unshielded, 1.8 m
3.	Fixture	Foxconn	N/A	N/A	N/A	N/A
4.	Adapter	Ktec	KSA-40A-050800HU	N/A	N/A	N/A

2.4 Measurement Results Explanation Example

For all conducted test items:

The offset level is set in the spectrum analyzer to compensate the RF cable loss and attenuator factor between EUT conducted output port and spectrum analyzer. With the offset compensation, the spectrum analyzer reading level is exactly the EUT RF output level.

The spectrum analyzer offset is derived from RF cable loss and attenuator factor.

Offset = RF cable loss + attenuator factor.

Following shows an offset computation example with cable loss 4.2 dB and 10dB attenuator.

Example :

$$\begin{aligned} \text{Offset}(dB) &= \text{RF cable loss}(dB) + \text{attenuator factor}(dB). \\ &= 4.2 + 10 = 14.2 \text{ (dB)} \end{aligned}$$



2.5 Frequency List of Low/Middle/High Channels

LTE Band 25 Channel and Frequency List				
BW [MHz]	Channel/Frequency(MHz)	Lowest	Middle	Highest
20	Channel	26140	26340	26590
	Frequency	1860	1880	1905
15	Channel	26115	26340	26615
	Frequency	1857.5	1880	1907.5
10	Channel	26090	26340	26640
	Frequency	1855	1880	1910
5	Channel	26065	26340	26665
	Frequency	1852.5	1880	1912.5

LTE Band 41 Low Band Channel and Frequency List				
BW [MHz]	Channel/Frequency(MHz)	Lowest	Middle	Highest
20	Channel	39750	40010	40270
	Frequency	2506.0	2532.0	2558.0
15	Channel	39725	40010	40295
	Frequency	2503.5	2532.0	2560.5
10	Channel	39700	40010	40320
	Frequency	2501.0	2532.0	2563.0
5	Channel	39675	40010	40345
	Frequency	2498.5	2532.0	2565.5

LTE Band 41 High Band Channel and Frequency List				
BW [MHz]	Channel/Frequency(MHz)	Lowest	Middle	Highest
20	Channel	40970	41230	41490
	Frequency	2628.0	2654.0	2680.0
15	Channel	40945	41230	41515
	Frequency	2625.5	2654.0	2682.5
10	Channel	40920	41230	41540
	Frequency	2623.0	2654.0	2685.0
5	Channel	40895	41230	41565
	Frequency	2620.5	2654.0	2687.5



LTE Band 41C Low Band Channel and Frequency List					
BW [MHz]	Channel/Frequency(MHz)		Lowest	Middle	Highest
20 + 20	PCC	Channel	39750	39911	40072
		Frequency	2506	2522.1	2538.2
	SCC	Channel	39948	40109	40270
		Frequency	2525.8	2541.9	2558
20 + 15	PCC	Channel	39750	39937	40124
		Frequency	2506	2524.7	2543.4
	SCC	Channel	39921	40108	40295
		Frequency	2523.1	2541.8	2560.5
15 + 20	PCC	Channel	39725	39912	40099
		Frequency	2503.5	2522.2	2540.9
	SCC	Channel	39896	40083	40270
		Frequency	2520.6	2539.3	2558
20 + 10	PCC	Channel	39750	39963	40176
		Frequency	2506	2527.3	2548.6
	SCC	Channel	39894	40107	40320
		Frequency	2520.4	2541.7	2563
10 + 20	PCC	Channel	39700	39913	40126
		Frequency	2501	2522.3	2543.6
	SCC	Channel	39844	40057	40270
		Frequency	2515.4	2536.7	2558



LTE Band 41C Low Band Channel and Frequency List					
20 + 5	PCC	Channel	39750	39989	40228
		Frequency	2506	2529.9	2553.8
	SCC	Channel	39867	40106	40345
		Frequency	2517.7	2541.6	2565.5
5 + 20	PCC	Channel	39675	39914	40153
		Frequency	2498.5	2522.4	2546.3
	SCC	Channel	39792	40031	40270
		Frequency	2510.2	2534.1	2558
15 + 15	PCC	Channel	39725	39935	40145
		Frequency	2503.5	2524.5	2545.5
	SCC	Channel	39875	40085	40295
		Frequency	2518.5	2539.5	2560.5
10 + 15	PCC	Channel	39700	39940	40175
		Frequency	2501	2525	2548.5
	SCC	Channel	39820	40060	40295
		Frequency	2513	2537	2560.5
15 + 10	PCC	Channel	39725	39960	40200
		Frequency	2503.5	2527	2551
	SCC	Channel	39845	40080	40320
		Frequency	2515.5	2539	2563



LTE Band 41C High Band Channel and Frequency List					
BW [MHz]	Channel/Frequency(MHz)		Lowest	Middle	Highest
20 + 20	PCC	Channel	40970	41131	41292
		Frequency	2628	2644.1	2660.2
	SCC	Channel	41168	41329	41490
		Frequency	2647.8	2663.9	2680
20 + 15	PCC	Channel	40970	41157	41344
		Frequency	2628	2646.7	2665.4
	SCC	Channel	41141	41328	41515
		Frequency	2645.1	2663.8	2682.5
15 + 20	PCC	Channel	40945	41132	41319
		Frequency	2625.5	2644.2	2662.9
	SCC	Channel	41116	41303	41490
		Frequency	2642.6	2661.3	2680
20 + 10	PCC	Channel	40970	41183	41396
		Frequency	2628	2649.3	2670.6
	SCC	Channel	41114	41327	41540
		Frequency	2642.4	2663.7	2685
10 + 20	PCC	Channel	40920	41133	41346
		Frequency	2623	2644.3	2665.6
	SCC	Channel	41064	41277	41490
		Frequency	2637.4	2658.7	2680



LTE Band 41C High Band Channel and Frequency List					
20 + 5	PCC	Channel	40970	41209	41448
		Frequency	2628	2651.9	2675.8
	SCC	Channel	41087	41326	41565
		Frequency	2639.7	2663.6	2687.5
5 + 20	PCC	Channel	40895	41134	41373
		Frequency	2620.5	2644.4	2668.3
	SCC	Channel	41012	41251	41490
		Frequency	2632.2	2656.1	2680
15 + 15	PCC	Channel	40945	41155	41365
		Frequency	2625.5	2646.5	2667.5
	SCC	Channel	41095	41305	41515
		Frequency	2640.5	2661.5	2682.5
ve10 + 15	PCC	Channel	40920	39940	41395
		Frequency	2623	2525	2670.5
	SCC	Channel	41040	40060	41515
		Frequency	2635	2537	2682.5
15 + 10	PCC	Channel	40945	39960	41420
		Frequency	2625.5	2527	2673
	SCC	Channel	41065	40080	41540
		Frequency	2637.5	2539	2685

3 Conducted Test Items

3.1 Measuring Instruments

See list of measuring instruments of this test report.

3.1.1 Test Setup

3.1.2 Conducted Output Power

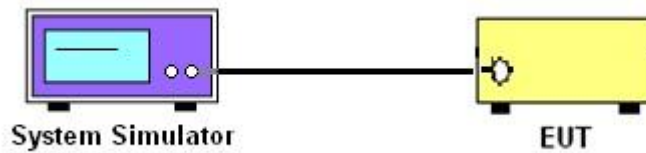

3.1.3 Peak-to-Average Ratio, Occupied Bandwidth ,Conducted Band-Edge and Conducted Spurious Emission

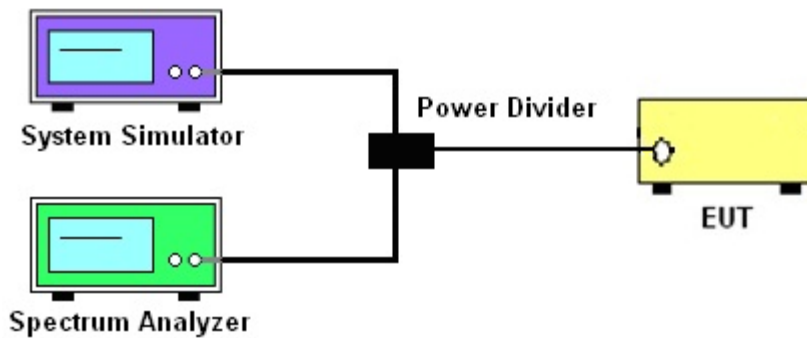

3.1.4 Frequency Stability



3.1.5 Test Result of Conducted Test

Please refer to Appendix A.



3.2 Conducted Output Power and EIRP

3.2.1 Description of the Conducted Output Power Measurement and EIRP Measurement

A system simulator was used to establish communication with the EUT. Its parameters were set to force the EUT transmitting at maximum output power. The measured power in the radio frequency on the transmitter output terminals shall be reported.

The EIRP of mobile transmitters must not exceed 2 Watts for LTE Band 25 and Band 41.

All user stations are limited to 2.0 watts transmitter output power for LTE band 41.

According to KDB 412172 D01 Power Approach,

$EIRP = P_T + G_T - L_C$, $ERP = EIRP - 2.15$, where

P_T = transmitter output power in dBm

G_T = gain of the transmitting antenna in dBi

L_C = signal attenuation in the connecting cable between the transmitter and antenna in dB

Note: The device is other user station then the EIRP test data for LTE Band 41 in this report is reporting only.

3.2.2 Test Procedures

1. The transmitter output port was connected to the system simulator.
2. Set EUT at maximum power through the system simulator.
3. Select lowest, middle, and highest channels for each band and different modulation.
4. Measure and record the power level from the system simulator.



3.3 Peak-to-Average Ratio

3.3.1 Description of the PAR Measurement

Power Complementary Cumulative Distribution Function (CCDF) curves provide a means for characterizing the power peaks of a digitally modulated signal on a statistical basis. A CCDF curve depicts the probability of the peak signal amplitude exceeding the average power level. Most contemporary measurement instrumentation include the capability to produce CCDF curves for an input signal provided that the instrument's resolution bandwidth can be set wide enough to accommodate the entire input signal bandwidth. In measuring transmissions in this band using an average power technique, the peak-to-average ratio (PAR) of the transmission may not exceed 13 dB.

3.3.2 Test Procedures

The testing follows ANSI C63.26-2015 Section 5.2.6

1. The EUT was connected to spectrum and system simulator via a power divider.
2. Set the CCDF (Complementary Cumulative Distribution Function) option in spectrum analyzer.
3. The highest RF powers were measured and recorded the maximum PAPR level associated with a probability of 0.1 %.
4. Record the deviation as Peak to Average Ratio.



3.4 Occupied Bandwidth

3.4.1 Description of Occupied Bandwidth Measurement

The occupied bandwidth is the width of a frequency band such that, below the lower and above the upper frequency limits, the mean powers emitted are each equal to a specified percentage 0.5% of the total mean transmitted power.

The 26 dB emission bandwidth is defined as the frequency range between two points, one above and one below the carrier frequency, at which the spectral density of the emission is attenuated 26 dB below the maximum in-band spectral density of the modulated signal. Spectral density (power per unit bandwidth) is to be measured with a detector of resolution bandwidth equal to approximately 1.0% of the emission bandwidth.

3.4.2 Test Procedures

The testing follows ANSI C63.26-2015 Section 5.4.3 (26dB) and Section 5.4.4 (99OB)

1. The EUT was connected to spectrum analyzer and system simulator via a power divider.
2. The spectrum analyzer center frequency is set to the nominal EUT channel center frequency. The span range for the spectrum analyzer shall be between two and five times the anticipated OBW.
3. The nominal resolution bandwidth (RBW) shall be in the range of 1 to 5 % of the anticipated OBW, and the VBW shall be at least 3 times the RBW.
4. Set the detection mode to peak, and the trace mode to max hold.
5. Determine the reference value: Set the EUT to transmit a modulated signal. Allow the trace to stabilize. Set the spectrum analyzer marker to the highest level of the displayed trace.
(this is the reference value)
6. Determine the “-26 dB down amplitude” as equal to (Reference Value – X).
7. Place two markers, one at the lowest and the other at the highest frequency of the envelope of the spectral display such that each marker is at or slightly below the “-X dB down amplitude” determined in step 6. If a marker is below this “-X dB down amplitude” value it shall be placed as close as possible to this value. The OBW is the positive frequency difference between the two markers.
8. Use the 99 % power bandwidth function of the spectrum analyzer and report the measured bandwidth.



3.5 Conducted Band Edge

3.5.1 Description of Conducted Band Edge Measurement

24.238 (a)

For operations in the 1850-1910 and 1930-1990 MHz band, the FCC limit is $43 + 10\log_{10}(P[\text{Watts}])$ dB below the transmitter power $P(\text{Watts})$ in a 1MHz bandwidth. However, in the 1 MHz bands immediately outside and adjacent to the frequency block a resolution bandwidth of at least one percent of the emission bandwidth of the fundamental emission of the transmitter may be employed.

27.53(m)(4)

For mobile digital stations, the attenuation factor shall be not less than $40 + 10 \log (P)$ dB on all frequencies between the channel edge and 5 megahertz from the channel edge, $43 + 10 \log (P)$ dB on all frequencies between 5 megahertz and X megahertz from the channel edge, and $55 + 10 \log (P)$ dB on all frequencies more than X megahertz from the channel edge, where X is the greater of 6 megahertz or the actual emission bandwidth as defined in paragraph (m)(6) of this section. In addition, the attenuation factor shall not be less than $43 + 10 \log (P)$ dB on all frequencies between 2490.5 MHz and 2496 MHz and $55 + 10 \log (P)$ dB at or below 2490.5 MHz. Mobile Satellite Service licensees operating on frequencies below 2495 MHz may also submit a documented interference complaint against BRS licensees operating on channel BRS Channel 1 on the same terms and conditions as adjacent channel BRS or EBS licensees.

3.5.2 Test Procedures

The testing follows ANSI C63.26-2015 Section 5.7.

1. The EUT was connected to spectrum analyzer and system simulator via a power divider.
2. The band edges of low and high channels for the highest RF powers were measured.
3. Set RBW $\geq 1\%$ EBW in the 1MHz band immediately outside and adjacent to the band edge.
4. Beyond the 1 MHz band from the band edge, RBW=1MHz was used.
5. Set spectrum analyzer with RMS detector.
6. The RF fundamental frequency should be excluded against the limit line in the operating frequency band.
7. Checked that all the results comply with the emission limit line.
The limit line is derived from $43 + 10\log(P)$ dB below the transmitter power $P(\text{Watts})$
8. For LTE Band 41, the other 40 dB, and 55 dB have additionally applied same calculation above.



3.6 Conducted Spurious Emission

3.6.1 Description of Conducted Spurious Emission Measurement

The power of any emission outside of the authorized operating frequency ranges must be lower than the transmitter power (P) by a factor of at least $43 + 10 \log (P)$ dB.

For Band 41:

The power of any emission outside of the authorized operating frequency ranges must be lower than the transmitter power (P) by a factor of at least $55 + 10 \log (P)$ dB.

It is measured by means of a calibrated spectrum analyzer and scanned from 30 MHz up to a frequency including its 10th harmonic.

3.6.2 Test Procedures

The testing follows ANSI C63.26-2015 Section 5.7.

1. The EUT was connected to spectrum analyzer and system simulator via a power divider.
2. The RF output of EUT was connected to the spectrum analyzer by RF cable and attenuator.
The path loss was compensated to the results for each measurement.
3. The middle channel for the highest RF power within the transmitting frequency was measured.
4. The conducted spurious emission for the whole frequency range was taken.
5. Make the measurement with the spectrum analyzer's RBW = 1MHz, VBW = 3MHz.
6. Set spectrum analyzer with RMS detector.
7. Taking the record of maximum spurious emission.
8. The RF fundamental frequency should be excluded against the limit line in the operating frequency band.
9. The limit line is derived from $43 + 10\log(P)$ dB below the transmitter power P(Watts)
10. For Band 41
The limit line is derived from $55 + 10\log(P)$ dB below the transmitter power P(Watts)



3.7 Frequency Stability

3.7.1 Description of Frequency Stability Measurement

24.235 & 27.54

The frequency stability shall be sufficient to ensure that the fundamental emission stays within the authorized frequency block.

3.7.2 Test Procedures for Temperature Variation

The testing follows FCC KDB 971168 D01 v03r01 Section 9.0.

1. The EUT was set up in the thermal chamber and connected with the system simulator.
2. With power OFF, the temperature was decreased to -30°C and the EUT was stabilized before testing. Power was applied and the maximum change in frequency was recorded within one minute.
3. With power OFF, the temperature was raised in 10°C step up to 50°C. The EUT was stabilized at each step for at least half an hour. Power was applied and the maximum frequency change was recorded within one minute.

3.7.3 Test Procedures for Voltage Variation

The testing follows FCC KDB 971168 D01 v03r01 Section 9.0.

1. The EUT was placed in a temperature chamber at 20±5° C and connected with the system simulator.
2. The power supply voltage to the EUT was varied from 85% to 115% of the nominal value measured at the input to the EUT.
3. The variation in frequency was measured for the worst case.

4 Radiated Test Items

4.1 Measuring Instruments

See list of measuring instruments of this test report.

4.1.1 Test Setup

For radiated test from 30MHz to 1GHz

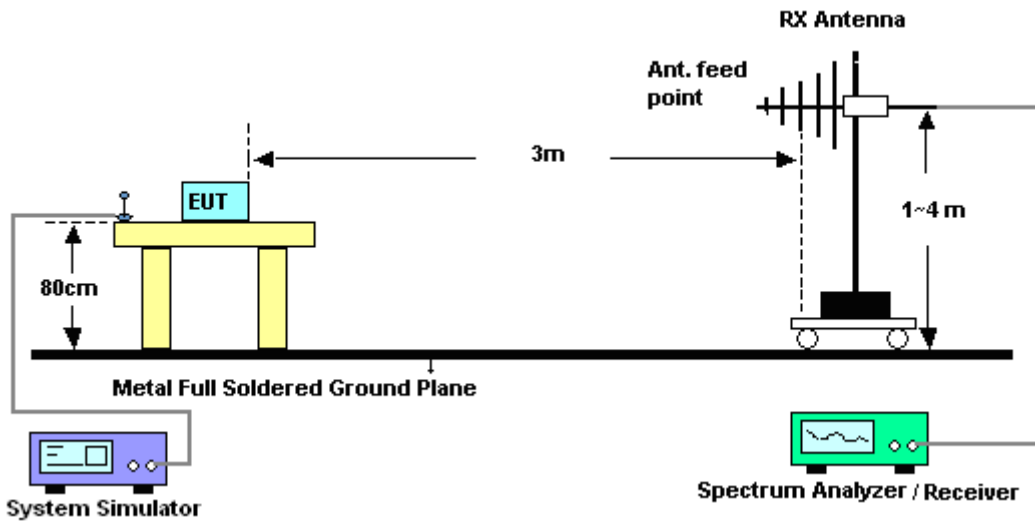

For radiated test above 1GHz

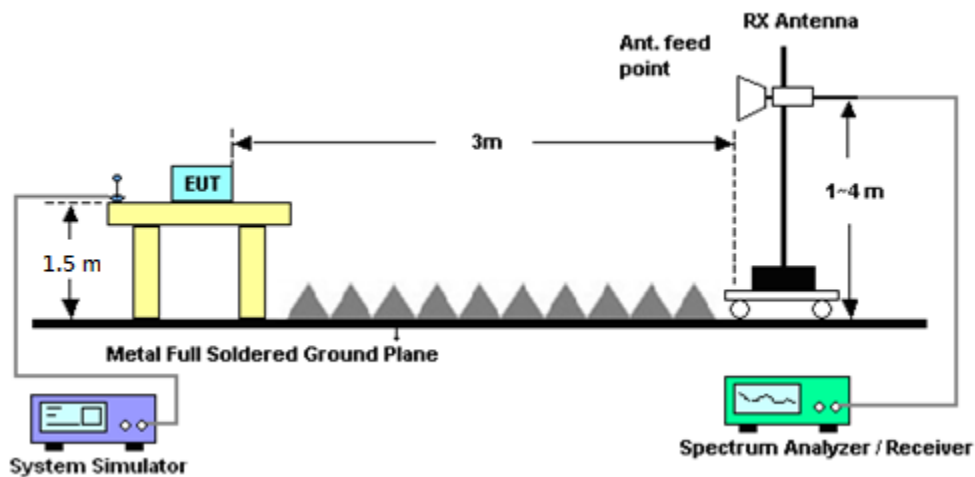

4.1.2 Test Result of Radiated Test

Please refer to Appendix B.



4.2 Radiated Spurious Emission Measurement

4.2.1 Description of Radiated Spurious Emission Measurement

The radiated spurious emission was measured by substitution method according to ANSI / TIA-603-E. The power of any emission outside of the authorized operating frequency ranges must be attenuated below the transmitter power (P) by a factor of at least $43 + 10 \log (P)$ dB.

For Band 41

The power of any emission outside of the authorized operating frequency ranges must be attenuated below the transmitter power (P) by a factor of at least $55 + 10 \log (P)$ dB.

The spectrum is scanned from 30 MHz up to a frequency including its 10th harmonic.

4.2.2 Test Procedures

The testing follows FCC KDB 971168 D01 v03r01 Section 5.8 and ANSI / TIA-603-E Section 2.2.12.

1. The EUT was placed on a turntable with 0.8 meter for frequency below 1GHz and 1.5 meter for frequency above 1GHz respectively above ground.
2. The EUT was set 3 meters from the receiving antenna, which was mounted on the antenna tower.
3. The table was rotated 360 degrees to determine the position of the highest spurious emission.
4. The height of the receiving antenna is varied between one meter and four meters to search the maximum spurious emission for both horizontal and vertical polarizations.
5. Make the measurement with the spectrum analyzer's RBW = 1MHz, VBW = 3MHz, taking the record of maximum spurious emission.
6. A horn antenna was substituted in place of the EUT and was driven by a signal generator.
7. Tune the output power of signal generator to the same emission level with EUT maximum spurious emission.
8. Taking the record of output power at antenna port.
9. Repeat step 7 to step 8 for another polarization.
10. The RF fundamental frequency should be excluded against the limit line in the operating frequency band.

The limit line is derived from $43 + 10\log(P)$ dB below the transmitter power P(Watts)

11. For Band 41:

The limit line is derived from $55 + 10\log(P)$ dB below the transmitter power P(Watts)

$EIRP \text{ (dBm)} = S.G. \text{ Power} - Tx \text{ Cable Loss} + Tx \text{ Antenna Gain}$

$ERP \text{ (dBm)} = EIRP - 2.15$



5 List of Measuring Equipment

Instrument	Manufacturer	Model No.	Serial No.	Characteristics	Calibration Date	Test Date	Due Date	Remark
LTE Base Station	Anritsu	MT8820C	6201432821	GSM/GPRS /WCDMA/LTE	Oct. 14, 2018	Dec. 11, 2018~ Jan. 12, 2019	Oct. 13, 2019	Conducted (TH05-HY)
Spectrum Analyzer	Rohde & Schwarz	FSV40	101397	10Hz~40GHz	Nov. 13, 2018	Dec. 11, 2018~ Jan. 12, 2019	Nov. 12, 2019	Conducted (TH05-HY)
Temperature Chamber	ESPEC	SH-641	92013720	-40°C~90°C	Aug. 29, 2018	Dec. 11, 2018~ Jan. 12, 2019	Aug. 28, 2019	Conducted (TH05-HY)
Programmable Power Supply	GW Instek	PSS-2005	EL890094	1V~20V 0.5A~5A	Oct. 02, 2018	Dec. 11, 2018~ Jan. 12, 2019	Oct. 01, 2019	Conducted (TH05-HY)
Coupler	Woken	0.5-18G 10 dB 30W	DOM5CIW3 A1	0.5-18GHz	Feb. 21, 2018	Dec. 11, 2018~ Jan. 12, 2019	Feb. 20, 2019	Conducted (TH05-HY)
Power Divider	Woken	0.5-18Ghz 2Way SMA Power Divider	Divider-4(DOM5C1W1E1)	0.5-18Ghz	Feb. 21, 2018	Dec. 11, 2018~ Jan. 12, 2019	Feb. 20, 2019	Conducted (TH05-HY)
Amplifier	SONOMA	310N	187311	9kHz~1GHz	Oct. 23, 2018	Jan. 04, 2019~ Jan. 05, 2019	Oct. 22, 2019	Radiation (03CH10-HY)
Base Station	Anritsu	MT8820C	6201432817	GSM / GPRS /WCDMA / LTE FDD/TDD with 44)	Dec. 12, 2018	Jan. 04, 2019~ Jan. 05, 2019	Dec. 11, 2020	Radiation (03CH10-HY)
Horn Antenna	SCHWARZBECK	BBHA 9120 D	9120D-1325	1GHz ~ 18GHz	Oct. 02, 2018	Jan. 04, 2019~ Jan. 05, 2019	Oct. 01, 2019	Radiation (03CH10-HY)
Preamplifier	Keysight	83017A	MY53270078	1GHz~26.5GHz	Oct. 28, 2018	Jan. 04, 2019~ Jan. 05, 2019	Oct. 27, 2019	Radiation (03CH10-HY)
Preamplifier	Jet-Power	JAP001018 00-30-10P	160118550004	1GHz~18GHz	Apr. 17, 2018	Jan. 04, 2019~ Jan. 05, 2019	Apr. 16, 2019	Radiation (03CH10-HY)
Spectrum Analyzer	Keysight	N9010A	MY54200485	10Hz ~ 44GHz	Nov. 02, 2018	Jan. 04, 2019~ Jan. 05, 2019	Nov. 01, 2019	Radiation (03CH10-HY)
Filter	Woken	100-12750MHz SMA	0100V1H010001G	1.0G High Pass	N/A	Jan. 04, 2019~ Jan. 05, 2019	N/A	Radiation (03CH10-HY)
Antenna Mast	EMEC	AM-BS-450 0-B	N/A	1~4m	N/A	Jan. 04, 2019~ Jan. 05, 2019	N/A	Radiation (03CH10-HY)
Turn Table	EMEC	TT 2200	N/A	0~360 Degree	N/A	Jan. 04, 2019~ Jan. 05, 2019	N/A	Radiation (03CH10-HY)
Software	Audix	E3 6.2009-8-24	RK-001042	N/A	N/A	Jan. 04, 2019~ Jan. 05, 2019	N/A	Radiation (03CH10-HY)
Filter	Wainwright	WHKX12-10 80-1200-150 0-60SS	SN2	1.2G High Pass	Sep. 16, 2018	Jan. 04, 2019~ Jan. 05, 2019	Sep. 15, 2019	Radiation (03CH10-HY)
Bilog Antenna	TESEQ	CBL6111D& 00800N1D0 1N-06	41912&05	30MHz to 1GHz	Jan. 10, 2018	Jan. 04, 2019~ Jan. 05, 2019	Jan. 09, 2019	Radiation (03CH10-HY)
EMI Test Receiver	Keysight	N9038A(MXE)	MY54130085	20Hz ~ 8.4GHz	Nov. 01, 2018	Jan. 04, 2019~ Jan. 05, 2019	Oct. 31, 2019	Radiation (03CH10-HY)



Instrument	Manufacturer	Model No.	Serial No.	Characteristics	Calibration Date	Test Date	Due Date	Remark
Preamplifier	EMEC	EM18G40G	060715	18GHz ~ 40GHz	Dec. 06, 2018	Jan. 04, 2019~ Jan. 05, 2019	Dec. 05, 2019	Radiation (03CH10-HY)
SHF-EHF Horn Antenna	SCHWARZBE CK	BBHA 9170	BBHA91705 84	18GHz- 40GHz	Dec. 05, 2018	Jan. 04, 2019~ Jan. 05, 2019	Dec. 04, 2019	Radiation (03CH10-HY)
Filter	Wainwright	WHKX12-27 00-3000-180 00-60ST	SN4	3 GHz Highpass	Sep. 17, 2018	Jan. 04, 2019~ Jan. 05, 2019	Sep. 16, 2019	Radiation (03CH10-HY)



6 Uncertainty of Evaluation

Uncertainty of Radiated Emission Measurement (30 MHz ~ 1000 MHz)

Measuring Uncertainty for a Level of Confidence of 95% ($U = 2Uc(y)$)	3.17
---	------

Uncertainty of Radiated Emission Measurement (1 GHz ~ 18 GHz)

Measuring Uncertainty for a Level of Confidence of 95% ($U = 2Uc(y)$)	3.48
---	------

Uncertainty of Radiated Emission Measurement (18 GHz ~ 40 GHz)

Measuring Uncertainty for a Level of Confidence of 95% ($U = 2Uc(y)$)	4.00
---	------



Appendix A. Test Results of Conducted Test

Conducted Output Power(Average power)

<For 2x2 Tx>

LTE Band 25 Maximum Average Power [dBm]						
BW [MHz]	RB Size	RB Offset	Mod	Lowest	Middle	Highest
20	1	0	QPSK	25.89	26.07	25.84
20	1	49		25.75	26.10	25.64
20	1	99		25.81	26.01	24.79
20	50	0		24.84	24.87	24.93
20	50	24		24.66	25.10	24.91
20	50	50		24.72	24.77	24.93
20	100	0		24.84	25.09	24.82
20	1	0	16-QAM	25.02	25.21	24.98
20	1	49		24.75	25.46	24.94
20	1	99		24.91	25.21	24.07
20	50	0		23.59	23.92	23.99
20	50	24		23.45	23.91	23.97
20	50	50		23.40	23.74	23.93
20	100	0		23.53	23.84	23.89
20	1	0	64-QAM	23.70	23.68	24.00
20	1	49		23.62	23.75	24.10
20	1	99		23.73	23.86	23.08
20	50	0		22.53	22.41	22.69
20	50	24		22.51	22.63	22.89
20	50	50		22.32	22.52	22.86
20	100	0		22.44	22.63	22.77
15	1	0	QPSK	25.53	25.78	26.03
15	1	37		25.74	26.07	25.74
15	1	74		25.56	25.84	24.37
15	36	0		24.48	24.85	24.67
15	36	20		24.47	25.03	25.02
15	36	39		24.33	24.75	24.97
15	75	0		24.43	25.06	24.95
15	1	0	16-QAM	24.82	25.16	25.16
15	1	37		24.91	25.30	25.01
15	1	74		24.89	24.96	23.68
15	36	0		23.42	23.90	23.84
15	36	20		23.54	23.86	24.02
15	36	39		23.49	23.70	23.90
15	75	0		23.40	23.84	24.01
15	1	0	64-QAM	23.86	23.93	24.06
15	1	37		23.93	24.02	23.96
15	1	74		23.62	23.85	22.74
15	36	0		22.54	22.70	22.77
15	36	20		22.72	22.91	23.09
15	36	39		22.62	22.57	23.12
15	75	0		22.47	22.80	23.05



LTE Band 25 Maximum Average Power [dBm]						
BW [MHz]	RB Size	RB Offset	Mod	Lowest	Middle	Highest
10	1	0	QPSK	25.31	25.84	25.57
10	1	25		25.52	26.01	25.90
10	1	49		25.88	25.65	24.36
10	25	0		24.62	25.01	24.92
10	25	12		24.70	24.95	25.11
10	25	25		24.58	24.73	24.80
10	50	0		24.63	24.79	24.81
10	1	0	16-QAM	24.71	25.08	24.92
10	1	25		24.74	25.15	24.98
10	1	49		25.07	24.87	23.62
10	25	0		23.51	23.79	23.97
10	25	12		23.58	23.91	23.97
10	25	25		23.66	23.67	23.66
10	50	0		23.56	23.77	23.64
10	1	0	64-QAM	23.20	23.42	23.40
10	1	25		23.26	23.71	23.25
10	1	49		23.46	23.44	21.74
10	25	0		22.45	22.72	22.65
10	25	12		22.24	22.65	22.43
10	25	25		22.24	22.53	22.07
10	50	0		22.10	22.43	22.20
5	1	0	QPSK	24.45	25.45	25.87
5	1	12		25.26	25.83	25.33
5	1	24		25.08	25.49	23.34
5	12	0		24.98	25.29	25.15
5	12	7		24.57	25.12	24.52
5	12	13		24.40	25.01	24.10
5	25	0		24.34	24.82	24.35
5	1	0	16-QAM	23.63	24.78	24.91
5	1	12		24.36	25.19	24.50
5	1	24		24.22	24.78	22.56
5	12	0		23.78	24.25	24.22
5	12	7		23.44	24.09	23.62
5	12	13		23.23	23.96	23.05
5	25	0		23.18	23.79	23.42
5	1	0	64-QAM	23.16	23.67	23.90
5	1	12		23.34	23.72	23.94
5	1	24		23.56	23.57	21.93
5	12	0		22.41	22.83	23.21
5	12	7		22.29	22.73	23.08
5	12	13		22.35	22.69	22.37
5	25	0		22.19	22.60	22.67



<For 4x4 Tx Low Band>

LTE Band 41 Maximum Average Power [dBm]						
BW [MHz]	RB Size	RB Offset	Mod	Lowest	Middle	Highest
20	1	0	QPSK	27.78	28.43	28.49
20	1	49		28.24	28.32	28.07
20	1	99		28.30	28.38	28.18
20	50	0		27.25	27.28	27.40
20	50	24		27.45	27.49	27.35
20	50	50		27.43	27.42	27.32
20	100	0		27.41	27.42	27.34
20	1	0	16-QAM	27.16	27.87	27.95
20	1	49		27.62	27.51	27.43
20	1	99		27.63	27.74	27.55
20	50	0		26.35	26.09	26.48
20	50	24		26.48	26.19	26.40
20	50	50		26.48	26.40	26.39
20	100	0		26.43	26.17	26.42
20	1	0	64-QAM	26.01	26.69	26.97
20	1	49		26.58	26.24	26.62
20	1	99		26.86	26.56	26.56
20	50	0		25.36	25.03	25.50
20	50	24		25.49	25.20	25.50
20	50	50		25.54	25.16	25.40
20	100	0		25.40	25.13	25.57
15	1	0	QPSK	27.81	28.38	28.66
15	1	37		28.33	28.50	28.48
15	1	74		28.37	28.44	28.58
15	36	0		27.26	27.41	27.38
15	36	20		27.38	27.53	27.49
15	36	39		27.51	27.51	27.46
15	75	0		27.37	27.47	27.46
15	1	0	16-QAM	27.10	27.79	28.00
15	1	37		27.61	27.69	27.82
15	1	74		27.67	27.71	27.87
15	36	0		26.23	26.07	26.42
15	36	20		26.37	26.25	26.54
15	36	39		26.54	26.27	26.42
15	75	0		26.43	26.24	26.49
15	1	0	64-QAM	25.74	26.37	27.22
15	1	37		26.23	26.60	26.83
15	1	74		26.69	26.50	26.60
15	36	0		24.92	25.22	25.68
15	36	20		25.14	25.42	25.73
15	36	39		25.18	25.39	25.57
15	75	0		25.06	25.29	25.66



LTE Band 41 Maximum Average Power [dBm]						
BW [MHz]	RB Size	RB Offset	Mod	Lowest	Middle	Highest
10	1	0	QPSK	27.55	28.05	28.13
10	1	25		28.18	28.31	28.20
10	1	49		28.56	28.61	28.56
10	25	0		27.22	27.34	27.42
10	25	12		27.34	27.41	27.46
10	25	25		27.31	27.42	27.42
10	50	0		27.25	27.44	27.40
10	1	0	16-QAM	26.96	27.49	27.52
10	1	25		27.46	27.40	27.63
10	1	49		27.89	27.94	27.89
10	25	0		26.28	26.20	26.52
10	25	12		26.29	26.30	26.26
10	25	25		26.37	26.17	26.38
10	50	0		26.30	26.27	26.40
10	1	0	64-QAM	25.43	26.57	27.27
10	1	25		26.05	26.58	26.65
10	1	49		26.54	26.86	26.70
10	25	0		24.84	25.36	25.84
10	25	12		25.08	25.49	25.67
10	25	25		25.12	25.54	25.82
10	50	0		24.92	25.40	25.70
5	1	0	QPSK	26.56	27.13	27.34
5	1	12		27.73	27.96	28.08
5	1	24		27.32	27.22	27.34
5	12	0		27.11	27.51	27.64
5	12	7		26.88	27.09	27.17
5	12	13		26.97	26.99	27.04
5	25	0		26.74	26.92	26.96
5	1	0	16-QAM	25.82	26.50	26.41
5	1	12		26.78	27.31	27.28
5	1	24		26.47	26.45	26.48
5	12	0		25.82	26.55	26.52
5	12	7		25.81	26.18	26.25
5	12	13		25.88	26.04	26.09
5	25	0		25.67	26.01	25.99
5	1	0	64-QAM	24.56	25.33	25.53
5	1	12		25.68	26.14	26.18
5	1	24		25.20	25.37	25.31
5	12	0		24.85	25.57	25.63
5	12	7		24.77	25.08	25.17
5	12	13		24.78	24.96	24.95
5	25	0		24.57	24.92	24.92



<For 4x4 Tx High Band>

LTE Band 41 Maximum Average Power [dBm]						
BW [MHz]	RB Size	RB Offset	Mod	Lowest	Middle	Highest
20	1	0	QPSK	27.72	28.09	27.97
20	1	49		27.89	27.96	27.77
20	1	99		27.97	27.77	28.23
20	50	0		27.27	26.99	26.93
20	50	24		27.44	27.04	26.85
20	50	50		27.22	27.17	27.21
20	100	0		27.30	27.05	27.05
20	1	0	16-QAM	27.37	27.40	27.50
20	1	49		27.42	27.26	27.18
20	1	99		27.43	27.17	27.64
20	50	0		26.41	26.02	25.94
20	50	24		26.50	26.10	25.99
20	50	50		26.36	26.04	26.20
20	100	0		26.37	26.03	26.08
20	1	0	64-QAM	26.83	26.89	26.70
20	1	49		26.13	26.76	26.22
20	1	99		27.02	26.83	26.95
20	50	0		25.32	25.32	25.26
20	50	24		25.19	25.44	25.16
20	50	50		25.53	25.75	25.25
20	100	0		25.24	25.54	25.30
15	1	0	QPSK	28.11	27.90	27.86
15	1	37		28.30	27.95	27.78
15	1	74		28.06	27.84	28.06
15	36	0		27.13	26.97	26.81
15	36	20		27.44	27.04	27.07
15	36	39		27.30	27.05	27.17
15	75	0		27.35	27.05	27.06
15	1	0	16-QAM	27.51	27.12	27.26
15	1	37		27.61	27.20	27.21
15	1	74		27.40	27.15	27.37
15	36	0		26.27	25.87	25.86
15	36	20		26.44	26.01	26.10
15	36	39		26.35	26.04	26.24
15	75	0		26.43	26.06	26.17
15	1	0	64-QAM	26.60	26.54	26.26
15	1	37		26.81	26.74	25.96
15	1	74		26.83	27.01	26.49
15	36	0		25.51	24.99	24.98
15	36	20		25.65	25.26	25.06
15	36	39		25.66	25.44	25.29
15	75	0		25.80	25.20	25.18



LTE Band 41 Maximum Average Power [dBm]						
BW [MHz]	RB Size	RB Offset	Mod	Lowest	Middle	Highest
10	1	0	QPSK	28.08	28.06	27.82
10	1	25		27.85	27.85	27.87
10	1	49		28.28	27.96	28.18
10	25	0		27.26	26.91	27.00
10	25	12		27.24	27.14	27.12
10	25	25		27.34	27.12	27.28
10	50	0		27.29	26.96	27.14
10	1	0	16-QAM	27.53	27.26	27.05
10	1	25		27.18	27.17	27.19
10	1	49		27.62	27.27	27.53
10	25	0		26.26	26.02	26.06
10	25	12		26.25	26.14	26.13
10	25	25		26.39	26.17	26.29
10	50	0		26.37	26.02	26.09
10	1	0	64-QAM	26.75	26.85	26.42
10	1	25		26.69	26.13	25.96
10	1	49		26.78	27.02	27.20
10	25	0		25.82	25.32	25.27
10	25	12		25.86	25.19	25.24
10	25	25		25.79	25.53	25.58
10	50	0		25.80	25.24	25.44
5	1	0	QPSK	27.07	26.86	26.93
5	1	12		27.70	27.74	27.79
5	1	24		26.90	27.11	27.24
5	12	0		27.45	27.14	27.36
5	12	7		27.12	27.00	27.19
5	12	13		26.95	26.96	27.15
5	25	0		26.97	26.87	27.01
5	1	0	16-QAM	26.53	26.16	26.22
5	1	12		27.11	27.05	27.05
5	1	24		26.34	26.48	26.65
5	12	0		26.63	26.25	26.24
5	12	7		26.31	26.00	26.03
5	12	13		26.19	25.95	26.02
5	25	0		26.23	25.87	25.89
5	1	0	64-QAM	25.92	25.35	25.18
5	1	12		26.40	26.15	25.94
5	1	24		25.53	25.65	25.94
5	12	0		26.10	25.58	25.28
5	12	7		25.62	25.14	25.23
5	12	13		25.42	24.95	25.24
5	25	0		25.53	25.00	25.18



<Contiguous for TX Low Band Chain 1>

LTE Band 41_CA Low Band Tx0 Maximum Average Power [dBm]								
BW [MHz]	PCC		SCC		Mod	Lowest	Middle	Highest
	RB Size	RB Offset	RB Size	RB Offset				
20+20	100	0	100	0	QPSK	24.56	24.62	24.88
20+20	1	0	1	99		25.06	25.94	25.41
20+20	1	99	1	0		25.82	25.78	26.08
20+20	100	0	100	0	16-QAM	23.50	23.60	23.99
20+20	1	0	1	99		24.38	25.11	24.83
20+20	1	99	1	0		25.02	24.99	25.30
20+20	100	0	100	0	64-QAM	22.67	22.65	22.80
20+20	1	0	1	99		23.49	23.97	23.63
20+20	1	99	1	0		24.08	23.93	23.93
20+15	100	0	75	0	QPSK	24.64	24.68	24.97
20+15	1	0	1	74		25.23	25.99	25.93
20+15	1	99	1	0		25.83	26.06	26.00
20+15	100	0	75	0	16-QAM	23.69	23.74	24.02
20+15	1	0	1	74		24.58	25.19	25.25
20+15	1	99	1	0		25.16	25.31	25.35
20+15	100	0	75	0	64-QAM	22.79	22.67	22.87
20+15	1	0	1	74		23.46	23.93	23.73
20+15	1	99	1	0		24.12	24.02	24.34
15+20	75	0	100	0	QPSK	24.81	24.68	25.20
15+20	1	0	1	99		25.36	25.97	25.80
15+20	1	74	1	0		26.14	25.91	26.30
15+20	75	0	100	0	16-QAM	23.87	23.75	24.14
15+20	1	0	1	99		24.61	25.15	25.05
15+20	1	74	1	0		25.34	25.07	25.47
15+20	75	0	100	0	64-QAM	22.55	22.84	22.83
15+20	1	0	1	99		23.53	24.04	23.62
15+20	1	74	1	0		23.54	23.92	23.92



LTE Band 41_CA Low Band Tx0 Maximum Average Power [dBm]								
BW [MHz]	PCC		SCC		Mod	Lowest	Middle	Highest
	RB Size	RB Offset	RB Size	RB Offset				
20+10	100	0	50	0	QPSK	24.63	24.62	25.30
20+10	1	0	1	49		25.18	25.90	26.16
20+10	1	99	1	0		25.79	25.98	25.96
20+10	100	0	50	0	16-QAM	23.63	23.59	24.38
20+10	1	0	1	49		24.46	25.14	25.37
20+10	1	99	1	0		25.06	25.11	25.27
20+10	100	0	50	0	64-QAM	22.74	22.49	22.71
20+10	1	0	1	49		23.39	24.02	23.38
20+10	1	99	1	0		23.98	23.64	24.19
10+20	50	0	100	0	QPSK	24.58	24.32	25.17
10+20	1	0	1	99		25.25	25.91	25.64
10+20	1	49	1	0		25.99	25.84	26.23
10+20	50	0	100	0	16-QAM	23.62	23.81	24.20
10+20	1	0	1	99		24.53	25.10	24.86
10+20	1	49	1	0		25.18	25.11	25.49
10+20	50	0	100	0	64-QAM	22.54	22.72	22.70
10+20	1	0	1	99		23.47	24.02	23.34
10+20	1	49	1	0		23.65	24.05	23.97
20+5	100	0	25	0	QPSK	24.53	24.59	25.44
20+5	1	0	1	24		24.58	25.79	26.26
20+5	1	99	1	0		25.27	25.99	25.82
20+5	100	0	25	0	16-QAM	23.54	23.87	24.41
20+5	1	0	1	24		23.83	25.05	25.62
20+5	1	99	1	0		24.49	25.27	25.22
20+5	100	0	25	0	64-QAM	22.88	22.47	22.85
20+5	1	0	1	24		22.87	23.15	23.09
20+5	1	99	1	0		23.52	22.94	23.54
5+20	25	0	100	0	QPSK	24.21	24.70	25.15
5+20	1	0	1	99		25.10	25.37	25.42
5+20	1	24	1	0		25.29	25.50	25.91
5+20	25	0	100	0	16-QAM	23.31	23.77	24.22
5+20	1	0	1	99		24.29	24.58	24.76
5+20	1	24	1	0		24.43	24.76	25.11
5+20	25	0	100	0	64-QAM	22.39	22.82	22.67
5+20	1	0	1	99		23.13	23.15	22.94
5+20	1	24	1	0		23.10	23.44	23.41



LTE Band 41_CA Low Band Tx0 Maximum Average Power [dBm]								
BW [MHz]	PCC		SCC		Mod	Lowest	Middle	Highest
	RB Size	RB Offset	RB Size	RB Offset				
15+10	75	0	50	0	QPSK	24.72	24.60	25.38
15+10	1	0	1	49		25.34	25.80	26.27
15+10	1	74	1	0		26.11	26.01	25.94
15+10	75	0	50	0	16-QAM	23.82	23.75	24.49
15+10	1	0	1	49		24.74	24.99	25.58
15+10	1	74	1	0		25.29	25.25	25.26
15+10	75	0	50	0	64-QAM	22.74	22.75	22.89
15+10	1	0	1	49		23.48	23.82	23.49
15+10	1	74	1	0		23.49	23.94	24.39
10+15	50	0	75	0	QPSK	24.57	24.56	25.07
10+15	1	49	1	0		25.31	25.81	26.09
10+15	1	0	1	74		26.01	25.86	26.00
10+15	50	0	75	0	16-QAM	23.64	23.73	24.15
10+15	1	49	1	0		24.69	25.00	25.41
10+15	1	0	1	74		25.15	25.06	25.35
10+15	50	0	75	0	64-QAM	22.53	22.69	22.94
10+15	1	49	1	0		23.49	23.76	23.44
10+15	1	0	1	74		23.64	23.95	24.24
15+15	75	0	75	0	QPSK	24.87	24.73	25.07
15+15	1	0	1	74		25.35	26.06	26.04
15+15	1	74	1	0		26.13	25.96	26.09
15+15	75	0	75	0	16-QAM	23.92	23.74	24.08
15+15	1	0	1	74		24.68	25.25	25.27
15+15	1	74	1	0		25.42	25.27	25.39
15+15	75	0	75	0	64-QAM	22.69	22.81	22.87
15+15	1	0	1	74		23.49	24.14	23.45
15+15	1	74	1	0		24.07	24.00	24.31



<Contiguous for TX Low Band Chain 2>

LTE Band 41_CA Low Band Tx1 Maximum Average Power [dBm]								
BW [MHz]	PCC		SCC		Mod	Lowest	Middle	Highest
	RB Size	RB Offset	RB Size	RB Offset				
20+20	100	0	100	0	QPSK	24.42	24.67	24.10
20+20	1	0	1	99		25.53	25.46	26.09
20+20	1	99	1	0		25.43	25.92	25.63
20+20	100	0	100	0	16-QAM	23.44	23.60	23.63
20+20	1	0	1	99		24.83	24.73	25.33
20+20	1	99	1	0		24.78	25.17	24.84
20+20	100	0	100	0	64-QAM	22.73	22.75	22.87
20+20	1	0	1	99		23.63	23.68	24.22
20+20	1	99	1	0		24.07	24.27	23.59
20+15	100	0	75	0	QPSK	24.51	24.20	24.82
20+15	1	0	1	74		25.53	25.69	26.01
20+15	1	99	1	0		25.47	26.07	25.85
20+15	100	0	75	0	16-QAM	23.60	23.72	23.90
20+15	1	0	1	74		24.73	24.78	25.39
20+15	1	99	1	0		24.90	25.43	25.11
20+15	100	0	75	0	64-QAM	22.77	22.66	22.95
20+15	1	0	1	74		23.72	23.65	24.13
20+15	1	99	1	0		23.89	24.23	23.96
15+20	75	0	100	0	QPSK	24.67	24.74	24.59
15+20	1	0	1	99		25.68	25.76	26.13
15+20	1	74	1	0		25.52	26.04	25.69
15+20	75	0	100	0	16-QAM	23.71	23.89	23.65
15+20	1	0	1	99		24.93	24.77	25.39
15+20	1	74	1	0		24.76	25.33	24.73
15+20	75	0	100	0	64-QAM	22.66	22.86	22.87
15+20	1	0	1	99		23.78	23.62	24.27
15+20	1	74	1	0		23.69	24.15	23.62



LTE Band 41_CA Low Band Tx1 Maximum Average Power [dBm]								
BW [MHz]	PCC		SCC		Mod	Lowest	Middle	Highest
	RB Size	RB Offset	RB Size	RB Offset				
20+10	100	0	50	0	QPSK	24.41	24.63	24.79
20+10	1	0	1	49		25.51	25.62	25.87
20+10	1	99	1	0		25.45	25.91	25.84
20+10	100	0	50	0	16-QAM	23.43	23.72	23.84
20+10	1	0	1	49		24.78	24.91	25.20
20+10	1	99	1	0		24.81	25.16	25.11
20+10	100	0	50	0	64-QAM	22.72	22.79	22.82
20+10	1	0	1	49		23.79	23.84	23.96
20+10	1	99	1	0		23.81	24.07	24.05
10+20	50	0	100	0	QPSK	24.62	24.75	24.59
10+20	1	0	1	99		25.56	25.66	25.82
10+20	1	49	1	0		25.64	25.93	25.61
10+20	50	0	100	0	16-QAM	23.62	23.84	23.52
10+20	1	0	1	99		24.75	24.94	25.07
10+20	1	49	1	0		24.88	25.18	24.66
10+20	50	0	100	0	64-QAM	22.64	22.97	22.71
10+20	1	0	1	99		23.74	23.85	23.98
10+20	1	49	1	0		23.72	24.07	23.51
20+5	100	0	25	0	QPSK	24.41	24.64	24.80
20+5	1	0	1	24		24.87	25.30	25.32
20+5	1	99	1	0		25.02	25.25	25.65
20+5	100	0	25	0	16-QAM	23.42	23.87	23.82
20+5	1	0	1	24		24.05	24.53	24.53
20+5	1	99	1	0		24.36	24.48	24.92
20+5	100	0	25	0	64-QAM	22.61	22.96	22.86
20+5	1	0	1	24		23.15	23.41	23.45
20+5	1	99	1	0		23.27	23.46	23.75
5+20	25	0	100	0	QPSK	24.45	24.78	24.43
5+20	1	0	1	99		25.09	25.11	25.42
5+20	1	24	1	0		25.34	25.17	25.08
5+20	25	0	100	0	16-QAM	23.45	24.39	23.43
5+20	1	0	1	99		24.42	25.09	24.63
5+20	1	24	1	0		24.64	25.06	24.19
5+20	25	0	100	0	64-QAM	22.45	23.07	22.52
5+20	1	0	1	99		23.19	23.37	23.49
5+20	1	24	1	0		23.42	23.69	23.08



LTE Band 41_CA Low Band Tx1 Maximum Average Power [dBm]								
BW [MHz]	PCC		SCC		Mod	Lowest	Middle	Highest
	RB Size	RB Offset	RB Size	RB Offset				
15+10	75	0	50	0	QPSK	24.67	24.78	25.29
15+10	1	0	1	49		25.52	25.80	26.09
15+10	1	74	1	0		25.43	25.98	25.91
15+10	75	0	50	0	16-QAM	23.62	23.97	24.43
15+10	1	0	1	49		24.84	25.11	25.53
15+10	1	74	1	0		24.69	25.30	25.24
15+10	75	0	50	0	64-QAM	22.77	23.03	23.45
15+10	1	0	1	49		23.74	24.06	24.48
15+10	1	74	1	0		23.55	24.02	24.45
10+15	50	0	75	0	QPSK	25.04	24.66	24.77
10+15	1	49	1	0		25.94	25.61	25.85
10+15	1	0	1	74		25.80	26.33	25.82
10+15	50	0	75	0	16-QAM	24.15	25.03	23.86
10+15	1	49	1	0		25.39	24.85	25.15
10+15	1	0	1	74		24.95	25.85	25.13
10+15	50	0	75	0	64-QAM	23.16	23.95	22.80
10+15	1	49	1	0		24.30	23.74	23.93
10+15	1	0	1	74		23.74	24.65	23.96
15+15	75	0	75	0	QPSK	25.17	24.97	24.88
15+15	1	0	1	74		25.78	26.10	25.99
15+15	1	74	1	0		25.87	26.11	25.84
15+15	75	0	75	0	16-QAM	24.16	24.11	23.92
15+15	1	0	1	74		25.11	25.30	25.33
15+15	1	74	1	0		25.21	25.44	25.09
15+15	75	0	75	0	64-QAM	23.18	23.06	22.76
15+15	1	0	1	74		23.85	24.21	24.08
15+15	1	74	1	0		24.07	24.24	23.97



<Contiguous for TX Low Band Chain 1+2>

LTE Band 41_CA Low Band Combin Maximum Average Power [dBm]								
BW [MHz]	PCC		SCC		Mod	Lowest	Middle	Highest
	RB Size	RB Offset	RB Size	RB Offset				
20+20	100	0	100	0	QPSK	27.48	27.49	27.33
20+20	1	0	1	99		28.60	28.65	28.66
20+20	1	99	1	0		28.64	28.58	28.45
20+20	100	0	100	0	16-QAM	26.62	26.78	26.34
20+20	1	0	1	99		27.85	28.04	27.96
20+20	1	99	1	0		27.89	27.79	27.85
20+20	100	0	100	0	64-QAM	25.93	25.58	25.47
20+20	1	0	1	99		26.93	27.10	26.90
20+20	1	99	1	0		27.09	26.78	26.84
20+15	100	0	75	0	QPSK	27.48	27.70	27.56
20+15	1	0	1	74		28.49	28.78	28.72
20+15	1	99	1	0		28.81	28.69	28.38
20+15	100	0	75	0	16-QAM	26.65	26.80	26.50
20+15	1	0	1	74		27.78	27.98	27.97
20+15	1	99	1	0		28.15	27.88	27.66
20+15	100	0	75	0	64-QAM	25.93	25.75	25.56
20+15	1	0	1	74		26.93	26.89	27.04
20+15	1	99	1	0		27.02	26.84	26.56
15+20	75	0	100	0	QPSK	27.95	27.51	27.61
15+20	1	0	1	99		28.56	28.93	28.72
15+20	1	74	1	0		29.04	28.49	28.72
15+20	75	0	100	0	16-QAM	26.92	26.58	26.51
15+20	1	0	1	99		27.87	28.33	28.03
15+20	1	74	1	0		28.44	27.67	27.99
15+20	75	0	100	0	64-QAM	26.02	25.68	25.50
15+20	1	0	1	99		27.05	27.29	26.94
15+20	1	74	1	0		27.30	27.01	26.92



LTE Band 41_CA Low Band Combin Maximum Average Power [dBm]								
BW [MHz]	PCC		SCC		Mod	Lowest	Middle	Highest
	RB Size	RB Offset	RB Size	RB Offset				
20+10	100	0	50	0	QPSK	27.54	27.62	27.15
20+10	1	0	1	49		28.37	28.80	28.80
20+10	1	99	1	0		28.79	28.57	28.41
20+10	100	0	50	0	16-QAM	26.71	26.64	26.27
20+10	1	0	1	49		27.67	27.98	28.00
20+10	1	99	1	0		28.12	27.81	27.71
20+10	100	0	50	0	64-QAM	25.95	25.57	25.38
20+10	1	0	1	49		26.83	26.88	26.79
20+10	1	99	1	0		27.03	26.84	26.57
10+20	50	0	100	0	QPSK	27.98	27.45	27.54
10+20	1	0	1	99		28.44	28.81	28.71
10+20	1	49	1	0		29.13	28.39	28.68
10+20	50	0	100	0	16-QAM	27.07	26.52	26.48
10+20	1	0	1	99		27.70	28.02	27.95
10+20	1	49	1	0		28.46	27.58	27.90
10+20	50	0	100	0	64-QAM	26.09	25.59	25.47
10+20	1	0	1	99		26.86	26.86	26.88
10+20	1	49	1	0		27.32	26.55	26.81
20+5	100	0	25	0	QPSK	27.62	27.55	27.25
20+5	1	0	1	24		28.29	28.32	28.08
20+5	1	99	1	0		28.29	28.19	28.02
20+5	100	0	25	0	16-QAM	26.78	26.57	26.28
20+5	1	0	1	24		27.52	27.58	27.40
20+5	1	99	1	0		27.66	27.42	27.09
20+5	100	0	25	0	64-QAM	25.96	25.56	25.37
20+5	1	0	1	24		26.46	26.25	26.32
20+5	1	99	1	0		26.46	26.34	25.96
5+20	25	0	100	0	QPSK	28.06	27.73	27.54
5+20	1	0	1	99		28.11	28.12	28.30
5+20	1	24	1	0		28.22	27.90	28.22
5+20	25	0	100	0	16-QAM	27.04	26.62	26.46
5+20	1	0	1	99		27.43	27.25	27.64
5+20	1	24	1	0		27.56	26.99	27.53
5+20	25	0	100	0	64-QAM	26.03	25.56	25.39
5+20	1	0	1	99		26.60	26.25	26.33
5+20	1	24	1	0		26.78	26.11	26.20



LTE Band 41_CA Low Band Combin Maximum Average Power [dBm]								
BW [MHz]	PCC		SCC		Mod	Lowest	Middle	Highest
	RB Size	RB Offset	RB Size	RB Offset				
15+10	75	0	50	0	QPSK	28.04	27.51	27.23
15+10	1	0	1	49		28.89	28.76	28.91
15+10	1	74	1	0		29.05	28.67	28.40
15+10	75	0	50	0	16-QAM	27.15	26.55	26.35
15+10	1	0	1	49		28.17	27.89	27.99
15+10	1	74	1	0		28.37	27.95	27.68
15+10	75	0	50	0	64-QAM	26.02	25.96	25.39
15+10	1	0	1	49		27.08	26.86	26.77
15+10	1	74	1	0		27.18	26.72	26.53
10+15	50	0	75	0	QPSK	28.03	27.39	27.45
10+15	1	49	1	0		28.83	28.70	28.78
10+15	1	0	1	74		29.09	28.37	28.59
10+15	50	0	75	0	16-QAM	27.20	26.38	26.38
10+15	1	49	1	0		28.11	27.93	27.91
10+15	1	0	1	74		28.47	27.58	27.83
10+15	50	0	75	0	64-QAM	26.12	25.60	25.41
10+15	1	49	1	0		27.04	26.69	26.90
10+15	1	0	1	74		27.34	26.59	26.70
15+15	75	0	75	0	QPSK	27.93	27.56	27.50
15+15	1	0	1	74		28.56	28.88	28.89
15+15	1	74	1	0		29.07	28.61	28.62
15+15	75	0	75	0	16-QAM	27.06	26.63	26.44
15+15	1	0	1	74		27.81	28.13	28.02
15+15	1	74	1	0		28.38	27.77	27.88
15+15	75	0	75	0	64-QAM	26.07	25.74	25.51
15+15	1	0	1	74		26.96	26.97	27.03
15+15	1	74	1	0		27.34	26.78	26.78



<Contiguous for TX High Band Chain 1>

LTE Band 41_CA High Band Tx0 Maximum Average Power [dBm]								
BW [MHz]	PCC		SCC		Mod	Lowest	Middle	Highest
	RB Size	RB Offset	RB Size	RB Offset				
20+20	100	0	100	0	QPSK	24.40	24.54	24.24
20+20	1	0	1	99		25.77	25.87	25.81
20+20	1	99	1	0		25.56	25.80	25.49
20+20	100	0	100	0	16-QAM	23.62	23.55	23.38
20+20	1	0	1	99		24.97	25.24	25.12
20+20	1	99	1	0		24.82	25.00	24.86
20+20	100	0	100	0	64-QAM	22.86	22.57	22.43
20+20	1	0	1	99		24.10	24.05	23.99
20+20	1	99	1	0		23.94	23.90	23.76
20+15	100	0	75	0	QPSK	24.42	24.77	24.55
20+15	1	0	1	74		25.58	25.75	25.71
20+15	1	99	1	0		25.71	25.86	25.48
20+15	100	0	75	0	16-QAM	23.68	23.82	23.34
20+15	1	0	1	74		24.81	24.94	24.98
20+15	1	99	1	0		25.02	25.05	24.79
20+15	100	0	75	0	64-QAM	22.91	22.63	22.41
20+15	1	0	1	74		24.09	23.78	24.12
20+15	1	99	1	0		23.92	24.05	23.67
15+20	75	0	100	0	QPSK	24.99	24.54	24.63
15+20	1	0	1	99		25.73	25.86	25.84
15+20	1	74	1	0		25.93	25.66	25.69
15+20	75	0	100	0	16-QAM	23.93	23.53	23.57
15+20	1	0	1	99		25.06	25.05	25.22
15+20	1	74	1	0		25.42	24.86	24.97
15+20	75	0	100	0	64-QAM	22.93	22.64	22.45
15+20	1	0	1	99		24.24	23.86	24.03
15+20	1	74	1	0		24.15	23.96	23.77



LTE Band 41_CA High Band Tx0 Maximum Average Power [dBm]								
BW [MHz]	PCC		SCC		Mod	Lowest	Middle	Highest
	RB Size	RB Offset	RB Size	RB Offset				
20+10	100	0	50	0	QPSK	24.42	24.73	23.92
20+10	1	0	1	49		25.44	25.75	25.77
20+10	1	99	1	0		25.76	25.62	25.52
20+10	100	0	50	0	16-QAM	23.67	23.77	23.19
20+10	1	0	1	49		24.70	24.94	25.06
20+10	1	99	1	0		25.06	24.90	24.89
20+10	100	0	50	0	64-QAM	22.84	22.55	22.25
20+10	1	0	1	49		24.01	23.79	24.00
20+10	1	99	1	0		23.83	23.98	23.40
10+20	50	0	100	0	QPSK	25.07	24.48	24.48
10+20	1	0	1	99		25.64	25.75	25.84
10+20	1	49	1	0		26.08	25.55	25.68
10+20	50	0	100	0	16-QAM	24.14	23.51	23.55
10+20	1	0	1	99		24.89	24.93	25.06
10+20	1	49	1	0		25.43	24.73	24.89
10+20	50	0	100	0	64-QAM	22.89	22.52	22.37
10+20	1	0	1	99		23.93	23.66	23.95
10+20	1	49	1	0		24.24	23.81	23.70
20+5	100	0	25	0	QPSK	24.43	24.68	24.29
20+5	1	0	1	24		25.35	25.39	24.81
20+5	1	99	1	0		25.29	25.19	25.37
20+5	100	0	25	0	16-QAM	23.65	23.71	23.28
20+5	1	0	1	24		24.56	24.64	24.32
20+5	1	99	1	0		24.64	24.45	24.36
20+5	100	0	25	0	64-QAM	22.75	22.56	22.36
20+5	1	0	1	24		23.47	23.17	23.26
20+5	1	99	1	0		23.29	23.32	23.15
5+20	25	0	100	0	QPSK	25.21	25.05	24.57
5+20	1	0	1	99		25.04	24.85	25.39
5+20	1	24	1	0		25.23	25.13	25.35
5+20	25	0	100	0	16-QAM	24.11	23.82	23.57
5+20	1	0	1	99		24.29	24.08	24.82
5+20	1	24	1	0		24.47	24.21	24.64
5+20	25	0	100	0	64-QAM	22.97	22.63	22.30
5+20	1	0	1	99		23.58	23.14	23.29
5+20	1	24	1	0		23.85	23.18	23.06



LTE Band 41_CA High Band Tx0 Maximum Average Power [dBm]								
BW [MHz]	PCC		SCC		Mod	Lowest	Middle	Highest
	RB Size	RB Offset	RB Size	RB Offset				
15+10	75	0	50	0	QPSK	25.09	24.61	24.01
15+10	1	0	1	49		26.07	25.71	25.90
15+10	1	74	1	0		25.99	25.88	25.43
15+10	75	0	50	0	16-QAM	24.17	23.65	23.21
15+10	1	0	1	49		25.38	24.86	24.98
15+10	1	74	1	0		25.36	25.20	24.76
15+10	75	0	50	0	64-QAM	22.80	23.22	22.29
15+10	1	0	1	49		24.06	23.77	23.92
15+10	1	74	1	0		24.11	23.86	23.29
10+15	50	0	75	0	QPSK	25.10	24.49	24.37
10+15	1	49	1	0		25.97	25.60	25.78
10+15	1	0	1	74		26.06	25.58	25.69
10+15	50	0	75	0	16-QAM	24.25	23.44	23.27
10+15	1	49	1	0		25.30	24.88	24.90
10+15	1	0	1	74		25.45	24.82	24.77
10+15	50	0	75	0	64-QAM	23.03	22.57	22.36
10+15	1	49	1	0		23.99	23.59	23.96
10+15	1	0	1	74		24.29	23.90	23.62
15+15	75	0	75	0	QPSK	24.98	24.56	24.46
15+15	1	0	1	74		25.76	25.71	25.99
15+15	1	74	1	0		25.98	25.78	25.59
15+15	75	0	75	0	16-QAM	24.04	23.64	23.38
15+15	1	0	1	74		25.05	25.01	25.06
15+15	1	74	1	0		25.26	24.96	24.83
15+15	75	0	75	0	64-QAM	22.91	22.66	22.46
15+15	1	0	1	74		24.13	23.81	24.11
15+15	1	74	1	0		24.18	23.99	23.69



<Contiguous for TX High Band Chain 2>

LTE Band 41_CA High Band Tx1 Maximum Average Power [dBm]								
BW [MHz]	PCC		SCC		Mod	Lowest	Middle	Highest
	RB Size	RB Offset	RB Size	RB Offset				
20+20	100	0	100	0	QPSK	24.53	24.42	24.40
20+20	1	0	1	99		25.41	25.40	25.49
20+20	1	99	1	0		25.69	25.33	25.38
20+20	100	0	100	0	16-QAM	23.60	23.98	23.27
20+20	1	0	1	99		24.71	24.80	24.77
20+20	1	99	1	0		24.93	24.54	24.81
20+20	100	0	100	0	64-QAM	22.97	22.56	22.48
20+20	1	0	1	99		23.74	24.12	23.78
20+20	1	99	1	0		24.22	23.64	23.89
20+15	100	0	75	0	QPSK	24.51	24.60	24.55
20+15	1	0	1	74		25.37	25.78	25.70
20+15	1	99	1	0		25.88	25.49	25.25
20+15	100	0	75	0	16-QAM	23.59	23.76	23.63
20+15	1	0	1	74		24.73	25.00	24.93
20+15	1	99	1	0		25.26	24.68	24.50
20+15	100	0	75	0	64-QAM	22.93	22.84	22.69
20+15	1	0	1	74		23.74	23.98	23.94
20+15	1	99	1	0		24.10	23.60	23.42
15+20	75	0	100	0	QPSK	24.88	24.45	24.56
15+20	1	0	1	99		25.37	25.98	25.57
15+20	1	74	1	0		26.13	25.30	25.73
15+20	75	0	100	0	16-QAM	23.89	23.60	23.43
15+20	1	0	1	99		24.64	25.58	24.82
15+20	1	74	1	0		25.44	24.46	24.98
15+20	75	0	100	0	64-QAM	23.09	22.70	22.52
15+20	1	0	1	99		23.84	24.66	23.82
15+20	1	74	1	0		24.43	24.03	24.05



LTE Band 41_CA High Band Tx1 Maximum Average Power [dBm]								
BW [MHz]	PCC		SCC		Mod	Lowest	Middle	Highest
	RB Size	RB Offset	RB Size	RB Offset				
20+10	100	0	50	0	QPSK	24.63	24.48	24.35
20+10	1	0	1	49		25.28	25.83	25.80
20+10	1	99	1	0		25.80	25.50	25.27
20+10	100	0	50	0	16-QAM	23.72	23.48	23.32
20+10	1	0	1	49		24.62	25.00	24.91
20+10	1	99	1	0		25.15	24.70	24.50
20+10	100	0	50	0	64-QAM	23.03	22.56	22.48
20+10	1	0	1	49		23.63	23.95	23.55
20+10	1	99	1	0		24.21	23.68	23.72
10+20	50	0	100	0	QPSK	24.86	24.39	24.57
10+20	1	0	1	99		25.21	25.85	25.55
10+20	1	49	1	0		26.15	25.20	25.66
10+20	50	0	100	0	16-QAM	23.98	23.51	23.38
10+20	1	0	1	99		24.48	25.09	24.81
10+20	1	49	1	0		25.46	24.41	24.88
10+20	50	0	100	0	64-QAM	23.27	22.63	22.54
10+20	1	0	1	99		23.76	24.03	23.78
10+20	1	49	1	0		24.38	23.25	23.90
20+5	100	0	25	0	QPSK	24.78	24.40	24.19
20+5	1	0	1	24		25.20	25.23	25.31
20+5	1	99	1	0		25.26	25.17	24.62
20+5	100	0	25	0	16-QAM	23.88	23.40	23.25
20+5	1	0	1	24		24.46	24.50	24.45
20+5	1	99	1	0		24.65	24.36	23.78
20+5	100	0	25	0	64-QAM	23.15	22.53	22.35
20+5	1	0	1	24		23.42	23.30	23.36
20+5	1	99	1	0		23.61	23.34	22.74
5+20	25	0	100	0	QPSK	24.89	24.37	24.48
5+20	1	0	1	99		25.16	25.36	25.18
5+20	1	24	1	0		25.19	24.64	25.07
5+20	25	0	100	0	16-QAM	23.94	23.39	23.32
5+20	1	0	1	99		24.55	24.40	24.44
5+20	1	24	1	0		24.62	23.74	24.39
5+20	25	0	100	0	64-QAM	23.07	22.46	22.45
5+20	1	0	1	99		23.60	23.33	23.35
5+20	1	24	1	0		23.68	23.01	23.31



LTE Band 41_CA High Band Tx1 Maximum Average Power [dBm]								
BW [MHz]	PCC		SCC		Mod	Lowest	Middle	Highest
	RB Size	RB Offset	RB Size	RB Offset				
15+10	75	0	50	0	QPSK	24.97	24.39	24.42
15+10	1	0	1	49		25.68	25.79	25.89
15+10	1	74	1	0		26.08	25.42	25.34
15+10	75	0	50	0	16-QAM	24.10	23.43	23.46
15+10	1	0	1	49		24.92	24.90	24.97
15+10	1	74	1	0		25.35	24.67	24.58
15+10	75	0	50	0	64-QAM	23.21	22.66	22.47
15+10	1	0	1	49		24.08	23.93	23.59
15+10	1	74	1	0		24.23	23.56	23.74
10+15	50	0	75	0	QPSK	24.94	24.27	24.51
10+15	1	49	1	0		25.66	25.78	25.76
10+15	1	0	1	74		26.10	25.13	25.47
10+15	50	0	75	0	16-QAM	24.13	23.29	23.47
10+15	1	49	1	0		24.89	24.96	24.90
10+15	1	0	1	74		25.46	24.30	24.87
10+15	50	0	75	0	64-QAM	23.19	22.61	22.43
10+15	1	49	1	0		24.06	23.77	23.82
10+15	1	0	1	74		24.37	23.24	23.75
15+15	75	0	75	0	QPSK	24.86	24.54	24.51
15+15	1	0	1	74		25.33	26.03	25.77
15+15	1	74	1	0		26.13	25.41	25.62
15+15	75	0	75	0	16-QAM	24.06	23.59	23.47
15+15	1	0	1	74		24.53	25.23	24.96
15+15	1	74	1	0		25.48	24.54	24.90
15+15	75	0	75	0	64-QAM	23.21	22.79	22.53
15+15	1	0	1	74		23.77	24.11	23.92
15+15	1	74	1	0		24.48	23.54	23.84



<Contiguous for TX High Band Chain 1+2>

LTE Band 41_CA High Band Combin Maximum Average Power [dBm]								
BW [MHz]	PCC		SCC		Mod	Lowest	Middle	Highest
	RB Size	RB Offset	RB Size	RB Offset				
20+20	100	0	100	0	QPSK	27.48	27.49	27.33
20+20	1	0	1	99		28.60	28.65	28.66
20+20	1	99	1	0		28.64	28.58	28.45
20+20	100	0	100	0	16-QAM	26.62	26.78	26.34
20+20	1	0	1	99		27.85	28.04	27.96
20+20	1	99	1	0		27.89	27.79	27.85
20+20	100	0	100	0	64-QAM	25.93	25.58	25.47
20+20	1	0	1	99		26.93	27.10	26.90
20+20	1	99	1	0		27.09	26.78	26.84
20+15	100	0	75	0	QPSK	27.48	27.70	27.56
20+15	1	0	1	74		28.49	28.78	28.72
20+15	1	99	1	0		28.81	28.69	28.38
20+15	100	0	75	0	16-QAM	26.65	26.80	26.50
20+15	1	0	1	74		27.78	27.98	27.97
20+15	1	99	1	0		28.15	27.88	27.66
20+15	100	0	75	0	64-QAM	25.93	25.75	25.56
20+15	1	0	1	74		26.93	26.89	27.04
20+15	1	99	1	0		27.02	26.84	26.56
15+20	75	0	100	0	QPSK	27.95	27.51	27.61
15+20	1	0	1	99		28.56	28.93	28.72
15+20	1	74	1	0		29.04	28.49	28.72
15+20	75	0	100	0	16-QAM	26.92	26.58	26.51
15+20	1	0	1	99		27.87	28.33	28.03
15+20	1	74	1	0		28.44	27.67	27.99
15+20	75	0	100	0	64-QAM	26.02	25.68	25.50
15+20	1	0	1	99		27.05	27.29	26.94
15+20	1	74	1	0		27.30	27.01	26.92



LTE Band 41_CA High Band Combin Maximum Average Power [dBm]								
BW [MHz]	PCC		SCC		Mod	Lowest	Middle	Highest
	RB Size	RB Offset	RB Size	RB Offset				
20+10	100	0	50	0	QPSK	27.54	27.62	27.15
20+10	1	0	1	49		28.37	28.80	28.80
20+10	1	99	1	0		28.79	28.57	28.41
20+10	100	0	50	0	16-QAM	26.71	26.64	26.27
20+10	1	0	1	49		27.67	27.98	28.00
20+10	1	99	1	0		28.12	27.81	27.71
20+10	100	0	50	0	64-QAM	25.95	25.57	25.38
20+10	1	0	1	49		26.83	26.88	26.79
20+10	1	99	1	0		27.03	26.84	26.57
10+20	50	0	100	0	QPSK	27.98	27.45	27.54
10+20	1	0	1	99		28.44	28.81	28.71
10+20	1	49	1	0		29.13	28.39	28.68
10+20	50	0	100	0	16-QAM	27.07	26.52	26.48
10+20	1	0	1	99		27.70	28.02	27.95
10+20	1	49	1	0		28.46	27.58	27.90
10+20	50	0	100	0	64-QAM	26.09	25.59	25.47
10+20	1	0	1	99		26.86	26.86	26.88
10+20	1	49	1	0		27.32	26.55	26.81
20+5	100	0	25	0	QPSK	27.62	27.55	27.25
20+5	1	0	1	24		28.29	28.32	28.08
20+5	1	99	1	0		28.29	28.19	28.02
20+5	100	0	25	0	16-QAM	26.78	26.57	26.28
20+5	1	0	1	24		27.52	27.58	27.40
20+5	1	99	1	0		27.66	27.42	27.09
20+5	100	0	25	0	64-QAM	25.96	25.56	25.37
20+5	1	0	1	24		26.46	26.25	26.32
20+5	1	99	1	0		26.46	26.34	25.96
5+20	25	0	100	0	QPSK	28.06	27.73	27.54
5+20	1	0	1	99		28.11	28.12	28.30
5+20	1	24	1	0		28.22	27.90	28.22
5+20	25	0	100	0	16-QAM	27.04	26.62	26.46
5+20	1	0	1	99		27.43	27.25	27.64
5+20	1	24	1	0		27.56	26.99	27.53
5+20	25	0	100	0	64-QAM	26.03	25.56	25.39
5+20	1	0	1	99		26.60	26.25	26.33
5+20	1	24	1	0		26.78	26.11	26.20



LTE Band 41_CA High Band Combin Maximum Average Power [dBm]								
BW [MHz]	PCC		SCC		Mod	Lowest	Middle	Highest
	RB Size	RB Offset	RB Size	RB Offset				
15+10	75	0	50	0	QPSK	28.04	27.51	27.23
15+10	1	0	1	49		28.89	28.76	28.91
15+10	1	74	1	0		29.05	28.67	28.40
15+10	75	0	50	0	16-QAM	27.15	26.55	26.35
15+10	1	0	1	49		28.17	27.89	27.99
15+10	1	74	1	0		28.37	27.95	27.68
15+10	75	0	50	0	64-QAM	26.02	25.96	25.39
15+10	1	0	1	49		27.08	26.86	26.77
15+10	1	74	1	0		27.18	26.72	26.53
10+15	50	0	75	0	QPSK	28.03	27.39	27.45
10+15	1	49	1	0		28.83	28.70	28.78
10+15	1	0	1	74		29.09	28.37	28.59
10+15	50	0	75	0	16-QAM	27.20	26.38	26.38
10+15	1	49	1	0		28.11	27.93	27.91
10+15	1	0	1	74		28.47	27.58	27.83
10+15	50	0	75	0	64-QAM	26.12	25.60	25.41
10+15	1	49	1	0		27.04	26.69	26.90
10+15	1	0	1	74		27.34	26.59	26.70
15+15	75	0	75	0	QPSK	27.93	27.56	27.50
15+15	1	0	1	74		28.56	28.88	28.89
15+15	1	74	1	0		29.07	28.61	28.62
15+15	75	0	75	0	16-QAM	27.06	26.63	26.44
15+15	1	0	1	74		27.81	28.13	28.02
15+15	1	74	1	0		28.38	27.77	27.88
15+15	75	0	75	0	64-QAM	26.07	25.74	25.51
15+15	1	0	1	74		26.96	26.97	27.03
15+15	1	74	1	0		27.34	26.78	26.78



<Non-Contiguous for TX Low Band Chain 1>

CA_41								
Combination 5MHz+20MHz								
PCC Channel	SCC Channel	Modulation	PCC		SCC		Total RB Size	Measured Power (dBm)
			RB Size	RB offset	RB Size	RB offset		
39675	40270	QPSK	25	0	100	0	125	24.45
			1	0	1	99	2	24.59
			1	24	1	0	2	25.48
		16QAM	25	0	100	0	125	23.56
			1	0	1	99	2	23.95
			1	24	1	0	2	24.67
		64QAM	25	0	100	0	125	22.60
			1	0	1	99	2	22.57
			1	24	1	0	2	23.32
CA_41								
Combination 20MHz+5MHz								
PCC Channel	SCC Channel	Modulation	PCC		SCC		Total RB Size	Measured Power (dBm)
			RB Size	RB offset	RB Size	RB offset		
39750	40345	QPSK	100	0	25	0	125	25.00
			1	0	1	24	2	25.39
			1	99	1	0	2	25.79
		16QAM	100	0	25	0	125	23.85
			1	0	1	24	2	24.73
			1	99	1	0	2	25.05
		64QAM	100	0	25	0	125	22.60
			1	0	1	24	2	22.53
			1	99	1	0	2	23.42
CA_41								
Combination 10MHz+15MHz								
PCC Channel	SCC Channel	Modulation	PCC		SCC		Total RB Size	Measured Power (dBm)
			RB Size	RB offset	RB Size	RB offset		
39700	40295	QPSK	50	0	75	0	125	24.44
			1	0	1	74	2	25.19
			1	49	1	0	2	25.91
		16QAM	50	0	75	0	125	23.53
			1	0	1	74	2	24.53
			1	49	1	0	2	25.12
		64QAM	50	0	75	0	125	22.67
			1	0	1	74	2	23.05
			1	49	1	0	2	23.97

CA_41								
Combination 15MHz+10MHz								
PCC Channel	SCC Channel	Modulation	PCC		SCC		Total RB Size	Measured Power (dBm)
			RB Size	RB offset	RB Size	RB offset		
39725	40320	QPSK	75	0	50	0	125	24.93
			1	0	1	49	2	25.53
			1	74	1	0	2	26.12
		16QAM	75	0	50	0	125	24.05
			1	0	1	49	2	24.85
			1	74	1	0	2	25.34
		64QAM	75	0	50	0	125	22.73
			1	0	1	49	2	23.09
			1	74	1	0	2	24.24
CA_41								
Combination 10MHz+20MHz								
PCC Channel	SCC Channel	Modulation	PCC		SCC		Total RB Size	Measured Power (dBm)
			RB Size	RB offset	RB Size	RB offset		
39700	40270	QPSK	50	0	100	0	150	24.68
			1	0	1	99	2	24.89
			1	49	1	0	2	26.11
		16QAM	50	0	100	0	150	23.76
			1	0	1	99	2	24.29
			1	49	1	0	2	25.31
		64QAM	50	0	100	0	150	22.60
			1	0	1	99	2	23.02
			1	49	1	0	2	23.76
CA_41								
Combination 20MHz+10MHz								
PCC Channel	SCC Channel	Modulation	PCC		SCC		Total RB Size	Measured Power (dBm)
			RB Size	RB offset	RB Size	RB offset		
39750	40320	QPSK	100	0	50	0	150	24.81
			1	0	1	49	2	25.41
			1	99	1	0	2	25.81
		16QAM	100	0	50	0	150	23.77
			1	0	1	49	2	24.66
			1	99	1	0	2	25.00
		64QAM	100	0	50	0	150	22.71
			1	0	1	49	2	23.06
			1	99	1	0	2	24.19

CA_41								
Combination 15MHz+15MHz								
PCC Channel	SCC Channel	Modulation	PCC		SCC		Total RB Size	Measured Power (dBm)
			RB Size	RB offset	RB Size	RB offset		
39725	40295	QPSK	75	0	75	0	150	24.63
			1	0	1	74	2	25.30
			1	74	1	0	2	26.01
		16QAM	75	0	75	0	150	23.73
			1	0	1	74	2	24.65
			1	74	1	0	2	25.24
		64QAM	75	0	75	0	150	22.88
			1	0	1	74	2	23.11
			1	74	1	0	2	24.22
CA_41								
Combination 15MHz+20MHz								
PCC Channel	SCC Channel	Modulation	PCC		SCC		Total RB Size	Measured Power (dBm)
			RB Size	RB offset	RB Size	RB offset		
39725	40270	QPSK	75	0	100	0	175	24.86
			1	0	1	99	2	25.01
			1	74	1	0	2	26.20
		16QAM	75	0	100	0	175	23.96
			1	0	1	99	2	24.41
			1	74	1	0	2	25.41
		64QAM	75	0	100	0	175	22.81
			1	0	1	99	2	23.08
			1	74	1	0	2	24.02
CA_41								
Combination 20MHz+15MHz								
PCC Channel	SCC Channel	Modulation	PCC		SCC		Total RB Size	Measured Power (dBm)
			RB Size	RB offset	RB Size	RB offset		
39750	40295	QPSK	100	0	75	0	175	24.50
			1	0	1	74	2	25.18
			1	99	1	0	2	25.69
		16QAM	100	0	75	0	175	23.44
			1	0	1	74	2	24.44
			1	99	1	0	2	24.89
		64QAM	100	0	75	0	175	22.87
			1	0	1	74	2	23.08
			1	99	1	0	2	24.17

CA_41								
Combination 20MHz+20MHz (100RB+100RB)								
PCC Channel	SCC Channel	Modulation	PCC		SCC		Total RB Size	Measured Power (dBm)
			RB Size	RB offset	RB Size	RB offset		
39750	40270	QPSK	100	0	100	0	200	24.73
			1	0	1	99	2	24.88
			1	99	1	0	2	25.89
		16QAM	100	0	100	0	200	23.68
			1	0	1	99	2	24.19
			1	99	1	0	2	25.08
		64QAM	100	0	100	0	200	22.79
			1	0	1	99	2	23.04
			1	99	1	0	2	23.97



<Non-Contiguous for TX Low Band Chain 2>

CA_41								
Combination 5MHz+20MHz								
PCC Channel	SCC Channel	Modulation	PCC		SCC		Total RB Size	Measured Power (dBm)
			RB Size	RB offset	RB Size	RB offset		
39675	40270	QPSK	25	0	100	0	125	24.46
			1	0	1	99	2	25.27
			1	24	1	0	2	25.25
		16QAM	25	0	100	0	125	23.48
			1	0	1	99	2	24.59
			1	24	1	0	2	24.51
		64QAM	25	0	100	0	125	22.56
			1	0	1	99	2	23.37
			1	24	1	0	2	23.21
CA_41								
Combination 20MHz+5MHz								
PCC Channel	SCC Channel	Modulation	PCC		SCC		Total RB Size	Measured Power (dBm)
			RB Size	RB offset	RB Size	RB offset		
39750	40345	QPSK	100	0	25	0	125	24.50
			1	0	1	24	2	24.97
			1	99	1	0	2	25.20
		16QAM	100	0	25	0	125	23.49
			1	0	1	24	2	24.11
			1	99	1	0	2	24.58
		64QAM	100	0	25	0	125	22.81
			1	0	1	24	2	23.22
			1	99	1	0	2	23.47
CA_41								
Combination 10MHz+15MHz								
PCC Channel	SCC Channel	Modulation	PCC		SCC		Total RB Size	Measured Power (dBm)
			RB Size	RB offset	RB Size	RB offset		
39700	40295	QPSK	50	0	75	0	125	24.87
			1	0	1	74	2	25.68
			1	49	1	0	2	25.79
		16QAM	50	0	75	0	125	23.97
			1	0	1	74	2	24.99
			1	49	1	0	2	25.04
		64QAM	50	0	75	0	125	22.87
			1	0	1	74	2	23.75
			1	49	1	0	2	23.81

CA_41								
Combination 15MHz+10MHz								
PCC Channel	SCC Channel	Modulation	PCC		SCC		Total RB Size	Measured Power (dBm)
			RB Size	RB offset	RB Size	RB offset		
39725	40320	QPSK	75	0	50	0	125	24.92
			1	0	1	49	2	25.65
			1	74	1	0	2	25.70
		16QAM	75	0	50	0	125	23.92
			1	0	1	49	2	24.98
			1	74	1	0	2	24.93
		64QAM	75	0	50	0	125	22.93
			1	0	1	49	2	23.80
			1	74	1	0	2	23.88
CA_41								
Combination 10MHz+20MHz								
PCC Channel	SCC Channel	Modulation	PCC		SCC		Total RB Size	Measured Power (dBm)
			RB Size	RB offset	RB Size	RB offset		
39700	40270	QPSK	50	0	100	0	150	24.60
			1	0	1	99	2	25.63
			1	49	1	0	2	25.65
		16QAM	50	0	100	0	150	23.60
			1	0	1	99	2	24.85
			1	49	1	0	2	24.82
		64QAM	50	0	100	0	150	22.73
			1	0	1	99	2	23.78
			1	49	1	0	2	23.64
CA_41								
Combination 20MHz+10MHz								
PCC Channel	SCC Channel	Modulation	PCC		SCC		Total RB Size	Measured Power (dBm)
			RB Size	RB offset	RB Size	RB offset		
39750	40320	QPSK	100	0	50	0	150	24.66
			1	0	1	49	2	25.53
			1	99	1	0	2	25.55
		16QAM	100	0	50	0	150	23.67
			1	0	1	49	2	24.82
			1	99	1	0	2	24.89
		64QAM	100	0	50	0	150	22.82
			1	0	1	49	2	23.81
			1	99	1	0	2	23.92

CA_41								
Combination 15MHz+15MHz								
PCC Channel	SCC Channel	Modulation	PCC		SCC		Total RB Size	Measured Power (dBm)
			RB Size	RB offset	RB Size	RB offset		
39725	40295	QPSK	75	0	75	0	150	24.90
			1	0	1	74	2	25.74
			1	74	1	0	2	25.73
		16QAM	75	0	75	0	150	23.96
			1	0	1	74	2	25.08
			1	74	1	0	2	25.00
		64QAM	75	0	75	0	150	22.89
			1	0	1	74	2	23.79
			1	74	1	0	2	23.78
CA_41								
Combination 15MHz+20MHz								
PCC Channel	SCC Channel	Modulation	PCC		SCC		Total RB Size	Measured Power (dBm)
			RB Size	RB offset	RB Size	RB offset		
39725	40270	QPSK	75	0	100	0	175	24.63
			1	0	1	99	2	25.69
			1	74	1	0	2	25.59
		16QAM	75	0	100	0	175	23.59
			1	0	1	99	2	24.94
			1	74	1	0	2	24.78
		64QAM	75	0	100	0	175	22.75
			1	0	1	99	2	23.82
			1	74	1	0	2	23.61
CA_41								
Combination 20MHz+15MHz								
PCC Channel	SCC Channel	Modulation	PCC		SCC		Total RB Size	Measured Power (dBm)
			RB Size	RB offset	RB Size	RB offset		
39750	40295	QPSK	100	0	75	0	175	24.64
			1	0	1	74	2	25.62
			1	99	1	0	2	25.59
		16QAM	100	0	75	0	175	23.71
			1	0	1	74	2	24.92
			1	99	1	0	2	24.97
		64QAM	100	0	75	0	175	22.78
			1	0	1	74	2	23.80
			1	99	1	0	2	23.83

CA_41								
Combination 20MHz+20MHz (100RB+100RB)								
PCC Channel	SCC Channel	Modulation	PCC		SCC		Total RB Size	Measured Power (dBm)
			RB Size	RB offset	RB Size	RB offset		
39750	40270	QPSK	100	0	100	0	200	24.35
			1	0	1	99	2	25.57
			1	99	1	0	2	25.44
		16QAM	100	0	100	0	200	23.32
			1	0	1	99	2	24.78
			1	99	1	0	2	24.74
		64QAM	100	0	100	0	200	22.64
			1	0	1	99	2	23.84
			1	99	1	0	2	23.66



<Non-Contiguous for TX Low Band Chain 1+2>

CA_41								
Combination 5MHz+20MHz								
PCC Channel	SCC Channel	Modulation	PCC		SCC		Total RB Size	Measured Power (dBm)
			RB Size	RB offset	RB Size	RB offset		
39675	40270	QPSK	25	0	100	0	125	27.46
			1	0	1	99	2	27.95
			1	24	1	0	2	28.38
		16QAM	25	0	100	0	125	26.53
			1	0	1	99	2	27.29
			1	24	1	0	2	27.60
		64QAM	25	0	100	0	125	25.59
			1	0	1	99	2	26.00
			1	24	1	0	2	26.28
CA_41								
Combination 20MHz+5MHz								
PCC Channel	SCC Channel	Modulation	PCC		SCC		Total RB Size	Measured Power (dBm)
			RB Size	RB offset	RB Size	RB offset		
39750	40345	QPSK	100	0	25	0	125	27.77
			1	0	1	24	2	28.20
			1	99	1	0	2	28.51
		16QAM	100	0	25	0	125	26.69
			1	0	1	24	2	27.44
			1	99	1	0	2	27.83
		64QAM	100	0	25	0	125	25.72
			1	0	1	24	2	25.90
			1	99	1	0	2	26.46
CA_41								
Combination 10MHz+15MHz								
PCC Channel	SCC Channel	Modulation	PCC		SCC		Total RB Size	Measured Power (dBm)
			RB Size	RB offset	RB Size	RB offset		
39700	40295	QPSK	50	0	75	0	125	27.67
			1	0	1	74	2	28.45
			1	49	1	0	2	28.86
		16QAM	50	0	75	0	125	26.76
			1	0	1	74	2	27.78
			1	49	1	0	2	28.09
		64QAM	50	0	75	0	125	25.78
			1	0	1	74	2	26.42
			1	49	1	0	2	26.90

CA_41								
Combination 15MHz+10MHz								
PCC Channel	SCC Channel	Modulation	PCC		SCC		Total RB Size	Measured Power (dBm)
			RB Size	RB offset	RB Size	RB offset		
39725	40320	QPSK	75	0	50	0	125	27.94
			1	0	1	49	2	28.60
			1	74	1	0	2	28.93
		16QAM	75	0	50	0	125	26.99
			1	0	1	49	2	27.93
			1	74	1	0	2	28.15
		64QAM	75	0	50	0	125	25.84
			1	0	1	49	2	26.47
			1	74	1	0	2	27.07
CA_41								
Combination 10MHz+20MHz								
PCC Channel	SCC Channel	Modulation	PCC		SCC		Total RB Size	Measured Power (dBm)
			RB Size	RB offset	RB Size	RB offset		
39700	40270	QPSK	50	0	100	0	150	27.65
			1	0	1	99	2	28.29
			1	49	1	0	2	28.89
		16QAM	50	0	100	0	150	26.69
			1	0	1	99	2	27.59
			1	49	1	0	2	28.08
		64QAM	50	0	100	0	150	25.67
			1	0	1	99	2	26.43
			1	49	1	0	2	26.71
CA_41								
Combination 20MHz+10MHz								
PCC Channel	SCC Channel	Modulation	PCC		SCC		Total RB Size	Measured Power (dBm)
			RB Size	RB offset	RB Size	RB offset		
39750	40320	QPSK	100	0	50	0	150	27.75
			1	0	1	49	2	28.48
			1	99	1	0	2	28.69
		16QAM	100	0	50	0	150	26.73
			1	0	1	49	2	27.75
			1	99	1	0	2	27.95
		64QAM	100	0	50	0	150	25.78
			1	0	1	49	2	26.46
			1	99	1	0	2	27.07

CA_41								
Combination 15MHz+15MHz								
PCC Channel	SCC Channel	Modulation	PCC		SCC		Total RB Size	Measured Power (dBm)
			RB Size	RB offset	RB Size	RB offset		
39725	40295	QPSK	75	0	75	0	150	27.78
			1	0	1	74	2	28.54
			1	74	1	0	2	28.88
		16QAM	75	0	75	0	150	26.86
			1	0	1	74	2	27.88
			1	74	1	0	2	28.13
		64QAM	75	0	75	0	150	25.90
			1	0	1	74	2	26.47
			1	74	1	0	2	27.02
CA_41								
Combination 15MHz+20MHz								
PCC Channel	SCC Channel	Modulation	PCC		SCC		Total RB Size	Measured Power (dBm)
			RB Size	RB offset	RB Size	RB offset		
39725	40270	QPSK	75	0	100	0	175	27.76
			1	0	1	99	2	28.37
			1	74	1	0	2	28.92
		16QAM	75	0	100	0	175	26.78
			1	0	1	99	2	27.69
			1	74	1	0	2	28.12
		64QAM	75	0	100	0	175	25.79
			1	0	1	99	2	26.48
			1	74	1	0	2	26.83
CA_41								
Combination 20MHz+15MHz								
PCC Channel	SCC Channel	Modulation	PCC		SCC		Total RB Size	Measured Power (dBm)
			RB Size	RB offset	RB Size	RB offset		
39750	40295	QPSK	100	0	75	0	175	27.58
			1	0	1	74	2	28.42
			1	99	1	0	2	28.65
		16QAM	100	0	75	0	175	26.59
			1	0	1	74	2	27.70
			1	99	1	0	2	27.94
		64QAM	100	0	75	0	175	25.83
			1	0	1	74	2	26.46
			1	99	1	0	2	27.01

CA_41								
Combination 20MHz+20MHz (100RB+100RB)								
PCC Channel	SCC Channel	Modulation	PCC		SCC		Total RB Size	Measured Power (dBm)
			RB Size	RB offset	RB Size	RB offset		
39750	40270	QPSK	100	0	100	0	200	27.56
			1	0	1	99	2	28.25
			1	99	1	0	2	28.68
		16QAM	100	0	100	0	200	26.51
			1	0	1	99	2	27.51
			1	99	1	0	2	27.92
		64QAM	100	0	100	0	200	25.73
			1	0	1	99	2	26.47
			1	99	1	0	2	26.83



<Non-Contiguous for TX High Band Chain 1>

CA_41								
Combination 5MHz+20MHz								
PCC Channel	SCC Channel	Modulation	PCC		SCC		Total RB Size	Measured Power (dBm)
			RB Size	RB offset	RB Size	RB offset		
40895	41490	QPSK	25	0	100	0	125	24.75
			1	0	1	99	2	25.64
			1	24	1	0	2	25.55
		16QAM	25	0	100	0	125	23.74
			1	0	1	99	2	24.95
			1	24	1	0	2	24.85
		64QAM	25	0	100	0	125	22.73
			1	0	1	99	2	23.78
			1	24	1	0	2	23.58
CA_41								
Combination 20MHz+5MHz								
PCC Channel	SCC Channel	Modulation	PCC		SCC		Total RB Size	Measured Power (dBm)
			RB Size	RB offset	RB Size	RB offset		
40970	41565	QPSK	100	0	25	0	125	24.11
			1	0	1	24	2	24.96
			1	99	1	0	2	25.14
		16QAM	100	0	25	0	125	23.31
			1	0	1	24	2	24.44
			1	99	1	0	2	24.09
		64QAM	100	0	25	0	125	22.86
			1	0	1	24	2	23.54
			1	99	1	0	2	23.29
CA_41								
Combination 10MHz+15MHz								
PCC Channel	SCC Channel	Modulation	PCC		SCC		Total RB Size	Measured Power (dBm)
			RB Size	RB offset	RB Size	RB offset		
40920	41515	QPSK	50	0	75	0	125	24.76
			1	0	1	74	2	25.97
			1	49	1	0	2	25.74
		16QAM	50	0	75	0	125	23.67
			1	0	1	74	2	25.18
			1	49	1	0	2	25.04
		64QAM	50	0	75	0	125	22.86
			1	0	1	74	2	24.24
			1	49	1	0	2	23.99

CA_41								
Combination 15MHz+10MHz								
PCC Channel	SCC Channel	Modulation	PCC		SCC		Total RB Size	Measured Power (dBm)
			RB Size	RB offset	RB Size	RB offset		
40945	41540	QPSK	75	0	50	0	125	24.45
			1	0	1	49	2	26.07
			1	74	1	0	2	25.65
		16QAM	75	0	50	0	125	23.72
			1	0	1	49	2	25.31
			1	74	1	0	2	25.01
		64QAM	75	0	50	0	125	22.80
			1	0	1	49	2	24.25
			1	74	1	0	2	23.71
CA_41								
Combination 10MHz+20MHz								
PCC Channel	SCC Channel	Modulation	PCC		SCC		Total RB Size	Measured Power (dBm)
			RB Size	RB offset	RB Size	RB offset		
40920	41490	QPSK	50	0	100	0	150	24.81
			1	0	1	99	2	25.94
			1	49	1	0	2	25.79
		16QAM	50	0	100	0	150	23.81
			1	0	1	99	2	25.30
			1	49	1	0	2	25.12
		64QAM	50	0	100	0	150	22.77
			1	0	1	99	2	24.18
			1	49	1	0	2	23.99
CA_41								
Combination 20MHz+10MHz								
PCC Channel	SCC Channel	Modulation	PCC		SCC		Total RB Size	Measured Power (dBm)
			RB Size	RB offset	RB Size	RB offset		
40970	41540	QPSK	100	0	50	0	150	23.91
			1	0	1	49	2	25.83
			1	99	1	0	2	25.42
		16QAM	100	0	50	0	150	23.37
			1	0	1	49	2	25.00
			1	99	1	0	2	24.75
		64QAM	100	0	50	0	150	22.78
			1	0	1	49	2	24.13
			1	99	1	0	2	23.62

CA_41								
Combination 15MHz+15MHz								
PCC Channel	SCC Channel	Modulation	PCC		SCC		Total RB Size	Measured Power (dBm)
			RB Size	RB offset	RB Size	RB offset		
40945	41515	QPSK	75	0	75	0	150	24.83
			1	0	1	74	2	26.06
			1	74	1	0	2	25.76
		16QAM	75	0	75	0	150	23.79
			1	0	1	74	2	25.30
			1	74	1	0	2	25.10
		64QAM	75	0	75	0	150	22.86
			1	0	1	74	2	24.36
			1	74	1	0	2	23.95
CA_41								
Combination 15MHz+20MHz								
PCC Channel	SCC Channel	Modulation	PCC		SCC		Total RB Size	Measured Power (dBm)
			RB Size	RB offset	RB Size	RB offset		
40945	41490	QPSK	75	0	100	0	175	24.87
			1	0	1	99	2	26.04
			1	74	1	0	2	25.80
		16QAM	75	0	100	0	175	23.93
			1	0	1	99	2	25.41
			1	74	1	0	2	25.18
		64QAM	75	0	100	0	175	22.77
			1	0	1	99	2	24.31
			1	74	1	0	2	23.95
CA_41								
Combination 20MHz+15MHz								
PCC Channel	SCC Channel	Modulation	PCC		SCC		Total RB Size	Measured Power (dBm)
			RB Size	RB offset	RB Size	RB offset		
40970	41515	QPSK	100	0	75	0	175	24.34
			1	0	1	74	2	25.81
			1	99	1	0	2	25.54
		16QAM	100	0	75	0	175	23.45
			1	0	1	74	2	24.99
			1	99	1	0	2	24.85
		64QAM	100	0	75	0	175	22.85
			1	0	1	74	2	24.25
			1	99	1	0	2	23.86

CA_41								
Combination 20MHz+20MHz (100RB+100RB)								
PCC Channel	SCC Channel	Modulation	PCC		SCC		Total RB Size	Measured Power (dBm)
			RB Size	RB offset	RB Size	RB offset		
40970	41490	QPSK	100	0	100	0	200	24.39
			1	0	1	99	2	25.79
			1	99	1	0	2	25.59
		16QAM	100	0	100	0	200	23.60
			1	0	1	99	2	25.12
			1	99	1	0	2	24.93
		64QAM	100	0	100	0	200	22.75
			1	0	1	99	2	24.19
			1	99	1	0	2	23.86



<Non-Contiguous for TX High Band Chain 2>

CA_41								
Combination 5MHz+20MHz								
PCC Channel	SCC Channel	Modulation	PCC		SCC		Total RB Size	Measured Power (dBm)
			RB Size	RB offset	RB Size	RB offset		
40895	41490	QPSK	25	0	100	0	125	24.54
			1	0	1	99	2	25.08
			1	24	1	0	2	25.09
		16QAM	25	0	100	0	125	23.39
			1	0	1	99	2	24.48
			1	24	1	0	2	24.54
		64QAM	25	0	100	0	125	22.61
			1	0	1	99	2	23.54
			1	24	1	0	2	23.56
CA_41								
Combination 20MHz+5MHz								
PCC Channel	SCC Channel	Modulation	PCC		SCC		Total RB Size	Measured Power (dBm)
			RB Size	RB offset	RB Size	RB offset		
40970	41565	QPSK	100	0	25	0	125	24.41
			1	0	1	24	2	25.09
			1	99	1	0	2	24.89
		16QAM	100	0	25	0	125	23.48
			1	0	1	24	2	24.41
			1	99	1	0	2	24.22
		64QAM	100	0	25	0	125	22.89
			1	0	1	24	2	23.33
			1	99	1	0	2	23.23
CA_41								
Combination 10MHz+15MHz								
PCC Channel	SCC Channel	Modulation	PCC		SCC		Total RB Size	Measured Power (dBm)
			RB Size	RB offset	RB Size	RB offset		
40920	41515	QPSK	50	0	75	0	125	24.51
			1	0	1	74	2	25.59
			1	49	1	0	2	25.83
		16QAM	50	0	75	0	125	23.59
			1	0	1	74	2	24.76
			1	49	1	0	2	25.08
		64QAM	50	0	75	0	125	22.68
			1	0	1	74	2	23.92
			1	49	1	0	2	24.00

CA_41								
Combination 15MHz+10MHz								
PCC Channel	SCC Channel	Modulation	PCC		SCC		Total RB Size	Measured Power (dBm)
			RB Size	RB offset	RB Size	RB offset		
40945	41540	QPSK	75	0	50	0	125	24.64
			1	0	1	49	2	25.69
			1	74	1	0	2	25.74
		16QAM	75	0	50	0	125	23.67
			1	0	1	49	2	24.83
			1	74	1	0	2	25.00
		64QAM	75	0	50	0	125	22.88
			1	0	1	49	2	23.66
			1	74	1	0	2	24.18
CA_41								
Combination 10MHz+20MHz								
PCC Channel	SCC Channel	Modulation	PCC		SCC		Total RB Size	Measured Power (dBm)
			RB Size	RB offset	RB Size	RB offset		
40920	41490	QPSK	50	0	100	0	150	24.57
			1	0	1	99	2	25.46
			1	49	1	0	2	25.78
		16QAM	50	0	100	0	150	23.55
			1	0	1	99	2	24.72
			1	49	1	0	2	25.10
		64QAM	50	0	100	0	150	22.94
			1	0	1	99	2	24.06
			1	49	1	0	2	24.19
CA_41								
Combination 20MHz+10MHz								
PCC Channel	SCC Channel	Modulation	PCC		SCC		Total RB Size	Measured Power (dBm)
			RB Size	RB offset	RB Size	RB offset		
40970	41540	QPSK	100	0	50	0	150	24.45
			1	0	1	49	2	25.69
			1	99	1	0	2	25.48
		16QAM	100	0	50	0	150	23.46
			1	0	1	49	2	24.89
			1	99	1	0	2	24.83
		64QAM	100	0	50	0	150	22.80
			1	0	1	49	2	23.48
			1	99	1	0	2	24.04

CA_41								
Combination 15MHz+15MHz								
PCC Channel	SCC Channel	Modulation	PCC		SCC		Total RB Size	Measured Power (dBm)
			RB Size	RB offset	RB Size	RB offset		
40945	41515	QPSK	75	0	75	0	150	24.74
			1	0	1	74	2	25.70
			1	74	1	0	2	25.87
		16QAM	75	0	75	0	150	23.75
			1	0	1	74	2	24.88
			1	74	1	0	2	25.12
		64QAM	75	0	75	0	150	22.94
			1	0	1	74	2	24.01
			1	74	1	0	2	24.06
CA_41								
Combination 15MHz+20MHz								
PCC Channel	SCC Channel	Modulation	PCC		SCC		Total RB Size	Measured Power (dBm)
			RB Size	RB offset	RB Size	RB offset		
40945	41490	QPSK	75	0	100	0	175	24.79
			1	0	1	99	2	25.58
			1	74	1	0	2	25.82
		16QAM	75	0	100	0	175	23.70
			1	0	1	99	2	24.85
			1	74	1	0	2	25.14
		64QAM	75	0	100	0	175	22.94
			1	0	1	99	2	24.06
			1	74	1	0	2	24.19
CA_41								
Combination 20MHz+15MHz								
PCC Channel	SCC Channel	Modulation	PCC		SCC		Total RB Size	Measured Power (dBm)
			RB Size	RB offset	RB Size	RB offset		
40970	41515	QPSK	100	0	75	0	175	24.55
			1	0	1	74	2	25.70
			1	99	1	0	2	25.62
		16QAM	100	0	75	0	175	23.54
			1	0	1	74	2	24.93
			1	99	1	0	2	24.96
		64QAM	100	0	75	0	175	22.86
			1	0	1	74	2	23.84
			1	99	1	0	2	23.92

CA_41								
Combination 20MHz+20MHz (100RB+100RB)								
PCC Channel	SCC Channel	Modulation	PCC		SCC		Total RB Size	Measured Power (dBm)
			RB Size	RB offset	RB Size	RB offset		
40970	41490	QPSK	100	0	100	0	200	24.61
			1	0	1	99	2	25.57
			1	99	1	0	2	25.57
		16QAM	100	0	100	0	200	23.49
			1	0	1	99	2	24.90
			1	99	1	0	2	24.98
		64QAM	100	0	100	0	200	22.86
			1	0	1	99	2	23.89
			1	99	1	0	2	24.06



<Non-Contiguous for TX High Band Chain 1+2>

CA_41								
Combination 5MHz+20MHz								
PCC Channel	SCC Channel	Modulation	PCC		SCC		Total RB Size	Measured Power (dBm)
			RB Size	RB offset	RB Size	RB offset		
40895	41490	QPSK	25	0	100	0	125	27.66
			1	0	1	99	2	28.38
			1	24	1	0	2	28.34
		16QAM	25	0	100	0	125	26.58
			1	0	1	99	2	27.73
			1	24	1	0	2	27.71
		64QAM	25	0	100	0	125	25.68
			1	0	1	99	2	26.67
			1	24	1	0	2	26.58
CA_41								
Combination 20MHz+5MHz								
PCC Channel	SCC Channel	Modulation	PCC		SCC		Total RB Size	Measured Power (dBm)
			RB Size	RB offset	RB Size	RB offset		
40970	41565	QPSK	100	0	25	0	125	27.27
			1	0	1	24	2	28.04
			1	99	1	0	2	28.02
		16QAM	100	0	25	0	125	26.41
			1	0	1	24	2	27.44
			1	99	1	0	2	27.17
		64QAM	100	0	25	0	125	25.89
			1	0	1	24	2	26.45
			1	99	1	0	2	26.27
CA_41								
Combination 10MHz+15MHz								
PCC Channel	SCC Channel	Modulation	PCC		SCC		Total RB Size	Measured Power (dBm)
			RB Size	RB offset	RB Size	RB offset		
40920	41515	QPSK	50	0	75	0	125	27.65
			1	0	1	74	2	28.79
			1	49	1	0	2	28.79
		16QAM	50	0	75	0	125	26.64
			1	0	1	74	2	27.98
			1	49	1	0	2	28.07
		64QAM	50	0	75	0	125	25.78
			1	0	1	74	2	27.09
			1	49	1	0	2	27.01

CA_41								
Combination 15MHz+10MHz								
PCC Channel	SCC Channel	Modulation	PCC		SCC		Total RB Size	Measured Power (dBm)
			RB Size	RB offset	RB Size	RB offset		
40945	41540	QPSK	75	0	50	0	125	27.55
			1	0	1	49	2	28.90
			1	74	1	0	2	28.71
		16QAM	75	0	50	0	125	26.70
			1	0	1	49	2	28.09
			1	74	1	0	2	28.02
		64QAM	75	0	50	0	125	25.85
			1	0	1	49	2	26.98
			1	74	1	0	2	26.96
CA_41								
Combination 10MHz+20MHz								
PCC Channel	SCC Channel	Modulation	PCC		SCC		Total RB Size	Measured Power (dBm)
			RB Size	RB offset	RB Size	RB offset		
40920	41490	QPSK	50	0	100	0	150	27.70
			1	0	1	99	2	28.72
			1	49	1	0	2	28.79
		16QAM	50	0	100	0	150	26.69
			1	0	1	99	2	28.03
			1	49	1	0	2	28.12
		64QAM	50	0	100	0	150	25.87
			1	0	1	99	2	27.13
			1	49	1	0	2	27.10
CA_41								
Combination 20MHz+10MHz								
PCC Channel	SCC Channel	Modulation	PCC		SCC		Total RB Size	Measured Power (dBm)
			RB Size	RB offset	RB Size	RB offset		
40970	41540	QPSK	100	0	50	0	150	27.20
			1	0	1	49	2	28.77
			1	99	1	0	2	28.46
		16QAM	100	0	50	0	150	26.42
			1	0	1	49	2	27.95
			1	99	1	0	2	27.80
		64QAM	100	0	50	0	150	25.80
			1	0	1	49	2	26.83
			1	99	1	0	2	26.84

CA_41								
Combination 15MHz+15MHz								
PCC Channel	SCC Channel	Modulation	PCC		SCC		Total RB Size	Measured Power (dBm)
			RB Size	RB offset	RB Size	RB offset		
40945	41515	QPSK	75	0	75	0	150	27.79
			1	0	1	74	2	28.89
			1	74	1	0	2	28.82
		16QAM	75	0	75	0	150	26.78
			1	0	1	74	2	28.10
			1	74	1	0	2	28.12
		64QAM	75	0	75	0	150	25.91
			1	0	1	74	2	27.20
			1	74	1	0	2	27.01
CA_41								
Combination 15MHz+20MHz								
PCC Channel	SCC Channel	Modulation	PCC		SCC		Total RB Size	Measured Power (dBm)
			RB Size	RB offset	RB Size	RB offset		
40945	41490	QPSK	75	0	100	0	175	27.84
			1	0	1	99	2	28.82
			1	74	1	0	2	28.82
		16QAM	75	0	100	0	175	26.83
			1	0	1	99	2	28.15
			1	74	1	0	2	28.17
		64QAM	75	0	100	0	175	25.87
			1	0	1	99	2	27.20
			1	74	1	0	2	27.08
CA_41								
Combination 20MHz+15MHz								
PCC Channel	SCC Channel	Modulation	PCC		SCC		Total RB Size	Measured Power (dBm)
			RB Size	RB offset	RB Size	RB offset		
40970	41515	QPSK	100	0	75	0	175	27.46
			1	0	1	74	2	28.76
			1	99	1	0	2	28.59
		16QAM	100	0	75	0	175	26.50
			1	0	1	74	2	27.97
			1	99	1	0	2	27.91
		64QAM	100	0	75	0	175	25.86
			1	0	1	74	2	27.06
			1	99	1	0	2	26.90

CA_41								
Combination 20MHz+20MHz (100RB+100RB)								
PCC Channel	SCC Channel	Modulation	PCC		SCC		Total RB Size	Measured Power (dBm)
			RB Size	RB offset	RB Size	RB offset		
40970	41490	QPSK	100	0	100	0	200	27.51
			1	0	1	99	2	28.69
			1	99	1	0	2	28.59
		16QAM	100	0	100	0	200	26.56
			1	0	1	99	2	28.02
			1	99	1	0	2	27.96
		64QAM	100	0	100	0	200	25.82
			1	0	1	99	2	27.05
			1	99	1	0	2	26.97



LTE Band 25

<For 2x2 Tx Chain 1>

Peak-to-Average Ratio

Mode	LTE Band 25 / 20MHz				
Mod.	QPSK		16QAM		Limit: 13dB
RB Size	1RB	Full RB	1RB	Full RB	Result
Lowest CH	3.57	4.41	3.71	4.99	PASS
Middle CH	5.36	4.29	5.94	4.81	
Highest CH	4.72	4.55	5.74	5.22	



LTE Band 25 / 20MHz / QPSK

Lowest Channel / 1RB

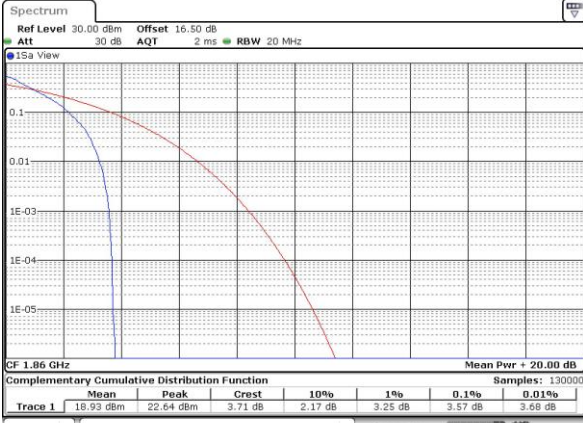

Date: 12 DEC 2018 16:41:20

Lowest Channel / Full RB



Date: 12 DEC 2018 16:41:32

Middle Channel / 1RB



Date: 12 DEC 2018 16:42:02

Middle Channel / Full RB

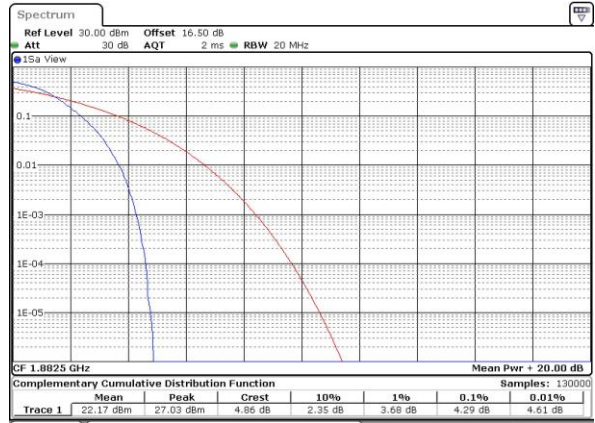

Date: 12 DEC 2018 16:42:12

Highest Channel / 1RB



Date: 12 DEC 2018 16:42:53

Highest Channel / Full RB



Date: 12 DEC 2018 16:43:03



LTE Band 25 / 20MHz / 16QAM

Lowest Channel / 1RB



Date: 12 DEC 2018 16:40:59

Lowest Channel / Full RB

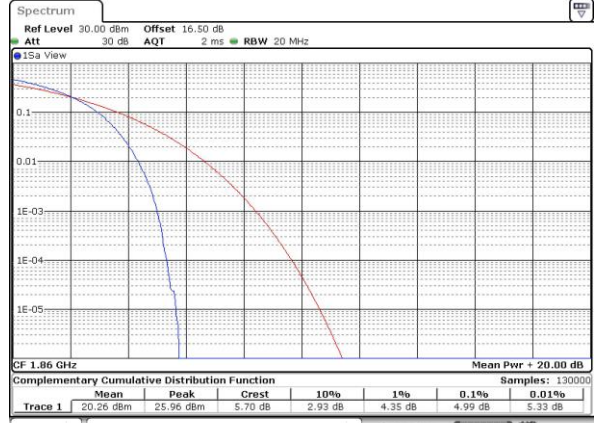

Date: 12 DEC 2018 16:41:10

Middle Channel / 1RB

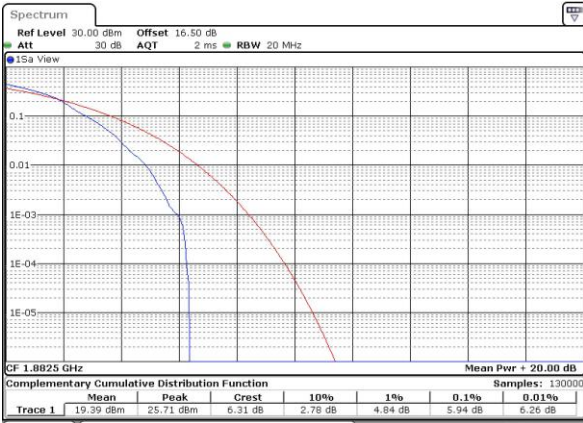

Date: 12 DEC 2018 16:41:42

Middle Channel / Full RB



Date: 12 DEC 2018 16:41:52

Highest Channel / 1RB

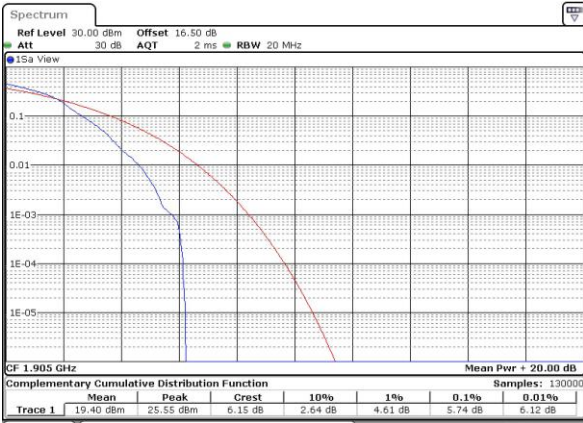

Date: 12 DEC 2018 16:42:22

Highest Channel / Full RB



Date: 12 DEC 2018 16:42:43



26dB Bandwidth

Mode	LTE Band 25 : 26dB BW(MHz)											
	1.4MHz		3MHz		5MHz		10MHz		15MHz		20MHz	
BW	QPSK	16QAM	QPSK	16QAM	QPSK	16QAM	QPSK	16QAM	QPSK	16QAM	QPSK	16QAM
Mod.	QPSK	16QAM	QPSK	16QAM	QPSK	16QAM	QPSK	16QAM	QPSK	16QAM	QPSK	16QAM
Lowest CH	-	-	-	-	5.41	5.44	9.89	9.87	14.30	14.54	20.10	20.18
Middle CH	-	-	-	-	5.38	5.19	9.91	9.71	14.15	14.60	20.22	20.06
Highest CH	-	-	-	-	5.16	5.09	9.87	10.01	14.27	14.30	20.18	20.14



LTE Band 25

Lowest Channel / 5MHz / QPSK

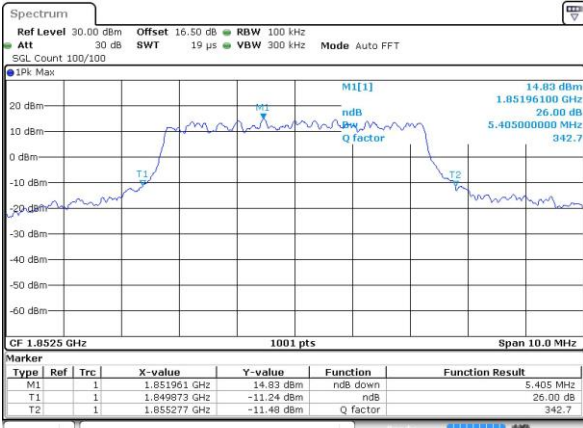

Date: 12 DEC 2018 13:50:14

Lowest Channel / 5MHz / 16QAM

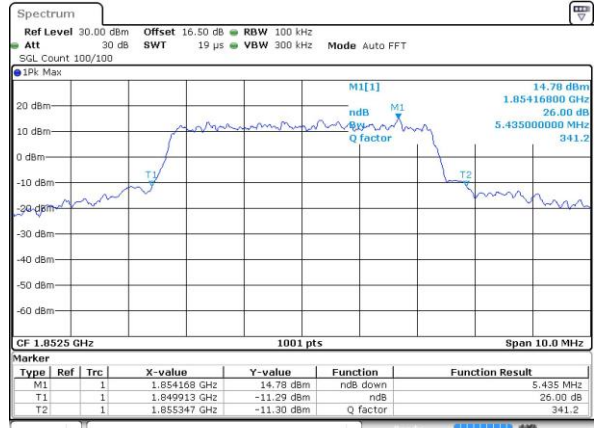

Date: 12 DEC 2018 13:50:26

Middle Channel / 5MHz / QPSK

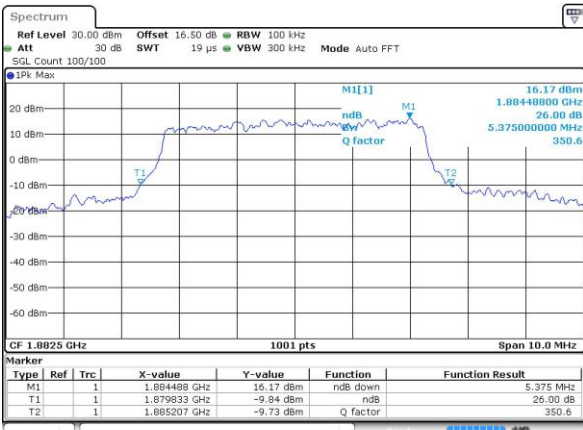

Date: 12 DEC 2018 15:31:17

Middle Channel / 5MHz / 16QAM

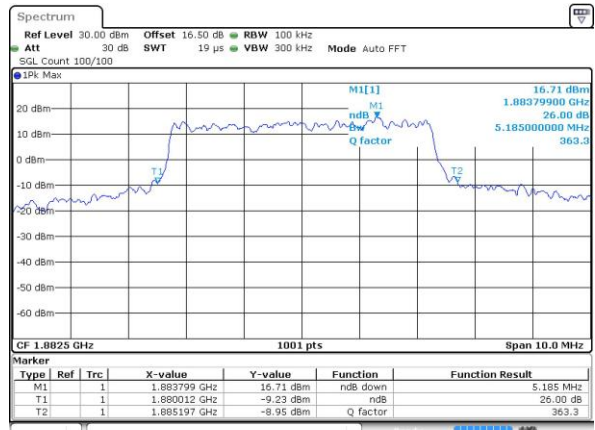

Date: 12 DEC 2018 15:31:28

Highest Channel / 5MHz / QPSK

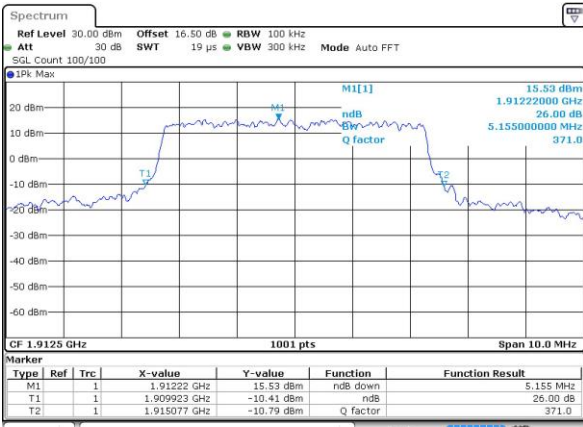

Date: 12 DEC 2018 13:57:00

Highest Channel / 5MHz / 16QAM

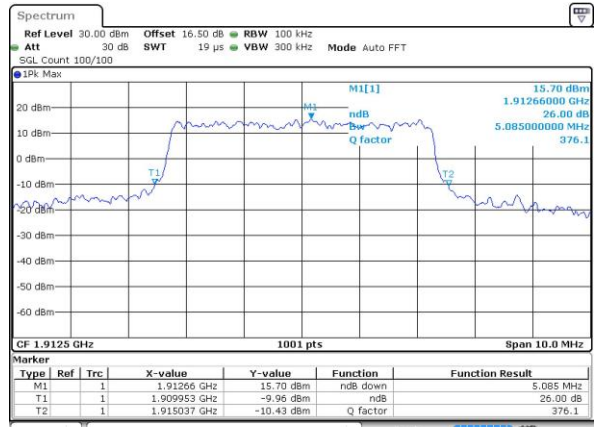

Date: 12 DEC 2018 13:56:48



LTE Band 25

Lowest Channel / 10MHz / QPSK

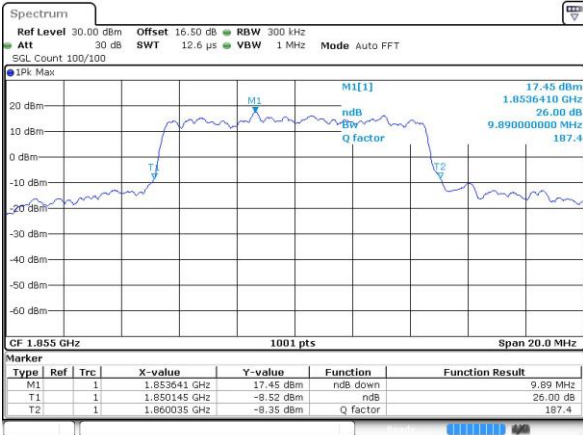

Date: 12 DEC 2018 14:01:06

Lowest Channel / 10MHz / 16QAM

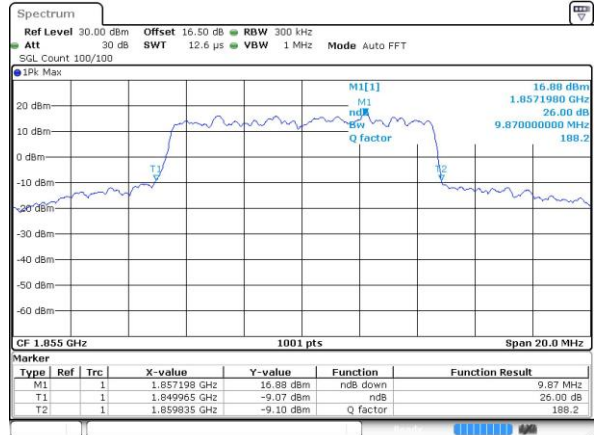

Date: 12 DEC 2018 14:01:17

Middle Channel / 10MHz / QPSK



Date: 12 DEC 2018 15:33:33

Middle Channel / 10MHz / 16QAM

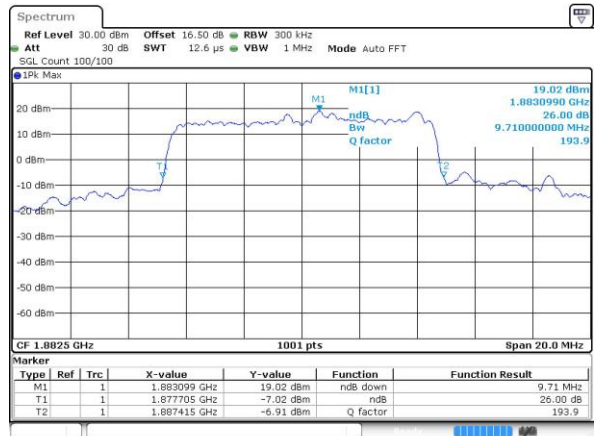

Date: 12 DEC 2018 15:33:44

Highest Channel / 10MHz / QPSK



Date: 12 DEC 2018 14:07:51

Highest Channel / 10MHz / 16QAM

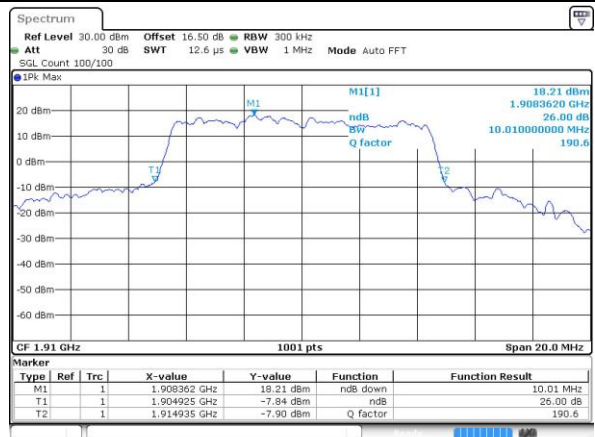

Date: 12 DEC 2018 14:07:39



LTE Band 25

Lowest Channel / 15MHz / QPSK

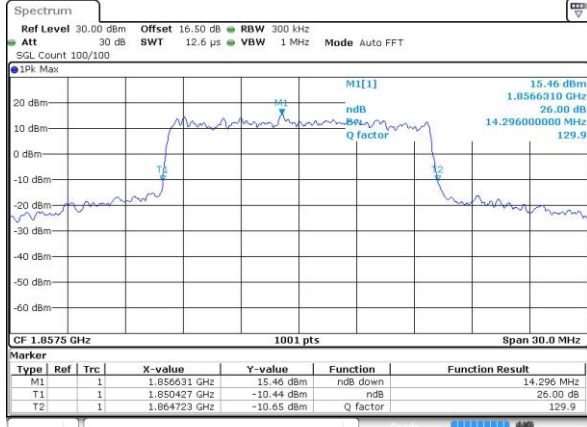

Date: 12 DEC 2018 14:12:15

Lowest Channel / 15MHz / 16QAM

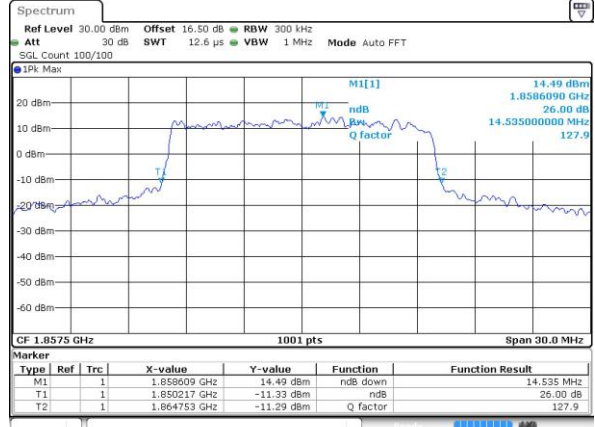

Date: 12 DEC 2018 14:12:26

Middle Channel / 15MHz / QPSK

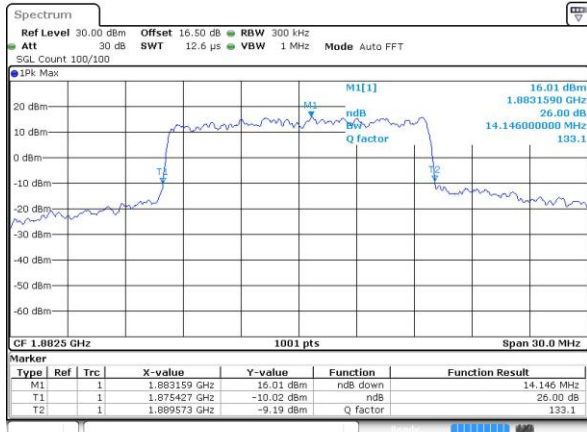

Date: 12 DEC 2018 15:35:49

Middle Channel / 15MHz / 16QAM

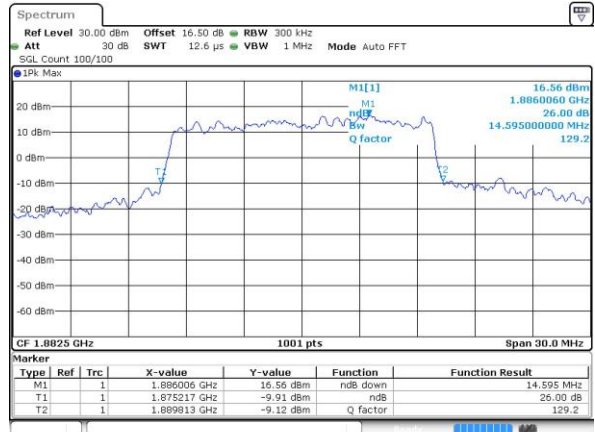

Date: 12 DEC 2018 15:36:01

Highest Channel / 15MHz / QPSK

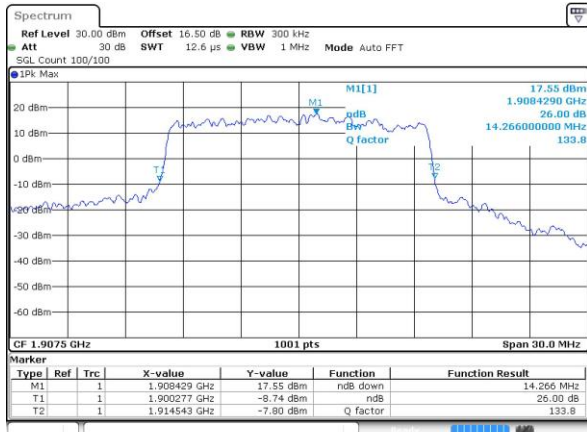

Date: 12 DEC 2018 14:18:59

Highest Channel / 15MHz / 16QAM

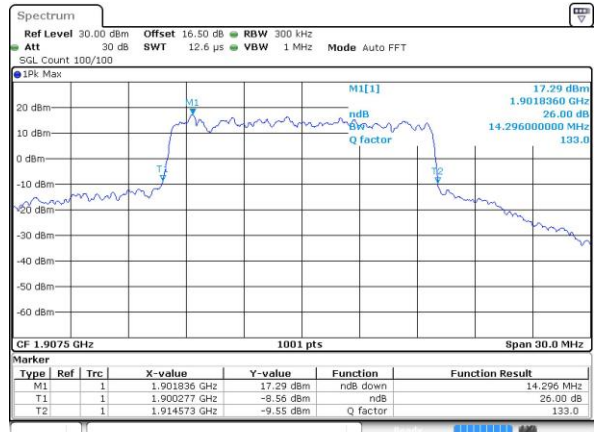

Date: 12 DEC 2018 14:18:48



LTE Band 25

Lowest Channel / 20MHz / QPSK

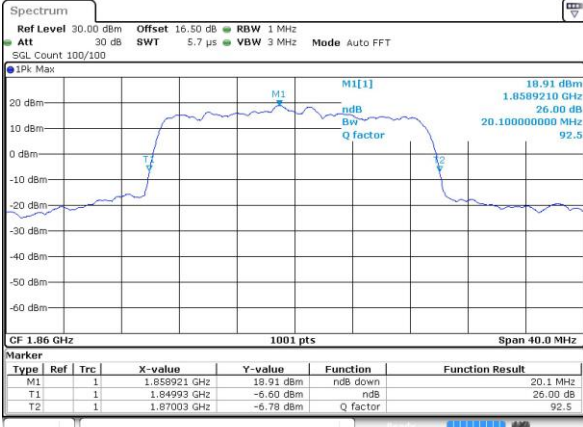

Date: 12 DEC 2018 14:23:58

Lowest Channel / 20MHz / 16QAM

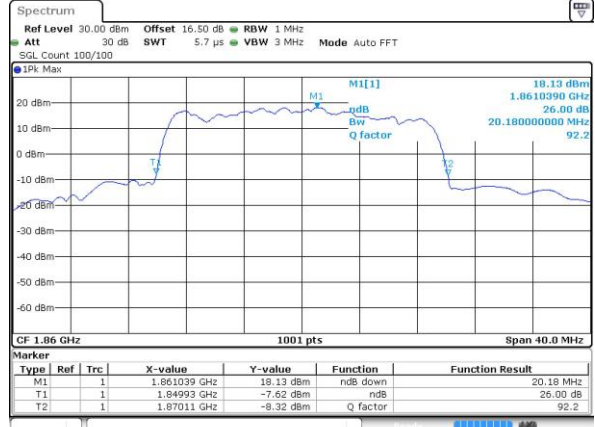

Date: 12 DEC 2018 14:24:09

Middle Channel / 20MHz / QPSK



Date: 12 DEC 2018 15:38:06

Middle Channel / 20MHz / 16QAM

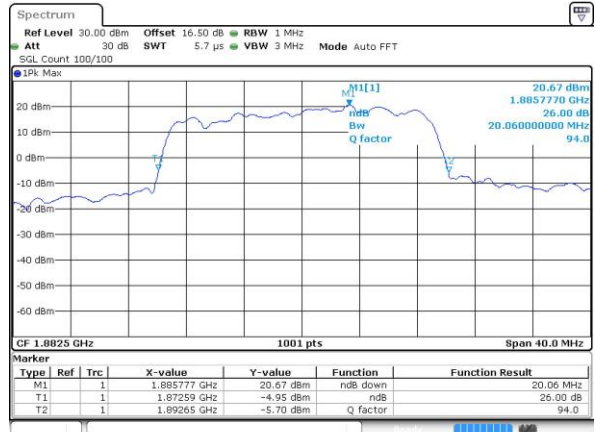

Date: 12 DEC 2018 15:38:17

Highest Channel / 20MHz / QPSK



Date: 12 DEC 2018 14:30:43

Highest Channel / 20MHz / 16QAM

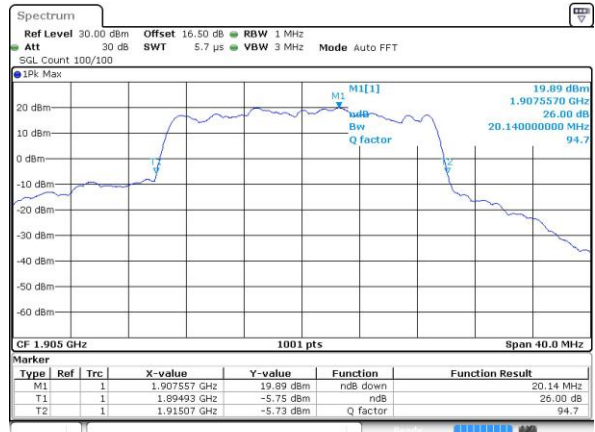

Date: 12 DEC 2018 14:30:31



Occupied Bandwidth

Mode	LTE Band 25 : 99%OBW(MHz)											
	1.4MHz		3MHz		5MHz		10MHz		15MHz		20MHz	
BW	QPSK	16QAM	QPSK	16QAM	QPSK	16QAM	QPSK	16QAM	QPSK	16QAM	QPSK	16QAM
Mod.	QPSK	16QAM	QPSK	16QAM	QPSK	16QAM	QPSK	16QAM	QPSK	16QAM	QPSK	16QAM
Lowest CH	-	-	-	-	4.52	4.55	9.11	9.07	13.40	13.40	18.46	18.38
Middle CH	-	-	-	-	4.52	4.52	9.09	9.05	13.43	13.55	18.26	18.34
Highest CH	-	-	-	-	4.52	4.51	9.03	8.97	13.43	13.34	18.22	18.34



LTE Band 25

Lowest Channel / 5MHz / QPSK

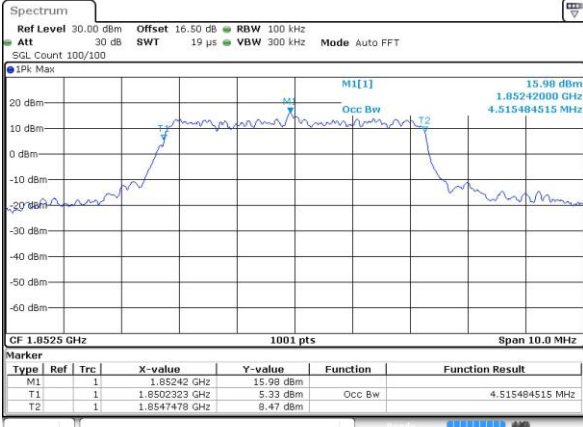

Date: 12 DEC 2018 13:49:51

Lowest Channel / 5MHz / 16QAM

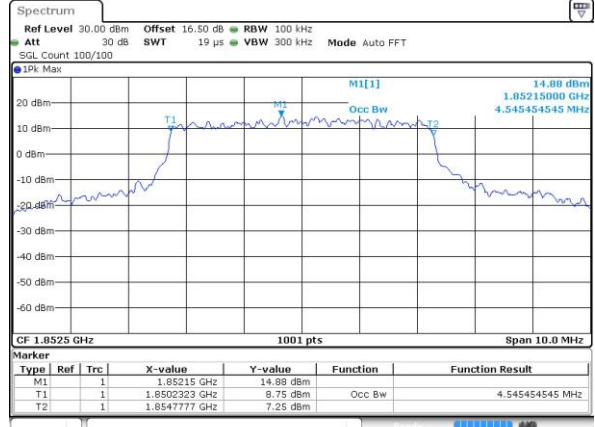

Date: 12 DEC 2018 13:50:03

Middle Channel / 5MHz / QPSK

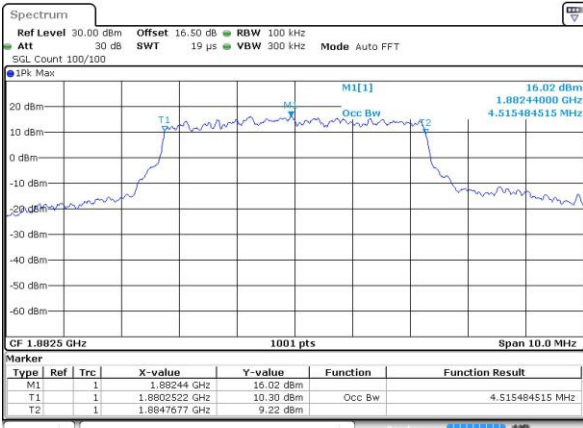

Date: 12 DEC 2018 15:30:54

Middle Channel / 5MHz / 16QAM

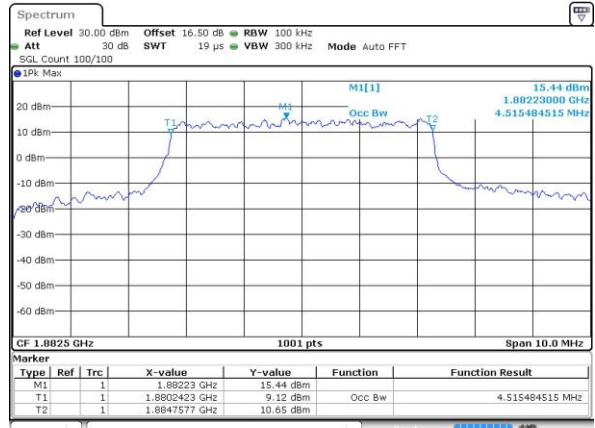

Date: 12 DEC 2018 15:31:05

Highest Channel / 5MHz / QPSK

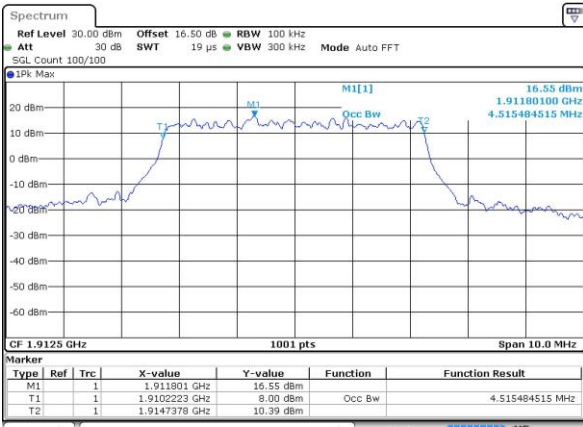

Date: 12 DEC 2018 13:56:25

Highest Channel / 5MHz / 16QAM

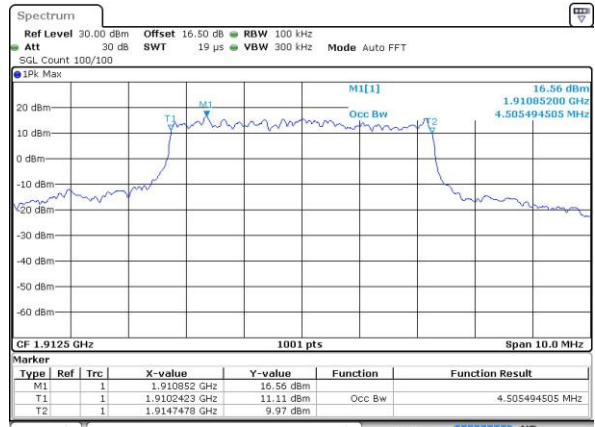

Date: 12 DEC 2018 13:56:37



LTE Band 25

Lowest Channel / 10MHz / QPSK

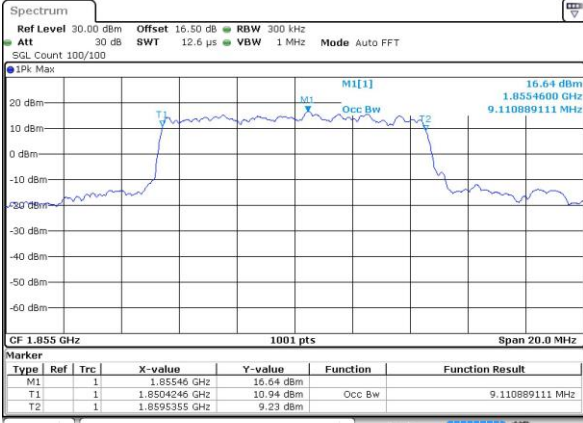

Date: 12 DEC 2018 14:00:43

Lowest Channel / 10MHz / 16QAM

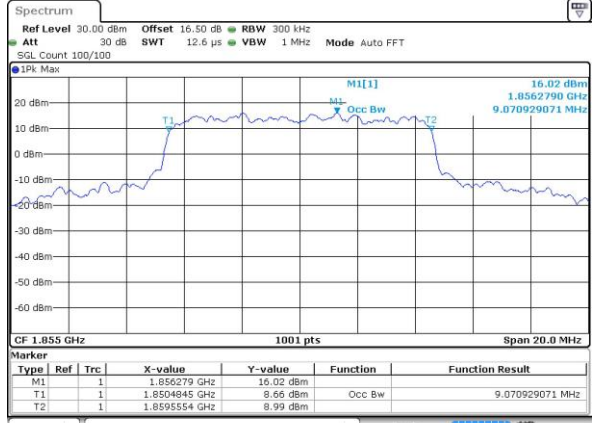

Date: 12 DEC 2018 14:00:55

Middle Channel / 10MHz / QPSK

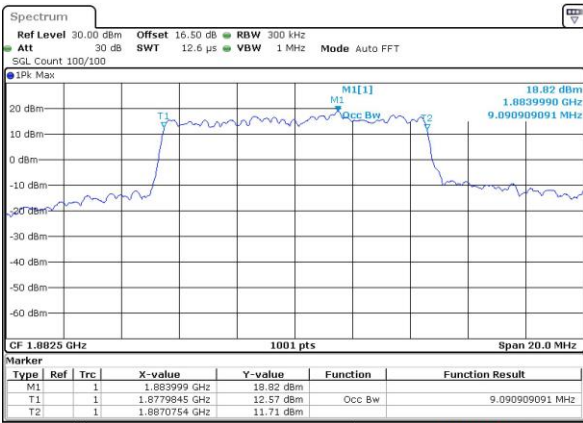

Date: 12 DEC 2018 15:33:10

Middle Channel / 10MHz / 16QAM

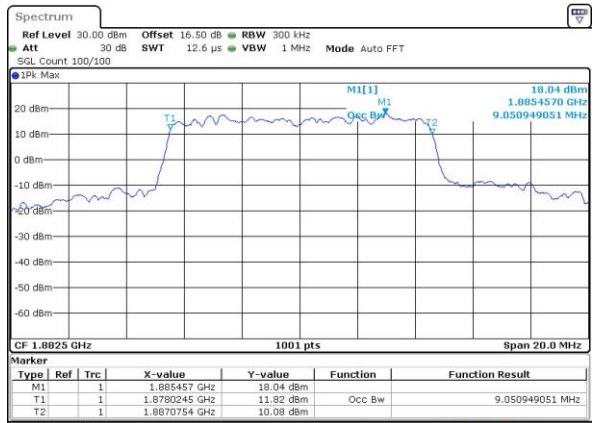

Date: 12 DEC 2018 15:33:22

Highest Channel / 10MHz / QPSK

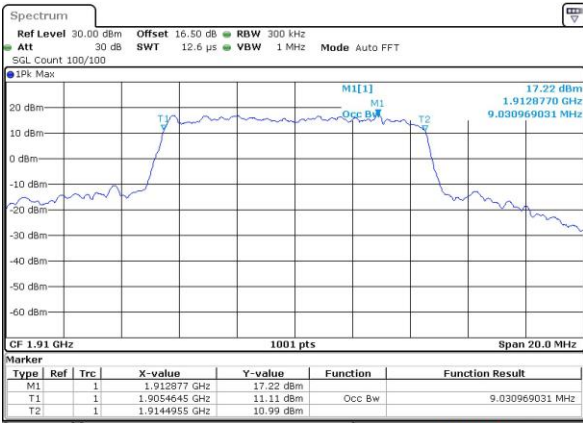

Date: 12 DEC 2018 14:07:17

Highest Channel / 10MHz / 16QAM

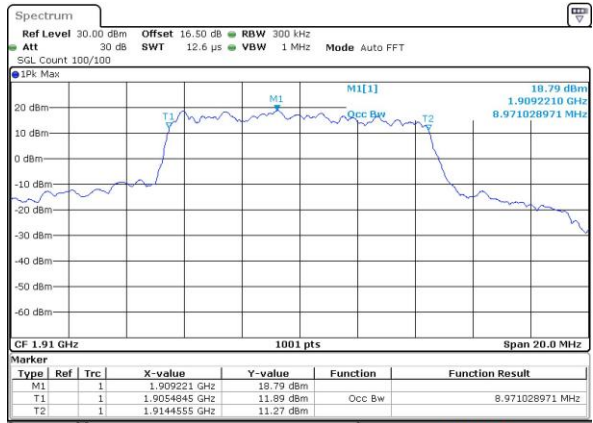

Date: 12 DEC 2018 14:07:28



LTE Band 25

Lowest Channel / 15MHz / QPSK

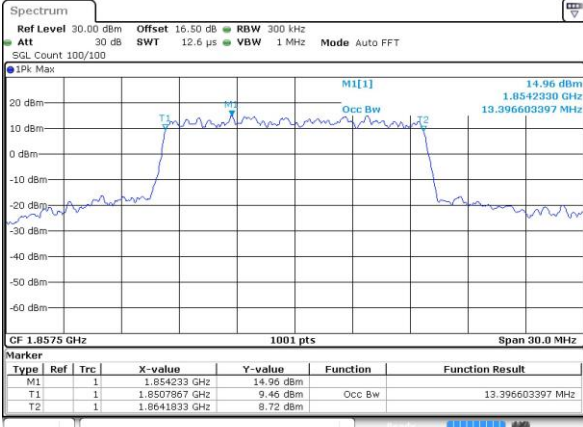

Date: 12 DEC 2018 14:11:52

Lowest Channel / 15MHz / 16QAM

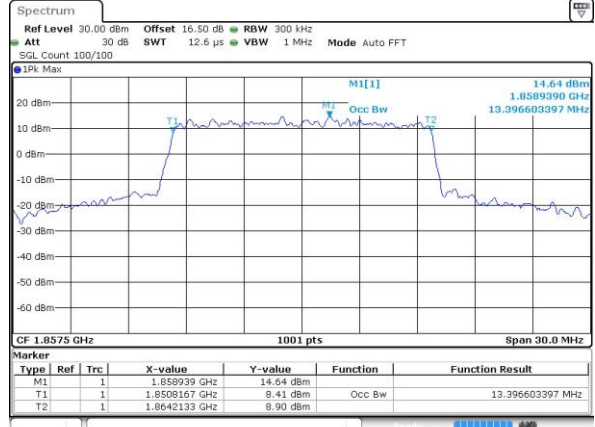

Date: 12 DEC 2018 14:12:03

Middle Channel / 15MHz / QPSK

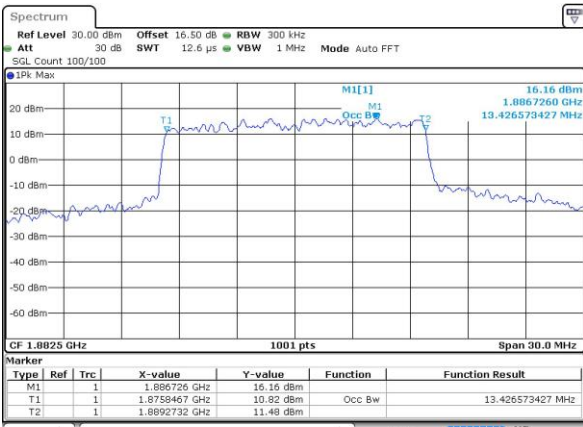

Date: 12 DEC 2018 15:35:27

Middle Channel / 15MHz / 16QAM

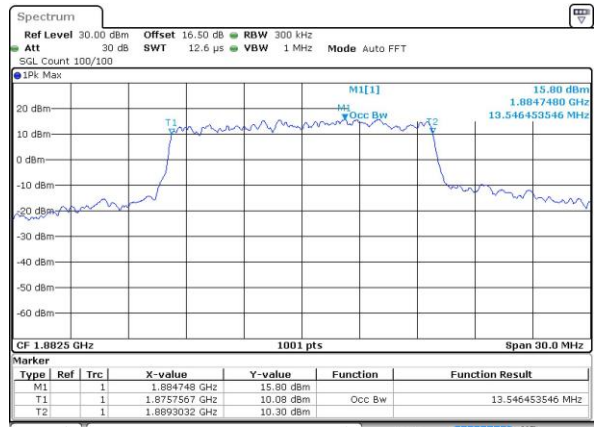

Date: 12 DEC 2018 15:35:38

Highest Channel / 15MHz / QPSK

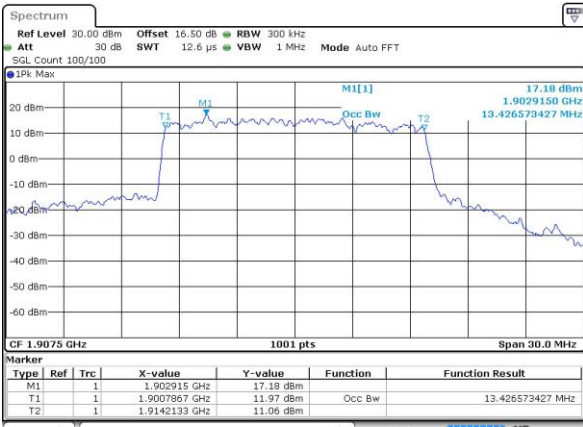

Date: 12 DEC 2018 14:18:25

Highest Channel / 15MHz / 16QAM

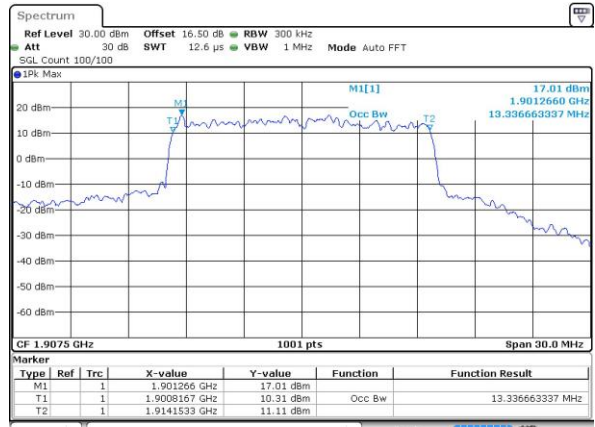

Date: 12 DEC 2018 14:18:36



LTE Band 25

Lowest Channel / 20MHz / QPSK

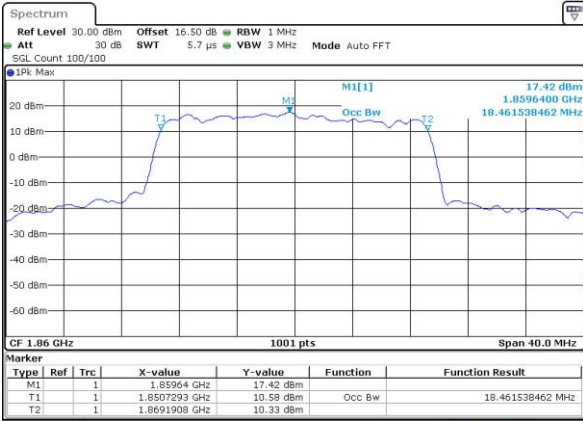

Date: 12 DEC 2018 14:23:35

Lowest Channel / 20MHz / 16QAM

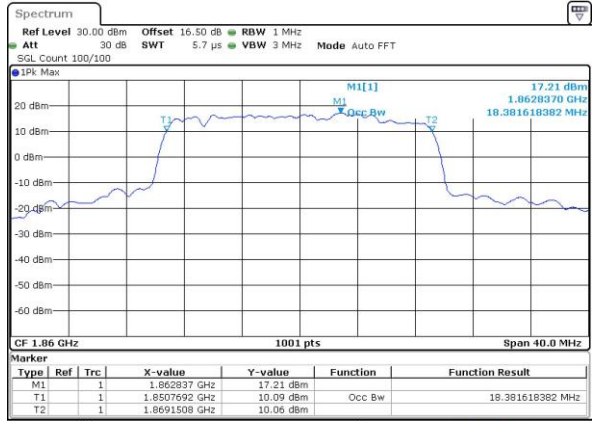

Date: 12 DEC 2018 14:23:46

Middle Channel / 20MHz / QPSK

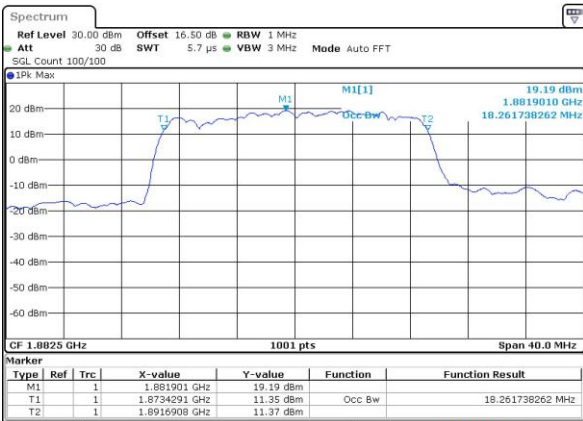

Date: 12 DEC 2018 15:37:43

Middle Channel / 20MHz / 16QAM

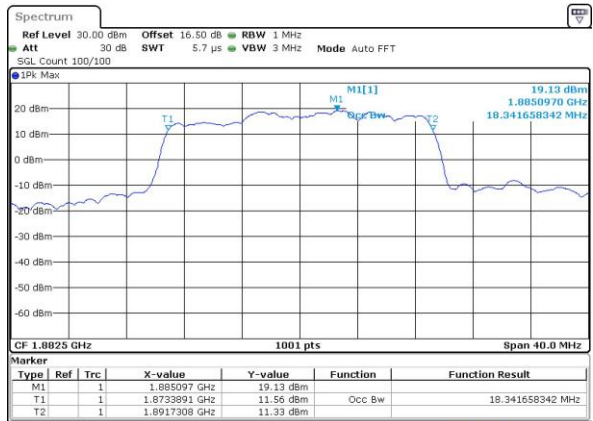

Date: 12 DEC 2018 15:37:55

Highest Channel / 20MHz / QPSK

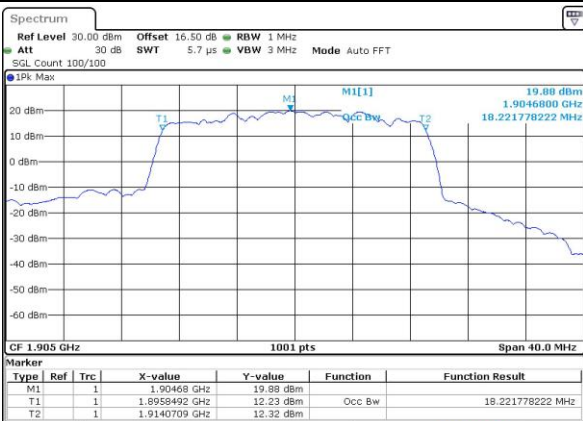

Date: 12 DEC 2018 14:30:08

Highest Channel / 20MHz / 16QAM

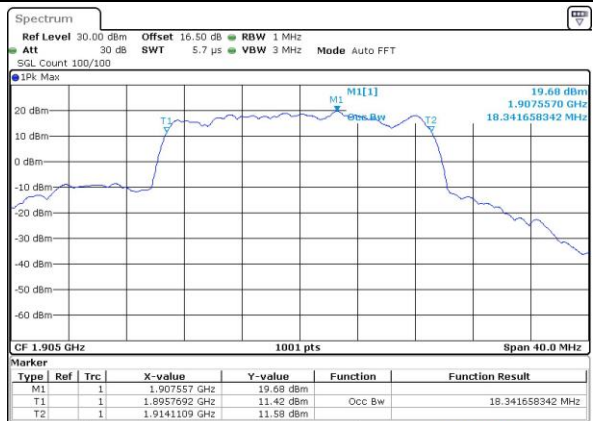

Date: 12 DEC 2018 14:30:20



Conducted Band Edge



LTE Band 25 / 5MHz / QPSK

Lowest Band Edge / 1 RB

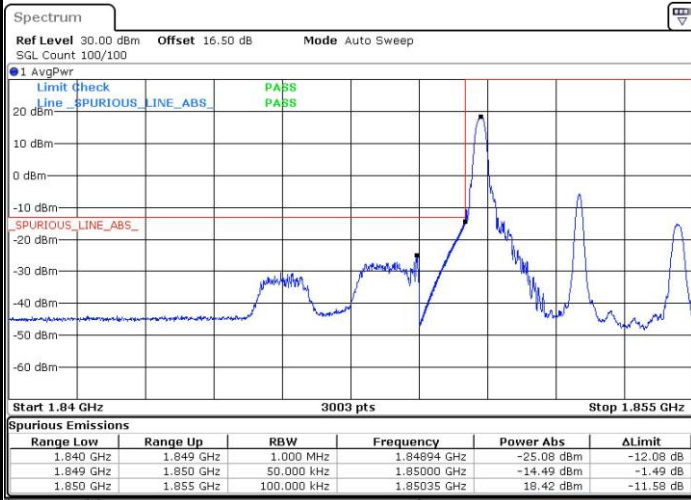

Date: 12 DEC 2018 13:50:56

Highest Band Edge / 1 RB

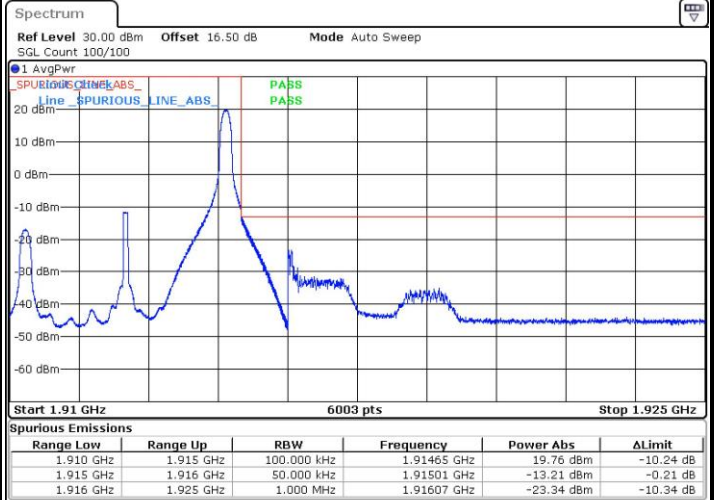

Date: 12 DEC 2018 18:03:18

Lowest Band Edge / Full RB



Date: 12 DEC 2018 13:51:56

Highest Band Edge / Full RB



Date: 12 DEC 2018 13:57:30



LTE Band 25 / 5MHz / 16QAM

Lowest Band Edge / 1RB

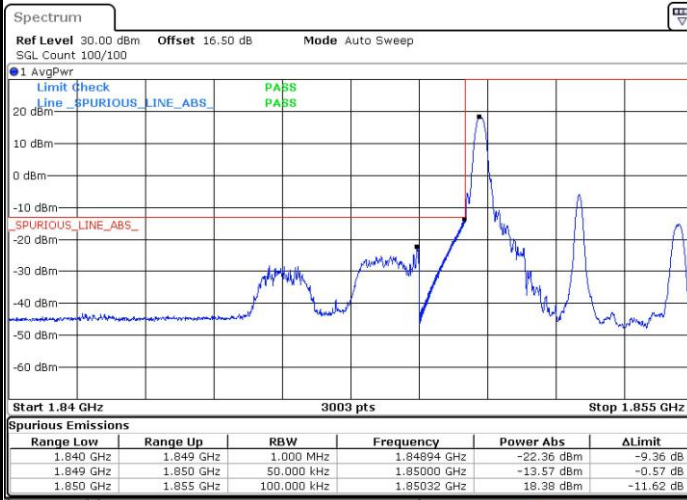

Date: 12.DEC.2018 13:51:26

Highest Band Edge / 1 RB

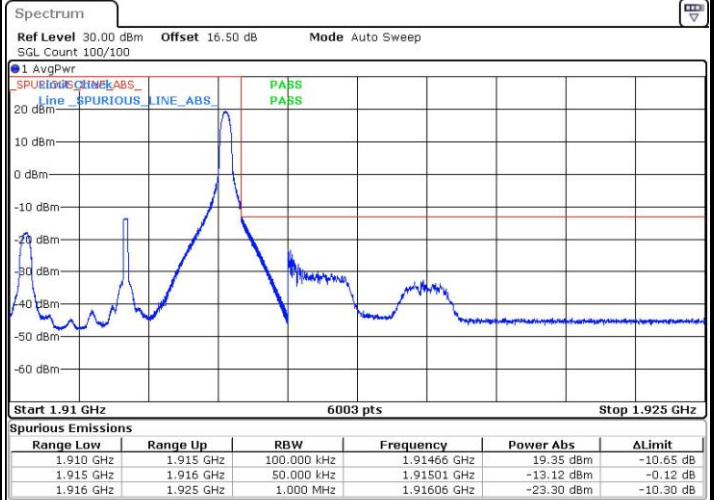

Date: 12.DEC.2018 18:08:25

Lowest Band Edge / Full RB

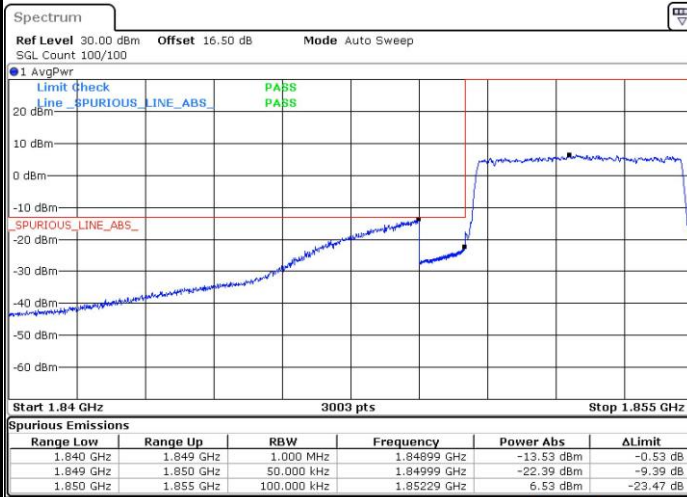

Date: 12.DEC.2018 13:52:26

Highest Band Edge / Full RB



Date: 12.DEC.2018 13:58:00



LTE Band 25 / 10MHz / QPSK

Lowest Band Edge / 1 RB

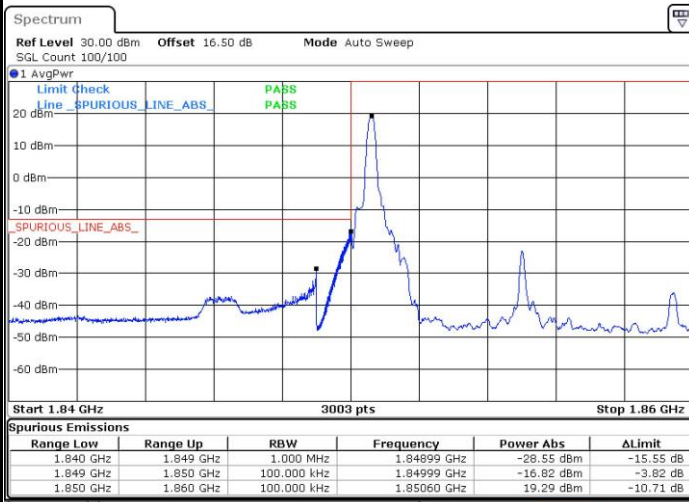

Date: 12 DEC 2018 14:01:47

Highest Band Edge / 1 RB



Date: 12 DEC 2018 14:10:09

Lowest Band Edge / Full RB

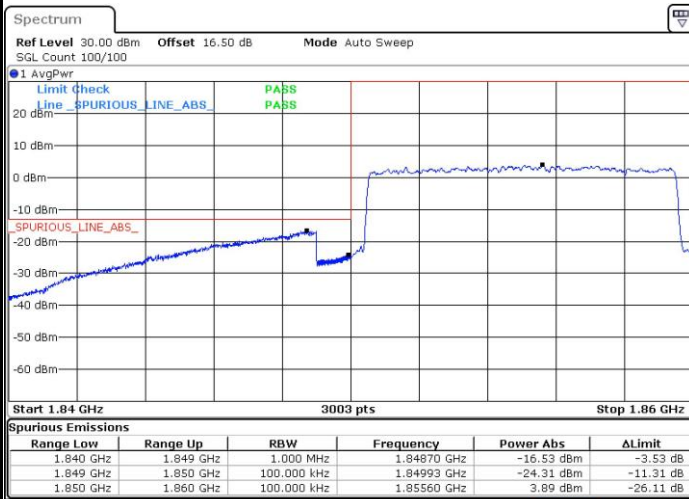

Date: 12 DEC 2018 14:02:47

Highest Band Edge / Full RB

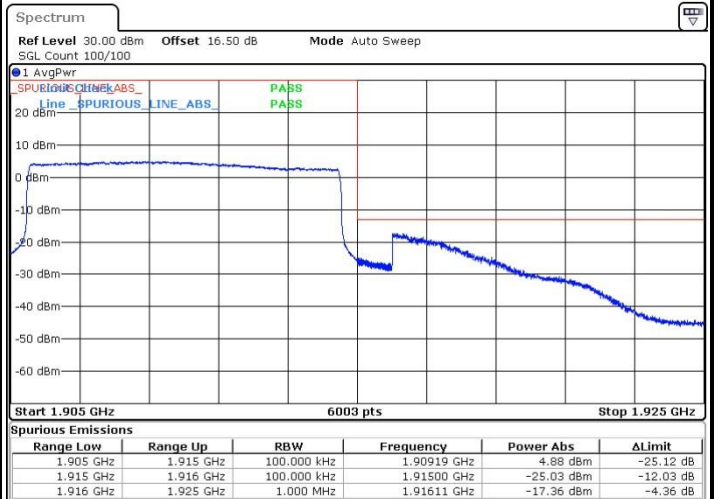

Date: 12 DEC 2018 14:08:25



LTE Band 25 / 10MHz / 16QAM

Lowest Band Edge / 1 RB

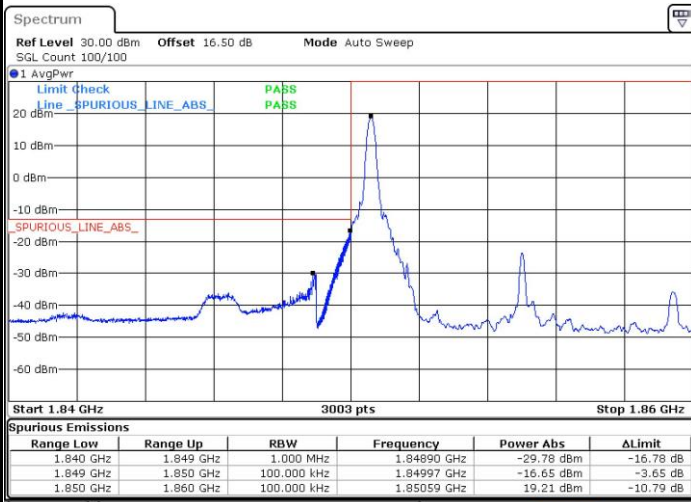

Date: 12.DEC.2018 14:02:17

Highest Band Edge / 1 RB

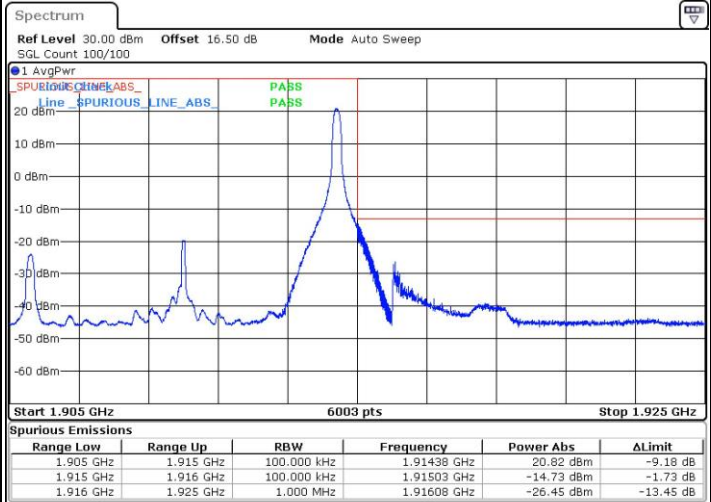

Date: 12.DEC.2018 14:09:34

Lowest Band Edge / Full RB

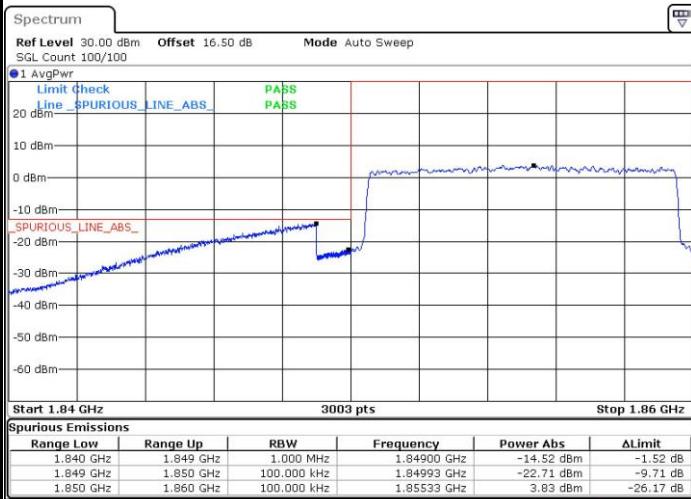

Date: 12.DEC.2018 14:03:17

Highest Band Edge / Full RB

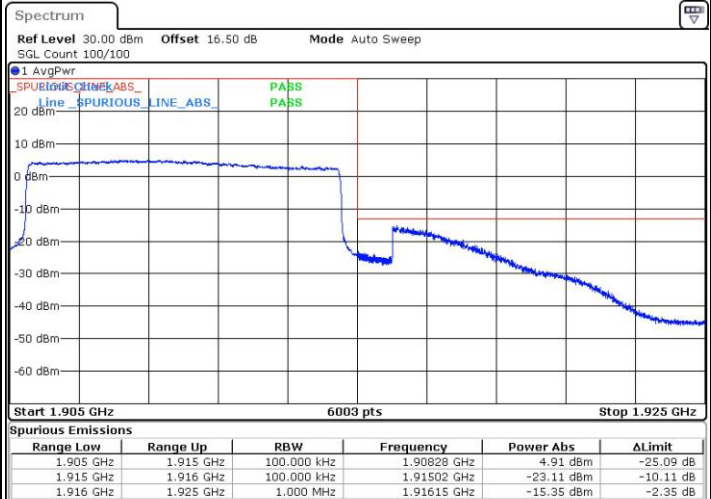

Date: 12.DEC.2018 14:09:00