



OPERATOR'S MANUAL
MANUEL D'UTILISATION
MANUAL DEL OPERADOR
INSPECTION SCOPE
MICROSCOPE D'INSPECTION
LENTE DE INSPECCIÓN CON
TELESCOPIO
ES5000



TABLE OF CONTENTS

- Important Safety Instructions2-3
- Inspection Scope Safety Warnings .3-5
- Symbols.....6
- Features.....7
- Assembly7-8
- Operation.....8-9
- Maintenance..... 10
- Illustrations12-13
- Parts Ordering and Service
 Back page

TABLE DES MATIÈRES

- Avertissements de sécurité générales.....2-3
- Avertissements de sécurité relatifs microscope d'inspection.....3-5
- Symboles.....6
- Caractéristiques7
- Assemblage.....7-8
- Utilisation8-9
- Entretien 10
- Illustrations12-13
- Commande de pièces et dépannage
Page arrière

ÍNDICE DE CONTENIDO

- Advertencias de seguridad para herramientas eléctrica 2-3
- Advertencias de seguridad de inspección con telescopio..... 3-5
- Símbolos.....6
- Características.....7
- Armado 7-8
- Funcionamiento 8-10
- Mantenimiento..... 10-11
- Ilustraciones..... 12-13
- Pedidos de piezas y servicio
Pág. posterior

⚠ WARNING: To reduce the risk of injury, the user must read and understand the operator's manual before using this product.

⚠ AVERTISSEMENT : Pour réduire les risques de blessures, l'utilisateur doit lire et veiller à bien comprendre le manuel d'utilisation avant d'employer ce produit.

⚠ ADVERTENCIA: Para reducir el riesgo de lesiones, el usuario debe leer y comprender el manual del operador antes de usar este producto.

SAVE THIS MANUAL FOR FUTURE REFERENCE

CONSERVER CE MANUEL POUR FUTURE RÉFÉRENCE

GUARDE ESTE MANUAL PARA FUTURAS CONSULTAS

IMPORTANT SAFETY INSTRUCTIONS



WARNING!

READ AND UNDERSTAND ALL INSTRUCTIONS. Failure to follow all instructions listed below, may result in electric shock, fire and/or serious personal injury.



- **Read operator's manual carefully. Learn the applications and limitations, as well as the specific potential hazards, related to this product.** Following this rule will reduce the risk of electric shock, fire, or serious injury.
- **Do not operate battery products in explosive atmospheres, such as in the presence of flammable liquids, gases or dust.** Battery products create sparks which may ignite the dust or fumes.
- **Do not disassemble the product.** Contact with internal parts may increase the risk of electric shock or cause damage to the product.
- **Do not use on a ladder or unstable support.** Stable footing on a solid surface enables better control of the product in unexpected situations.
- **Do not store the product in an area of high heat or humidity. Do not expose the product to extended high heat from the sun (such as on a vehicle dashboard.) To reduce the risk of serious personal injury, do not store outside or in vehicles.** Damage to the product or the battery can result.
- **Do not expose product to rain or wet conditions.** Water entering a product will increase the risk of electric shock.
- **Do not use the inspection scope for diving or any other prolonged underwater use.**
- **The plastic housing is not waterproof. The camera cable is waterproof to 1M.**
- **Use the product in accordance with these instructions and in the manner intended for the product, taking into account the environmental conditions and the work to be performed.** Use of the product for operations different from those intended could result in a hazardous situation.
- **Ensure the product is disconnected and turned off before inserting or changing batteries.**
- **Do not mix old and new batteries or different brands of batteries.**
- **Remove batteries from the accessory device when not in use for an extended time.**
- **Use battery-powered accessory devices only with non-rechargeable alkaline batteries. Always replace the alkaline battery with the same type of alkaline battery.** Use of any other battery packs may create a risk of injury and fire.
- **Under abusive conditions, liquid may be ejected from the battery, avoid contact. If contact accidentally occurs, flush with water. If liquid contacts eyes, additionally seek medical help.** Liquid ejected from the battery may cause irritation or burns.
- **This product should not be used unless the battery compartment is closed.**
- **Do not place battery products or their batteries near fire or heat.** This will reduce the risk of explosion and possibly injury.
- **Do not crush, drop or damage battery. Do not use batteries that have been dropped or received a sharp blow.** A damaged battery is subject to explosion. Properly dispose of a dropped or damaged battery immediately.
- **Batteries can explode in the presence of a source of ignition, such as a pilot light.** To reduce the risk of serious personal injury, never use any battery product in the presence of open flame. An exploded battery can propel debris and chemicals. If exposed, flush with water immediately.
- **Under extreme usage or temperature conditions, battery leakage may occur. If liquid comes in contact with your skin, wash immediately with soap and water. If liquid gets into your eyes, flush them with clean water for at least 10 minutes, then seek immediate medical attention.** Following this rule will reduce the risk of serious personal injury.
- **When servicing the product, use only identical replacement parts. Follow instructions in the Maintenance section of this manual.** Use of unauthorized parts or failure to follow Maintenance instructions may create a risk of shock or injury.
- **Save these instructions.** Refer to them frequently and use them to instruct others who may use this product. If you loan someone this product, loan them these instructions also.

SYMBOLS

The following signal words and meanings are intended to explain the levels of risk associated with this product.

SYMBOL	SIGNAL	MEANING
	DANGER:	Indicates an imminently hazardous situation, which, if not avoided, will result in death or serious injury.
	WARNING:	Indicates a potentially hazardous situation, which, if not avoided, could result in death or serious injury.
	CAUTION:	Indicates a potentially hazardous situation, which, if not avoided, may result in minor or moderate injury.
	NOTICE:	(Without Safety Alert Symbol) Indicates important information not related to an injury hazard, such as a situation that may result in property damage.

Some of the following symbols may be used on this product. Please study them and learn their meaning. Proper interpretation of these symbols will allow you to operate the product better and safer.

SYMBOL	NAME	DESIGNATION/EXPLANATION
	Safety Alert	Indicates a potential personal injury hazard.
	Read Operator's Manual	To reduce the risk of injury, user must read and understand operator's manual before using this product.
V	Volts	Voltage
min	Minutes	Time
—	Direct Current	Type or a characteristic of current

FCC COMPLIANCE

NOTE: This device complies with part 15 of the FCC RULES and Industry Canada license-exempt RSS standard(s). Operation is subject to the following two conditions: (1) this device may not cause harmful interference, and (2) this device must accept any interference received, including interference that may cause undesired operation.









NOTE: The grantee is not responsible for any changes or modifications not expressly approved by the party responsible for compliance. Such modifications could void the user's authority to operate the equipment.

This equipment has been tested and found to comply with the limits for a Class B digital device, pursuant to part 15 of the FCC Rules. These limits are designed to provide reasonable protection against harmful interference in a residential installation. This equipment generates, uses and can radiate radio frequency energy and, if not installed and used in accordance with the instructions, may cause harmful interference to radio communications. However, there is no guarantee that interference will not occur in a particular installation. If this equipment does cause harmful interference to radio or television reception, which can be determined by turning the equipment off and on, the user is encouraged to try to correct the interference by one or more of the following measures:

- Reorient or relocate the receiving antenna.
- Increase the separation between the equipment and receiver.
- Connect the equipment into an outlet on a circuit different from that to which the receiver is connected.
- Consult the dealer or an experienced radio/TV technician for help

Under Industry Canada regulations, this radio transmitter may only operate using an antenna of a type and maximum (or lesser) gain approved for the transmitter by Industry Canada. To reduce potential radio interference to other users, the antenna type and its gain should be so chosen that the equivalent isotropically radiated power (e.i.r.p.) is not more than that necessary for successful communication.

ICON GUIDE

ICON	ICON	FUNCTION
	HISTORY	Indicates the common history for all modules
	MAP	
	HOME PAGE	
	NOTES	Include text, audio and image snap. It also displays the current geo location.
	SHARING	
	SETTINGS	
	CHARGE LEVEL	Battery charge level of accessory device
	CAPTURE MODES	Start and stop (shutter) button for video and snap shot for the camera.
	CAMERA MODE - ON	Tap to activate the camera. Live background will be displayed beneath the overlay when this mode is on.
	CAMERA MODE - OFF	Tap to deactivate the camera. Live background off.
	VIDEO MODE - ON	Tap to activate the video. Live background will be displayed beneath the overlay when this mode is on.
	LASER	Tap to turn the laser on and off

FEATURES

Attaches directly to your phone using the clip (included)

Use a wireless signal to:

- Take pictures of the images captured by the scope, using the RYOBI™ app on your smartphone
- File your measurements, video and pictures
- Share measurements and saved pictures via email and social media
- View dark areas with the 3-stage LED adjustment
- Record a voice note in the image **or video** for later reference
- **Send live video from the scope to your phone**

ASSEMBLY

WARNING:

Do not use this product if it is not completely assembled or if any parts appear to be missing or damaged. Use of a product that is not properly and completely assembled or with damaged or missing parts could result in serious personal injury.

WARNING:

Do not attempt to modify this product or create accessories not recommended for use with this product. Any such alteration or modification is misuse and could result in a hazardous condition leading to possible serious personal injury.

If any parts are damaged or missing, please call 1-877-578-6736 for assistance.

OPERATION

INSTALLING/REPLACING THE AA BATTERIES

Three AAA batteries are preinstalled in the unit. Before first use, remove the pull tab to activate the batteries.

To replace the batteries:

- Slide the battery cover off.
- Install batteries according to the polarity indicators.
- Replace the battery cover, making sure it is secure before use.
- Do not use the product without the battery cover installed.

ATTACHING THE CLIP TO THE INSPECTION SCOPE

The clip is adjustable to accommodate different types of smart phones.

- Align the hook-and-loop sections of the inspection scope to the matching portion of the clip.
- Make sure the two notches match and line up.
- With both thumbs, press the clip in the middle until you hear a “click”.
- Make sure clip is securely attached to the inspection scope.
- Attach your smartphone to the assembled clip and inspection scope.

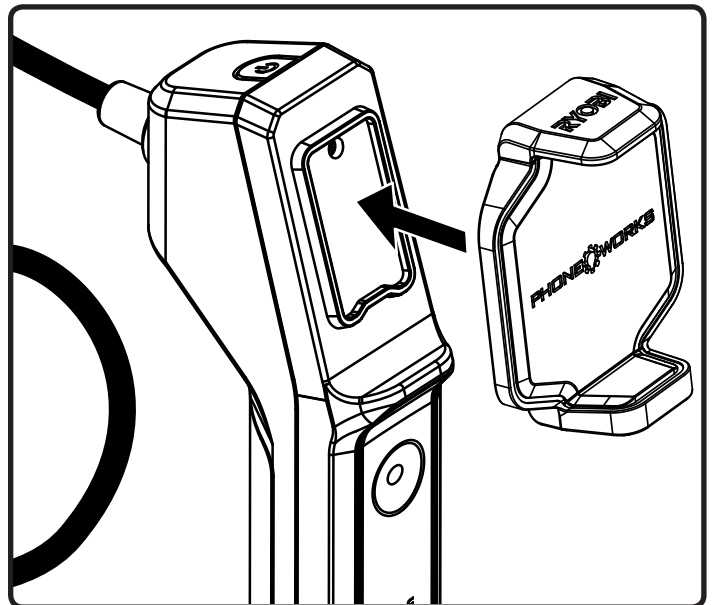
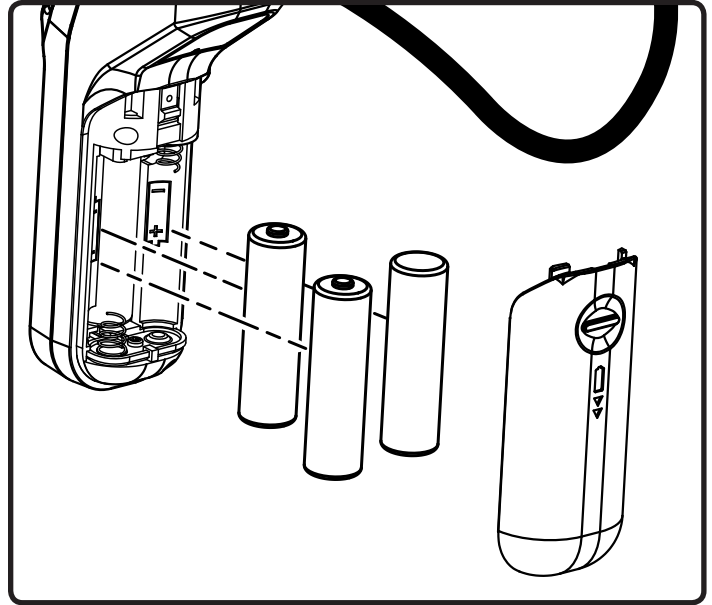

OPERATION

TURNING THE INSPECTION SCOPE ON/OFF

- **To turn the unit ON**, press and hold the power button until the button starts to light up green (~5 seconds).
- The button should begin flashing within a few seconds. When it stops flashing and turns SOLID GREEN, the scope is ready to connect.
- **To turn the unit OFF**, press and hold the power button for ~5 seconds until the button starts a FLASHING RED pattern. It will turn OFF in a few seconds.

ATTACHING THE SMARTPHONE TO THE INSPECTION SCOPE

- Insert the smartphone into the clip and make sure it is securely attached before use.

CONNECTING THE INSPECTION SCOPE WITH YOUR WIRELESS DEVICE

- Turn the unit ON.
- On your phone, turn the WiFi network ON and open to the WiFi connection screen.
- Select the network named “PhoneWorksScope...” with some trailing letters and numbers. Enter the default password 12345678 or the password you have set as described in **Setting a new wireless password**.
- Once the phone indicates that it is connected to the new network, go the Ryobi™ Phone Works™ App on your phone.
- Select and Open the Ryobi™ Phone Works™ App.
- Open the Inspection Scope sub-app. The video feed should start within a few seconds.

NOTE: Your phone may not have internet access while it is connected to the inspection scope.

SETTING A NEW WIRELESS PASSWORD

Setting an individual password is done through the app. A valid password must be from 8 to 63 characters.

- **Turn the unit ON and connect to the PhoneWorksScope... WiFi network.**
- **Open the Ryobi™ Phone Works™ App and the Inspection Scope sub-app.**
- **Click the “Set New Password” icon or “Reset Password” button (See Figure X).**
- **Enter the new password and click OK.**

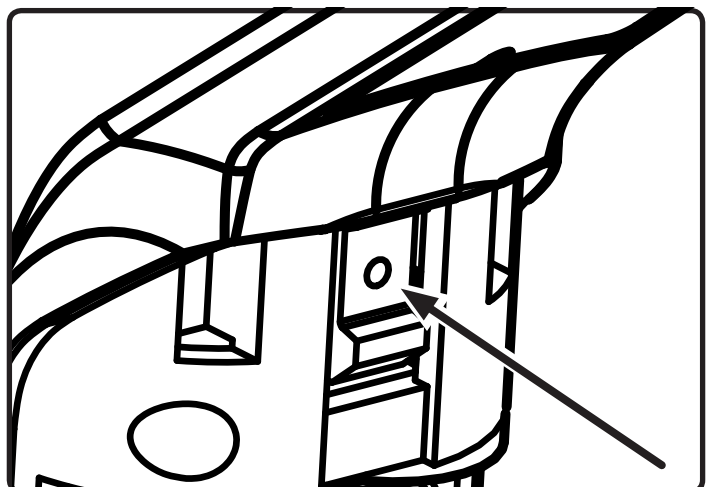
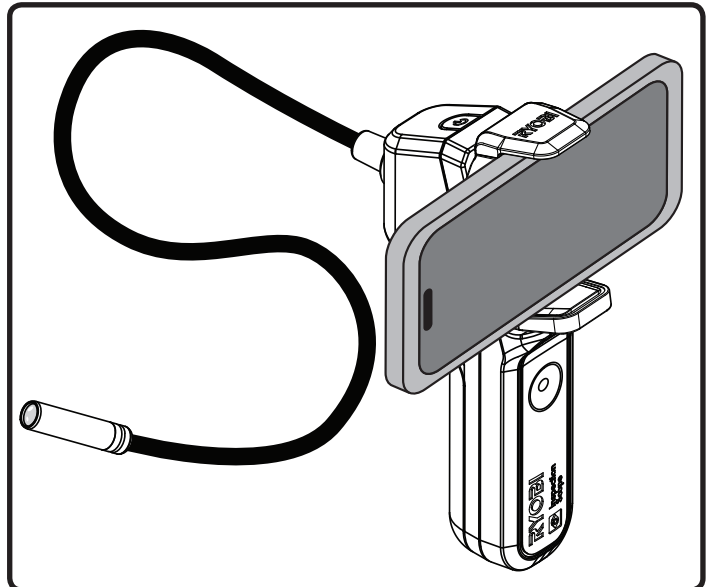
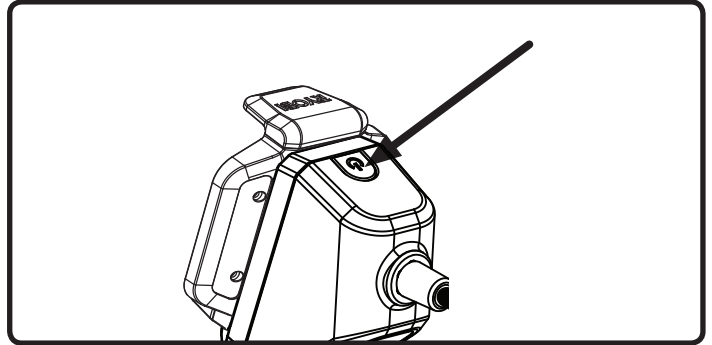

OPERATION

- If the password is accepted, the unit will shut down or reset. After the reset is complete or when the device is turned ON next, the new WiFi password will be in effect.

NOTES:

- The password must be 8 to 63 characters. Valid characters include lower case and upper case English letters, numbers, spaces, and many common special characters.
- If the password is not accepted, the old password will still be in effect. Simply try a different password.
- If your phone is configured to remember WiFi passwords, you may need to update or clear the saved password before your phone can connect to the **PhoneWorksScope...** network with the new password.
- If you forget the password, it can be easily reset back to the default. See procedure, "Resetting to the default password".

RESETTING TO THE **DEFAULT** PASSWORD

- Turn the unit ON.
- Open the battery cover.
- Locate the small hole in the latch.
- Insert a paper clip into the hole and use it to depress the switch inside for ~15 seconds until the unit shuts down or resets.
NOTE: Use a paper clip no more than 1mm in diameter. Larger sizes will not fit and will prevent the clip from pressing the switch.
- The default password (12345678) will be in effect when the unit resets or on next startup of the unit.

INACTIVITY SHUTDOWN (AUTO SHUTDOWN?)

The inspection scope will turn OFF if five minutes pass with no connection from the Ryobi™ Phone Works™ App.

Shutdown occurs when:

- The device is turned ON but nothing is connecting to the WiFi network
- The device is turned ON and a phone is connected to the WiFi network, but the Inspection Scope sub-app is not open.
- The phone goes to sleep or the Ryobi Phone Works™ app is sent to the background.

TAKING A PICTURE

- Aim the scope at the target area.
- Select the camera icon.
- Push the green button to capture the image.
- Swipe downward to delete the picture.
- Swipe left to save the picture in your file cabinet.

TAKING A VIDEO

- Aim the scope.
- Select the video camera icon.
- Push the green button to start recording the video.
- Push the green button again to stop recording.
- Swipe downward to delete the video.
- Swipe left to save the video in your file cabinet.

MAINTENANCE

WARNING:

When servicing, use only identical replacement parts. Use of any other parts could create a hazard or cause product damage.

GENERAL MAINTENANCE

Avoid using solvents when cleaning plastic parts. Most plastics are susceptible to damage from various types of commercial solvents and may be damaged by their use. Use clean cloths to remove dirt, dust, oil, grease, etc.

STORAGE

Store in a cool, dry location to prevent condensation or mold from forming inside the product.

Do not store the inspection scope at temperatures greater than 122° F (such as on a dashboard or vehicle interior).

BATTERY RECYCLING

Consult the Earth 911 website (www.earth911.com) or your local waste authority for information regarding available recycling and/or disposal options.

WARNING:

Do not attempt to destroy or disassemble batteries or remove any of their components. All batteries must be recycled or disposed of properly. Do not discard large amounts of used batteries together. “Dead” batteries often have residual charge. When grouped together, these batteries can become “live” and pose a risk of possible serious injury.

CALIFORNIA PROPOSITION 65

WARNING:

This product may contain chemicals, including lead, known to the State of California to cause cancer, birth defects, or other reproductive harm. ***Wash hands after handling.***

WARRANTY

RYOBI™ Phone Works™ – LIMITED 1 YEAR WARRANTY

One World Technologies, Inc., warrants its RYOBI™ Phone Works™ products with the following conditions:

WHAT THIS WARRANTY COVERS: This warranty covers all defects in workmanship or materials in your RYOBI™ Phone Works™ for a period of one year from the date of purchase.

WHAT'S NOT COVERED: This warranty applies only to the original purchaser at retail and may not be transferred. This warranty only covers defects arising under normal usage and does not cover wearable parts, malfunction, failure or defects resulting from misuse, abuse, neglect, alteration, modification or repairs by other than RYOBI™ Phone Works™ Service Department. One World Technologies, Inc. makes no warranties, representations or promises as to the quality or performance of its power tools other than those specifically stated in this warranty.

HOW TO GET SERVICE: Return the RYOBI™ Phone Works™ Item to Phone Works™ Service Department at the address below, freight prepaid. Insurance is required.

Phone Works™ Service Department
1428 Pearman Dairy Road,
Anderson, SC 29622

When you request warranty service, you must also present proof of purchase documentation, which includes the date of purchase (for example, a bill of sale). We will repair any faulty workmanship, and either repair or replace any defective part, at our option. We will do so without any charge to you. We will complete the work in a reasonable time, but, in any case, within ninety (90) days or less.

For any additional questions or customer service please contact RYOBI™ Phone Works™ at 1-877-578-6736 or by logging on to www.ryobitools.com/phoneworks.

ADDITIONAL LIMITATIONS: Any implied warranties granted under state law, including warranties of merchantability or fitness for a particular purpose, are limited to three years from the date of purchase. One World Technologies, Inc. is not responsible for direct, indirect, or incidental damages, so the above limitations and exclusions may not apply to you. This warranty gives you specific legal rights, and you may also have other rights which vary from state to state.

INSTRUCTIONS IMPORTANTES CONCERNANT LA SÉCURITÉ



AVERTISSEMENT !

LIRE TOUS LES AVERTISSEMENTS ET TOUTES LES INSTRUCTIONS. Le non respect des instructions ci-dessous peut entraîner un choc électrique, un incendie et/ou des blessures graves.



- **Lire le manuel d'utilisation attentivement. Apprendre les applications et les limites, ainsi que les risques spécifiques, liés à ce produit.** Suite à cette règle réduira les risques de choc électrique, un incendie ou des blessures graves.
- **Ne pas utiliser les produits à piles dans des atmosphères explosives, par exemple en présence de liquides, gaz ou poussières inflammables.** Les produits à piles produisent des étincelles risquant d'enflammer les poussières ou vapeurs.
- **Ne démontez pas le produit.** Contact avec les parties internes peut augmenter le risque de choc électrique ou endommager le produit.
- **Ne pas utiliser le produit sur une échelle ou un support instable.** Une bonne tenue et un bon équilibre permettent de mieux contrôler l'outil en cas de situation imprévue.
- **Ne pas ranger outil en par secteur de la chaleur élevée ou d'humidité.** N'exposez pas outil à la chaleur élevée prolongée du soleil (tel que dessus un tableau de bord de véhicule.) Endommagez au produit ou le bloc-pile peut résulter.
- **Ne pas recharger un outil fonctionnant sur piles dans un endroit humide ou mouillé.** Le respect de cette règle réduira les risques de choc électrique.
- **Ne pas utiliser la portée de l'inspection pour la plongée ou tout autre usage prolongé sous l'eau.**
- **Le boîtier en plastique n'est pas étanche.** Le câble de la caméra est étanche à 1M.
- **Utiliser le produit conformément à ces instructions et de la manière prévue pour le produit, en tenant compte des conditions environnementales et du travail à effectuer.** L'utilisation du produit pour des opérations différentes de celles prévues peut entraîner une situation dangereuse.
- **S'assurer que le produit est débranché et éteint avant d'insérer ou de changer les piles.**
- **Ne pas mélanger des piles neuves et usagées ou des piles de marques différentes.**
- **Retirez les piles de l'accessoire lorsqu'il n'est pas utilisé pendant une période prolongée.**
- **Utiliser des appareils alimentés par pile uniquement les accessoires avec des piles alcalines non rechargeables. Toujours remplacer la pile alcaline avec le même type de pile alcaline.** L'utilisation de toute autre pile peut créer un risque de blessure et d'incendie.
- **En cas d'usage abusif, du liquide peut s'échapper des piles. Éviter tout contact avec ce liquide. En cas de contact accidentel, rincer immédiatement les parties atteintes avec de l'eau. En cas d'éclaboussure dans les yeux consulter un médecin.** Le liquide s'échappant des piles peut causer des irritations ou des brûlures.
- **Ce produit ne doit pas être utilisé sans le capuchon de la pile.**
- **Ne pas placer les produits à piles sans fil ou leurs piles à proximité de flammes ou d'une source de chaleur.** Ceci réduira les risques d'explosion et de blessures.
- **Ne pas écraser, faire tomber ou endommager le bloc-piles. Ne jamais utiliser un bloc-piles ou un chargeur qui est tombé, a été écrasé, a reçu un choc violent ou a été endommagé de quelque façon que ce soit.** Une pile endommagée risque d'exploser. Éliminer immédiatement toute pile endommagée, selon une méthode appropriée.
- **Les piles peuvent exploser en présence d'une source d'allumage, telle qu'une veilleuse.** Pour réduire les risques de blessures graves, ne jamais utiliser un appareil sans fil, quel qu'il soit, en présence d'une flamme vive. En explosant, une pile peut projeter des débris et des produits chimiques. En cas d'exposition, rincer immédiatement les parties atteintes avec de l'eau.
- **Si l'outil est utilisé de façon intensive ou sous des températures extrêmes, des fuites de pile peuvent se produire. En cas de contact du liquide avec la peau, rincer immédiatement la partie atteinte avec de l'eau savonneuse. En cas d'éclaboussure dans les yeux, les rincer à l'eau fraîche pendant au moins 10 minutes, puis contacter immédiatement un médecin.** Le respect de cette règle réduira les risques de blessures graves.
- **Utiliser exclusivement des pièces identiques à celles d'origine pour les réparations. Se conformer aux instructions de la section Entretien de ce manuel.** L'usage de pièces non autorisées ou le non-respect des instructions peut présenter des risques de choc électrique ou de blessures.
- **Conserver ces instructions.** Les consulter fréquemment et les utiliser pour instruire les autres utilisateurs éventuels. Si cet produit est prêté, il doit être accompagné de ces instructions.

SYMBOLES

Les termes de mise en garde suivants et leur signification ont pour but d'expliquer le degré de risques associé à l'utilisation de ce produit.

SYMBOLE	SIGNAL	SIGNIFICATION
	DANGER:	Indique une situation extrêmement dangereuse qui, si elle n'est pas évitée, aura pour conséquences des blessures graves ou mortelles.
	AVERTISSEMENT :	Indique une situation potentiellement dangereuse qui, si elle n'est pas évitée, pourrait entraîner des blessures graves ou mortelles.
	ATTENTION :	Indique une situation potentiellement dangereuse qui, si elle n'est pas évitée, pourrait entraîner des blessures légères ou de gravité modérée.
	AVIS :	(Sans symbole d'alerte de sécurité) Indique une information importante ne concernant pas un risque de blessure comme une situation pouvant occasionner des dommages matériels.

Certains des symboles ci-dessous peuvent être utilisés sur l'produit. Veiller à les étudier et à apprendre leur signification. Une interprétation correcte de ces symboles permettra d'utiliser l'produit plus efficacement et de réduire les risques.

SYMBOLE	NOM	DÉSIGNATION / EXPLICATION
	Symbole d'alerte de sécurité	Indique un risque de blessure potentiel.
	Lire le manuel d'utilisation	Toujours porter des lunettes de sécurité munies d'écrans latéraux et un masque facial intégral lors de l'utilisation de cet outil.
V	Volts	Tension
min	Minutes	Temps
==	Courant continu	Type ou caractéristique du courant

CONFORMITÉ AUX NORMES DE LA FEDERAL COMMUNICATIONS COMMISSION (FCC)

NOTE : Cet appareil est conforme à la Partie 15 des Règles FCC et aux normes RSS d'Industrie Canada en matière d'appareils exempts de licence. L'exploitation est autorisée aux deux conditions suivantes : (1) l'appareil ne doit pas produire de brouillage, et (2) l'utilisateur de l'appareil doit accepter tout brouillage radioélectrique subi, même si le brouillage est susceptible d'en compromettre le fonctionnement.









NOTE : Le cessionnaire n'assume aucune responsabilité pour les modifications qui ne sont pas expressément approuvées par la partie responsable de la conformité. Ces modifications pourraient annuler l'autorité de l'utilisateur à utiliser l'équipement.

Après avoir fait subir un essai à l'équipement, il a été déterminé que celui-ci est conforme aux normes relatives à un appareil numérique de classe B, selon la partie 15 des règles de la FCC. Ces normes ont été fixées afin de fournir une protection raisonnable contre une interférence nuisible dans une installation résidentielle. Cet équipement produit et utilise de l'énergie RF. Si l'équipement n'est pas installé et utilisé conformément aux instructions, cela peut causer de l'interférence aux radiocommunications. However, there is no guarantee that interference will not occur in a particular installation. Toutefois, des interférences peuvent se produire dans une installation donnée. Si cet équipement ne produit aucun brouillage préjudiciable à la réception des signaux de radio ou de télévision, ce qui peut être déterminé en allumant et en éteignant l'appareil, on recommande à l'utilisateur de corriger l'interférence par l'une des mesures suivantes :

- Réorienter ou déplacer l'antenne de réception.
- Augmenter l'espacement entre l'équipement et le récepteur.
- Brancher l'équipement dans une prise différente de celle du récepteur.
- Consulter le marchand ou un technicien expérimenté en radiotélédiffusion pour obtenir de l'aide.

Conformément à la réglementation d'Industrie Canada, le présent émetteur radio peut fonctionner avec une antenne d'un type et d'un gain maximal (ou inférieur) approuvé pour l'émetteur par Industrie Canada. Dans le but de réduire les risques de brouillage radioélectrique à l'intention des autres utilisateurs, il faut choisir le type d'antenne et son gain de sorte que la puissance isotrope rayonnée équivalente (p.i.r.e.) ne dépasse pas l'intensité nécessaire à l'établissement d'une communication satisfaisante.

ICON GUIDE

ICON	FUNCTION
	HISTORY Indicates the common history for all modules
	MAP
	HOME PAGE
	NOTES Include text, audio and image snap. It also displays the current geo location.
	SHARING
	SETTINGS
	CHARGE LEVEL Battery charge level of accessory device
	CAPTURE MODES Start and stop (shutter) button for video and snap shot for the camera.
	CAMERA MODE - ON Tap to activate the camera. Live background will be displayed beneath the overlay when this mode is on.
	CAMERA MODE - OFF Tap to deactivate the camera. Live background off.
	VIDEO MODE - ON Tap to activate the video. Live background will be displayed beneath the overlay when this mode is on.
	LASER Tap to turn the laser on and off

CARACTÉRISTIQUES

Attaches directly to your phone using the clip (included)

Use a wireless signal to:

- Take pictures of the images captured by the scope, using the RYOBI™ app on your smartphone
- File your measurements, video and pictures
- Share measurements and saved pictures via email and social media
- View dark areas with the 3-stage LED adjustment
- Record a voice note in the image **or video** for later reference
- **Send live video from the scope to your phone**

ASSEMBLAGE

AVERTISSEMENT :

Ne pas utiliser le produit s'il n'est pas complètement assemblé ou si des pièces semblent manquantes ou endommagées. L'utilisation d'un produit dont l'assemblage est incorrect ou incomplet ou comportant des pièces endommagées ou absentes représente un risque de blessures graves.

AVERTISSEMENT :

Ne pas utiliser le produit s'il n'est pas complètement assemblé ou si des pièces semblent manquantes ou endommagées. L'utilisation d'un produit dont l'assemblage est incorrect ou incomplet ou comportant des pièces endommagées ou absentes représente un risque de blessures graves.

Si des pièces manquent ou sont endommagées, veuillez appeler au 1--877-578-6736 pour obtenir de l'aide.

UTILISATION

INSTALLING/REPLACING THE AA BATTERIES

Three AAA batteries are preinstalled in the unit. Before first use, remove the pull tab to activate the batteries.

To replace the batteries:

- Slide the battery cover off.
- Install batteries according to the polarity indicators.
- Replace the battery cover, making sure it is secure before use.
- Do not use the product without the battery cover installed.

ATTACHING THE CLIP TO THE INSPECTION SCOPE

The clip is adjustable to accommodate different types of smart phones.

- Align the hook-and-loop sections of the inspection scope to the matching portion of the clip.
- Make sure the two notches match and line up.
- With both thumbs, press the clip in the middle until you hear a “click”.
- Make sure clip is securely attached to the inspection scope.
- Attach your smartphone to the assembled clip and inspection scope.

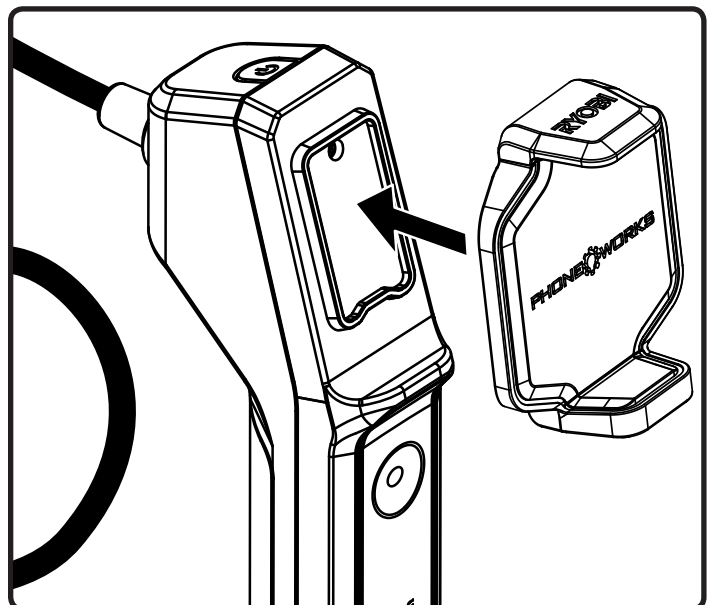
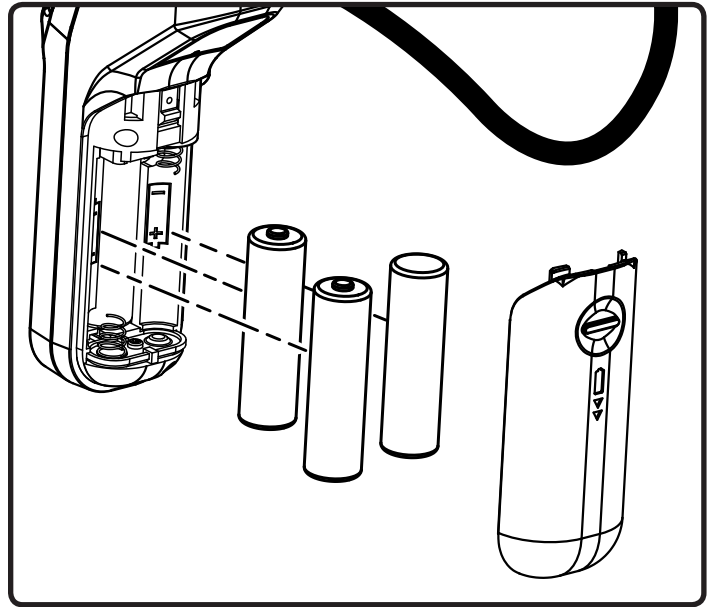

UTILISATION

TURNING THE INSPECTION SCOPE ON/OFF

- **To turn the unit ON**, press and hold the power button until the button starts to light up green (~5 seconds).
- The button should begin flashing within a few seconds. When it stops flashing and turns SOLID GREEN, the scope is ready to connect.
- **To turn the unit OFF**, press and hold the power button for ~5 seconds until the button starts a FLASHING RED pattern. It will turn OFF in a few seconds.

ATTACHING THE SMARTPHONE TO THE INSPECTION SCOPE

- Insert the smartphone into the clip and make sure it is securely attached before use.

CONNECTING THE INSPECTION SCOPE WITH YOUR WIRELESS DEVICE

- Turn the unit ON.
- On your phone, turn the WiFi network ON and open to the WiFi connection screen.
- Select the network named “PhoneWorksScope...” with some trailing letters and numbers. Enter the default password 12345678 or the password you have set as described in **Setting a new wireless password**.
- Once the phone indicates that it is connected to the new network, go the Ryobi™ Phone Works™ App on your phone.
- Select and Open the Ryobi™ Phone Works™ App.
- Open the Inspection Scope sub-app. The video feed should start within a few seconds.

NOTE: Your phone may not have internet access while it is connected to the inspection scope.

SETTING A NEW WIRELESS PASSWORD

Setting an individual password is done through the app. A valid password must be from 8 to 63 characters.

- **Turn the unit ON and connect to the PhoneWorksScope... WiFi network.**
- **Open the Ryobi™ Phone Works™ App and the Inspection Scope sub-app.**
- **Click the “Set New Password” icon or “Reset Password” button (See Figure X).**
- **Enter the new password and click OK.**

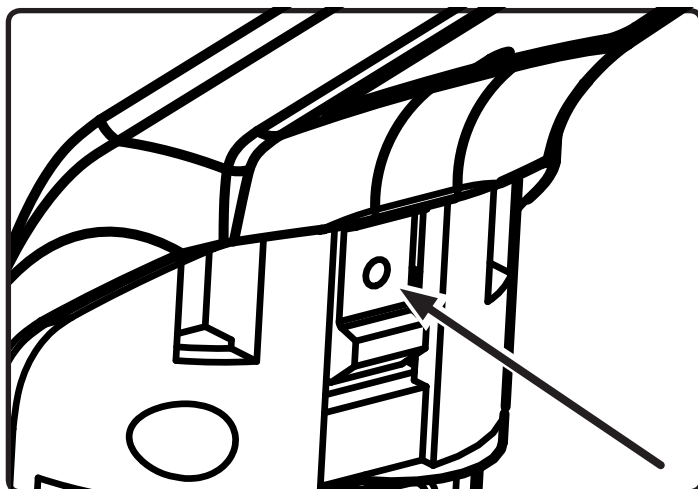
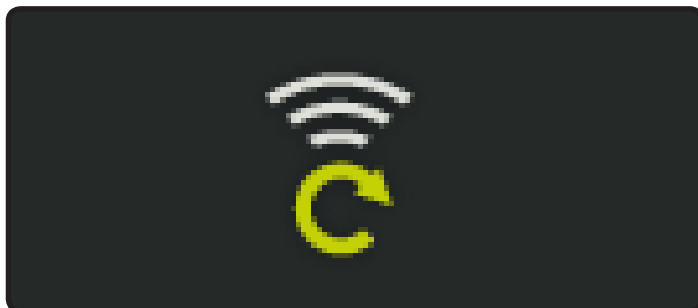
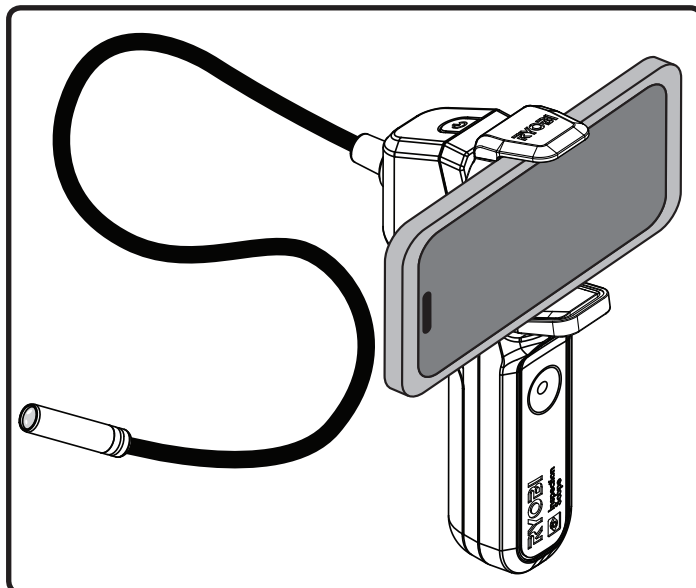
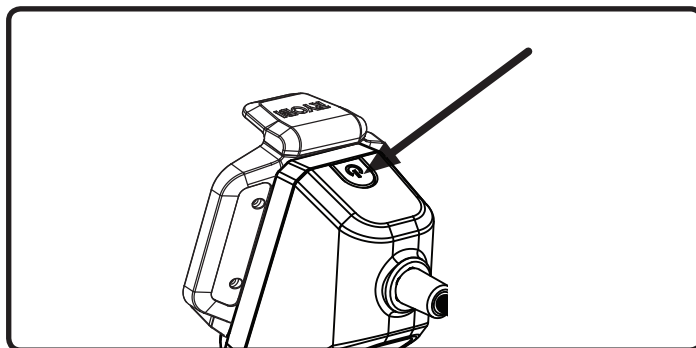

UTILISATION

- If the password is accepted, the unit will shut down or reset. After the reset is complete or when the device is turned ON next, the new WiFi password will be in effect.

NOTES:

- The password must be 8 to 63 characters. Valid characters include lower case and upper case English letters, numbers, spaces, and many common special characters.
- If the password is not accepted, the old password will still be in effect. Simply try a different password.
- If your phone is configured to remember WiFi passwords, you may need to update or clear the saved password before your phone can connect to the **PhoneWorksScope...** network with the new password.
- If you forget the password, it can be easily reset back to the default. See procedure, "Resetting to the default password".

RESETTING TO THE **DEFAULT** PASSWORD

- Turn the unit ON.
- Open the battery cover.
- Locate the small hole in the latch.
- Insert a paper clip into the hole and use it to depress the switch inside for ~15 seconds until the unit shuts down or resets.
NOTE: Use a paper clip no more than 1mm in diameter. Larger sizes will not fit and will prevent the clip from pressing the switch.
- The default password (12345678) will be in effect when the unit resets or on next startup of the unit.

INACTIVITY SHUTDOWN (AUTO SHUTDOWN?)

The inspection scope will turn OFF if five minutes pass with no connection from the Ryobi™ Phone Works™ App.

Shutdown occurs when:

- The device is turned ON but nothing is connecting to the WiFi network
- The device is turned ON and a phone is connected to the WiFi network, but the Inspection Scope sub-app is not open.
- The phone goes to sleep or the Ryobi Phone Works™ app is sent to the background.

TAKING A PICTURE

- Aim the scope at the target area.
- Select the camera icon.
- Push the green button to capture the image.
- Swipe downward to delete the picture.
- Swipe left to save the picture in your file cabinet.

TAKING A VIDEO

- Aim the scope.
- Select the video camera icon.
- Push the green button to start recording the video.
- Push the green button again to stop recording.
- Swipe downward to delete the video.
- Swipe left to save the video in your file cabinet.

ENTRETIEN

WARNING:

When servicing, use only identical replacement parts. Use of any other parts could create a hazard or cause product damage.

GENERAL MAINTENANCE

Avoid using solvents when cleaning plastic parts. Most plastics are susceptible to damage from various types of commercial solvents and may be damaged by their use. Use clean cloths to remove dirt, dust, oil, grease, etc.

STORAGE

Store in a cool, dry location to prevent condensation or mold from forming inside the product.

Do not store the inspection scope at temperatures greater than 122° F (such as on a dashboard or vehicle interior).

BATTERY RECYCLING

Consult the Earth 911 website (www.earth911.com) or your local waste authority for information regarding available recycling and/or disposal options.

WARNING:

Do not attempt to destroy or disassemble batteries or remove any of their components. All batteries must be recycled or disposed of properly. Do not discard large amounts of used batteries together. “Dead” batteries often have residual charge. When grouped together, these batteries can become “live” and pose a risk of possible serious injury.

PROPOSITION 65 DE L'ÉTAT DE CALIFORNIE

AVERTISSEMENT :

Ce produit peut contenir des produits chimiques, notamment du plomb, identifiés par l'état de Californie comme causes de cancer, de malformations congénitales et d'autres troubles de l'appareil reproducteur. ***Bien se laver les mains après toute manipulation.***

WARRANTY

RYOBI™ Phone Works™ – LIMITED 1 YEAR WARRANTY

One World Technologies, Inc., warrants its RYOBI™ Phone Works™ products with the following conditions:

WHAT THIS WARRANTY COVERS: This warranty covers all defects in workmanship or materials in your RYOBI™ Phone Works™ for a period of one year from the date of purchase.

WHAT'S NOT COVERED: This warranty applies only to the original purchaser at retail and may not be transferred. This warranty only covers defects arising under normal usage and does not cover wearable parts, malfunction, failure or defects resulting from misuse, abuse, neglect, alteration, modification or repairs by other than RYOBI™ Phone Works™ Service Department. One World Technologies, Inc. makes no warranties, representations or promises as to the quality or performance of its power tools other than those specifically stated in this warranty.

HOW TO GET SERVICE: Return the RYOBI™ Phone Works™ Item to Phone Works™ Service Department at the address below, freight prepaid. Insurance is required.

Phone Works™ Service Department
1428 Pearman Dairy Road,
Anderson, SC 29622

When you request warranty service, you must also present proof of purchase documentation, which includes the date of purchase (for example, a bill of sale). We will repair any faulty workmanship, and either repair or replace any defective part, at our option. We will do so without any charge to you. We will complete the work in a reasonable time, but, in any case, within ninety (90) days or less.

For any additional questions or customer service please contact RYOBI™ Phone Works™ at 1-877-578-6736 or by logging on to www.ryobitools.com/phoneworks.

ADDITIONAL LIMITATIONS: Any implied warranties granted under state law, including warranties of merchantability or fitness for a particular purpose, are limited to three years from the date of purchase. One World Technologies, Inc. is not responsible for direct, indirect, or incidental damages, so the above limitations and exclusions may not apply to you. This warranty gives you specific legal rights, and you may also have other rights which vary from state to state.