



# motorola

MOTOROLA PIP12 TRAVEL

DIGITAL AUDIO BABY MONITOR

**For: PIP12 TRAVEL**

**PDF** **User Guide**



## Safety instructions



# WARNING

Strangulation Hazard. Children have STRANGLED in cords. Keep this cord out of the reach of children (more than 1 metre away). Never use extension cords with AC Adaptors. Only use the AC Adaptors provided.

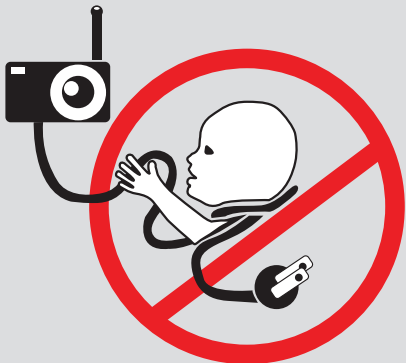

## **Baby monitor setup and use:**

- Determine a location for the baby unit that will allow you to hear your baby in his/her cot.
- Place the baby unit on a flat surface, such as a dresser, bureau, or shelf or mount the unit to a wall securely using the keyhole slots under the stand.
- NEVER place the baby unit or cords within the cot.

### **WARNING**

This digital audio baby monitor is compliant with all relevant standards regarding electromagnetic fields and is, when handled as described in the User Guide, safe to use. Therefore, always read the instructions in this User Guide carefully before using the device.

- Adult assembly is required. Keep small parts away from children when assembling.
- This product is not a toy. Do not allow children to play with it.
- This digital audio baby monitor is not a substitute for responsible adult supervision.
- Keep this User Guide for future reference.
- Keep the cords out of reach of children.
- Do not cover the digital audio baby monitor with a towel or blanket.
- Test this monitor and all its functions so that you are familiar with it prior to actual use.
- Do not use the digital audio baby monitor in damp areas or close to water.
- Do not install the digital audio baby monitor in extreme cold or heat, direct sunlight, or close to a heat source.
- Do not touch the plug contacts with sharp or metal objects.
- Connect the power adaptors to easily accessible mains power.

### **CAUTION**

There is a risk of explosion if the battery is replaced by an incorrect type. Dispose of used batteries according to the instructions.

## 1. Welcome

This booklet provides you the quick start information of your PIP12 TRAVEL. For a full explanation of all features, download the user guide from [motorolanursery.com](http://motorolanursery.com).

## 2. Contents inside the box

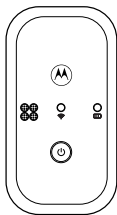

Baby unit

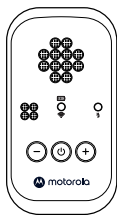

Parent unit

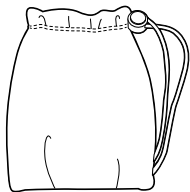

Pouch



USB-C power socket  
with cable x 2



Rechargeable Ni-MH  
AAA battery cells x 4



Quick Start Guide

**Note:** The baby and parent units are attached to each other with magnets. Detach them before first use.

### 3. At a glance

#### Baby unit

Front view

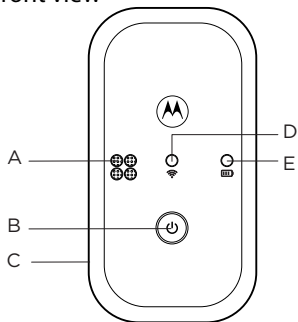

Back view

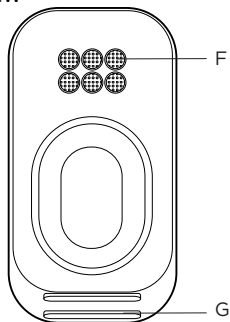

**A Microphone**

**B Power button**

Press and hold to turn the baby unit on or off.

**C Power jack**

**D Power / Linking LED indicator**

It lights up in green when powered on.

**E Battery charging LED indicator**

It lights up in red when the batteries are charging. It flashes red when the batteries are not installed or when the battery level is low.

**F Speaker**

**G Battery compartment**

## Parent unit

### Front view

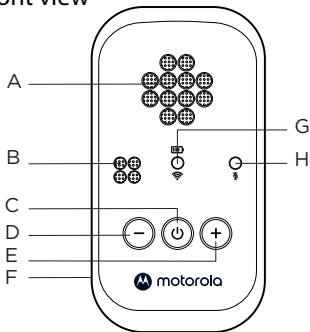

### Back view

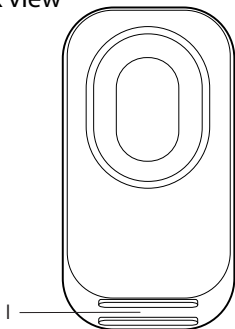

**A Speaker**

**B Microphone**

**C Power button**

Press and hold to turn the parent unit on or off.

**D Volume down / Mute**

Press to decrease the speaker volume. Press and hold to mute the speaker.

**E Volume up / Talk back**

Press to increase the speaker volume. Press and hold to speak to your baby.

**F Power jack**

**G Power / battery charging / Linking LED indicator**

It lights up in red first and becomes green when powered on.

It flashes green when the parent and baby units are not linked with each other.

It lights up in red when the batteries are charging. It flashes red when the batteries are not installed or when the battery level is low.

**H Mute / Sound alert LED indicator**

It flashes red when the speaker is muted or when the parent unit is on mute and a loud sound is detected by the baby unit.

**I Battery compartment**

## 4. Connect and charge

### WARNING

- Use only the approved rechargeable Ni-MH battery cells (2 x AAA Ni-MH rechargeable batteries) supplied with your PIP12 TRAVEL.
- Strangulation Hazard. Children have STRANGLED in cords. Keep adaptor cords out of the reach of children (more than 1 metre away). Never use extension cords with AC adaptors. Only use the AC adaptors provided.

**Note:** When charging the batteries for the first time, charge for at least 16 hours continuously. After charging for the first time, subsequent charging time is about 8 to 10 hours a day. Fully charged batteries should give up to 10 hours use time.

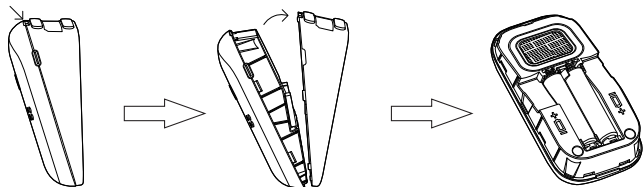

### Baby unit

#### Install batteries

1. Lift up the battery cover to remove it from the baby unit.
2. Insert the rechargeable Ni-MH battery cells supplied. Note the '+' and '-' markings beside the battery compartment and insert in the correct direction.
3. Place the battery cover back into place.

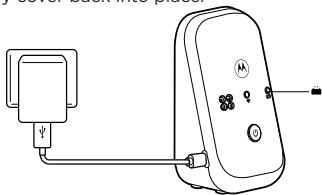

#### Connect the baby unit

1. Plug the DC plug of the power adaptor into the DC jack on the side of the baby unit and plug the other end of the AC adaptor into the AC power outlet.
2. Switch on the AC power (if your AC power outlet has a switch). The battery charging LED indicator lights up in red and turns dim until the batteries are fully charged.

**Note:** If the battery charging LED indicator flashes red when turning on the power button, it means the battery level is low and needs recharging.

## Parent unit

### Install batteries

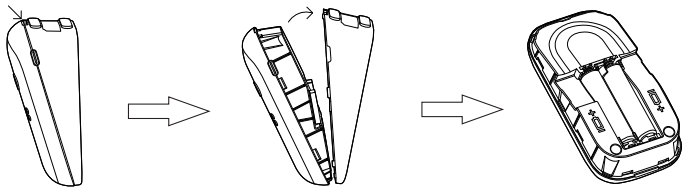

1. Lift up the battery cover to remove it from the parent unit.
2. Insert the rechargeable Ni-MH battery cells supplied. Note the '+' and '-' markings inside the battery compartment and insert in the correct direction.
3. Place the battery cover back into place.

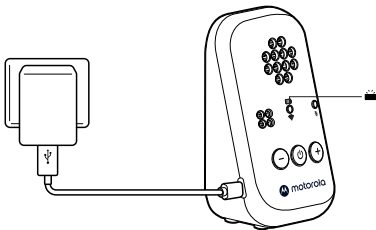

### Connect the parent unit

1. Plug the DC plug of the power adaptor into the DC jack on the side of the parent unit and plug the other end of the AC adaptor into the AC power outlet.
2. Switch on the AC power (if your AC power outlet has a switch). The battery charging LED indicator lights up in red and turns dim until the batteries are fully charged.

**Note:** If the battery charging LED indicator flashes red when turning on the power button, it means the battery level is low and needs recharging. During charging, the parent unit and baby unit should not be attached together.



## 5. Before use

### 5.1 Intended use

Be aware that this Digital Audio Baby Monitor is only intended as an aid. It is not a substitute for responsible and proper adult supervision.

### 5.2 Detach and switch on the parent and baby units

The baby and parent units are attached to each other with magnets. Detach them and make sure the parent and baby units are switched on before first use.



### 5.3 Setup location

- Do not place the baby unit or cords in the crib or within reach of the baby. The unit and cords should be more than 1 meter (3 feet) away from the baby.
- Make sure there is at least 2 meters (6 feet) between the parent and baby (camera) units to avoid audio feedback. If there is noise interference, move the baby and parent units further apart.
- Make sure the parent and baby (camera) units are not placed near other electrical equipment. Move the parent and baby (camera) units 1.5 meters (5 feet) away from other electrical equipment.
- If the baby unit has lost its link with the parent unit, the linking LED indicator on the parent unit flashes green. Move the baby unit closer to the parent unit.

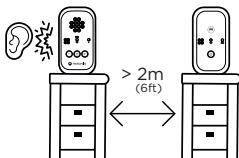
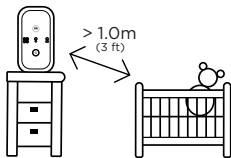

### 5.4 Operating range



The digital audio baby monitor has a range of up to 300 metres (1000 feet) outdoors when there is a clear line of sight between the baby and parent units. Any obstruction between the units will reduce the range significantly.

### 5.5 Check the microphone and speaker



- Speak into the microphone of the baby unit. You should be able to hear the sound from the parent's unit.
- Adjust the speaker volume of the parent unit to the desired volume when necessary.

## 6. Use the digital audio baby monitor

### 6.1 Turn the baby unit on / off

- Press and hold  on the baby unit to turn it on. The power / linking LED indicator lights up in green.
- Press and hold  on the baby unit again to turn it off. The power / linking LED indicator will turn off.

### 6.2 Turn the parent unit on / off

- Press and hold  on the parent unit to turn it on. The power / linking LED indicator lights up in red first and becomes green.
- Press and hold  on the parent unit again to turn it off. You will hear a beep sound. The power / linking LED indicator will turn off.

#### Note

- If you place the parent and baby units too close together, you may hear a high pitched noise. Move the units further apart or decrease the volume of the parent unit.
- If the power / linking LED indicator flashes on the parent unit, they are not linked to each other. Make sure both units are powered on, and the distance between the parent and baby units is less than 300 metres (1000 feet).

### 6.3 Adjust the speaker volume on the parent unit

Press **+** or **-** to increase or decrease the volume. It has 5 volume levels and mute.

### 6.4 Mute the speaker

Press and hold **-** to mute the speaker. The mute / sound alert LED indicator on the parent unit will light up in red.

### 6.5 Sound alert

When the speaker of the parent unit is muted and a loud sound is detected by the baby unit, the mute / sound alert LED indicator will flash red.

### 6.6 Talk back

Press and hold **+** on the parent unit. The power LED indicator flashes green.,. Speak to your baby through the microphone of the parent unit. Release the button when you finish speaking.

## 7. Help

### **The power / linking LED Indicator on the parent unit does not turn on.**

- Check whether the parent unit is powered on.
- Check whether the batteries are correctly installed and not drained.
- Connect the parent unit to the power supply to recharge it.

### **The power / linking LED indicator on the parent unit flashes.**

- The parent unit and the baby unit may be out of range with each other. Reduce the distance between the units. Make sure the distance between the parent unit and baby unit is less than 300 metres (1000 feet).
- The baby unit may be powered off. Press and hold  on the baby unit to power it on.

### **Unable to hear the sound or baby cry from the parent unit.**

- The volume level in the parent unit may be set too low. Increase the volume level of the parent unit. Refer to **section 6.3** for volume level settings.
- The parent unit and the baby unit may be out of range with each other. Make sure the distance between the parent unit and baby unit is less than 300 metres.

### **The Digital Audio Baby Monitor system produces a high-pitched noise.**

- The parent unit and the baby unit are too close with each other. Move the baby and parent units further apart. Make sure the distance between the parent unit and baby unit is less than 300 metres (1000 feet).
- The speaker volume of the parent unit may be set too high. Decrease the volume of the parent unit. Refer to **section 6.3** for volume level settings.

For more support, you can reach us at: [motorolanursery.com/support](http://motorolanursery.com/support) or +1-800-763-2207 (United States and Canada)

## 5. Technical Specifications

RF frequency bands	1881.792 MHz to 1897.344 MHz (Europe) 1921.536 MHz to 1928.448 MHz (USA & Canada)
RF transmission power	< 0.25 W (EU version)
Line of sight operating range between the baby and parent units	300 meters
Power adaptor for the baby and parent units	SHENZHEN BAIJUNDA ELECTRONIC CO. LTD. Model : UT-681A-5100UY Input 100-240V AC 50/60Hz, 200mA Output DC5V 1A  OR  TEN PAO INTERNATIONAL LTD. Model: S005CAU0500100 Input 100-240V AC 50/60Hz, 200mA Output DC5V 1A
Battery	SHENZHEN HIGHPOWER TECHNOLOGY CO. LTD. Model : HFR-AAA750 1.2V 750mAh, AAA  OR  GPI INTERNATIONAL LTD. Model :75AAAHC 1.2V 750mAh, AAA

### Note

Specifications are subject to change without prior notice.

## 6. General information

### Cleaning and care

#### Important

Always switch off and disconnect the power adaptor before cleaning your digital audio baby monitor.

- Clean your digital audio baby monitor with a slightly damp cloth or with an anti-static cloth. Never use cleaning agents or abrasive solvents.
- Do not clean any part of the digital audio baby monitor with thinners or other solvents and chemicals - this may cause permanent damage to the product which is not covered by the warranty.
- Keep your digital audio baby monitor away from hot, humid areas or strong sunlight, and do not let it get wet.
- Every effort has been made to ensure high standards of reliability of your digital audio baby monitor. However, if something does go wrong, please do not try to repair it yourself - contact Customer Service for assistance.

### Disposal of the Device (environment)

At the end of the product life cycle, you should not dispose of this product with normal household waste. Take this product to a collection point for the recycling of electrical and electronic equipment. The symbol on the product, user guide and/or box indicates this. Some of the product materials can be re-used if you take them to a recycling point. By reusing some parts or raw materials from used products you make an important contribution to the protection of the environment. Please contact your local authorities in case you need more information on the collection points in your area. Dispose of the battery pack in an environmentally-friendly manner according to your local regulations.



### Consumer Products and Accessories Warranty

Thank you for purchasing this Motorola branded product manufactured under license by Meizhou Guo Wei Electronics Co. LTD., AD1 section, The economy exploitation area, Meizhou, Guangdong, P.R.China . ("MZGW")

#### What Does this Warranty Cover?

Subject to the exclusions contained below, MZGW warrants that this Motorola branded product ("Product") or certified accessory ("Accessory") sold for use with this product that it manufactured to be free from defects in materials and workmanship under normal consumer usage for the period outlined below. This Limited Warranty is your exclusive warranty and is not transferable.

#### Who is covered?

This warranty extends only to the first consumer purchaser, and is not transferable.

## What will MZGW do?

MZGW or its authorized distributor at its option and within a commercially reasonable time, will at no charge repair or replace any Products or Accessories that do not conform to this limited warranty. We may use functionally equivalent reconditioned / refurbished / pre-owned or new Products, Accessories or parts.

## What Other Limitations Are There?

ANY IMPLIED WARRANTIES, INCLUDING WITHOUT LIMITATION THE IMPLIED WARRANTIES OF MERCHANTABILITY AND FITNESS FOR A PARTICULAR PURPOSE, SHALL BE LIMITED TO THE DURATION OF THIS LIMITED WARRANTY, OTHERWISE THE REPAIR OR REPLACEMENT PROVIDED UNDER THIS EXPRESS LIMITED WARRANTY IS THE EXCLUSIVE REMEDY OF THE CONSUMER, AND IS PROVIDED IN LIEU OF ALL OTHER WARRANTIES, EXPRESS OF IMPLIED. IN NO EVENT SHALL MOTOROLA OR MZGW BE LIABLE, WHETHER IN CONTRACT OR TORT (INCLUDING NEGLIGENCE) FOR DAMAGES IN EXCESS OF THE PURCHASE PRICE OF THE PRODUCT OR ACCESSORY, OR FOR ANY INDIRECT, INCIDENTAL, SPECIAL OR CONSEQUENTIAL DAMAGES OF ANY KIND, OR LOSS OF REVENUE OR PROFITS, LOSS OF BUSINESS, LOSS OF INFORMATION OR OTHER FINANCIAL LOSS ARISING OUT OF OR IN CONNECTION WITH THE ABILITY OR INABILITY TO USE THE PRODUCTS OR ACCESSORIES TO THE FULL EXTENT THESE DAMAGES MAY BE DISCLAIMED BY LAW.

Some jurisdictions do not allow the limitation or exclusion of incidental or consequential damages, or limitation on the length of an implied warranty, so the above limitations or exclusions may not apply to you. This warranty gives you specific legal rights, and you may also have other rights that vary from one jurisdiction to another.

Products Covered	Length of Coverage
Consumer Products	<b>Two (2) years</b> from the date of the products original purchase by the first consumer purchaser of the product.
Consumer Accessories	<b>Ninety (90) days</b> from the date of the accessories original purchase by the first consumer purchaser of the product.
Consumer Products and Accessories that are Repaired or Replaced	<b>The balance of the original warranty or for ninety (90) days</b> from the date returned to the consumer, whichever is longer.

## Exclusions

**Normal Wear and Tear.** Periodic maintenance, repair and replacement of parts due to normal wear and tear are excluded from coverage.

**Abuse & Misuse.** Defects or damage that result from: (a) improper operation, storage, misuse or abuse, accident or neglect, such as physical damage (cracks, scratches, etc.) to the surface of the product resulting from misuse; (b) contact with liquid, water, rain, extreme humidity or heavy perspiration, sand,

dirt or the like, extreme heat, or food; (c) use of the Products or Accessories for commercial purposes or subjecting the Product or Accessory to abnormal usage or conditions; or (d) other acts which are not the fault of Motorola or MZGW are excluded from coverage.

**Use of Non-Motorola branded Products and Accessories.** Defects or damage that result from the use of Non-Motorola branded or certified Products or Accessories or other peripheral equipment are excluded from coverage.

**Unauthorized Service or Modification.** Defects or damages resulting from service, testing, adjustment, installation, maintenance, alteration, or modification in any way by someone other than Motorola, MZGW or its authorized service centers, are excluded from coverage.

**Altered Products.** Products or Accessories with (a) serial numbers or date tags that have been removed, altered or obliterated; (b) broken seals or that show evidence of tampering; (c) mismatched board serial numbers; or (d) nonconforming or non-Motorola branded housings, or parts, are excluded from coverage.

**Communication Services.** Defects, damages, or the failure of Products or Accessories due to any communication service or signal you may subscribe to or use with the Products or Accessories is excluded from coverage.

## How to Obtain Warranty Service or Other Information?

To obtain service or information, please visit us at:  
**[motorolanursery.com/support](http://motorolanursery.com/support)**

You will receive instructions on how to ship the Products or Accessories at your expense and risk, to a MZGW Authorized Repair Center.

To obtain service, you must include: (a) the Product or Accessory; (b) the original proof of purchase (receipt) which includes the date, place and seller of the Product; (c) if a warranty card was included in your box, a completed warranty card showing the serial number of the Product; (d) a written description of the problem; and, most importantly; (e) your address and telephone number.

These terms and conditions constitute the complete warranty agreement between you and MZGW regarding the Products or Accessories purchased by you, and supersede any prior agreement or representations, including representations made in any literature publications or promotional materials issued by MZGW or representations made by any agent, employee or staff of MZGW, that may have been made in connection with the said purchase.

## EU Declaration of Conformity (DoC)

Hereby, MZGW declares that the radio equipment type is in compliance with RE Directive 2014/53/EU. The full text of the EU declaration of conformity is available on the website: [motorolanursery.com](http://motorolanursery.com)

## FCC and IC regulations

### FCC Caution:

Any changes or modifications not expressly approved by the party responsible for compliance could void the user's authority to operate the equipment.

This device complies with part 15 of the FCC Rules. Operation is subject to the following two conditions:

1. this device may not cause harmful interference, and
2. this device must accept any interference received, including interference that may cause undesired operation.

### Important note:

This equipment has been tested and found to comply with the limits for a Class B digital device, pursuant to part 15 of the FCC Rules. These limits are designed to provide reasonable protection against harmful interference in a residential installation. This equipment generates, uses and can radiate radio frequency energy and, if not installed and used in accordance with the instructions, may cause harmful interference to radio communications. However, there is no guarantee that interference will not occur in a particular installation. If this equipment does cause harmful interference to radio or television reception, which can be determined by turning the equipment off and on, the user is encouraged to try to correct the interference by one or more of the following measures:

- Reorient or relocate the receiving antenna.
- Increase the separation between the equipment and receiver.
- Connect the equipment into an outlet on a circuit different from that to which the receiver is connected.
- Consult the dealer or an experienced radio/TV technician for help.

## ISED Warning

This device complies with Innovation, Science, and Economic Development Canada licence-exempt RSS standard(s). Operation is subject to the following two conditions:

1. this device may not cause interference, and
2. this device must accept any interference, including interference that may cause undesired operation of the device.

Le présent appareil est conforme aux CNR d'Innovation, Sciences et Développement économique Canada applicables aux appareils radio exempts de licence. L'exploitation est autorisée aux deux conditions suivantes :

1. l'appareil n' doit pas produire de brouillage, et
2. l'utilisateur de l'appareil doit accepter tout brouillage radioélectrique subi, même si le brouillage est susceptible d'en compromettre le fonctionnement.



### **Radiation Exposure Statement:**

The baby unit complies with FCC/ISED radiation exposure limits set forth for an uncontrolled environment. The baby unit should be installed and operated with minimum distance 20cm between the radiator& your body.

The parent unit has been tested and comply with FCC and ISED SAR limits.

**For face up operation, please hold the device 10mm from your face.**

### **Déclaration d'exposition aux radiations:**

L'unité bébé est conforme aux limites d'exposition aux rayonnements FCC / ISED établies pour un environnement non contrôlé. L'unité bébé doit être installée et utilisée avec une distance minimale de 20 cm entre le radiateur et votre corps.

L'unité parent a été testée et est conforme aux limites SAR FCC et ISED.

**Pour un fonctionnement face vers le haut, tenez l'appareil à 10 mm de votre visage.**

Manufactured, distributed or sold by Meizhou Guo Wei Electronics Co. LTD., official licensee for this product. MOTOROLA and the Stylized M Logo are trademarks or registered trademarks of Motorola Trademark Holdings, LLC. and are used under license. All other trademarks are the property of their respective owners. © 2023 Motorola Mobility LLC. All rights reserved.

Version 1 (EN\_EU&NA)

