

FCC Test Report

(Part 27)

Product Name : 5G Extender Gen 2

Model No : TR2V1

FCC ID : NKR-TR2V1-IDU

Applicant : Wistron Neweb Corporation

Address : 20 Park Avenue II, Hsinchu Science Park, Hsinchu 308, Taiwan

Date of Receipt : 2021/03/04

Issued Date : 2021/06/28

Report No. : 2130168R-E3042110012

Report Version : V1.0



The test results relate only to the samples tested.

The test results shown in the test report are traceable to the national/international standard through the calibration report of the equipment and evaluated measurement uncertainty herein.

This report must not be used to claim product endorsement by TAF or any agency of the government.

The test report shall not be reproduced without the written approval of DEKRA Testing and Certification Co., Ltd.

Measurement uncertainties evaluated for each testing system and associated connections are given here to provide the system information for reference. Compliance determinations do not take into account measurement uncertainties for each testing system, but are based on the results of the compliance measurement.

Test Report

Issued Date : 2021/06/28

Report No.: 2130168R-E3042110012



Product Name : 5G Extender Gen 2
Applicant : Wistron Neweb Corporation
Address : 20 Park Avenue II, Hsinchu Science Park, Hsinchu 308, Taiwan
Manufacturer : Wistron Neweb Corporation
Trade Name : WNC
Model No. : TR2V1
EUT Rated Voltage : AC 102V~138V
EUT Test Voltage : AC 120V
Measurement Standard : FCC CFR Title 47 Part 27
Measurement : FCC CFR Title 47 Part 2
Reference : TIA/EIA 603-E 2016
KDB 971168 D01V03R01
ANSI C63.26 2015
Test Result : Complied

Documented By : Genie Chang
(Senior Project Specialist / Genie Chang)

Tested By : Joe Wang
(Engineer / Joe Wang)

Approved By : wenlee
(Supervisor / Wen Lee)

TABLE OF CONTENTS

Description	Page
1. GENERAL INFORMATION	5
1.1 EUT Description	5
1.2 Antenna List.....	5
1.3 Operational Description.....	6
1.4 Configuration of tested System	7
1.5 EUT Setup Procedures	7
1.6 Test Facility	8
2. Technical Test	9
2.1. Summary of test result	9
2.2. List of test Equipment.....	10
2.3. Measurement Uncertainty	10
3. Conducted Output Power Measurement	11
3.1. Test Specification.....	11
3.2. Test Setup.....	11
3.3. Limits.....	11
3.4. Test Procedure	11
3.5. Test Result of Maximum Power Output.....	12
3.6. Maximum Conducted Power and ERP/EIRP Power.....	14
4. Occupied Bandwidth.....	15
4.1. Test Specification.....	15
4.2. Test Setup.....	15
4.3. Test Procedure	15
4.4. Test Result of Occupied Bandwidth	16
5. Spurious Emission At Antenna Terminals (+/-1MHz).....	25
5.1. Test Specification.....	25
5.2. Setup	25
5.3. Limits.....	25
5.4. Test Procedure	26
5.5. Test Result of Spurious Emission At Antenna Terminals (+/-1MHz)	27
6. Spurious Emission.....	38
6.1. Test Specification.....	38
6.2. Test Setup.....	38
6.3. Limits.....	39
6.4. Test Procedure	39
6.5. Test Result of Spurious Emission	40
7. Frequency Stability Under Temperature & Voltage Variations.....	63
7.1. Test Specification.....	63
7.2. Test Setup.....	63
7.3. Limits.....	63
7.4. Test Procedure	63
7.5. Test Result of Frequency Stability Under Temperature Variations	64
8. Peak to Average Ratio	66
8.1 Test Specification	66
8.1. Test Setup.....	66
8.2. Limits.....	66
8.3. Test Procedure	66
8.4. Test Result of Spurious Emission	67
Attachment 1: EUT Test Photographs	
Attachment 2: EUT Detailed Photographs	

Revision History

Report No.	Version	Description	Issued Date
2130168R-E3042110012	V1.0	Initial issue of report.	2021-06-28

1. GENERAL INFORMATION

1.1 EUT Description

Product Name	5G Extender Gen 2
Model No.	TR2V1
Trade Name	WNC
IMEI No.	357421780000740
FCC ID	NKR-TR2V1-IDU
	LTE Band 4: 1710MHz~1755MHz
	LTE Band 13: 777MHz~787MHz
	LTE Band 4: 2110MHz ~2155MHz
	LTE Band 13: 746MHz ~756MHz
	LTE Band 4: 1.4MHz/3MHz/5MHz/10MHz/15MHz/20MHz
	LTE Band 13: 5MHz/10MHz
Modulation	QPSK/16-QAM
HW Version	V1.0
SW Version	V1.0

1.2 Antenna List

Item	Manufacturer	Part No	Antenna Type	Peak Gain
Main (TX/RX)	WNC	N/A	PIFA	2.23 dBi for B4 1.06 dBi for B13
DIV (RX)			PIFA	4.55 dBi for B4 1.58 dBi for B13

1.3 Operational Description

The EUT provide all functions described as above. The EUT is tested with maximum rated TX power via the Base Station simulator.

DEKRA has verified the construction and function in typical operation. All the test modes were carried out with the EUT in normal operation, which was shown in this test report and defined

as:

Test Mode:	LTE Band 4 QPSK/16-QAM
	LTE Band 13 QPSK/16-QAM

Note:

All operation modes has been verified and the report shows the worst case mode.

1.4 Configuration of tested System

(a) Configuration of Radiated measurement

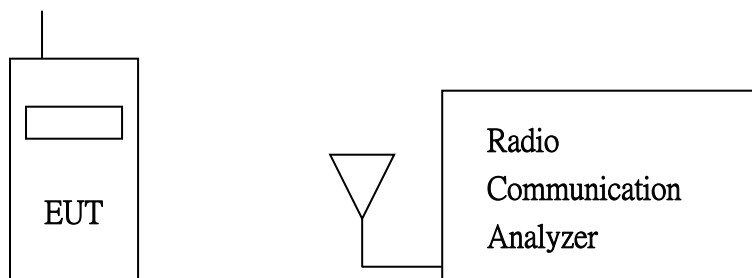

(b) Configuration of Conducted measurement

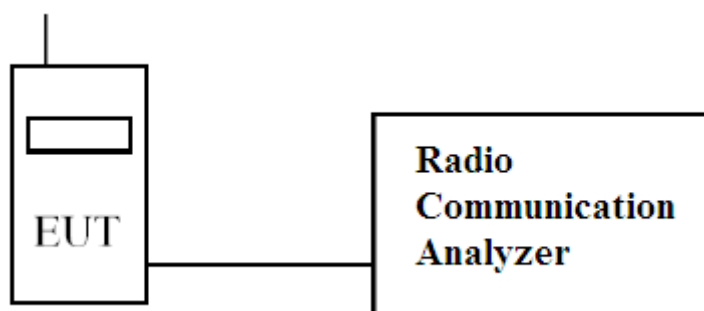

1.5 EUT Setup Procedures

- (1) Setup the EUT and simulators as shown on 1.3
- (2) Turn on the power of all equipments.
- (3) The EUT link with base station and it will continue receive the signal.
- (4) Repeat the above procedure (3).

1.6 Test Facility

Ambient conditions in the laboratory:

Items	Required (IEC 68-1)	Actual	Laboratory
Temperature (°C)	15-35	23 ~ 26	Linkou (Valley)
Humidity (%RH)	25-75	45 ~ 56	Linkou (Valley)

USA : FCC Registration Number: TW3023

Canada : IC Registration Number: 4075A

Site Description: Accredited by TAF
Accredited Number: 3023

Test Laboratory: DEKRA Testing and Certification Co., Ltd
Address: No.5-22, Ruishukeng, Linkou Dist., New Taipei City 24451,
Taiwan, R.O.C.
Phone number: 886-2-8601-3788
Fax number: 886-2-8601-3789
Email address: info.tw@dekra.com
Website: <http://www.dekra.com.tw>

2. Technical Test

2.1. Summary of test result

Test Item	FCC Reference section	FCC Limit	Result
RF Output Power	§2.1046	<3 Watts for §27.50(c)	Pass
	§27.50(c, d)	<1 Watts for §27.50(d)	
Occupied Bandwidth	§2.1049	Within the frequency range	Pass
	§27.53(c, h)		
Spurious Emission at Antenna Terminals	§2.1051	<-13dBm	Pass
	§27.53(c, h)	<-13dBm / <-35dBm for §27.53(c)	
Conducted Emission	§2.1051	<-13dBm	Pass
	§27.53(c, h)		
Field Strength of Spurious Radiation	§2.1053	<-13dBm	Pass
	§27.53(c, h)		
Frequency Stability for Temperature & Voltage	§2.1055	Within the frequency range	Pass
	§27.54		
Peak to Average Ratio	§27.50	<13dB	Pass

2.2. List of test Equipment

Conducted /CTR

Instrument	Manufacturer	Type No.	Serial No	Cal. Date
Spectrum Analyzer	Agilent	N9010A	MY54510357	2021/05/18
Directional coupler	Agilent	87300C	MY44300353	2020/12/03
Directional coupler	Agilent	778D-012	50550	2020/12/03
Standard Temperature & Humidity Chamber	WIT	TH-1S-B	EQ-201-00146	2021/05/18
Communication Tester	R&S	CMW500	157304	2020/12/08

Radiated / Site3

Instrument	Manufacturer	Type No.	Serial No	Cal. Date
Bilog Antenna	Schaffner Chase	CBL6112B	2907	2021/02/26
Horn Antenna	R&S	9120D	556	2021/05/04
Pre-Amplifier	Agilent	87405C	MY55380068	2020/09/10
Spectrum Analyzer	Agilent	N9010A	MY54510357	2021/05/18
Communication Tester	R&S	CMW500	157304	2020/12/08

2.3. Measurement Uncertainty

Conducted Emission

The measurement uncertainty of confidence of 95% is evaluated as ± 1.52 dB

Radiated Emission (Below 1GHz)

The measurement uncertainty of confidence of 95% is evaluated as ± 4.22 dB

Radiated Emission (Above 1GHz)

The measurement uncertainty of confidence of 95% is evaluated as ± 4.08 dB

3. Conducted Output Power Measurement

3.1. Test Specification

According to FCC Part 2.1046, 27.50

3.2. Test Setup

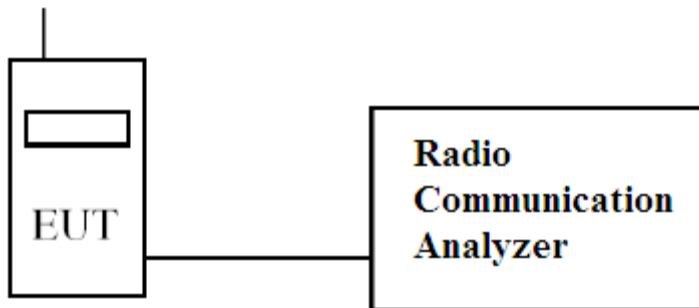

3.3. Limits

Band	Limit
LTE Band 4/1700	EIRP <1W
LTE Band 13/700	ERP <3W

3.4. Test Procedure

The EUT is tested with maximum rated TX power via the Base Station simulator, and the output power was measured at the antenna terminals of the EUT.

3.5. Test Result of Maximum Power Output

Channel	Modulation	LTE Band 4 (1900MHz)							
		RB	RB	Maximum Conducted Output Power					
		No.	Offset	1.4M	3M	5M	10M	15M	20M
Low	QPSK	1	#0	24.07	23.89	23.82	23.89	24.07	23.90
		1	#Mid	24.11	24.18	24.09	23.88	23.94	23.83
		1	#Max	24.02	23.91	23.78	23.83	23.81	23.75
		50%	#0	24.01	22.93	22.79	22.81	22.85	22.87
		50%	#Mid	24.03	22.90	22.83	22.86	22.85	22.70
		50%	#Max	23.93	22.89	22.76	22.76	22.73	22.73
		100%	--	23.01	22.85	22.79	22.79	22.82	22.81
	16QAM	1	#0	22.86	22.72	22.61	22.81	22.79	22.86
		1	#Mid	23.15	23.13	22.83	22.69	22.78	22.85
		1	#Max	22.84	22.89	22.49	22.78	22.61	22.70
		50%	#0	23.01	21.86	21.75	21.81	21.88	21.83
		50%	#Mid	23.03	21.91	21.73	21.84	21.88	21.68
		50%	#Max	22.93	21.88	21.79	21.77	21.79	21.63
		100%	--	21.92	21.81	21.76	21.79	21.86	21.80
Mid	QPSK	1	#0	23.91	23.82	23.70	23.75	23.92	23.81
		1	#Mid	23.98	24.20	24.02	23.82	23.91	23.84
		1	#Max	23.90	23.94	23.84	23.71	23.84	23.69
		50%	#0	23.84	22.81	22.68	22.69	22.81	22.77
		50%	#Mid	23.93	22.90	22.82	22.76	22.84	22.83
		50%	#Max	23.89	22.83	22.88	22.85	22.87	22.71
		100%	--	22.97	22.89	22.77	22.73	22.91	22.78
	16QAM	1	#0	22.88	22.57	22.60	22.69	22.76	22.31
		1	#Mid	22.93	22.97	22.97	22.94	22.73	22.40
		1	#Max	22.82	22.77	22.71	22.78	22.76	22.30
		50%	#0	22.93	21.85	21.63	21.61	21.76	21.71
		50%	#Mid	22.96	21.83	21.86	21.77	21.75	21.73
		50%	#Max	22.78	21.85	21.75	21.79	21.82	21.67
		100%	--	21.82	21.81	21.86	21.75	21.76	21.75
High	QPSK	1	#0	23.76	23.59	23.59	23.72	23.91	23.99
		1	#Mid	23.92	23.82	23.89	23.65	23.63	23.65
		1	#Max	23.87	23.75	23.78	23.89	23.83	23.72
		50%	#0	23.68	22.68	22.62	22.52	22.80	22.88
		50%	#Mid	23.84	22.57	22.79	22.57	22.70	22.66
		50%	#Max	23.81	22.66	22.80	22.62	22.76	22.49
		100%	--	22.88	22.64	22.72	22.70	22.80	22.73
	16QAM	1	#0	22.35	22.35	22.17	22.59	23.04	22.97
		1	#Mid	22.40	22.78	22.60	22.58	22.36	22.52
		1	#Max	22.32	22.69	22.30	22.93	22.82	22.66
		50%	#0	22.60	21.58	21.67	21.50	21.68	21.82
		50%	#Mid	22.74	21.59	21.64	21.54	21.60	21.67
		50%	#Max	22.76	21.65	21.81	21.62	21.68	21.55
		100%	--	21.68	21.57	21.69	21.66	21.73	21.65

Channel	Modulation	LTE Band 13 (700MHz)							
		RB	RB	Maximum Conducted Output Power					
		No.	Offset	1.4M	3M	5M	10M	15M	20M
Low	QPSK	1	#0	--	--	23.97	--	--	--
		1	#Mid	--	--	24.27	--	--	--
		1	#Max	--	--	24.03	--	--	--
		50%	#0	--	--	23.13	--	--	--
		50%	#Mid	--	--	23.15	--	--	--
		50%	#Max	--	--	23.08	--	--	--
		100%	--	--	--	23.17	--	--	--
	16QAM	1	#0	--	--	22.84	--	--	--
		1	#Mid	--	--	23.23	--	--	--
		1	#Max	--	--	23.01	--	--	--
		50%	#0	--	--	22.23	--	--	--
		50%	#Mid	--	--	22.09	--	--	--
		50%	#Max	--	--	22.07	--	--	--
		100%	--	--	--	22.09	--	--	--
Mid	QPSK	1	#0	--	--	23.99	24.03	--	--
		1	#Mid	--	--	24.27	24.16	--	--
		1	#Max	--	--	23.91	24.08	--	--
		50%	#0	--	--	23.08	23.05	--	--
		50%	#Mid	--	--	23.14	23.08	--	--
		50%	#Max	--	--	23.05	23.08	--	--
		100%	--	--	--	23.11	23.05	--	--
	16QAM	1	#0	--	--	22.88	23.07	--	--
		1	#Mid	--	--	23.30	22.92	--	--
		1	#Max	--	--	22.97	23.09	--	--
		50%	#0	--	--	22.16	22.12	--	--
		50%	#Mid	--	--	22.05	22.07	--	--
		50%	#Max	--	--	22.07	22.09	--	--
		100%	--	--	--	22.11	22.10	--	--
High	QPSK	1	#0	--	--	24.01	--	--	--
		1	#Mid	--	--	24.19	--	--	--
		1	#Max	--	--	24.02	--	--	--
		50%	#0	--	--	23.07	--	--	--
		50%	#Mid	--	--	23.09	--	--	--
		50%	#Max	--	--	23.09	--	--	--
		100%	--	--	--	23.06	--	--	--
	16QAM	1	#0	--	--	23.07	--	--	--
		1	#Mid	--	--	23.18	--	--	--
		1	#Max	--	--	23.03	--	--	--
		50%	#0	--	--	22.12	--	--	--
		50%	#Mid	--	--	22.11	--	--	--
		50%	#Max	--	--	22.18	--	--	--
		100%	--	--	--	22.06	--	--	--

3.6. Maximum Conducted Power and ERP/EIRP Power

According to KDB 412172 D01 Section 1.2 Power Approach

$$\text{EIRP} = P_T + G_T - L_C = \text{ERP} + 2.15 \text{ dB}, \text{ERP} = \text{EIRP} - 2.15 \text{ dB}$$

P_T = transmitter output power in dBm

G_T = gain of the transmitting antenna in dBi

L_C = signal attenuation in the connecting cable between the transmitter and antenna in dB

LTE Band	BW	Modulation	Conducted Peak Power (dBm)	Conducted Peak Power (W)	Antenna Gain (dBi)	Maximum EIRP (W)	Maximum EIRP Limit (W)
4	1.4M	QPSK	24.11	0.258	4.55	0.735	1
		16QAM	23.15	0.207	4.55	0.589	1
	3M	QPSK	24.20	0.263	4.55	0.750	1
		16QAM	23.13	0.206	4.55	0.586	1
	5M	QPSK	24.09	0.256	4.55	0.731	1
		16QAM	22.97	0.198	4.55	0.565	1
	10M	QPSK	23.89	0.245	4.55	0.698	1
		16QAM	22.94	0.197	4.55	0.561	1
	15M	QPSK	24.07	0.255	4.55	0.728	1
		16QAM	23.04	0.201	4.55	0.574	1
20M	QPSK	23.99	0.251	4.55	0.714	1	
	16QAM	22.97	0.198	4.55	0.565	1	

LTE Band	BW	Modulation	Conducted Peak Power (dBm)	Conducted Peak Power (W)	Antenna Gain (dBi)	Maximum EIRP (W)	Maximum EIRP Limit (W)
13	5M	QPSK	24.27	0.267	1.58	0.234	3
		16QAM	23.30	0.214	1.58	0.187	3
	10M	QPSK	24.16	0.261	1.58	0.229	3
		16QAM	23.09	0.204	1.58	0.179	3

4. Occupied Bandwidth

4.1. Test Secification

According to FCC Part 2.1049, 27.53

4.2. Test Setup

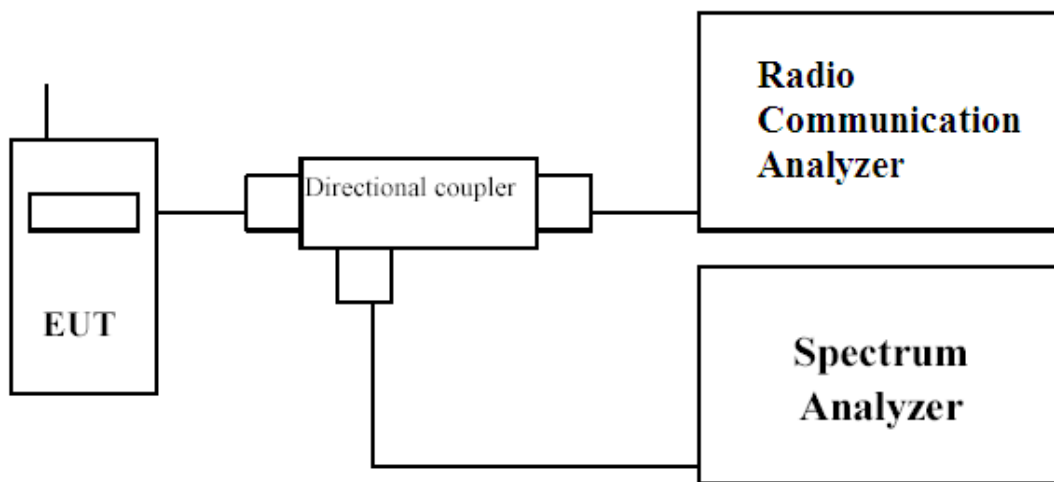

4.3. Test Procedure

The EUT is tested with maximum rated TX power via the Base Station simulator, and the occupied bandwidth was measured at the antenna terminals of the EUT. The Resolution BW of the analyzer is set to 1 %~5% of the emission bandwidth. The EUT's occupied bandwidth is measured as the width of the signal between two points, one below the carrier center frequency and one above the carrier frequency, outside of which all emissions are attenuated at least 26 dB below the transmitter power.

The plots below show the resultant display from the Spectrum Analyser.

4.4. Test Result of Occupied Bandwidth

Product	5G Extender Gen 2
Test Mode	Occupied Bandwidth
Test Site	CTR

LTE Band 4								
BW	Channel	Frequency (MHz)	99% Occupied Bandwidth (MHz)			26 dB bandwidth (MHz)		
			QPSK	16QAM	64QAM	QPSK	16QAM	64QAM
1.4M	19957	1710.7	1.0956	1.0964	--	1.299	1.293	--
1.4M	20175	1732.5	1.0991	1.0998	--	1.308	1.305	--
1.4M	20393	1754.3	1.0959	1.1025	--	1.290	1.304	--
3M	19965	1711.5	2.7325	2.7411	--	3.054	3.049	--
3M	20175	1732.5	2.7404	2.7359	--	3.063	3.047	--
3M	20385	1753.5	2.7410	2.7464	--	3.046	3.065	--
5M	19975	1712.5	4.5160	4.4996	--	4.986	5.003	--
5M	20175	1732.5	4.5201	4.5016	--	5.014	5.022	--
5M	20375	1752.5	4.5020	4.5066	--	4.988	4.996	--
10M	20000	1715	9.0515	9.0389	--	10.10	10.13	--
10M	20175	1732.5	9.0594	9.0458	--	10.06	10.05	--
10M	20350	1750	9.0681	9.0477	--	9.996	10.10	--
15M	20025	1717.5	13.453	13.465	--	14.66	14.68	--
15M	20175	1732.5	13.481	13.484	--	14.71	14.72	--
15M	20325	1747.5	13.455	13.445	--	14.70	14.65	--
20M	20050	1720	18.477	18.468	--	20.52	20.48	--
20M	20175	1732.5	18.510	18.472	--	20.47	20.41	--
20M	20300	1745	18.448	18.432	--	20.43	20.46	--

LTE Band 13								
BW	Channel	Frequency (MHz)	99% Occupied Bandwidth (MHz)			26 dB bandwidth (MHz)		
			QPSK	16QAM	64QAM	QPSK	16QAM	64QAM
5M	23205	779.5	4.5036	4.4937	--	5.025	5.025	--
5M	23230	782	4.5076	4.5073	--	4.998	5.006	--
5M	23255	784.5	4.5125	4.5017	--	5.020	5.016	--
10M	--	--	--	--	--	--	--	--
10M	23230	782	9.0343	9.0335	--	10.07	10.05	--
10M	--	--	--	--	--	--	--	--

Product	5G Extender Gen 2		
Test Mode	Occupied Bandwidth		
Date of Test	2021/06/05	Test Site	CTR
Test Condition	Band 4 QPSK/16QAM		

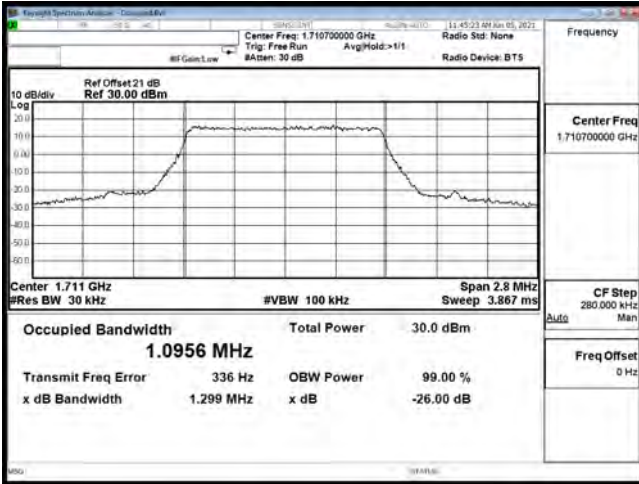

OCC B4 1.4M CH19957 QPSK

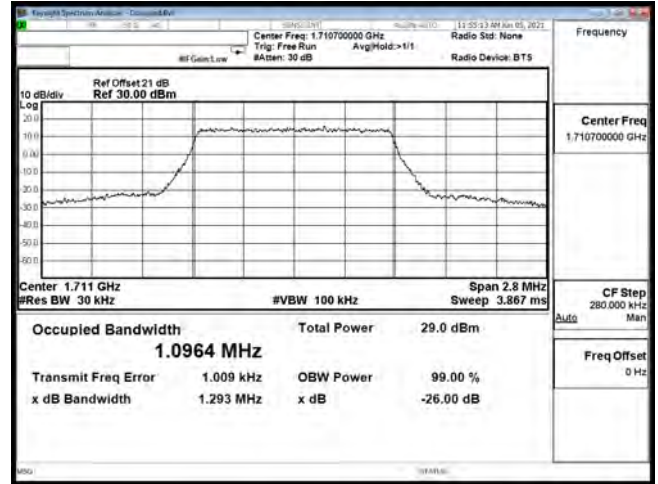

OCC B4 1.4M CH19957 16QAM

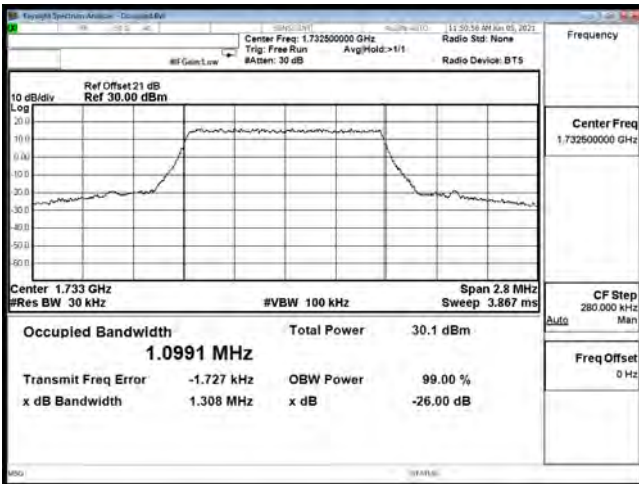

OCC B4 1.4M CH20175 QPSK

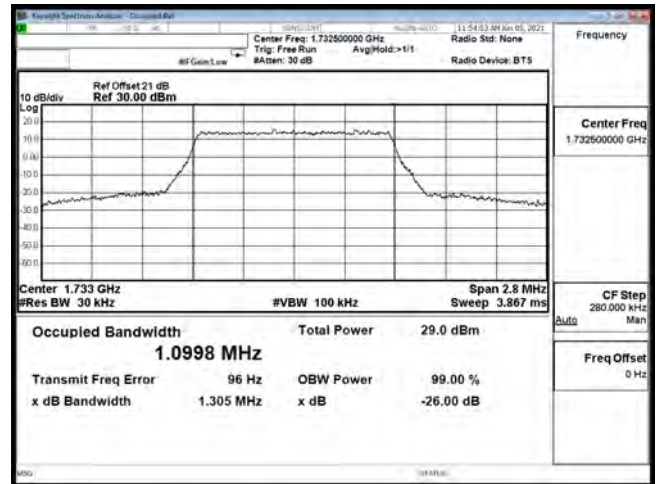

OCC B4 1.4M CH20175 16QAM

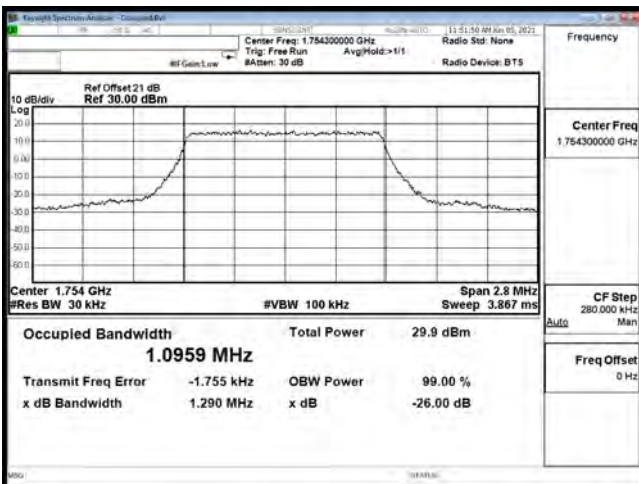

OCC B4 1.4M CH20393 QPSK

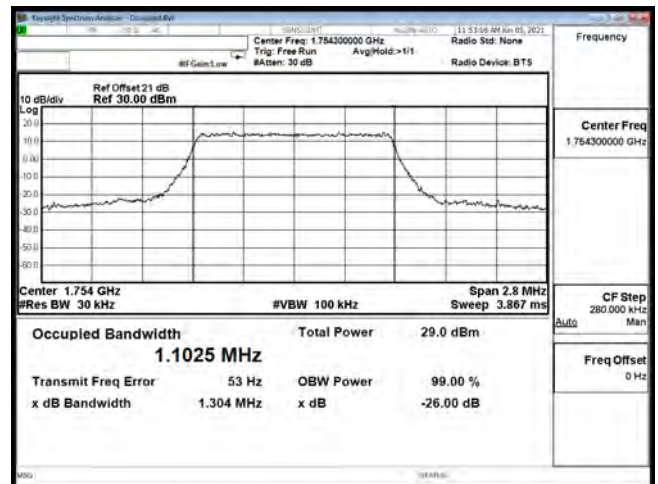

OCC B4 1.4M CH20393 16QAM

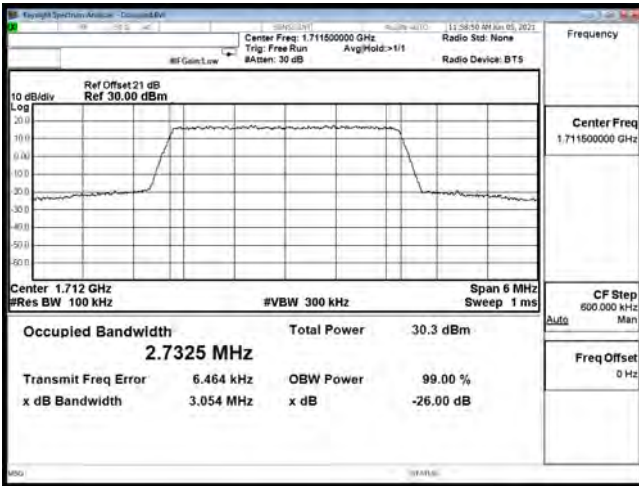

OCC B4 3M CH19965 QPSK

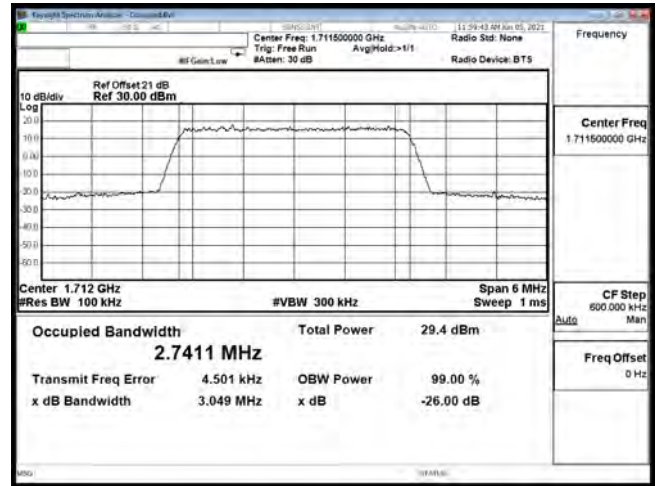

OCC B4 3M CH19965 16QAM

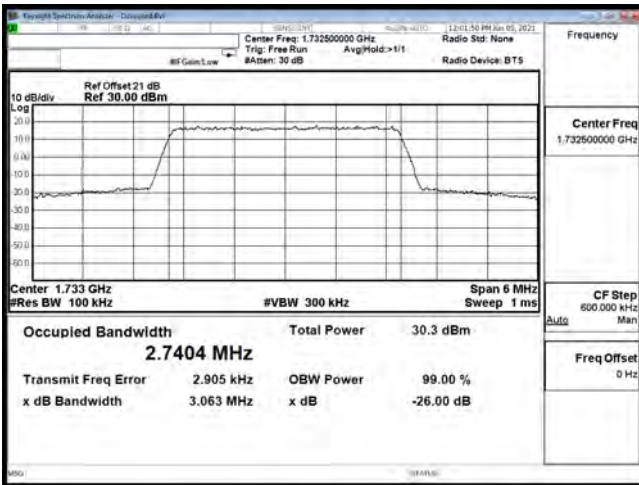

OCC B4 3M CH20175 QPSK

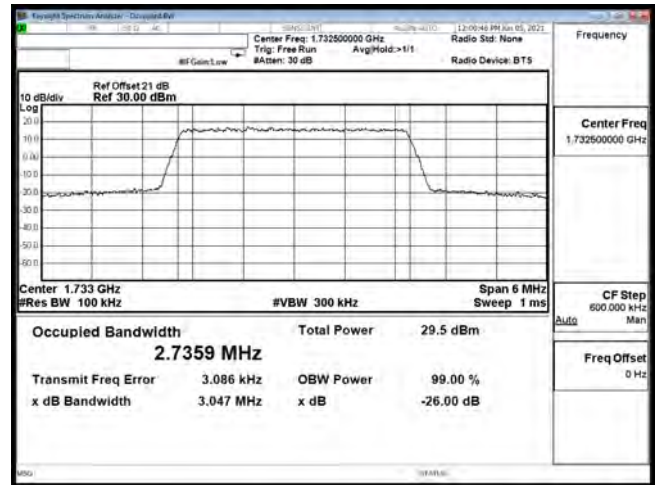

OCC B4 3M CH20175 16QAM

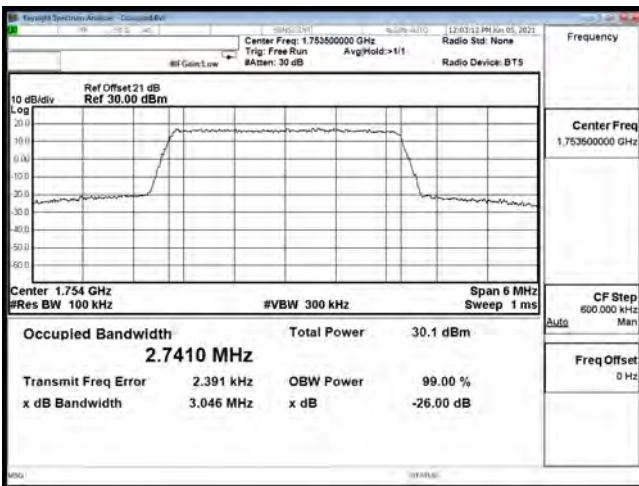

OCC B4 3M CH20385 QPSK

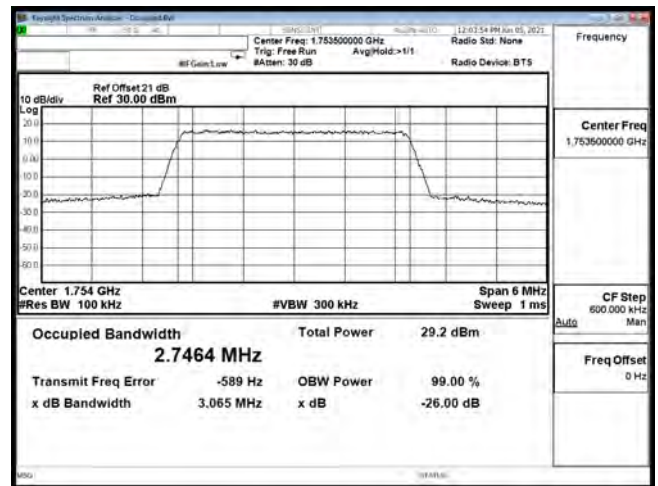

OCC B4 3M CH20385 16QAM

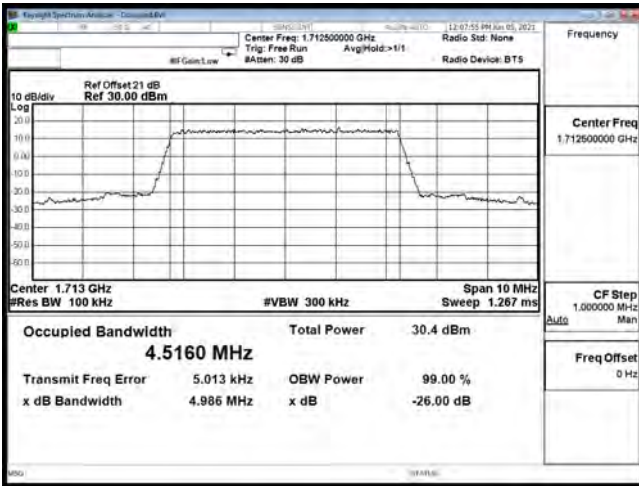

OCC B4 5M CH19975 QPSK

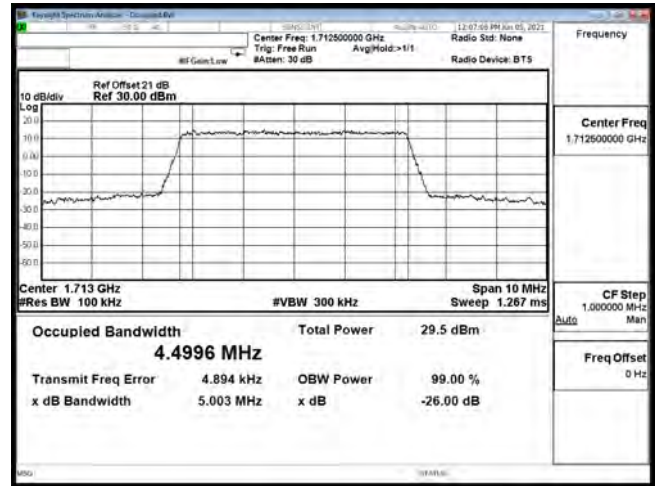

OCC B4 5M CH19975 16QAM

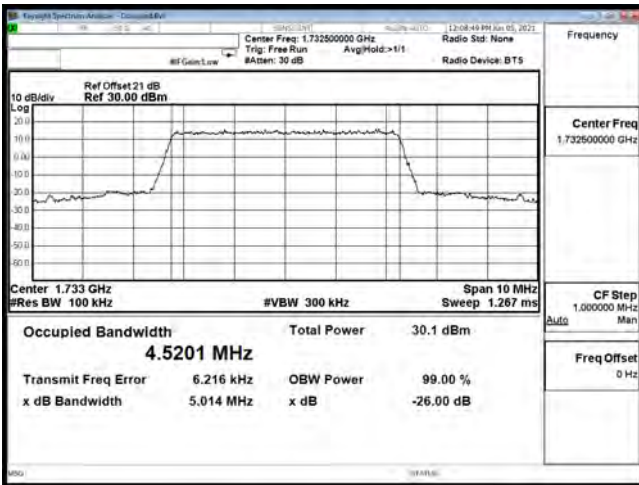

OCC B4 5M CH20175 QPSK

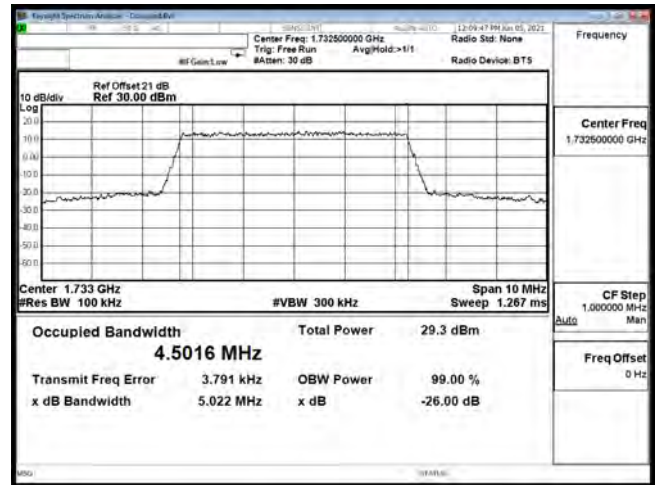

OCC B4 5M CH20175 16QAM

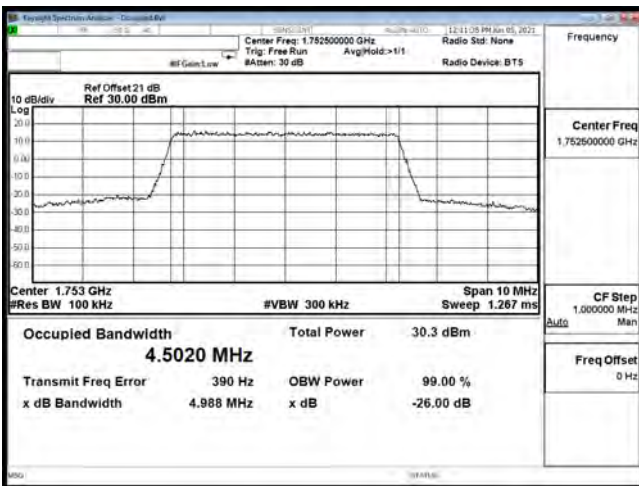

OCC B4 5M CH20375 QPSK

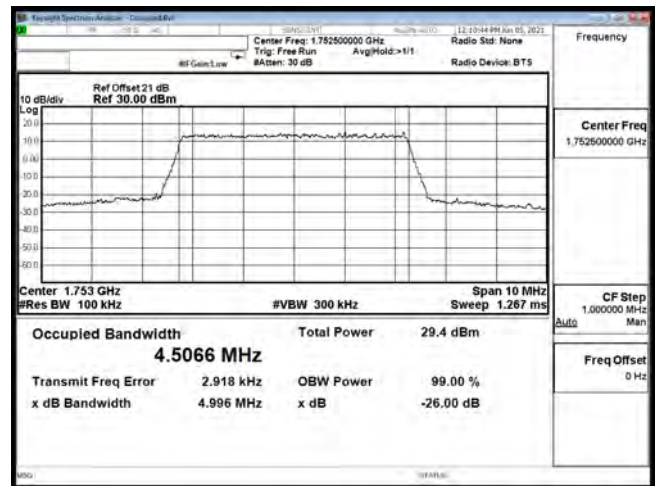

OCC B4 5M CH20375 16QAM

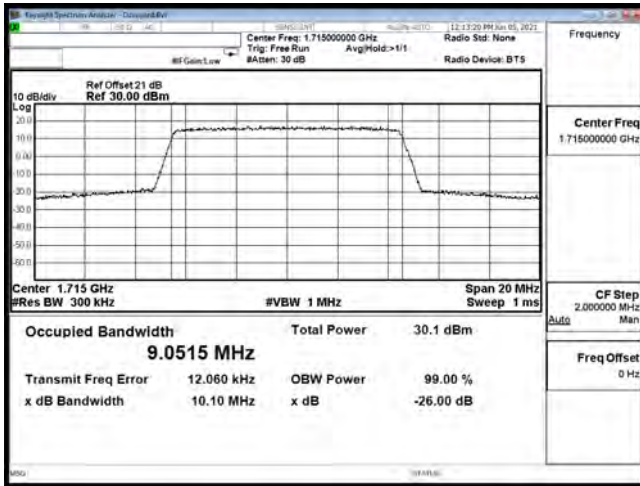

OCC B4 10M CH20000 QPSK

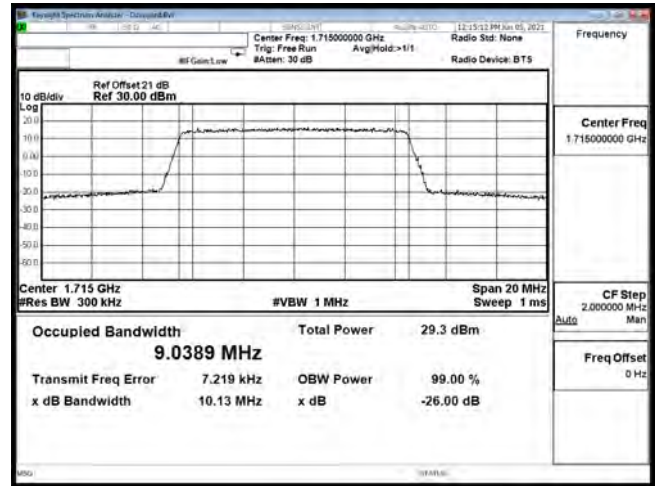

OCC B4 10M CH20000 16QAM

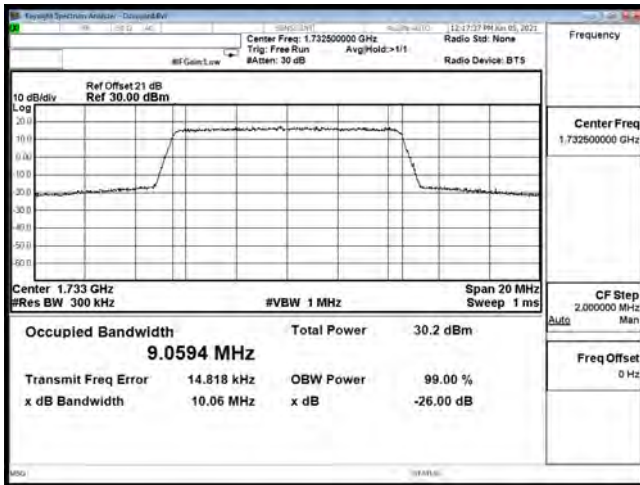

OCC B4 10M CH20175 QPSK

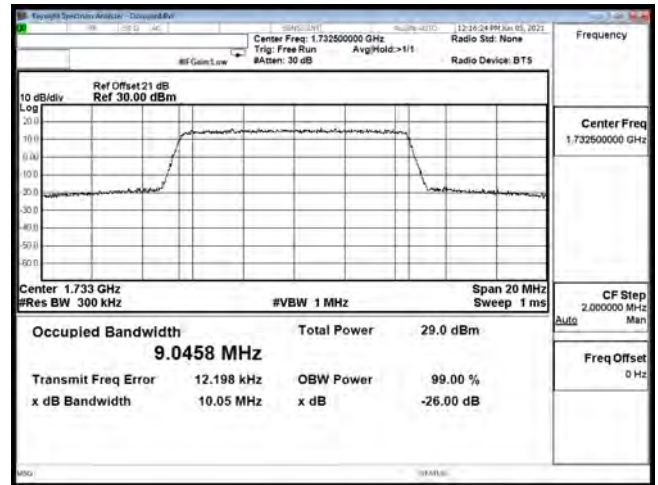

OCC B4 10M CH20175 16QAM

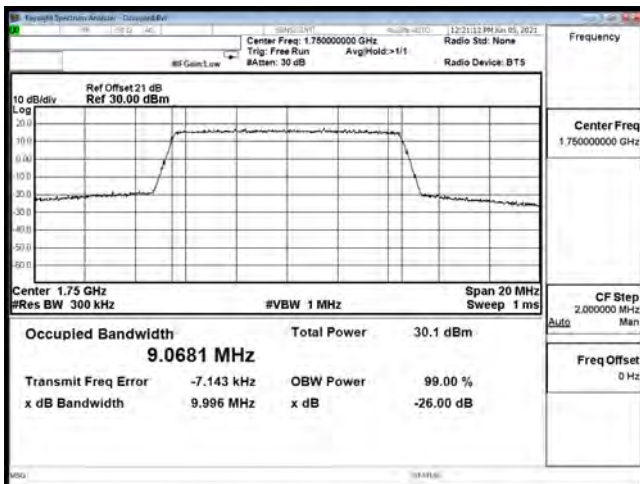

OCC B4 10M CH20350 QPSK

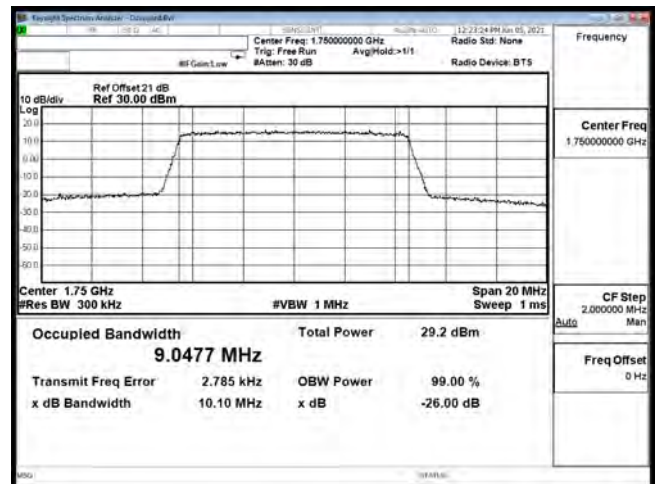

OCC B4 10M CH20350 16QAM

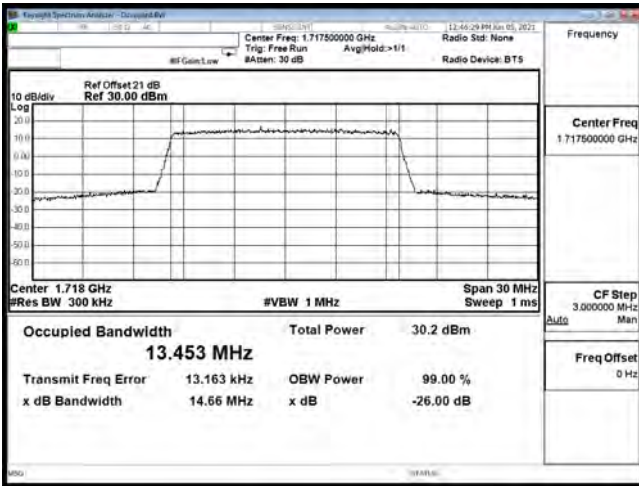

OCC B4 15M CH20025 QPSK

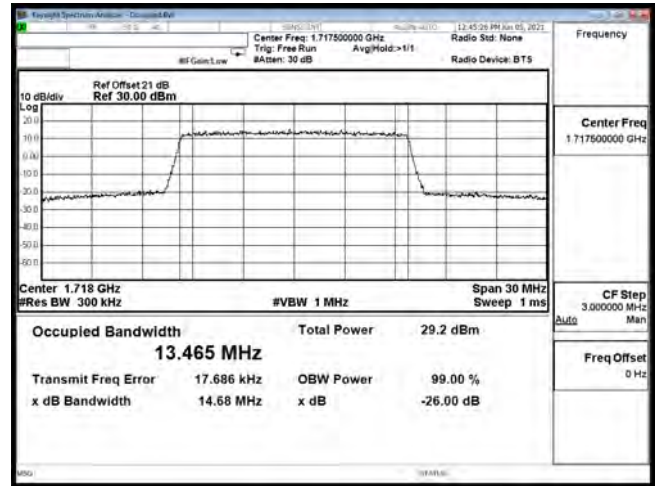

OCC B4 15M CH20025 16QAM

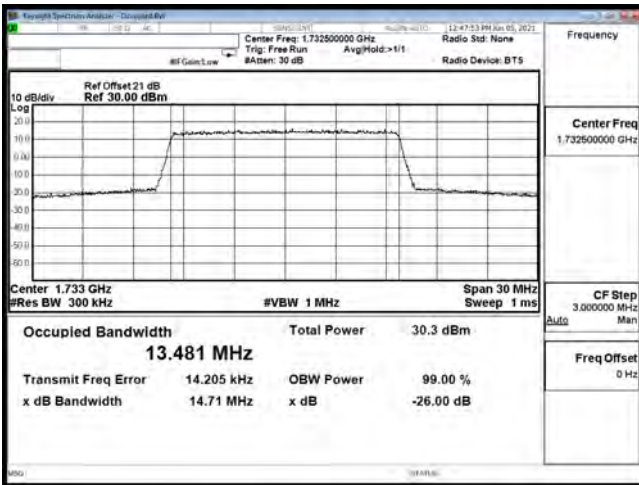

OCC B4 15M CH20175 QPSK

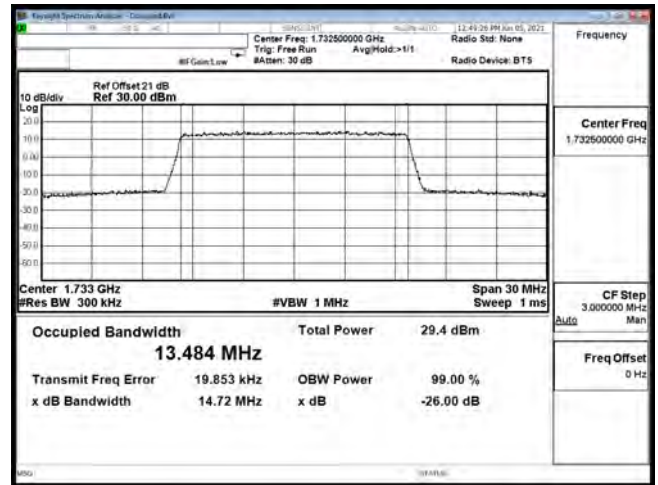

OCC B4 15M CH20175 16QAM

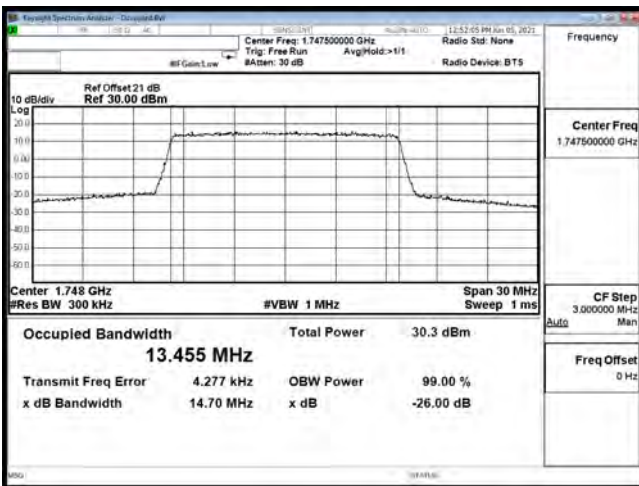

OCC B4 15M CH20325 PQSK

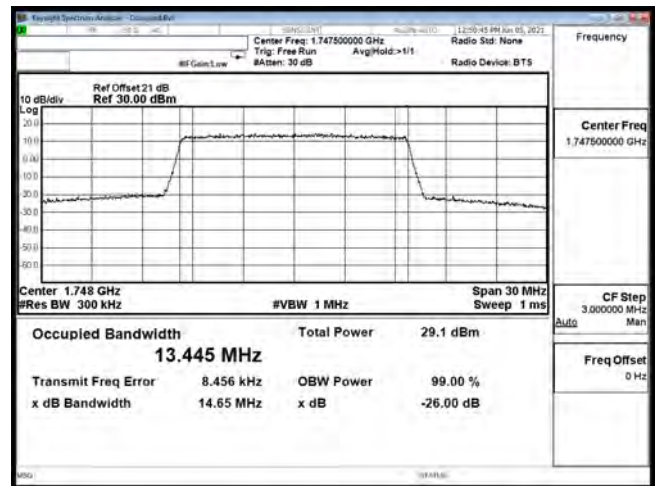

OCC B4 15M CH20325 16QAM

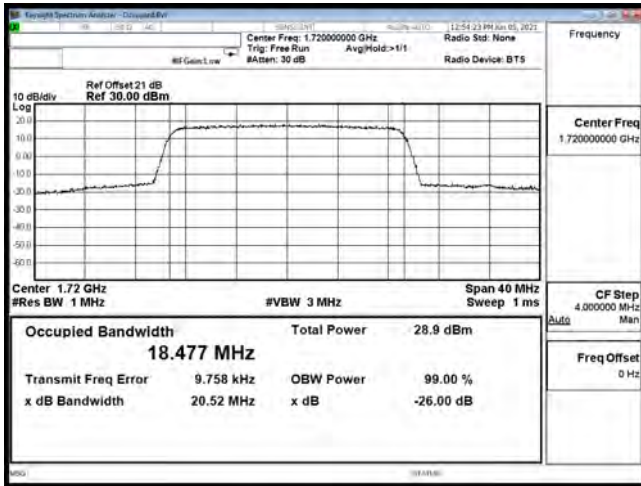

OCC B4 20M CH20050 QPSK

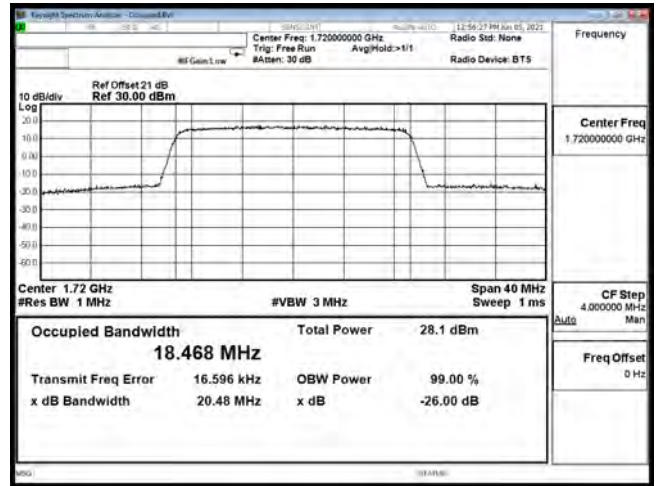

OCC B4 20M CH20050 16QAM

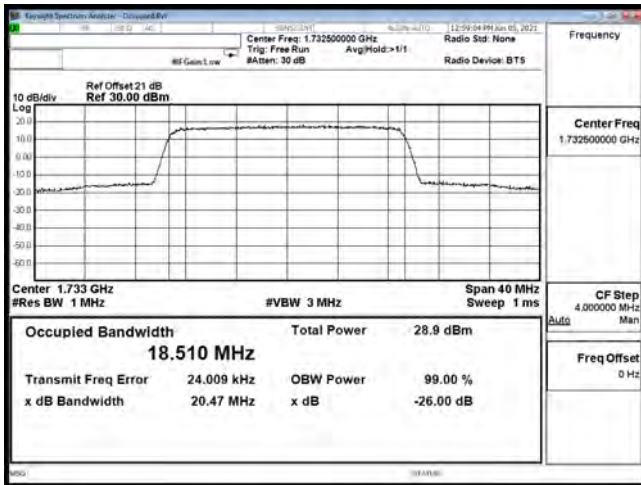

OCC B4 20M CH20175 QPSK

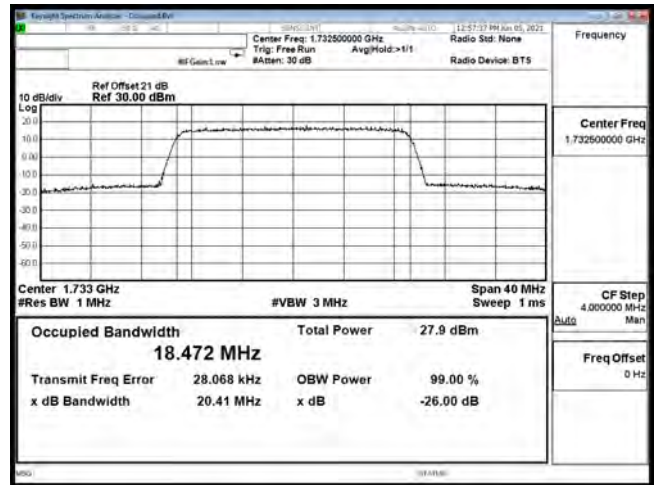

OCC B4 20M CH20175 16QAM

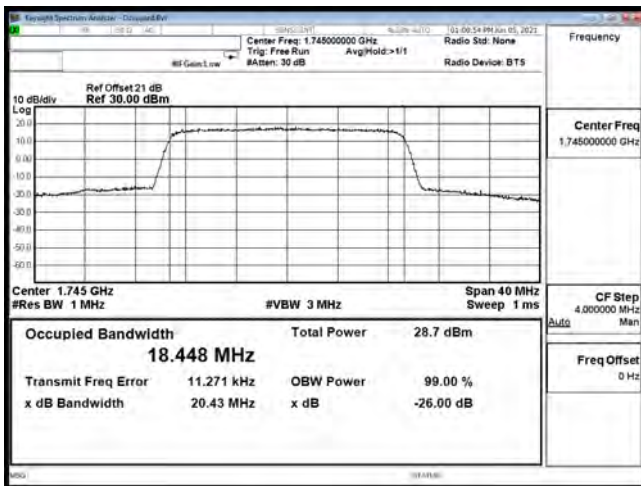

OCC B4 20M CH20300 QPSK

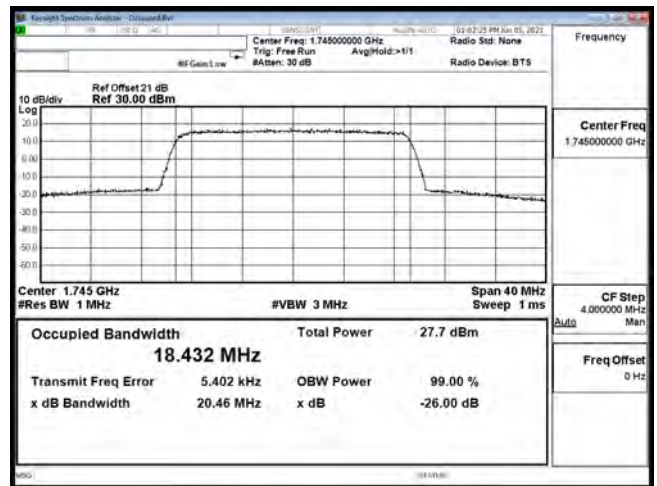

OCC B4 20M CH20300 16QAM

Product	5G Extender Gen 2		
Test Mode	Occupied Bandwidth		
Date of Test	2021/06/08	Test Site	CTR
Test Condition	Band 13 QPSK/16QAM		

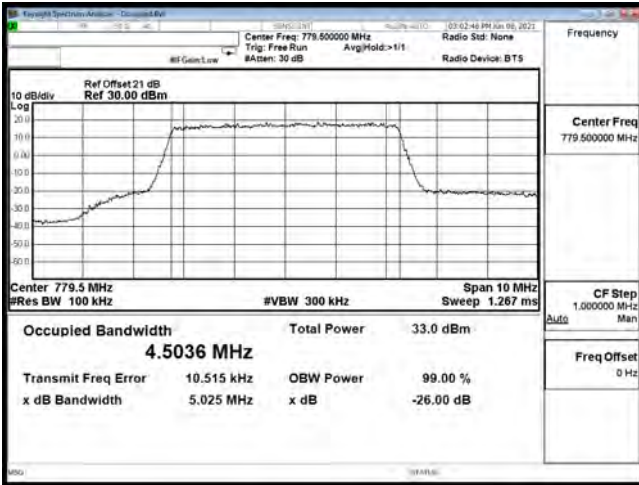

OCC B13 5M CH23205 QPSK

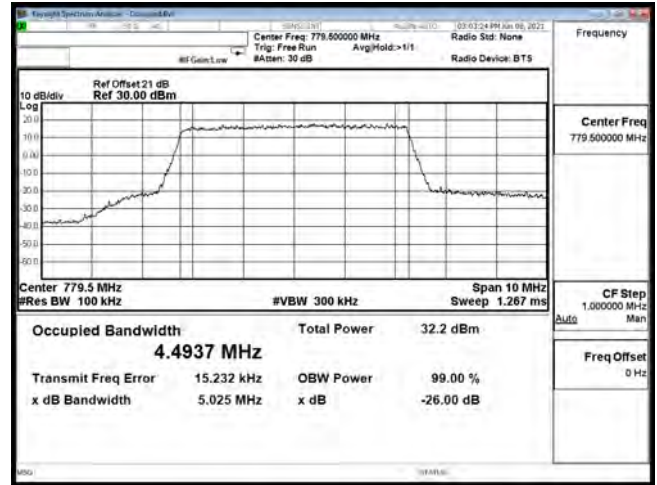

OCC B13 5M CH23205 16QAM

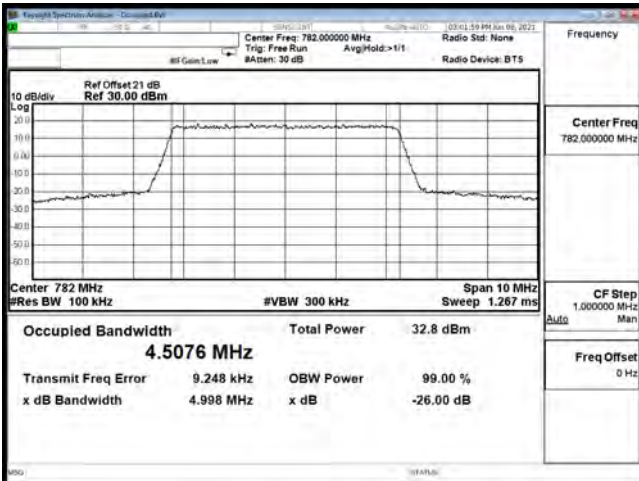

OCC B13 5M CH23230 QPSK

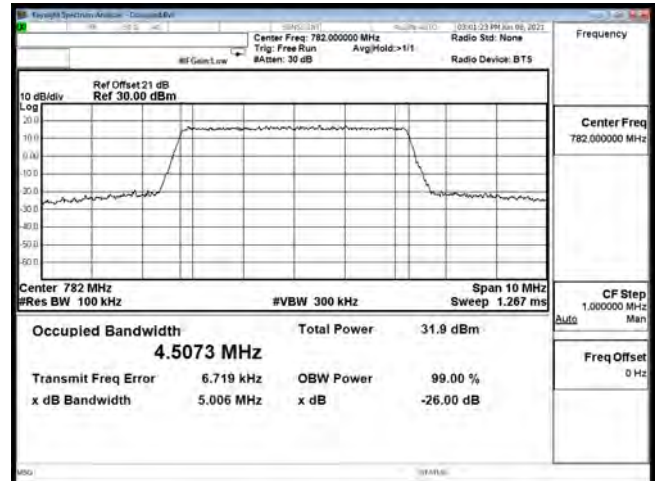

OCC B13 5M CH23230 16QAM

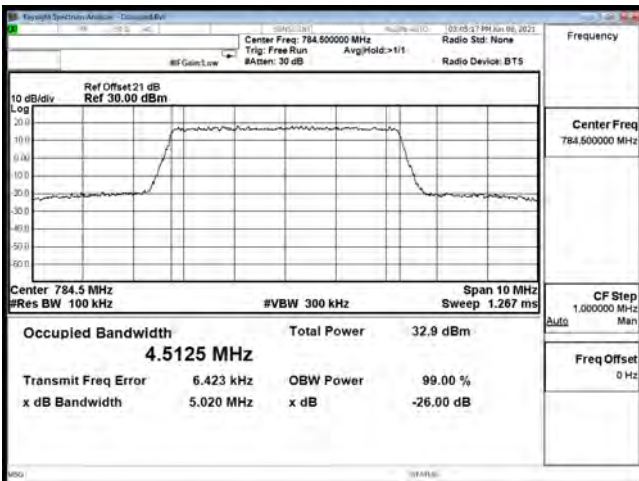

OCC B13 5M CH23255 QPSK

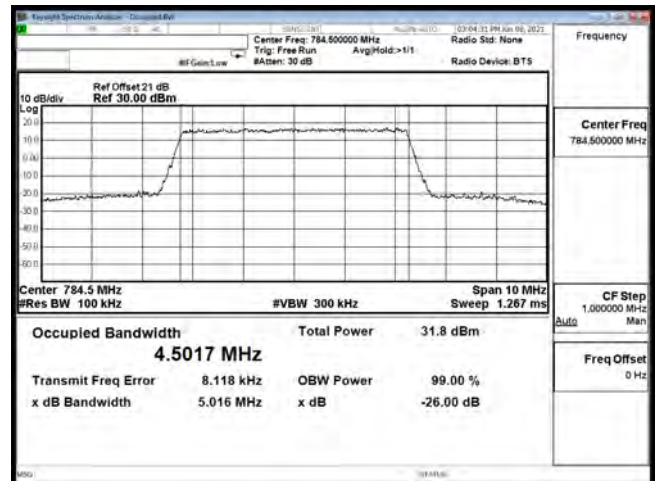

OCC B13 5M CH23255 16QAM

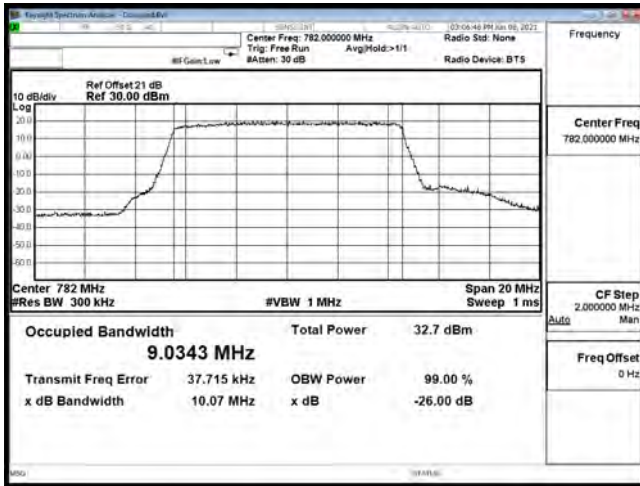

OCC B13 10M CH23230 QPSK

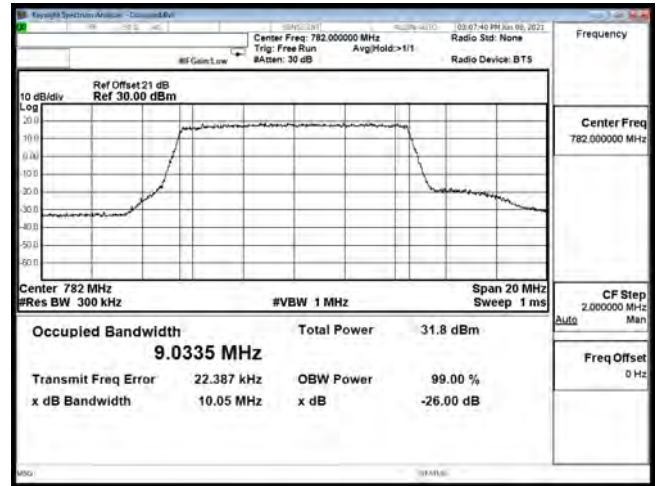

OCC B13 10M CH23230 16QAM

5. Spurious Emission At Antenna Terminals (+/-1MHz)

5.1. Test Specification

According to Part 2.1051, 27.53

5.2. Setup

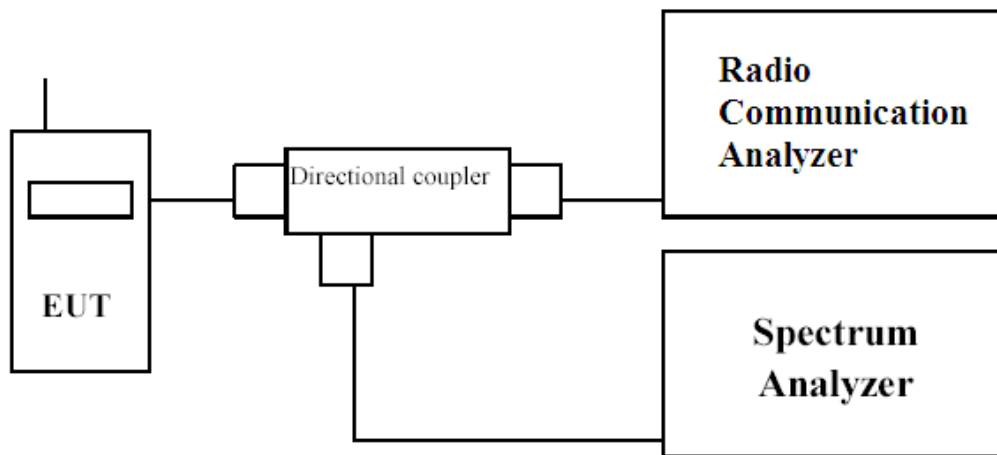

5.3. Limits

The spurious (unwanted) emission limits specified in the individual FCC rule parts applicable to licensed digital transmitters (typically referred to under the heading 'emission limits') normally apply to any and all emissions that are present outside of the authorized frequency band/block and apply to emissions in both the out-of-band and spurious domains. unwanted emissions are required by the licensed rule parts to be attenuated below the transmitter power by a factor of at least $43 + 10\log(P)$ dB, where P represents the transmitter power expressed in watts

For LTE Band 13 27.53(c):

For operations in the 746-758 MHz band and the 776-788 MHz band, the power of any emission outside the licensee's frequency band(s) of operation shall be attenuated below the transmitter power (P) within the licensed band(s) of operation, measured in watts, in accordance with the following:

- (1) On any frequency outside the 746-758 MHz band, the power of any emission shall be attenuated outside the band below the transmitter power (P) by at least $43 + 10 \log (P)$ dB;
- (2) On any frequency outside the 776-788 MHz band, the power of any emission shall be attenuated outside the band below the transmitter power (P) by at least $43 + 10 \log (P)$ dB;
- (3) On all frequencies between 763-775 MHz and 793-805 MHz, by a factor not less than $76 + 10 \log (P)$ dB in a 6.25 kHz band segment, for base and fixed stations;
- (4) On all frequencies between 763-775 MHz and 793-805 MHz, by a factor not less than $65 + 10 \log (P)$ dB in a 6.25 kHz band segment, for mobile and portable stations;

5.4. Test Procedure

In accordance with Part 27.53 at least 1% of the emission bandwidth was used for the resolution and video bandwidths up to 1MHz away from the Block Edge. At greater than 1MHz, the resolution and video bandwidth were increased to 1MHz/3MHz.

The reference power and path losses of all channels used for testing in each frequency block were measured.

5.5. Test Result of Spurious Emission At Antenna Terminals (+/-1MHz)

Product	5G Extender Gen 2		
Test Mode	Spurious Emission At Antenna Terminals (+/-1MHz)		
Date of Test	2021/06/04	Test Site	CTR
Test Condition	Block Edge Test (LTE Band 4)		

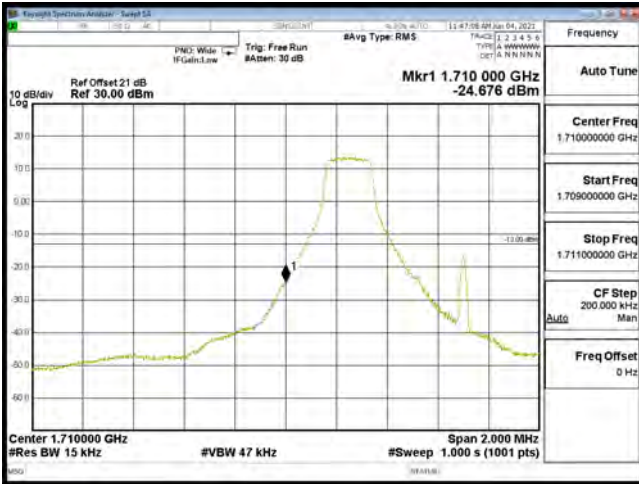

EDGE B4 1.4M CH19957 QPSK(1,0)

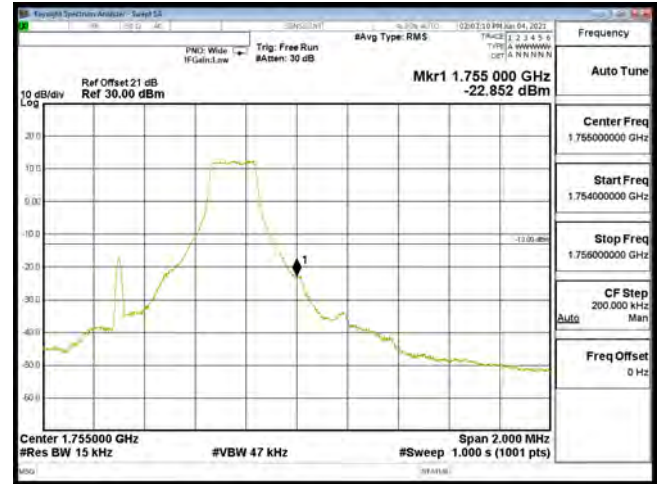

EDGE B4 1.4M CH20393 QPSK(1,5)

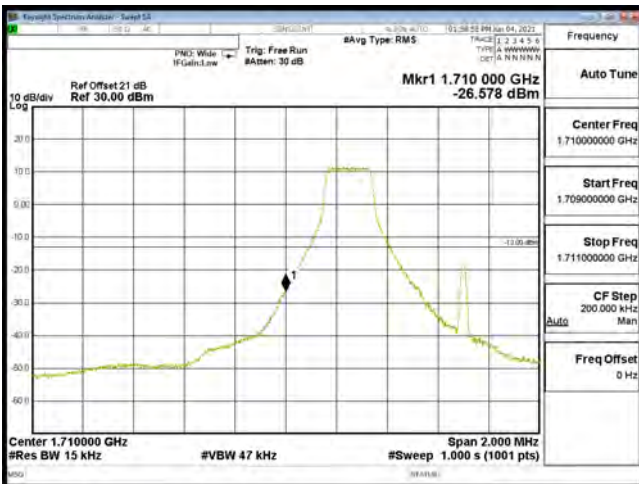

EDGE B4 1.4M CH19957 16QAM(1,0)

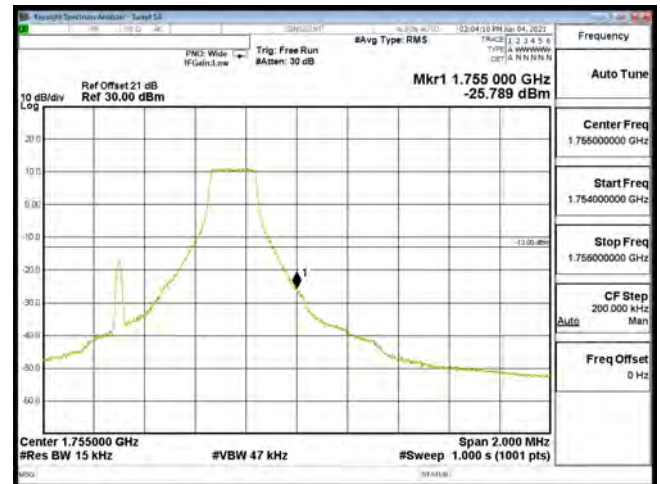

EDGE B4 1.4M CH20393 16QAM(1,5)



EDGE B4 1.4M CH19957 QPSK(6,0)

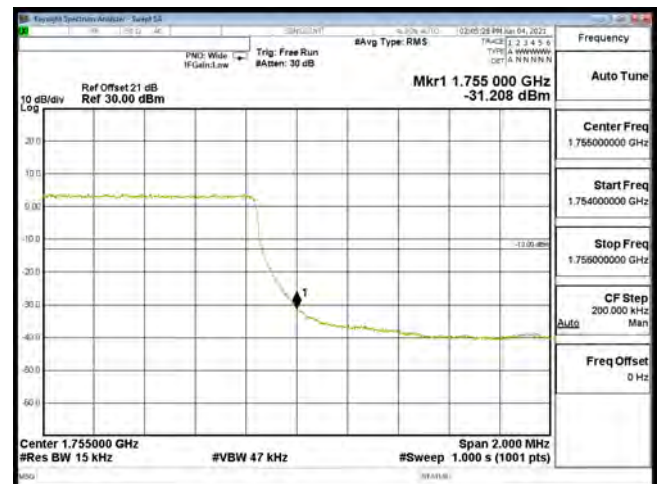

EDGE B4 1.4M CH20393 QPSK(6,0)



EDGE B4 1.4M CH19957 16QAM(6,0)

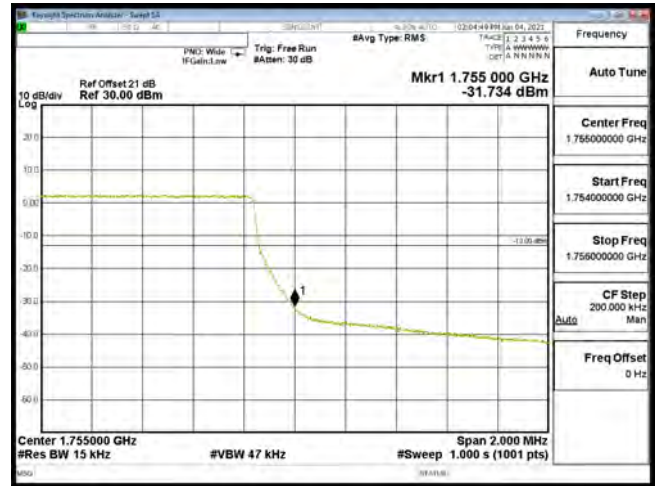

EDGE B4 1.4M CH20393 16QAM(6,0)

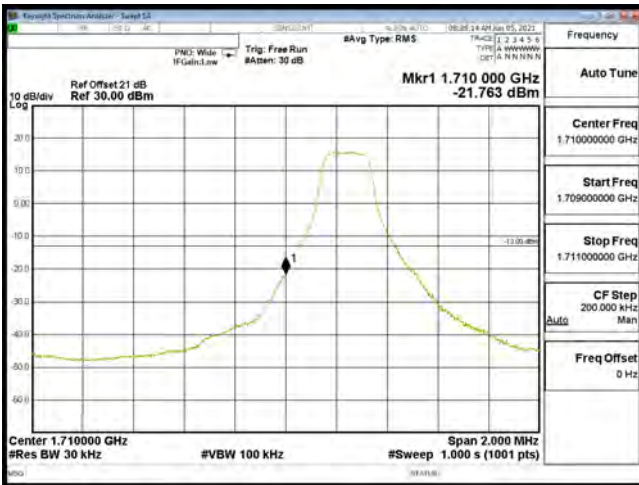

EDGE B4 3M CH19965 QPSK(1,0)

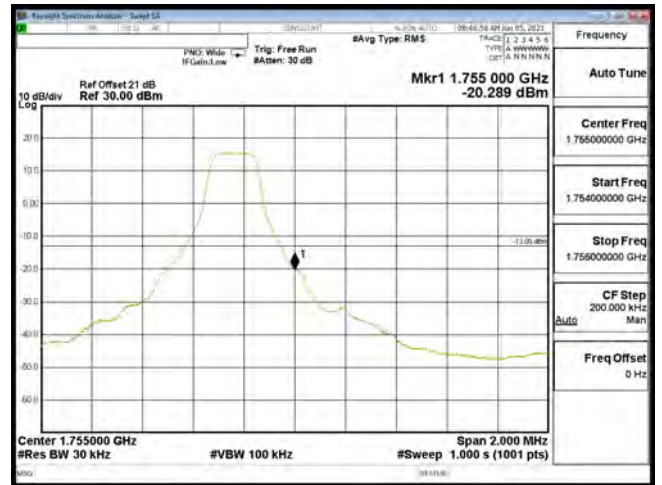

EDGE B4 3M CH20385 QPSK(1,14)

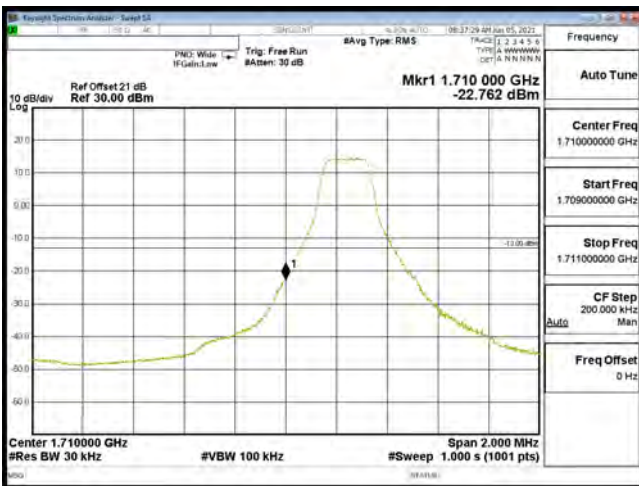

EDGE B4 3M CH19965 16QAM(1,0)

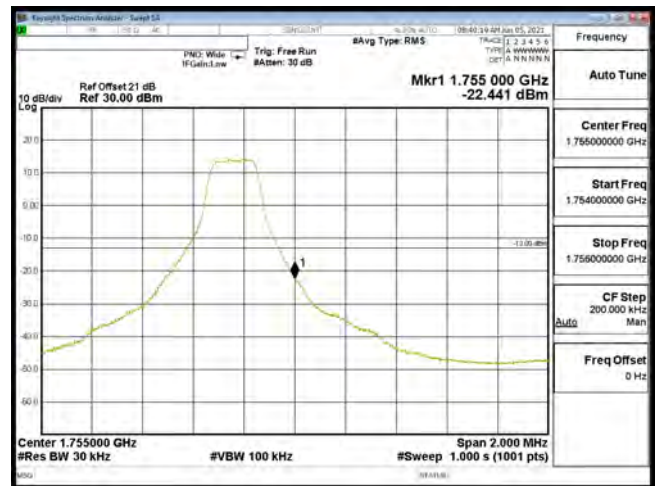

EDGE B4 3M CH20385 16QAM(1,14)

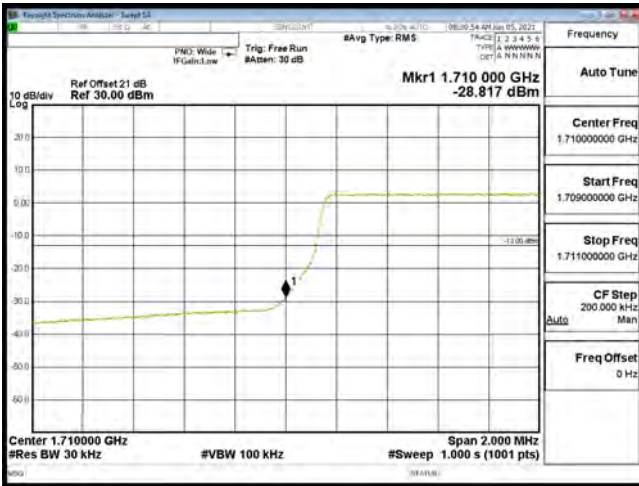

EDGE B4 3M CH19965 QPSK(15,0)

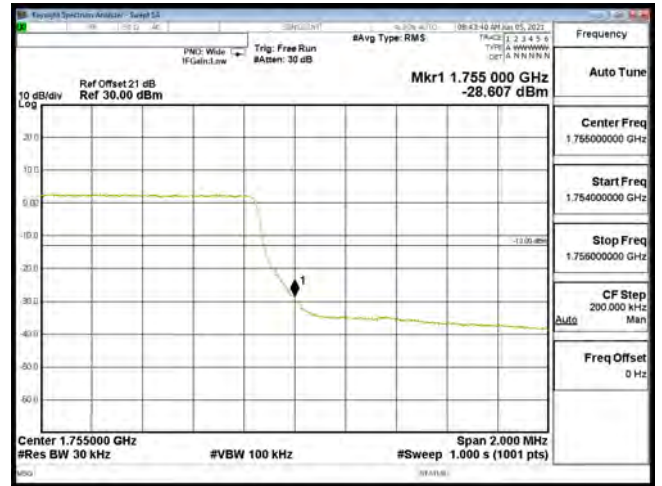

EDGE B4 3M CH20385 QPSK(15,0)

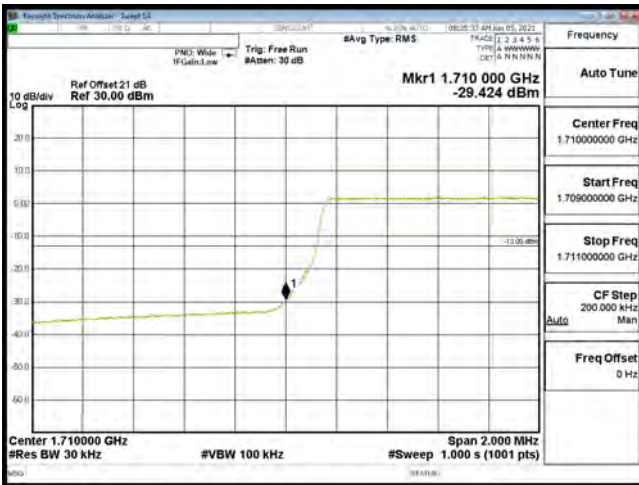

EDGE B4 3M CH19965 16QAM(15,0)

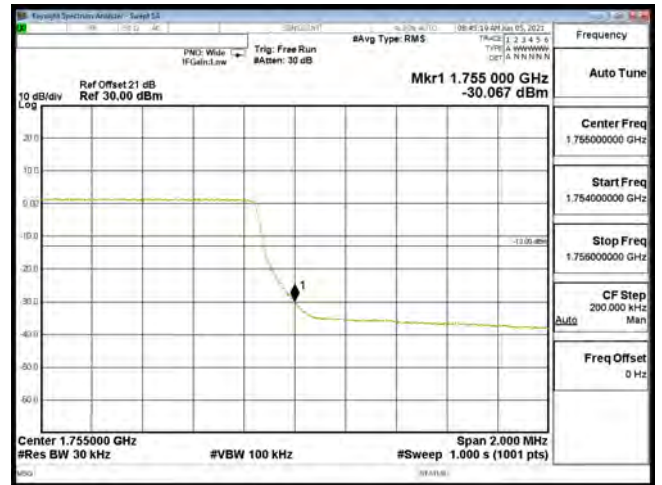

EDGE B4 3M CH20385 16QAM(15,0)

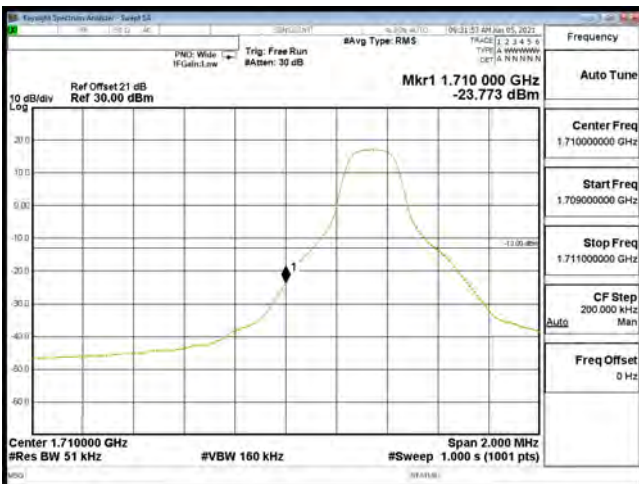

EDGE B4 5M CH19975 QPSK(1,0)



EDGE B4 5M CH20375 QPSK(1,24)

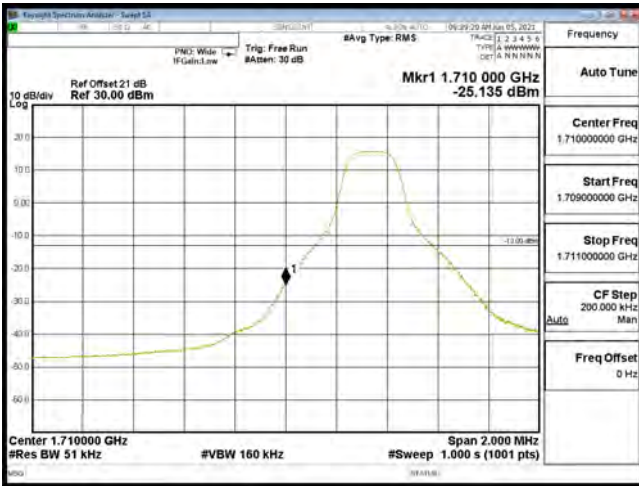

EDGE B4 5M CH19975 16QAM(1,0)



EDGE B4 5M CH20375 16QAM(1,24)

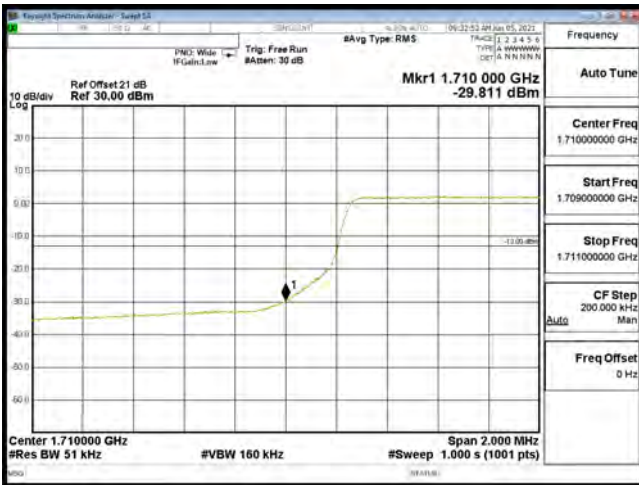

EDGE B4 5M CH19975 QPSK(25,0)

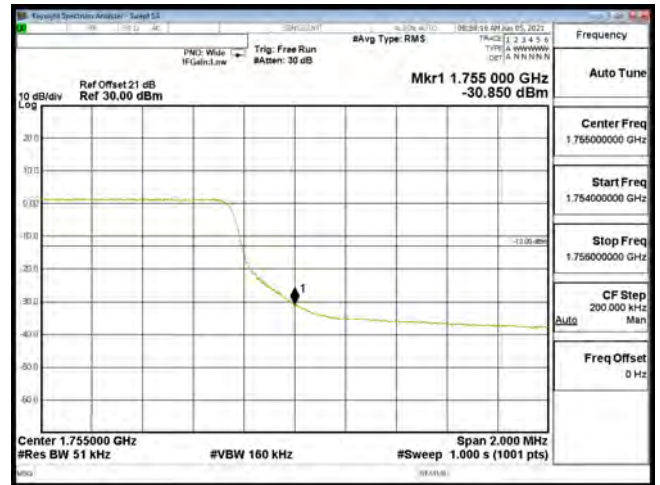

EDGE B4 5M CH20375 QPSK(25,0)

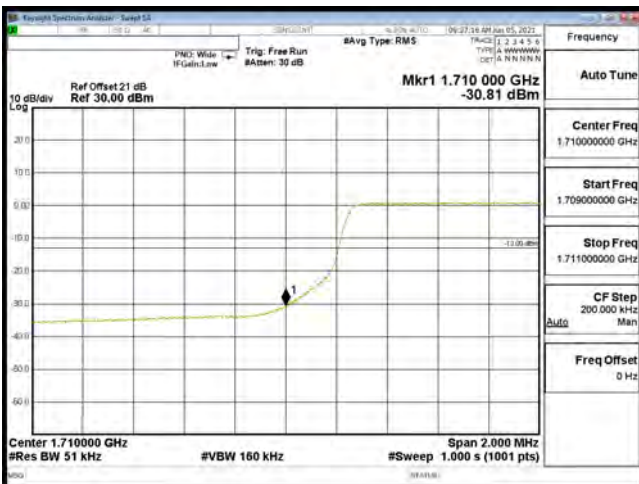

EDGE B4 5M CH19975 16QAM(25,0)

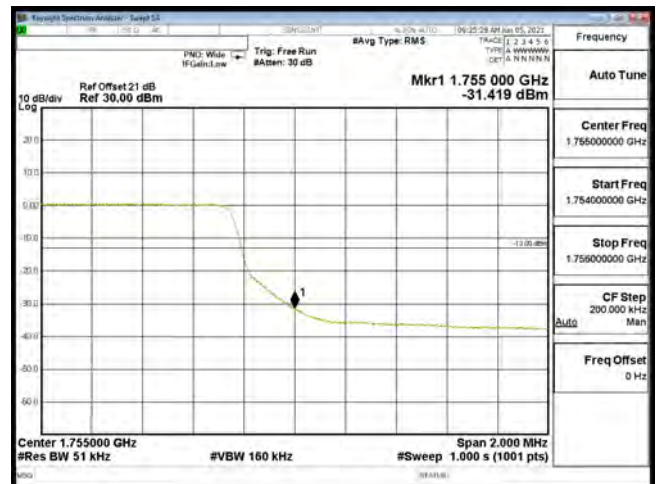

EDGE B4 5M CH20375 16QAM(25,0)

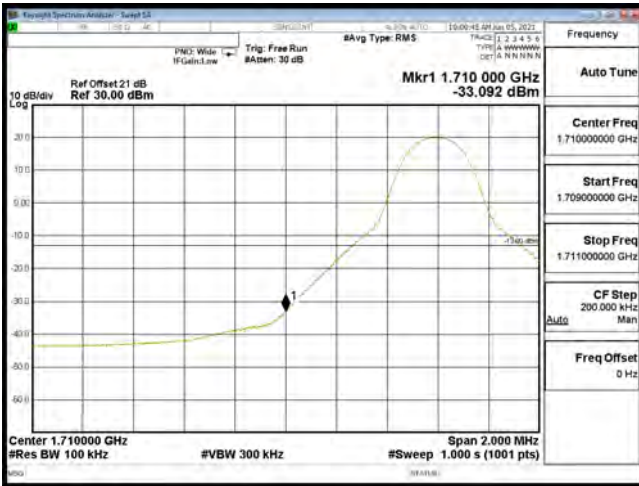

EDGE B4 10M CH20000 QPSK(1,0)



EDGE B4 10M CH20350 QPSK(1,49)

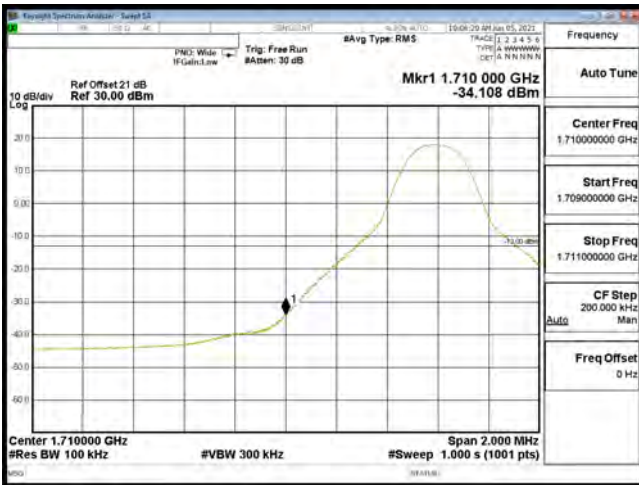

EDGE B4 10M CH20000 16QAM(1,0)

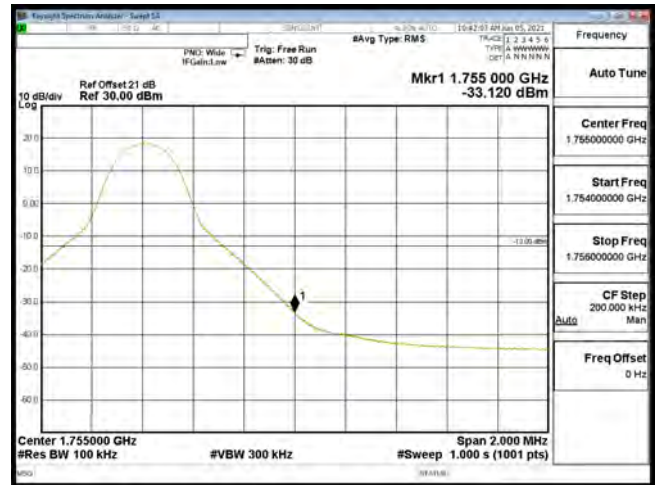

EDGE B4 10M CH20350 16QAM(1,49)

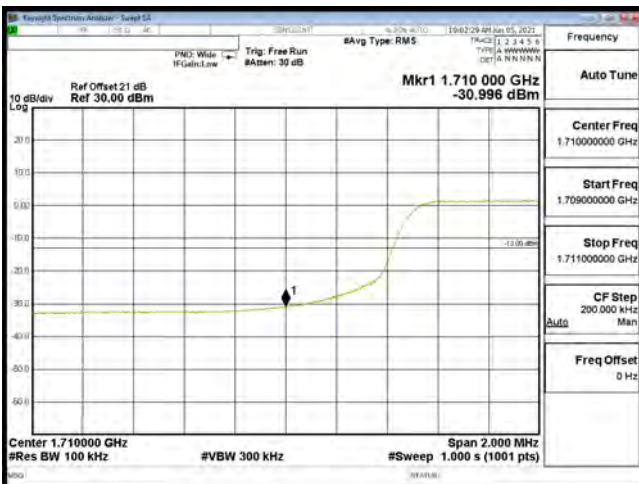

EDGE B4 10M CH20000 QPSK(50,0)

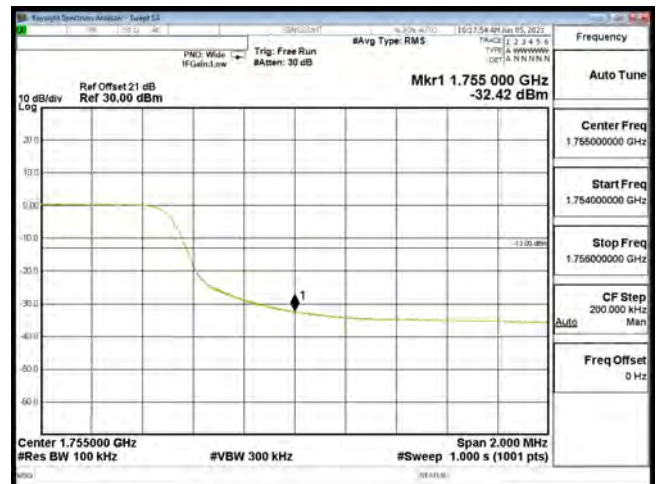

EDGE B4 10M CH20350 QPSK(50,0)

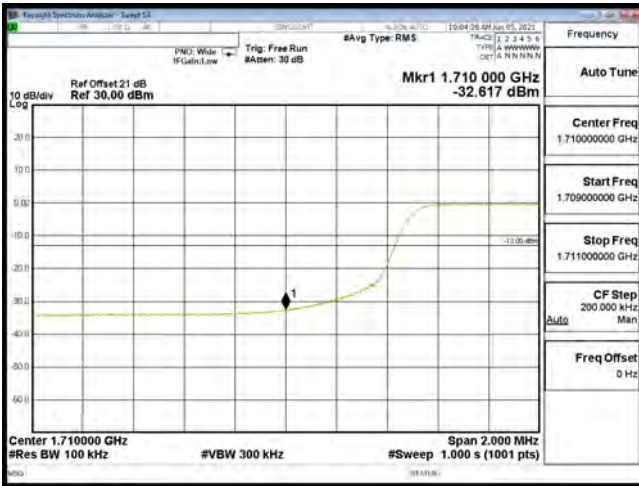

EDGE B4 10M CH20000 16QAM(50,0)

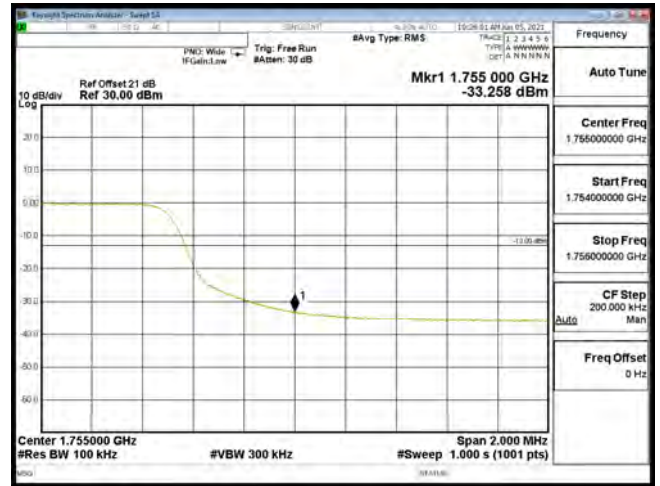

EDGE B4 10M CH20350 16QAM(50,0)



EDGE B4 15M CH20025 QPSK(1,0)



EDGE B4 15M CH20325 QPSK(1,74)



EDGE B4 15M CH20025 16QAM(1,0)

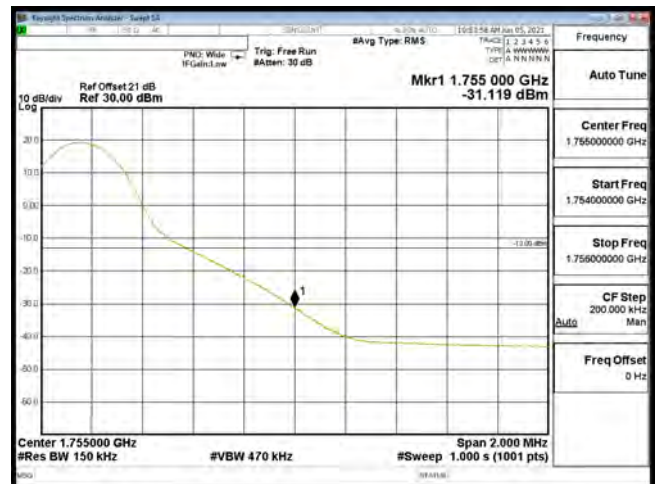

EDGE B4 15M CH20325 16QAM(1,74)

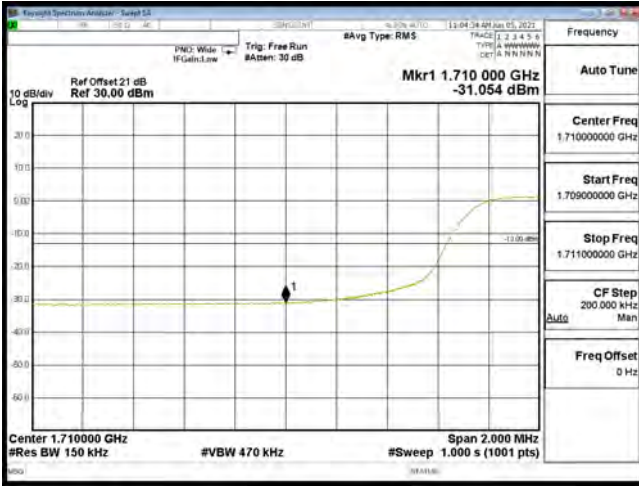

EDGE B4 15M CH20025 QPSK(75,0)

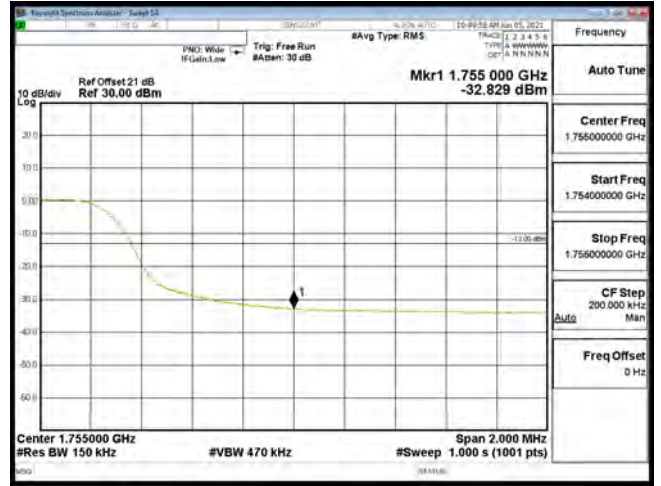

EDGE B4 15M CH20325 QPSK(75,0)

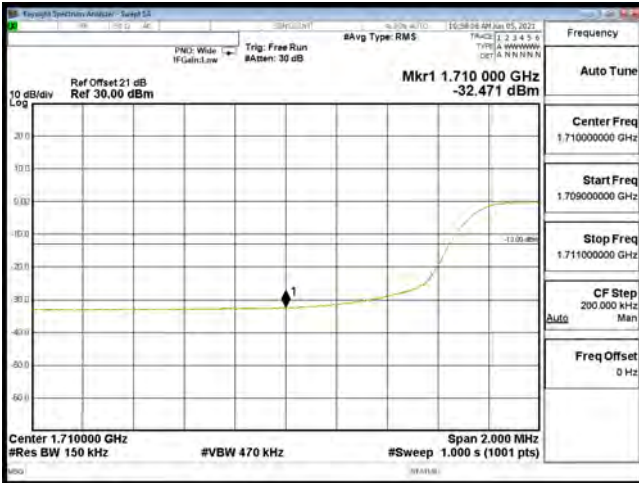

EDGE B4 15M CH20025 16QAM(75,0)

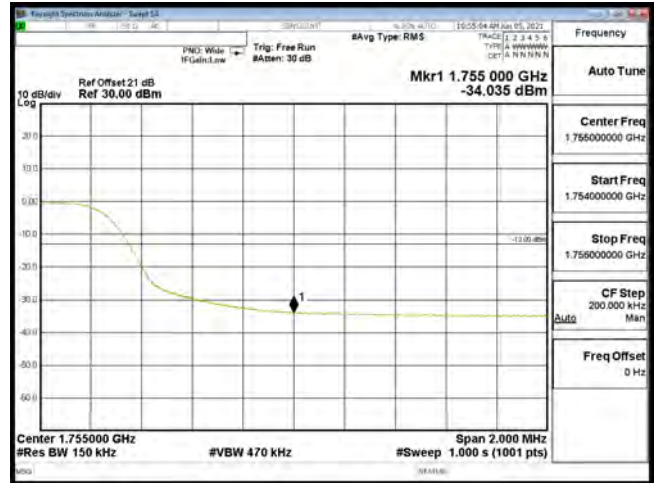

EDGE B4 15M CH20325 16QAM(75,0)

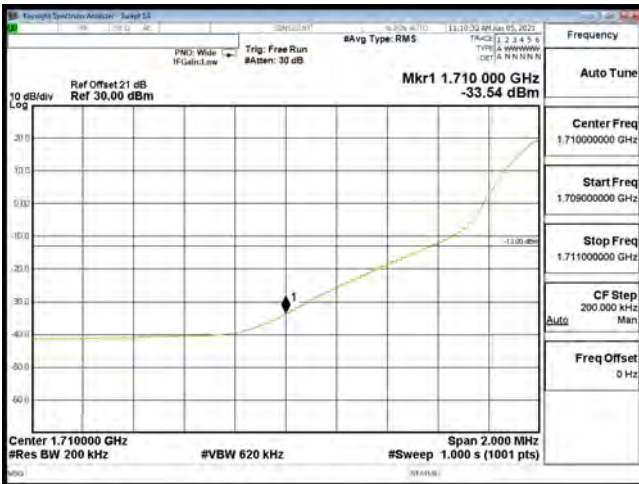

EDGE B4 20M CH20050 QPSK(1,0)

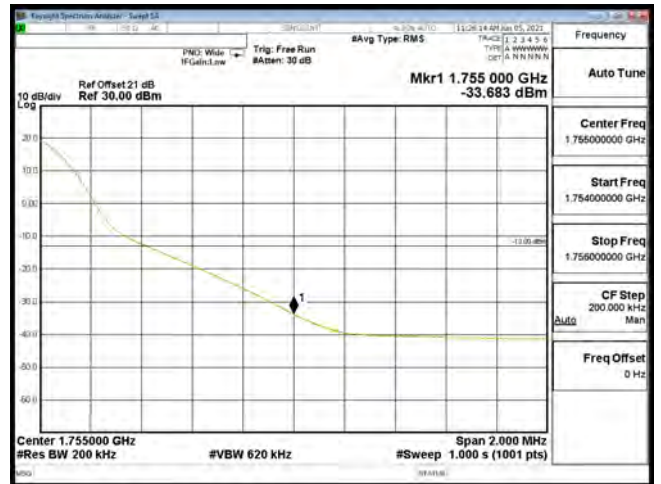

EDGE B4 20M CH20300 QPSK(1,99)

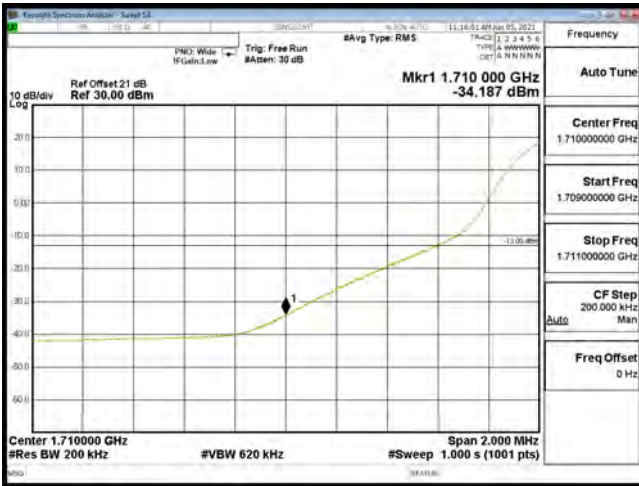

EDGE B4 20M CH20050 16QAM(1,0)

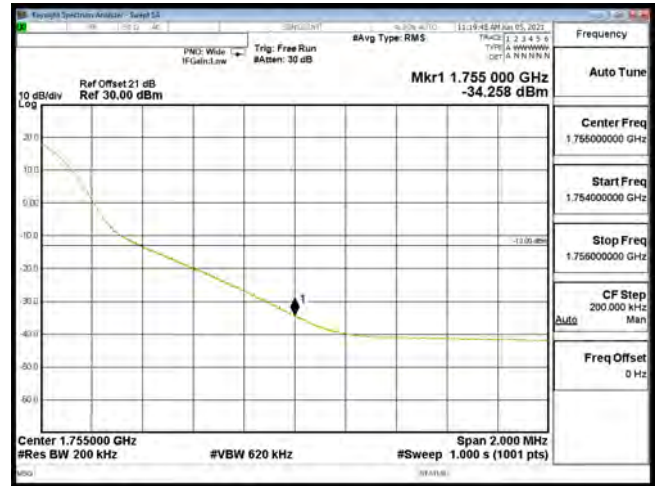

EDGE B4 20M CH20300 16QAM(1,99)

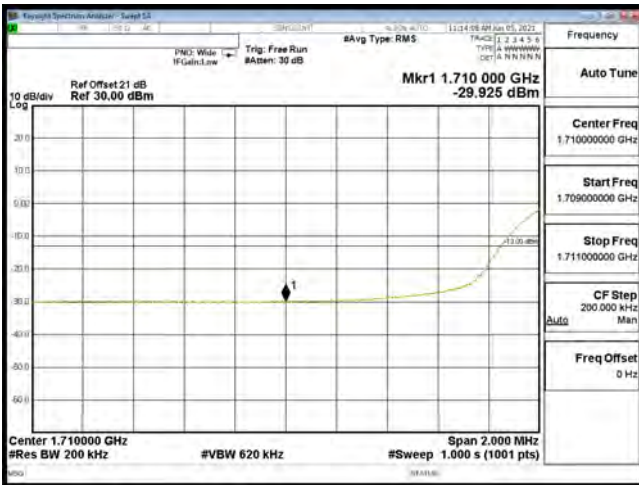

EDGE B4 20M CH20050 QPSK(100,0)

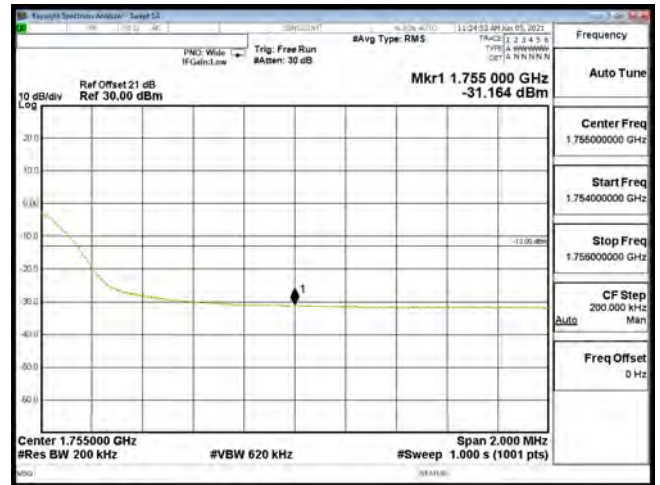

EDGE B4 20M CH20300 QPSK(100,0)

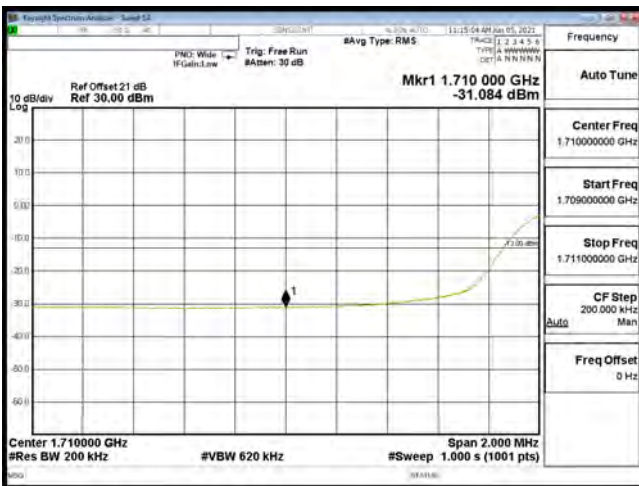

EDGE B4 20M CH20050 16QAM(100,0)

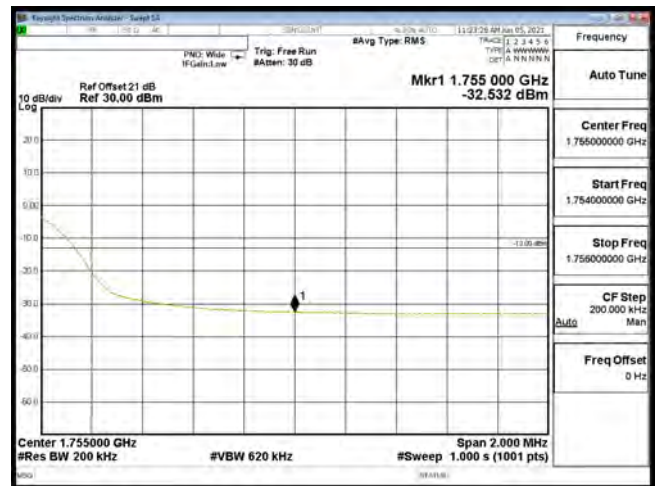

EDGE B4 20M CH20300 16QAM(100,0)

Product	5G Extender Gen 2		
Test Mode	Spurious Emission At Antenna Terminals (+/-1MHz)		
Date of Test	2021/06/08	Test Site	CTR
Test Condition	Block Edge Test (LTE Band 13)		

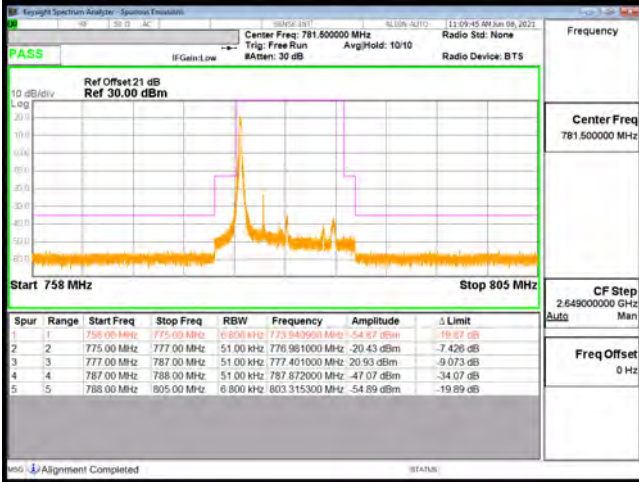

EDGE B13 5M CH23205 QPSK(1,0)

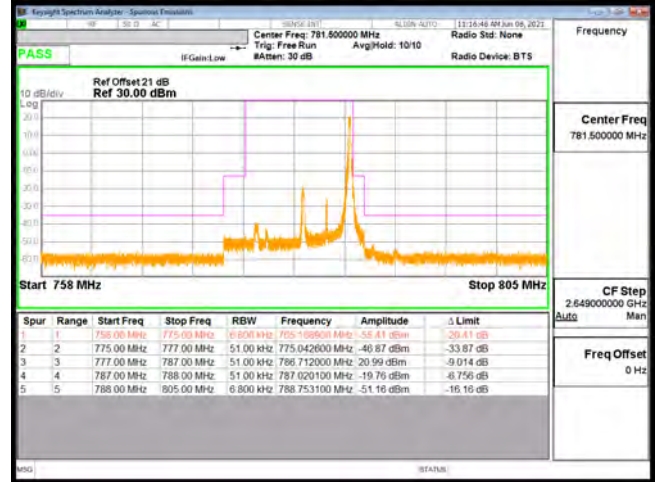

EDGE B13 5M CH23225 QPSK(1,24)



EDGE B13 5M CH23205 16QAM(1,0)

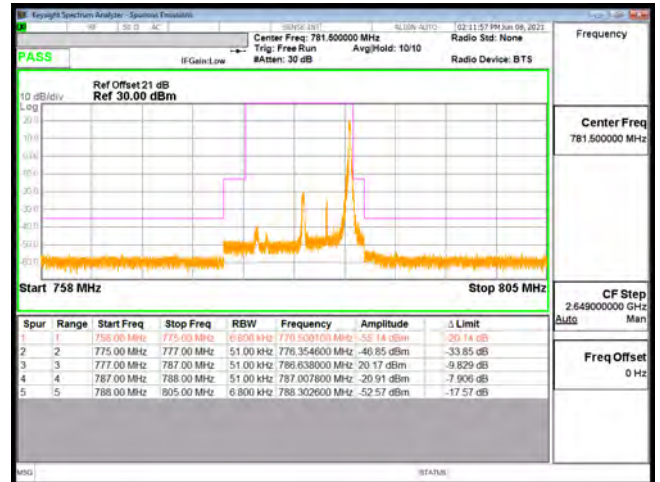

EDGE B13 5M CH23225 16QAM(1,24)



EDGE B13 5M CH23205 QPSK(25,0)



EDGE B13 5M CH23225 QPSK(25,0)

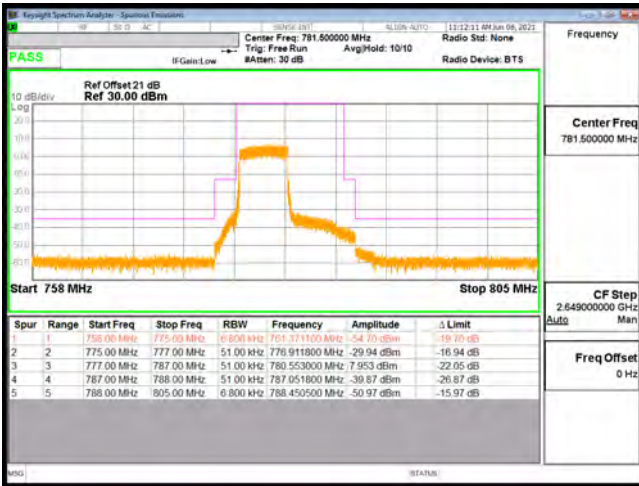

EDGE B13 5M CH23205 16QAM(25,0)

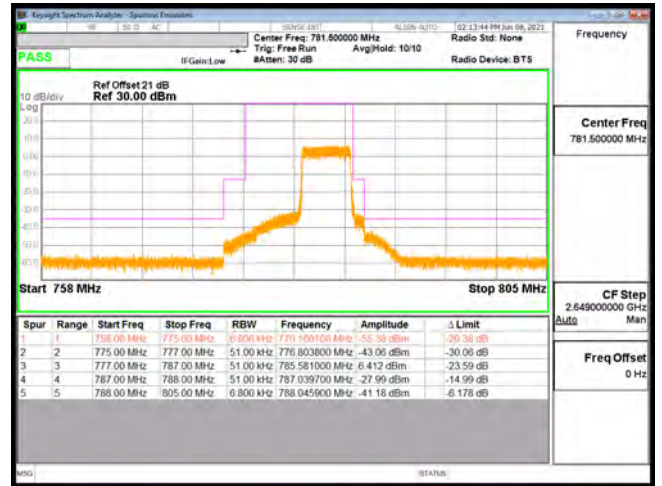

EDGE B13 5M CH23225 16QAM(25,0)

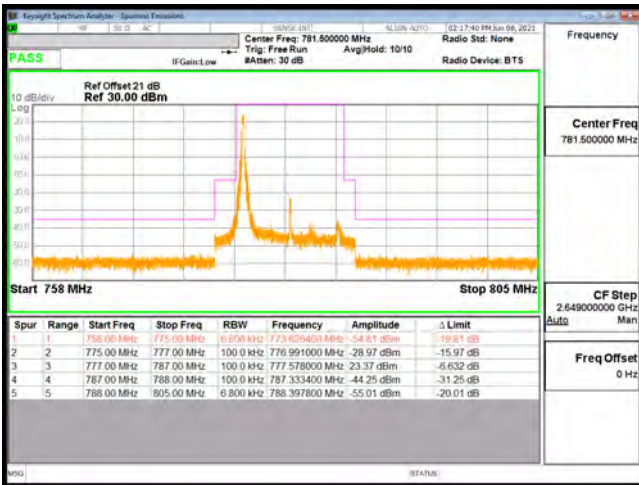

EDGE B13 10M CH23230 QPSK(1,0)

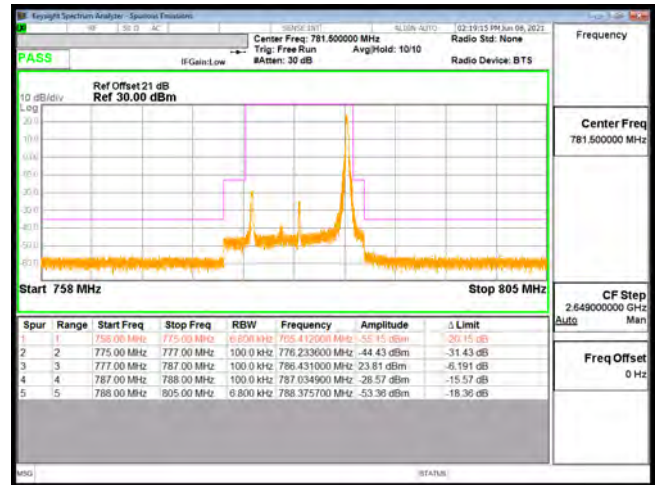

EDGE B13 10M CH23230 QPSK(1,49)

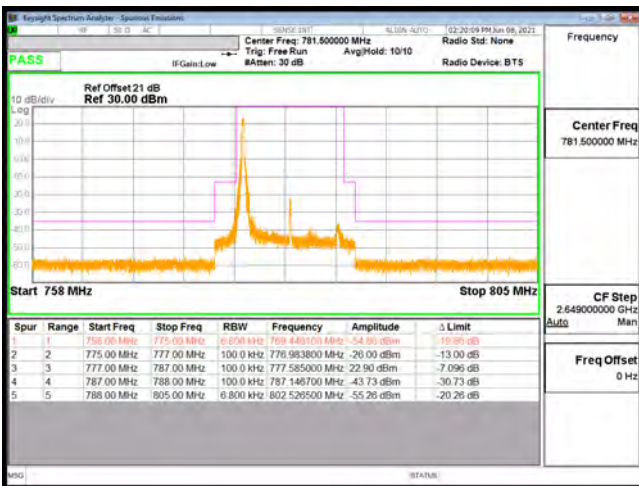

EDGE B13 10M CH23230 16QAM(1,0)

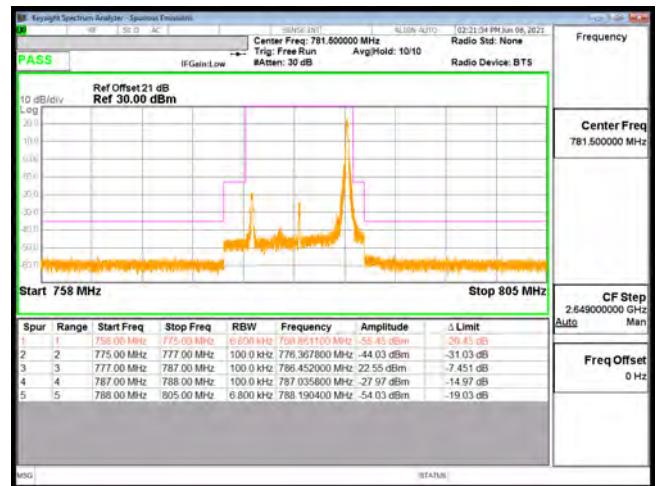

EDGE B13 10M CH23230 16QAM(1,49)



EDGE B13 10M CH23230 QPSK(50,0)

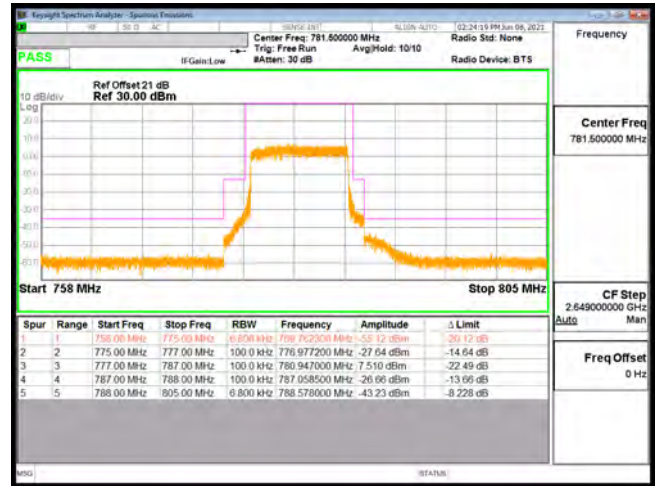

EDGE B13 10M CH23230 16QAM(50,0)

6. Spurious Emission

6.1. Test Specification

According to Part 2.1051, 2.1053, 27.53

6.2. Test Setup

6.2.1 Spurious emissions at antenna terminals.

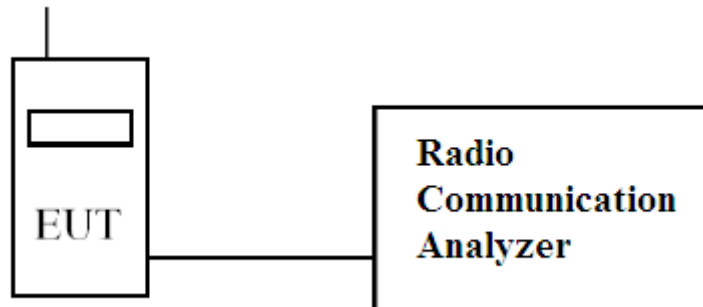

6.2.2 Field strength of spurious radiation.

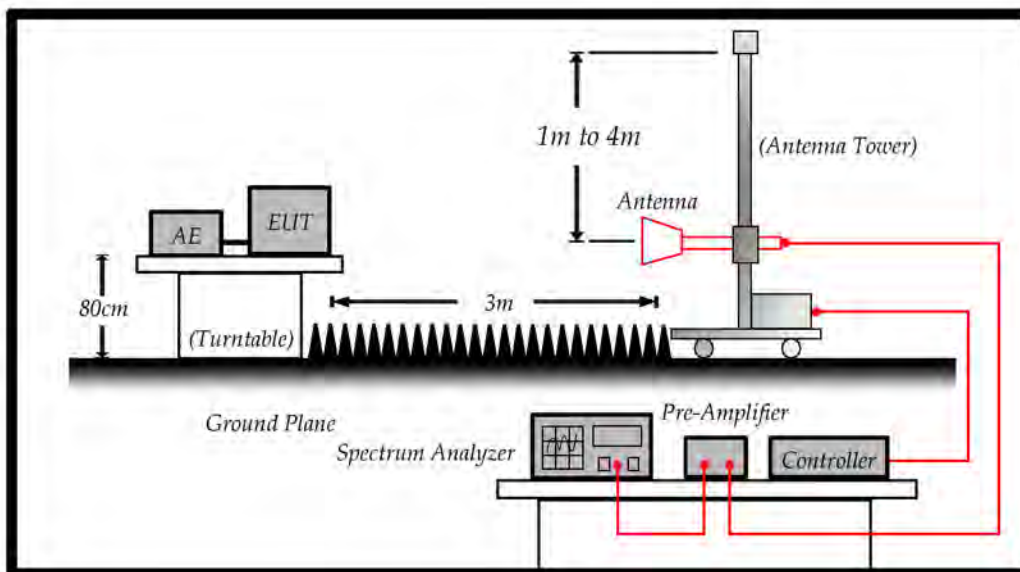

6.3. Limits

Limit	<-13dBm
-------	---------

$43 + 10\log(P)$ down on the carrier where P is the power in Watts.

6.4. Test Procedure

In accordance with Part 2.1051, 2.1053, 27.53, the spurious emissions from the antenna terminal were measured. The transmitter output power was attenuated using a combination of filters and attenuators and the frequency spectrum investigated from 30MHz to 20GHz. The EUT was set to transmit on full power. The EUT was tested on Low, middle and High channels for both power levels. The resolution and video bandwidth was set to 1MHz/3MHz in accordance with Part 2.1051, 2.1053, 27.53. The spectrum analyzer detector was set to Max Hold. In addition, measurements were made up to the 10th harmonic of the fundamental. The device was then replaced with a substitution antenna, which input signal was adjusted until the received level matched that of the previously detected emission.

- (1) The EUT is tested with maximum rated TX power via the Base Station simulator.
- (2) The EUT is tested in three orthogonal planes, The worst case was showing in this report.

The EUT is placed on a turn table which is 1.5 meter above ground. The turn table can rotate 360 degrees to determine the position of the maximum emission level. The EUT was positioned such that the distance from antenna to the EUT was 3 meters. The antenna can move up and down between 1 meter and 4 meters to find out the maximum emission level.

Both horizontal and vertical polarization of the antenna are set on measurement. In order to find the maximum emission, all of the interface cables must be manipulated according to TIA/EIA 603-E on radiated measurement.

27.53 (f) For operations in the 746-758 MHz, 775-788 MHz, and 805-806 MHz bands, emissions in the band 1559-1610 MHz shall be limited to -70 dBW/MHz equivalent isotropically radiated power (EIRP) for wideband signals, and -80 dBW EIRP for discrete emissions of less than 700 Hz bandwidth. For the purpose of equipment authorization, a transmitter shall be tested with an antenna that is representative of the type that will be used with the equipment in normal operation.

6.5. Test Result of Spurious Emission

Product	5G Extender Gen 2		
Test Mode	Spurious Emission (Conducted)		
Date of Test	2021/06/05	Test Site	CTR
Test Condition	LTE-Band 4	Test Range	30MHz~18GHz

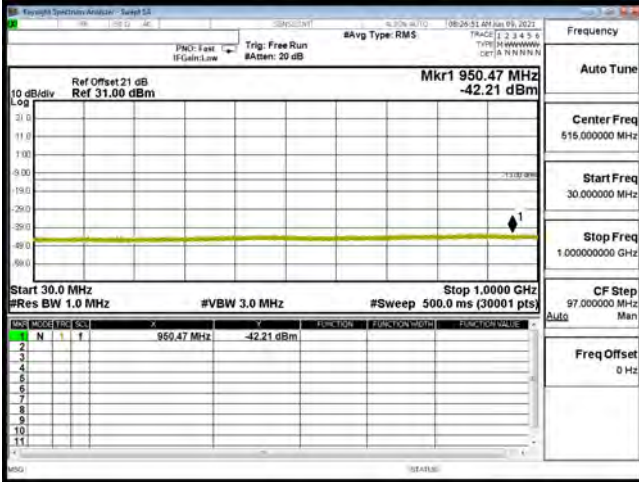

CSE B4 1.4M CH19957 QPSK(1,2) 30M-1G

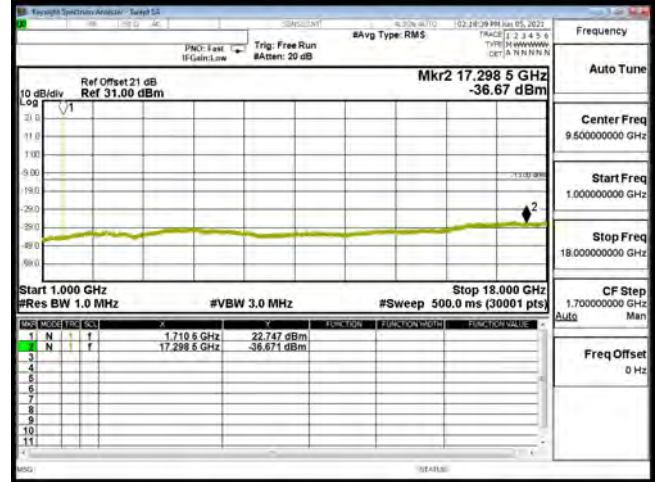

CSE B4 1.4M CH19957 QPSK(1,2) 1G-18G



CSE B4 1.4M CH19957 16QAM(1,2) 30M-1G



CSE B4 1.4M CH19957 16QAM(1,2) 1G-18G

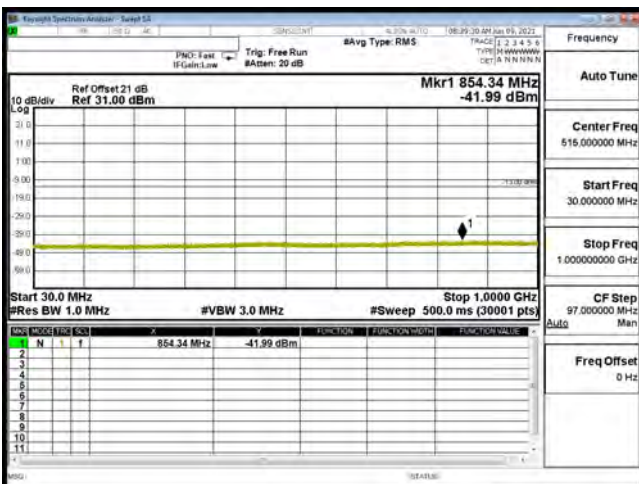

CSE B4 1.4M CH20175 QPSK(1,2) 30M-1G

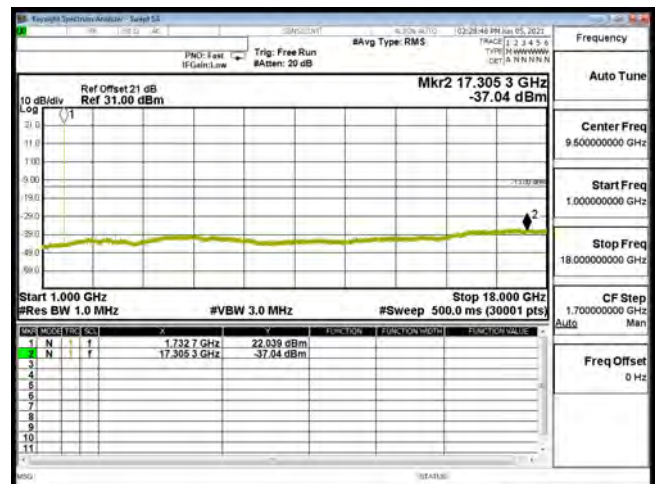

CSE B4 1.4M CH20175 QPSK(1,2) 1G-18G

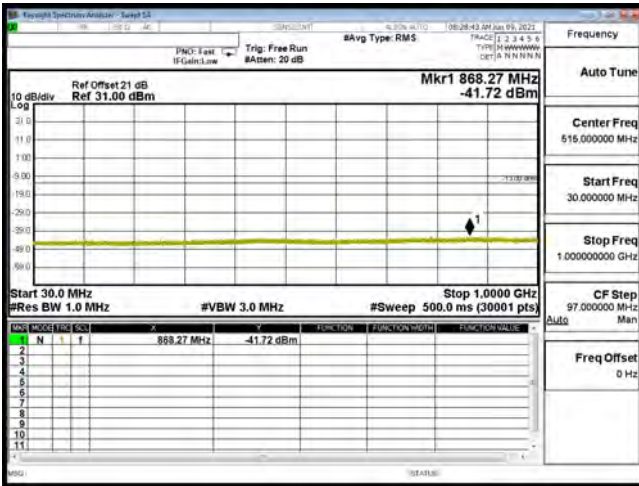

CSE B4 1.4M CH20175 16QAM(3,2) 30M-1G

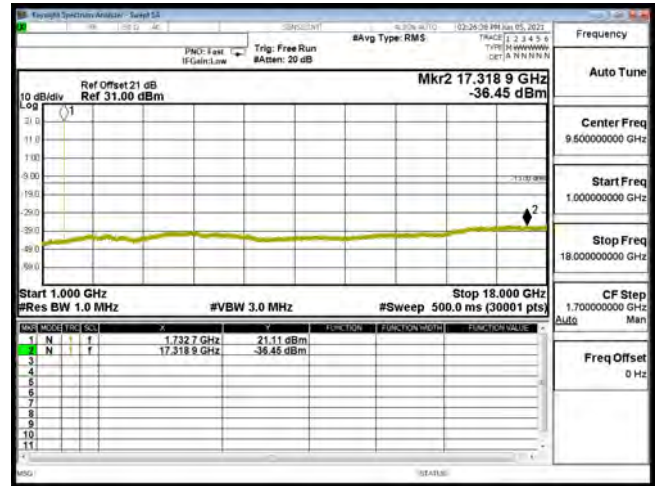

CSE B4 1.4M CH20175 16QAM(3,2) 1G-18G

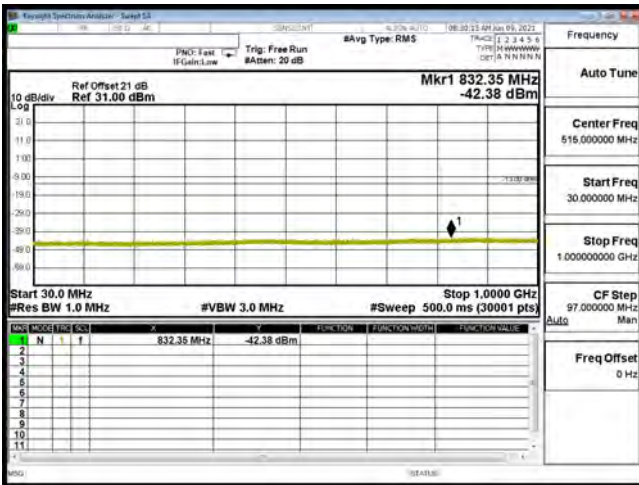

CSE B4 1.4M CH20393 QPSK(1,2) 30M-1G

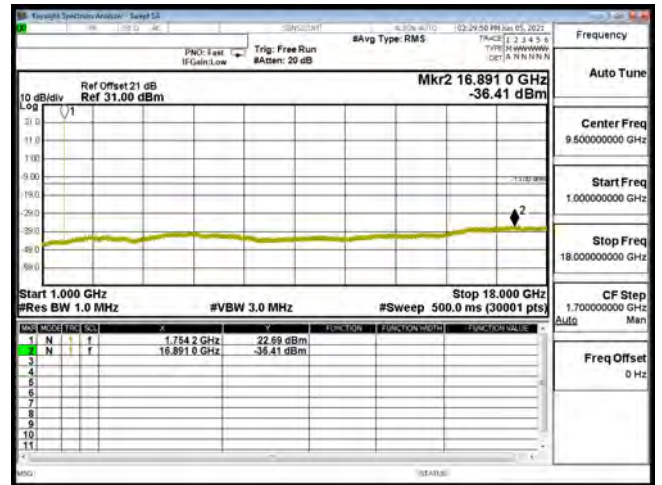

CSE B4 1.4M CH20393 QPSK(1,2) 1G-18G

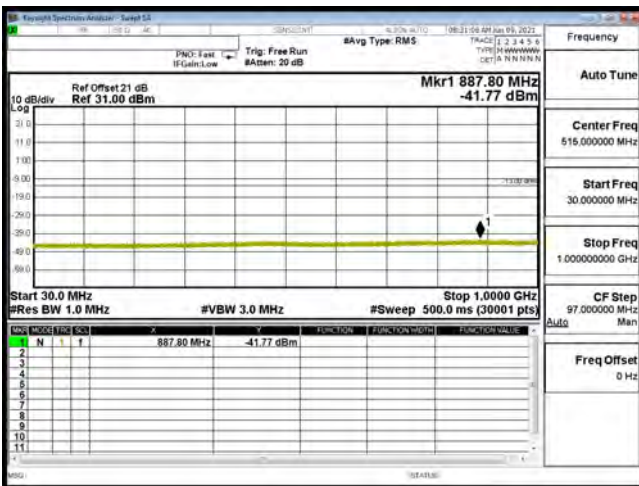

CSE B4 1.4M CH20393 16QAM(3,3) 30M-1G

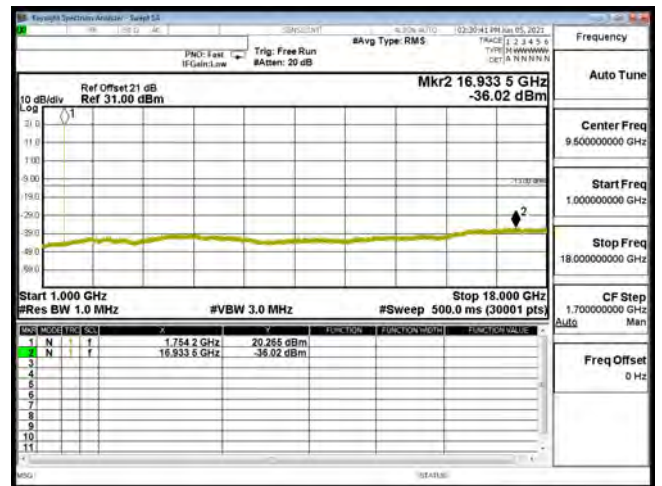

CSE B4 1.4M CH20393 16QAM(3,3) 1G-18G

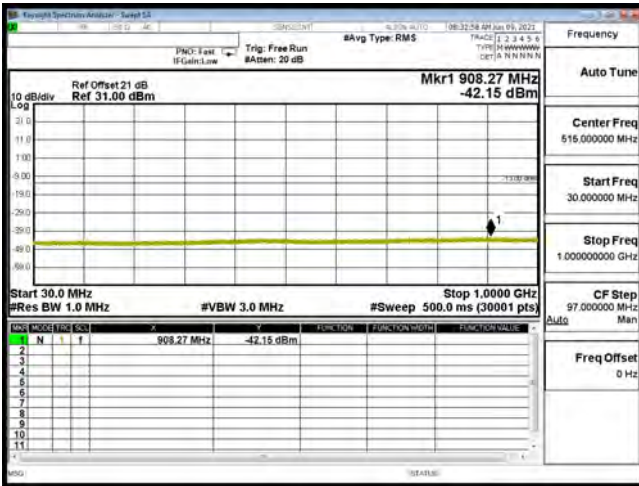

CSE B4 3M CH19965 QPSK(1,7) 30M-1G

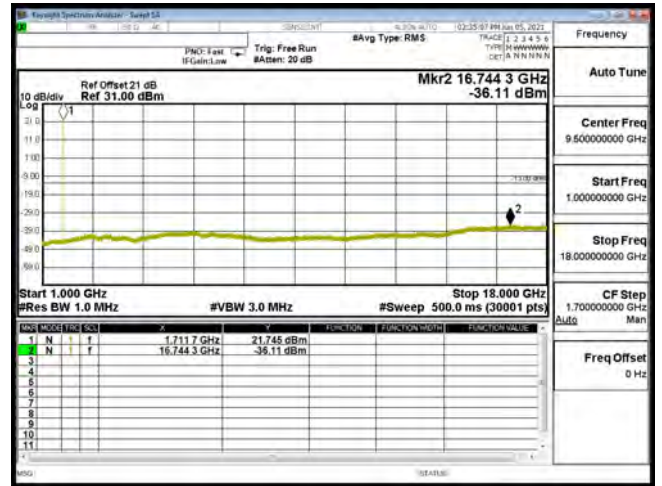

CSE B4 3M CH19965 QPSK(1,7) 1G-18G

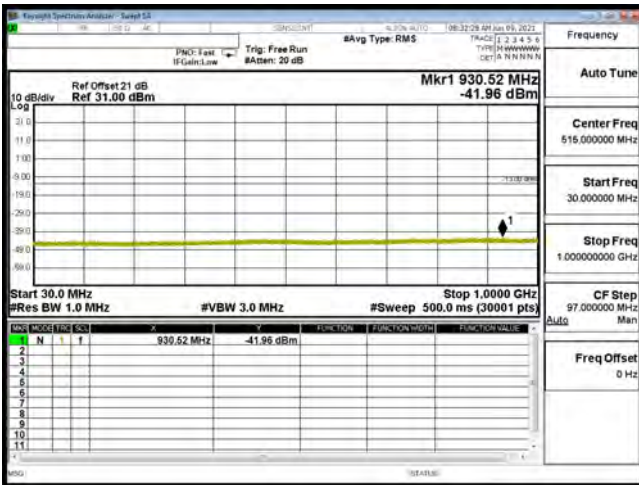

CSE B4 3M CH19965 16QAM(1,7) 30M-1G

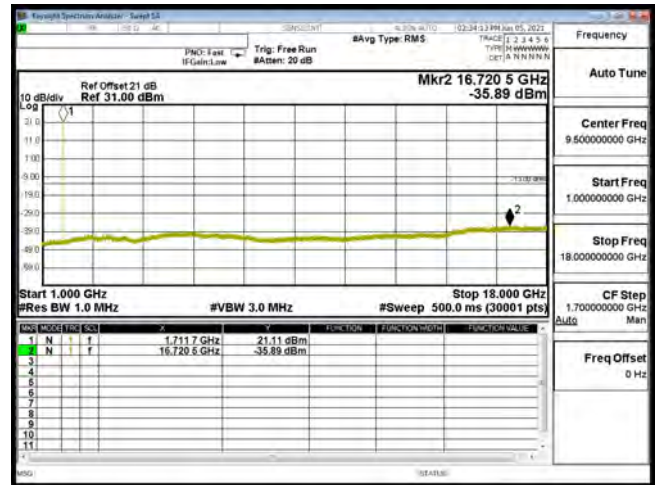

CSE B4 3M CH19965 16QAM(1,7) 1G-18G

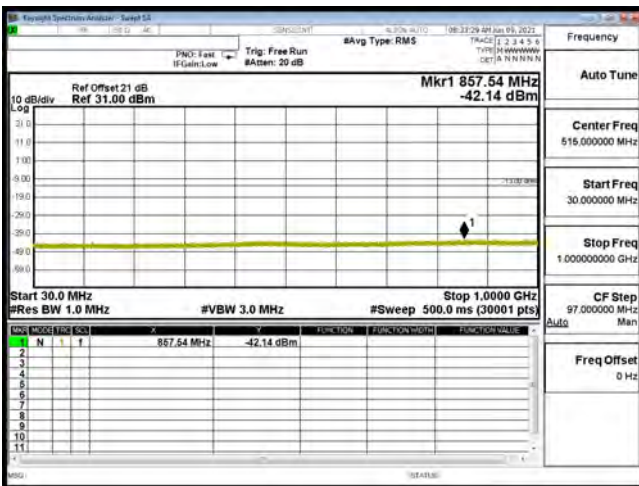

CSE B4 3M CH20175 QPSK(1,7) 30M-1G

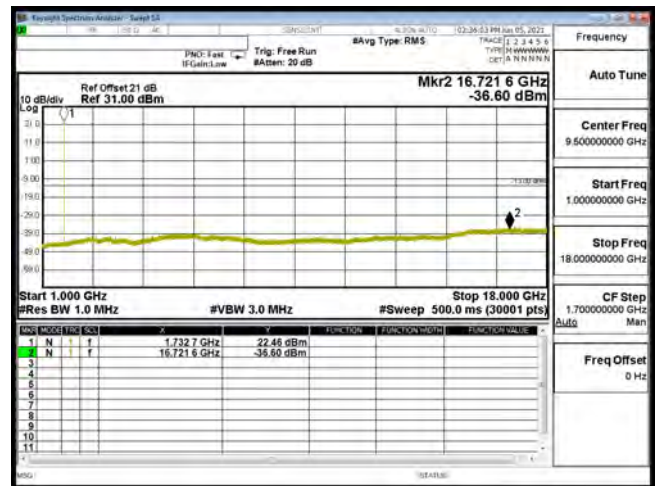

CSE B4 3M CH20175 QPSK(1,7) 1G-18G

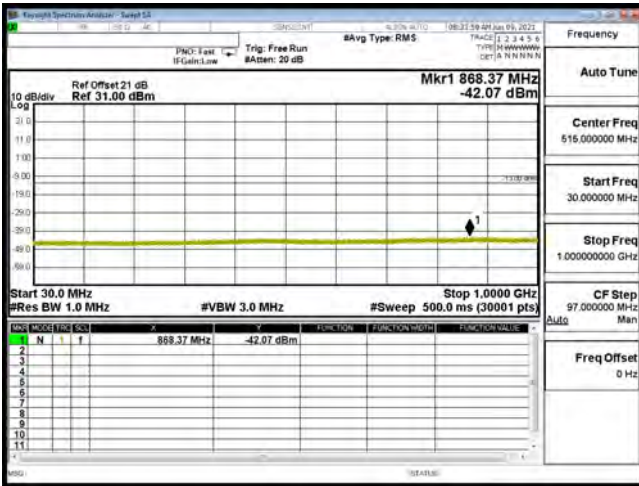

CSE B4 3M CH20175 16QAM(1,7) 30M-1G

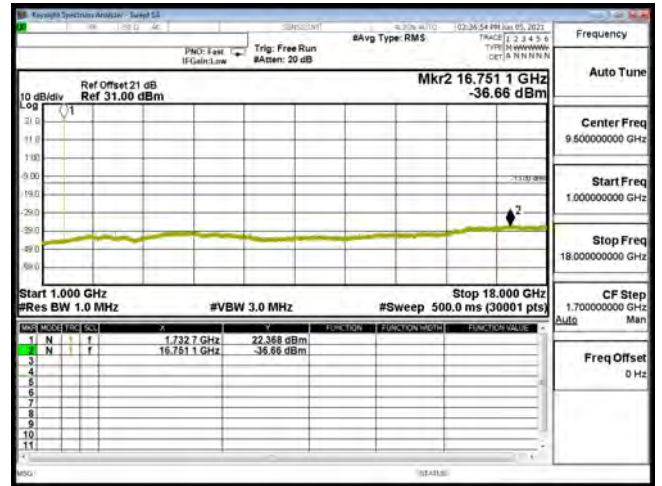

CSE B4 3M CH20175 16QAM(1,7) 1G-18G

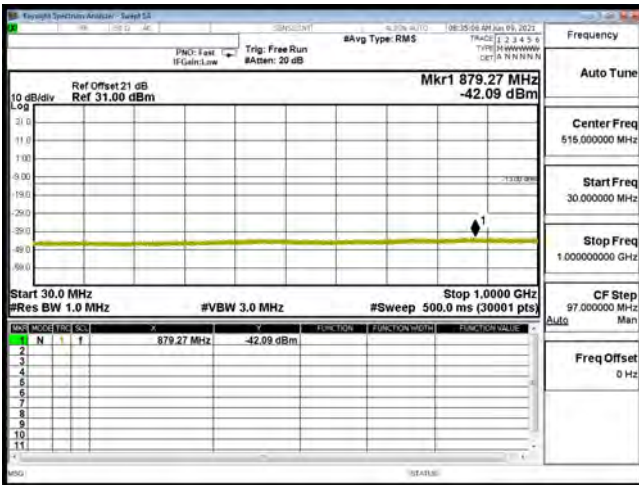

CSE B4 3M CH20385 QPSK(1,7) 30M-1G

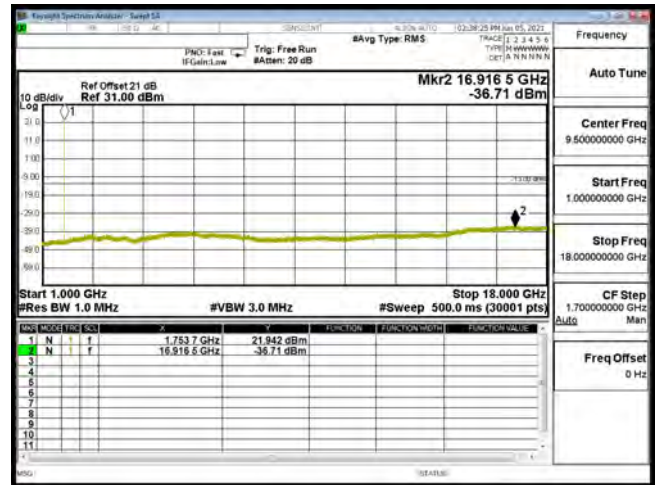

CSE B4 3M CH20385 QPSK(1,7) 1G-18G

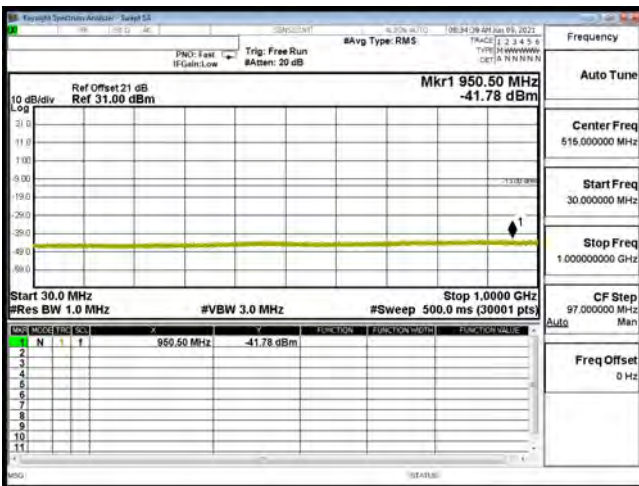

CSE B4 3M CH20385 16QAM(1,7) 30M-1G

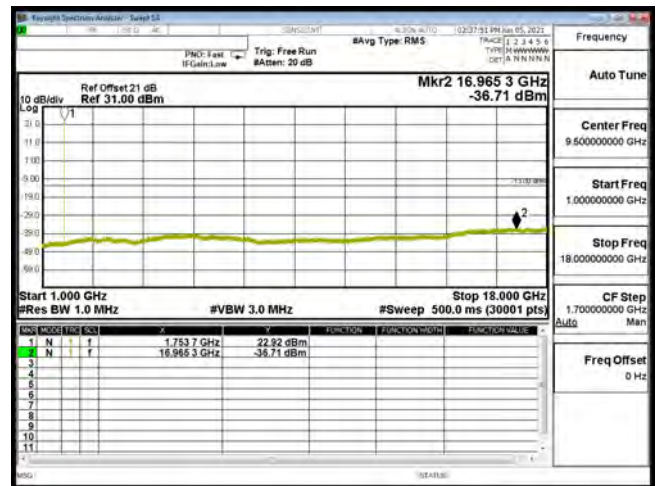

CSE B4 3M CH20385 16QAM(1,7) 1G-18G

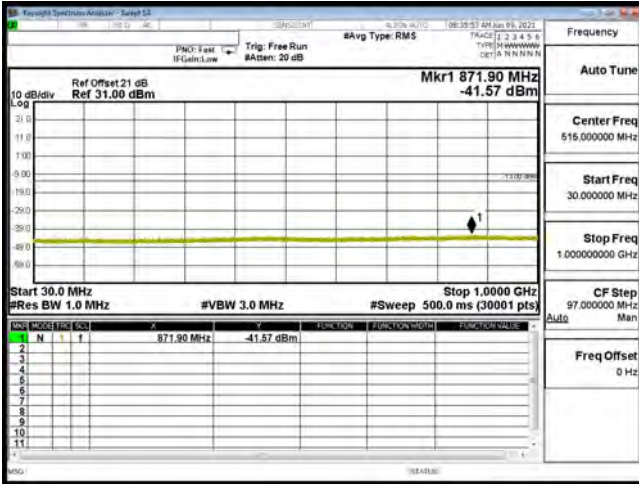

CSE B4 5M CH19975 QPSK(1,12) 30M-1G

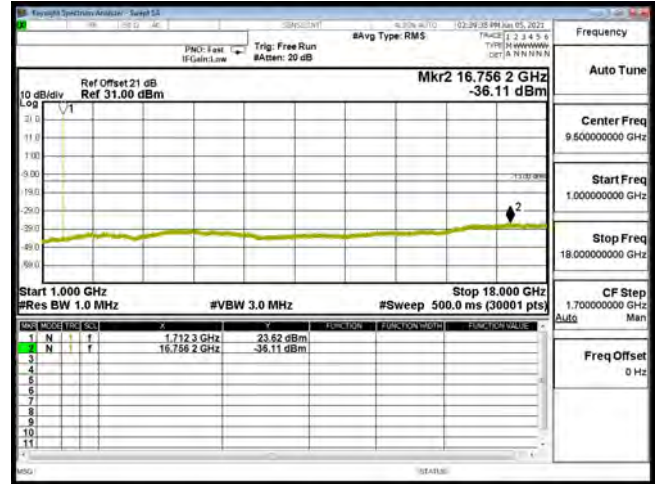

CSE B4 5M CH19975 QPSK(1,12) 1G-18G

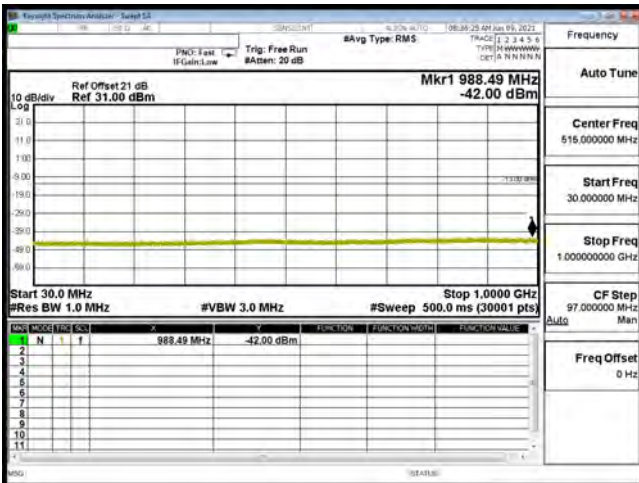

CSE B4 5M CH19975 16QAM(1,12) 30M-1G



CSE B4 5M CH19975 16QAM(1,12) 1G-18G



CSE B4 5M CH20175 QPSK(1,12) 30M-1G



CSE B4 5M CH20175 QPSK(1,12) 1G-18G

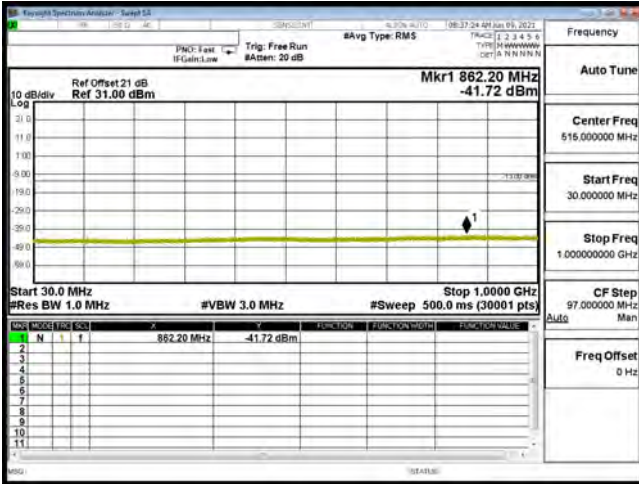

CSE B4 5M CH20175 16QAM(1,12) 30M-1G

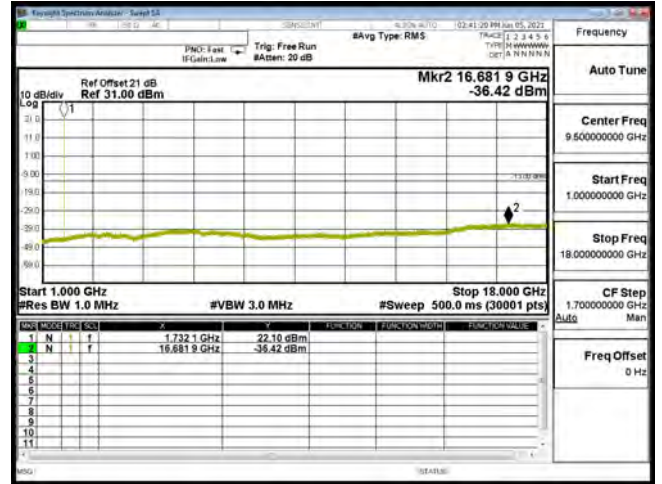

CSE B4 5M CH20175 16QAM(1,12) 1G-18G



CSE B4 5M CH20375 QPSK(1,12) 30M-1G

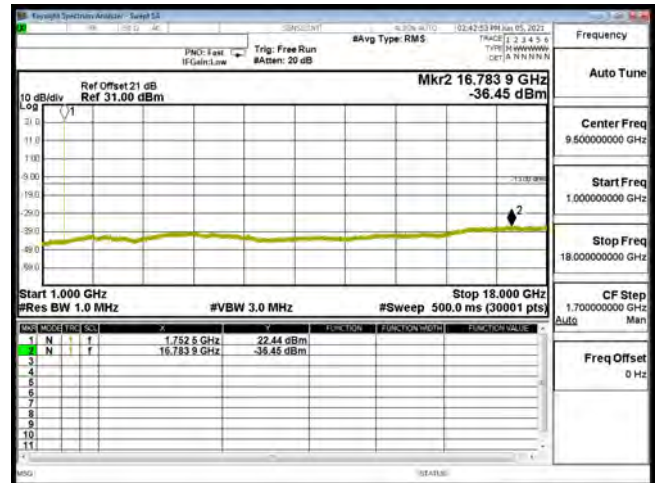

CSE B4 5M CH20375 QPSK(1,12) 1G-18G

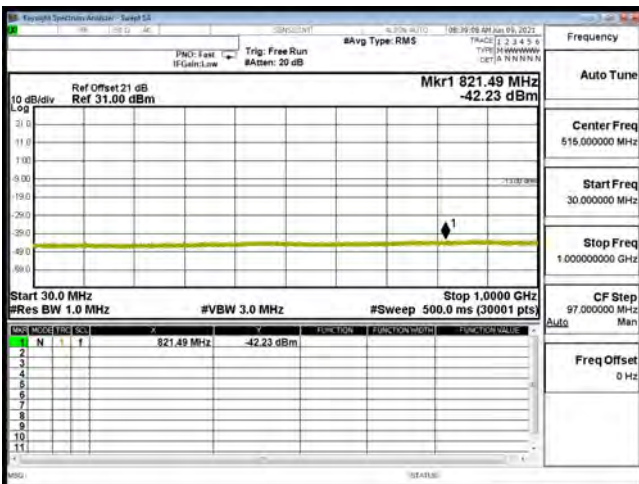

CSE B4 5M CH20375 16QAM(1,12) 30M-1G

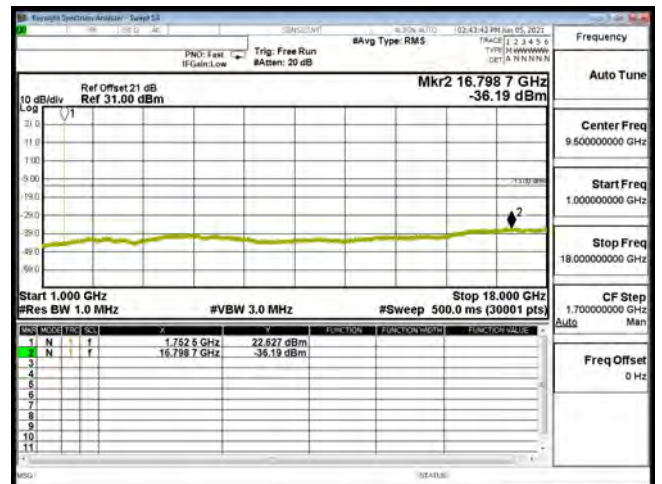

CSE B4 5M CH20375 16QAM(1,12) 1G-18G

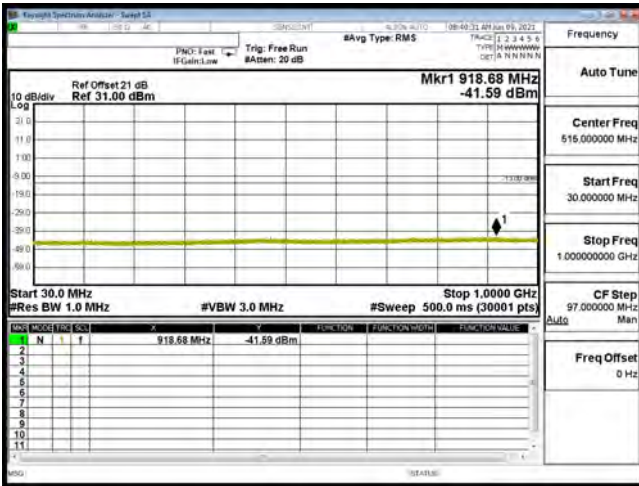

CSE B4 10M CH20000 QPSK(1,0) 30M-1G

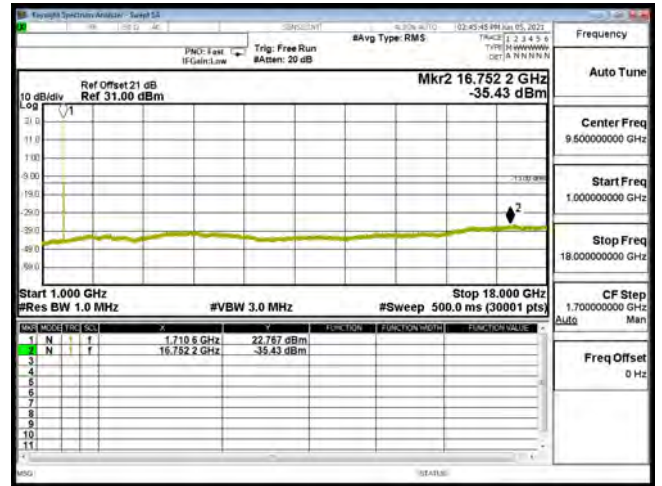

CSE B4 10M CH20000 QPSK(1,0) 1G-18G

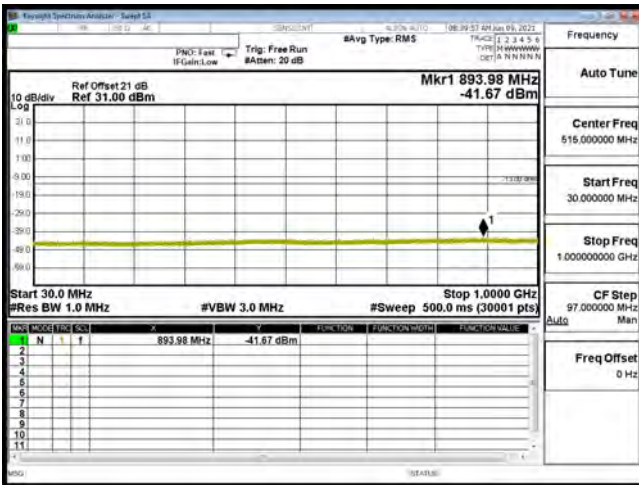

CSE B4 10M CH20000 16QAM(1,0) 30M-1G

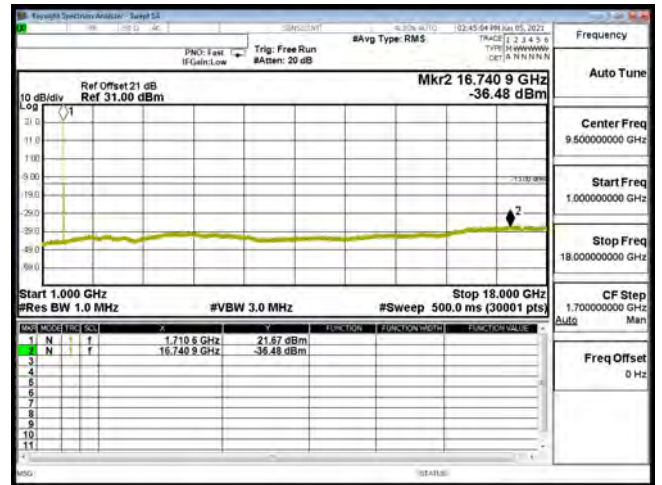

CSE B4 10M CH20000 16QAM(1,0) 1G-18G



CSE B4 10M CH20175 QPSK(1,25) 30M-1G

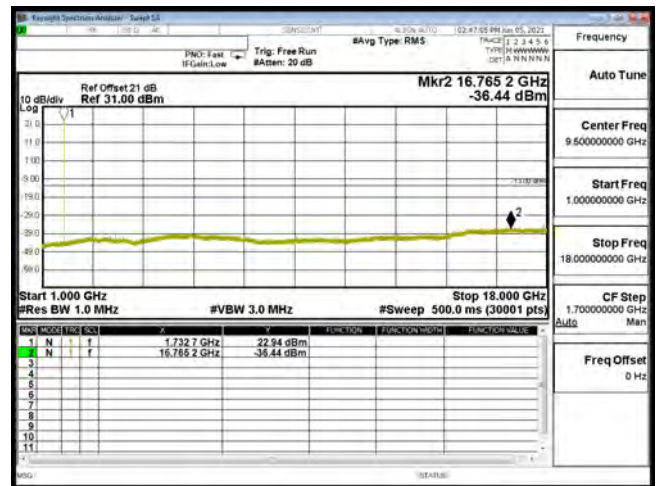

CSE B4 10M CH20175 QPSK(1,25) 1G-18G

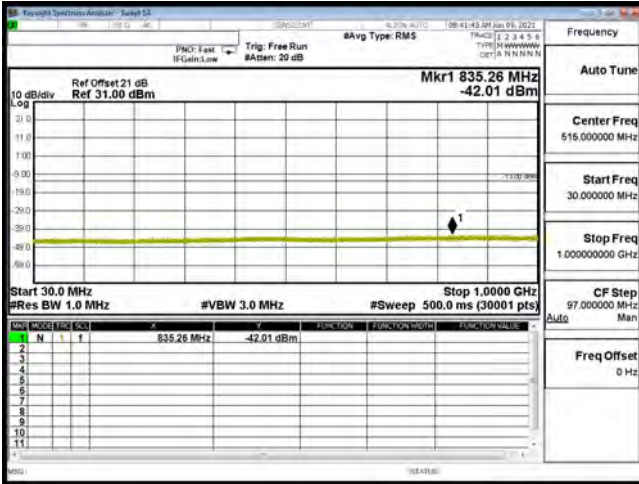

CSE B4 10M CH20175 16QAM(1,25) 30M-1G

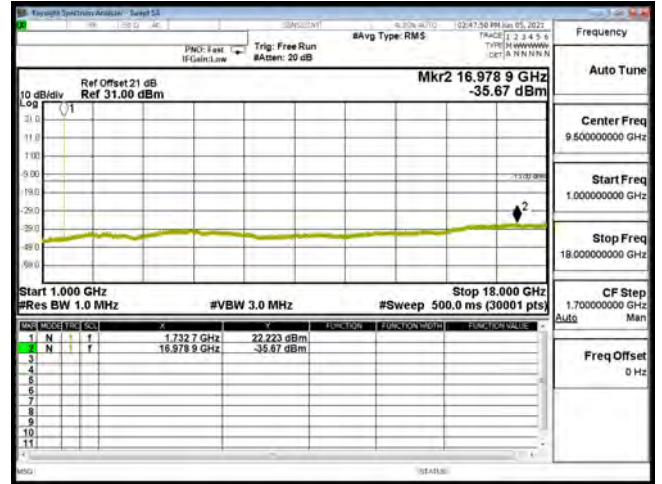

CSE B4 10M CH20175 16QAM(1,25) 1G-18G

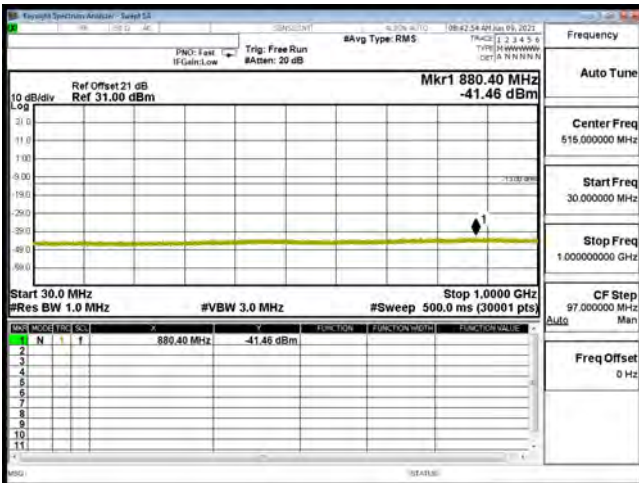

CSE B4 10M CH20350 QPSK(1,49) 30M-1G

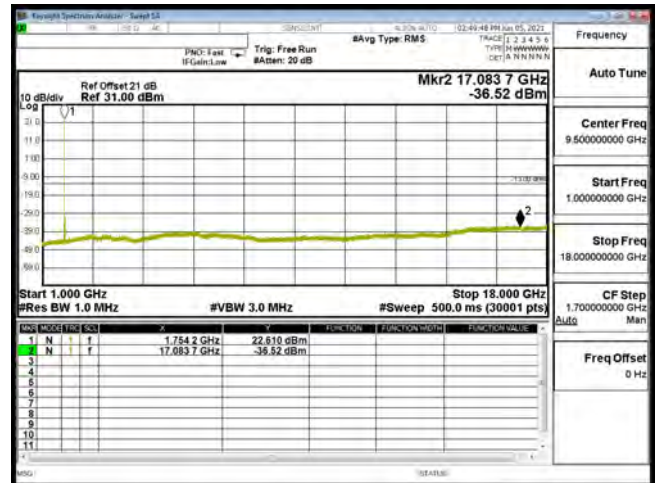

CSE B4 10M CH20350 QPSK(1,49) 1G-18G



CSE B4 10M CH20350 16QAM(1,49) 30M-1G



CSE B4 10M CH20350 16QAM(1,49) 1G-18G

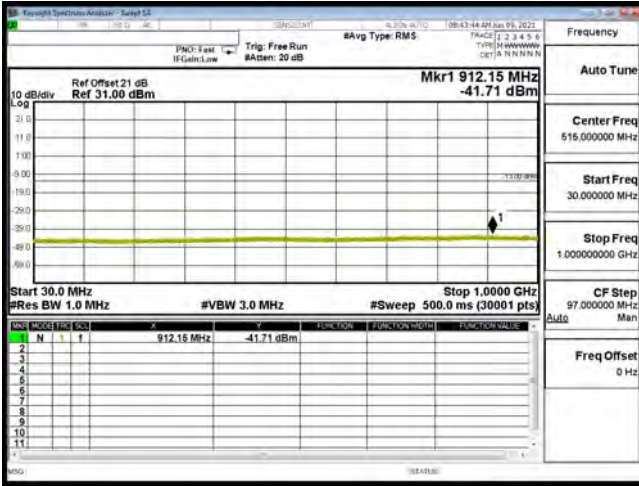

CSE B4 15M CH2025 QPSK(1,0) 30M-1G

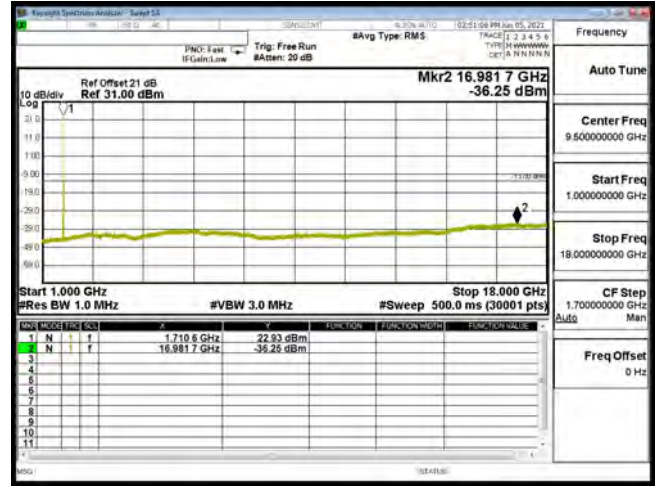

CSE B4 15M CH2025 QPSK(1,0) 1G-18G

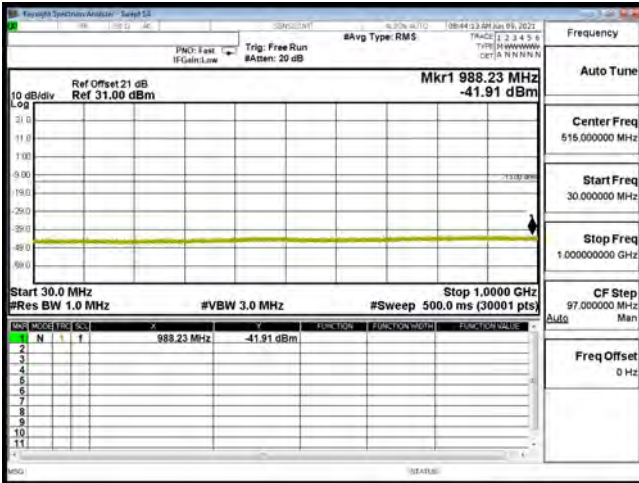

CSE B4 15M CH2025 16QAM(1,0) 30M-1G

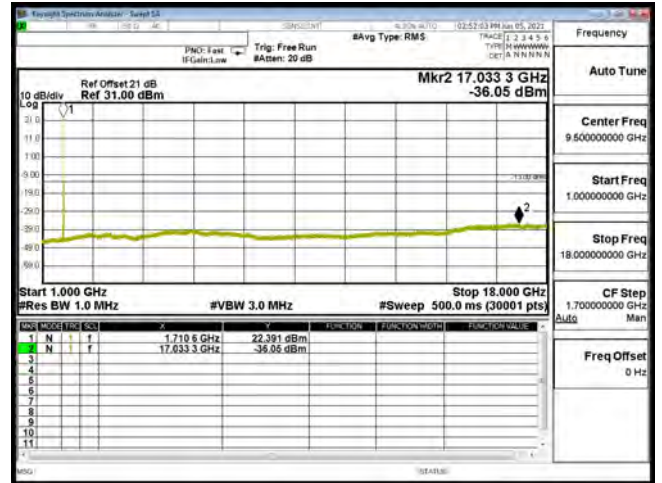

CSE B4 15M CH2025 16QAM(1,0) 1G-18G



CSE B4 15M CH20175 QPSK(1,0) 30M-1G

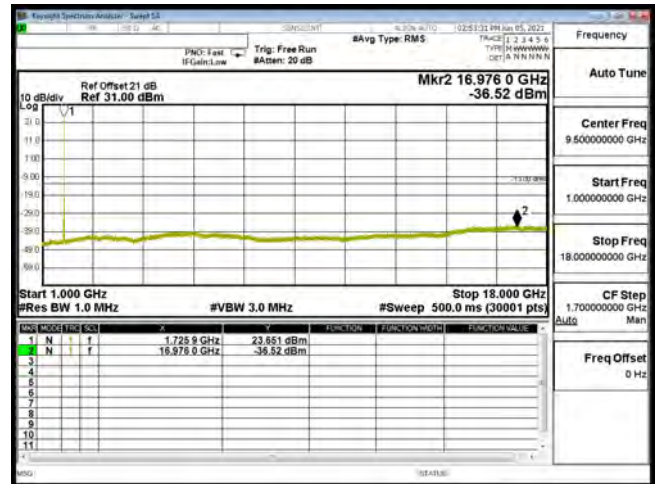

CSE B4 15M CH20175 QPSK(1,0) 1G-18G

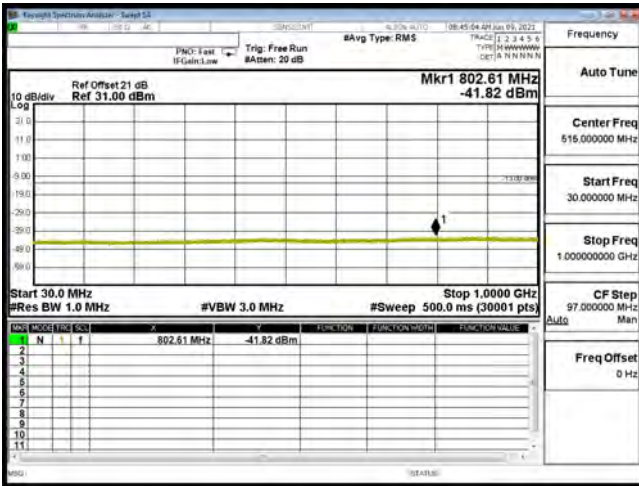

CSE B4 15M CH20175 16QAM(1,0) 30M-1G

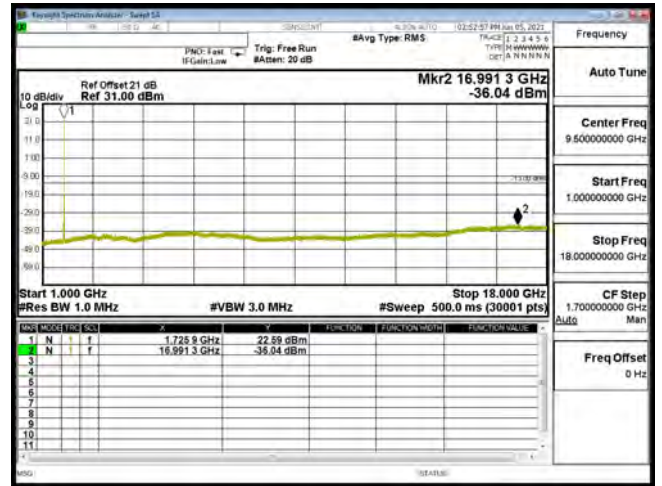

CSE B4 15M CH20175 16QAM(1,0) 1G-18G

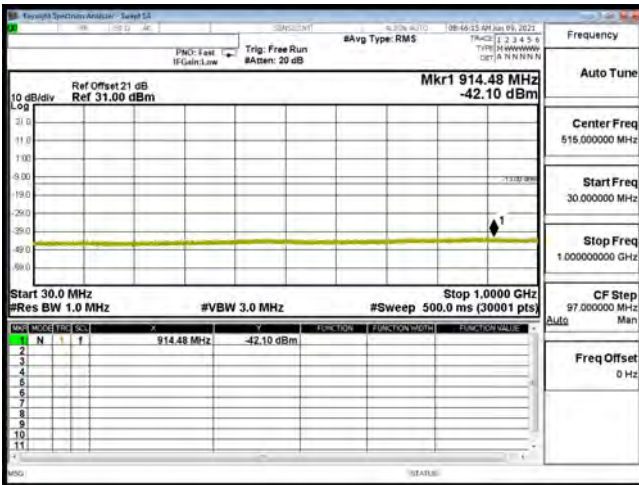

CSE B4 15M CH20325 QPSK(1,0) 30M-1G

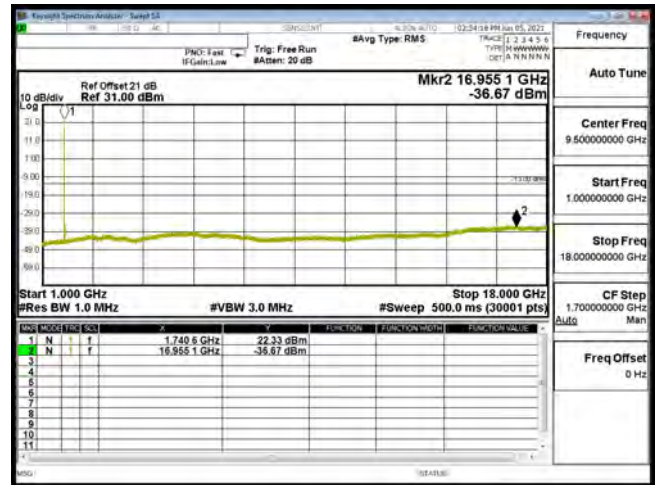

CSE B4 15M CH20325 QPSK(1,0) 1G-18G



CSE B4 15M CH20325 16QAM(1,0) 30M-1G



CSE B4 15M CH20325 16QAM(1,0) 1G-18G

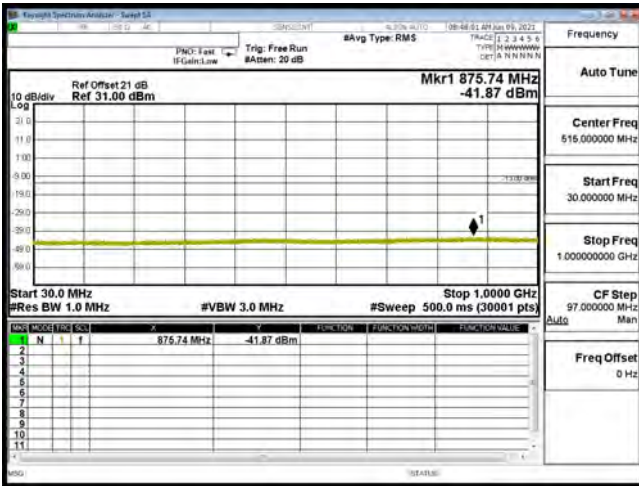

CSE B4 20M CH20050 QPSK(1,0) 30M-1G

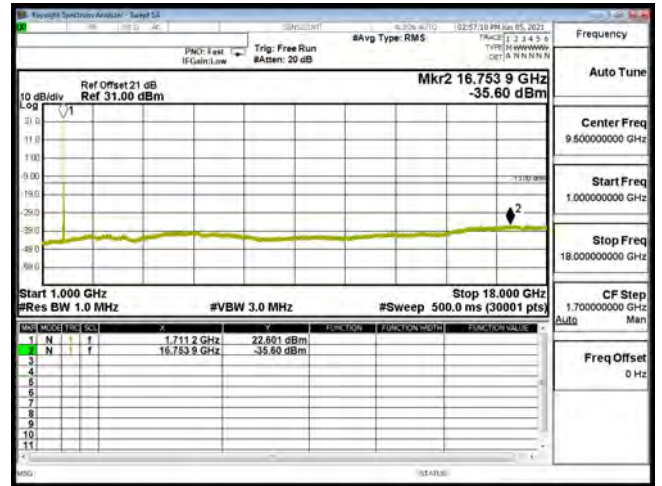

CSE B4 20M CH20050 QPSK(1,0) 1G-18G

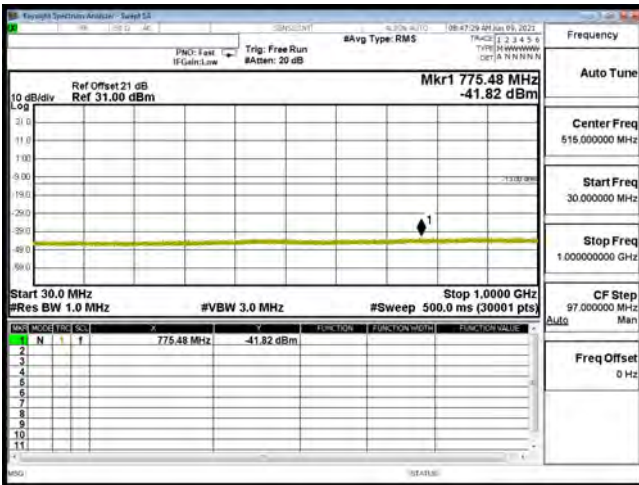

CSE B4 20M CH20050 16QAM(1,0) 30M-1G

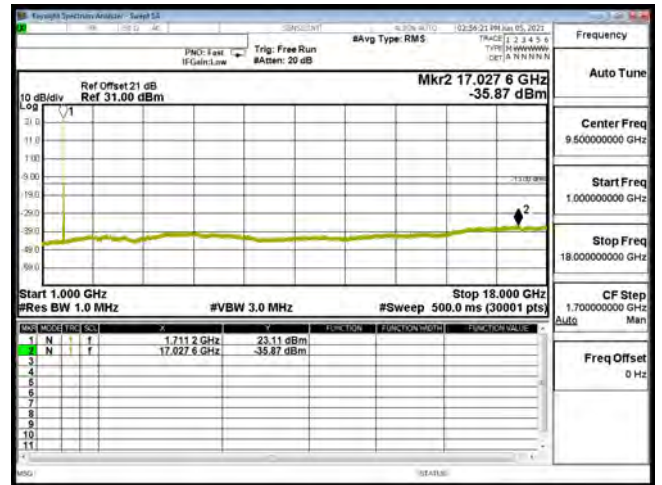

CSE B4 20M CH20050 16QAM(1,0) 1G-18G



CSE B4 20M CH20175 QPSK(1,50) 30M-1G



CSE B4 20M CH20175 QPSK(1,50) 1G-18G



CSE B4 20M CH20175 16QAM(1,50) 30M-1G

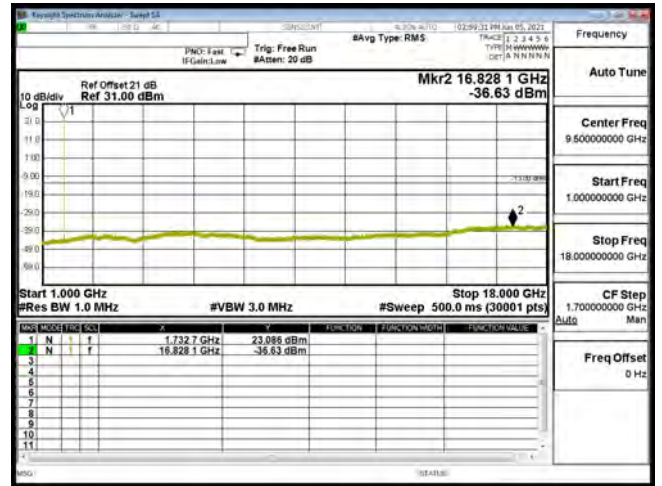

CSE B4 20M CH20175 16QAM(1,50) 1G-18G

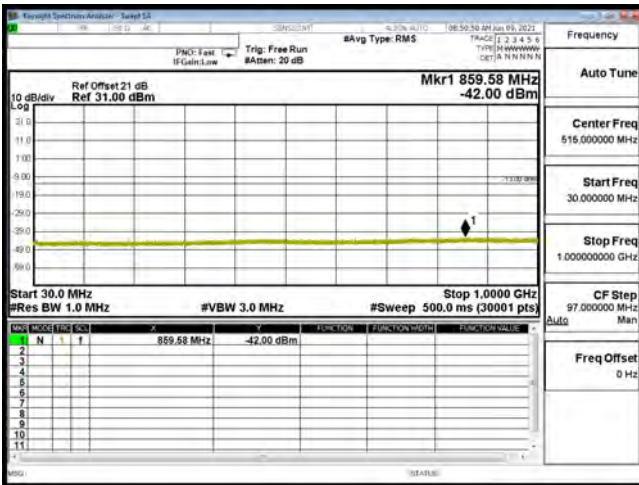

CSE B4 20M CH20300 QPSK(1,0) 30M-1G

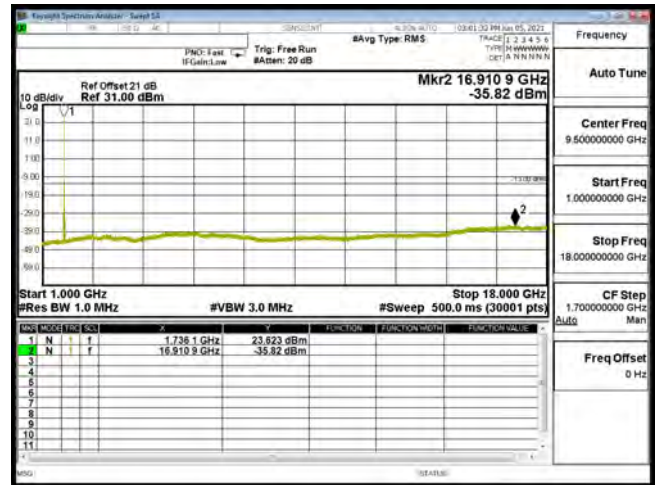

CSE B4 20M CH20300 QPSK(1,0) 1G-18G



CSE B4 20M CH20300 16QAM(1,0) 30M-1G

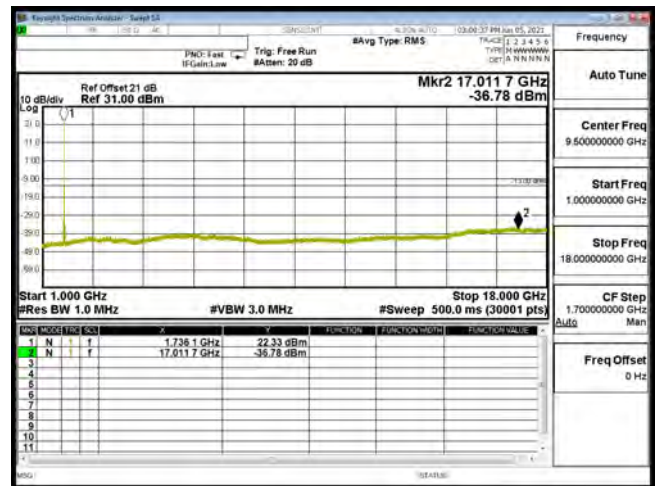

CSE B4 20M CH20300 16QAM(1,0) 1G-18G

Product	5G Extender Gen 2		
Test Mode	Spurious Emission (Conducted)		
Date of Test	2021/06/05	Test Site	CTR
Test Condition	LTE-Band 13	Test Range	30MHz~10GHz

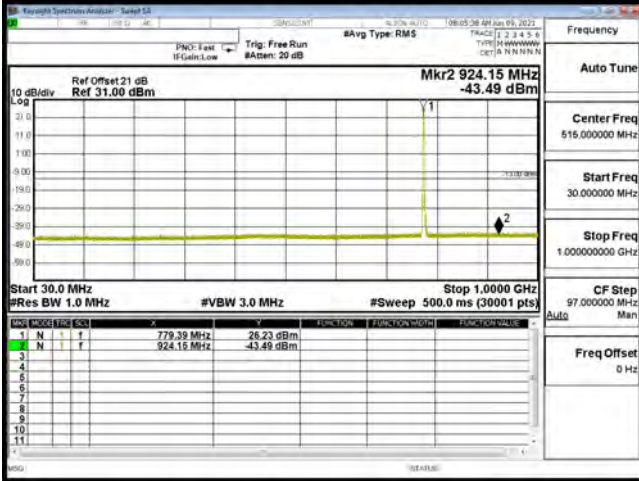

CSE B13 5M CH23205 QPSK(1,12) 30M-1G



CSE B13 5M CH23205 QPSK(1,12) 1G-10G



CSE B13 5M CH23205 16QAM(1,12) 30M-1G

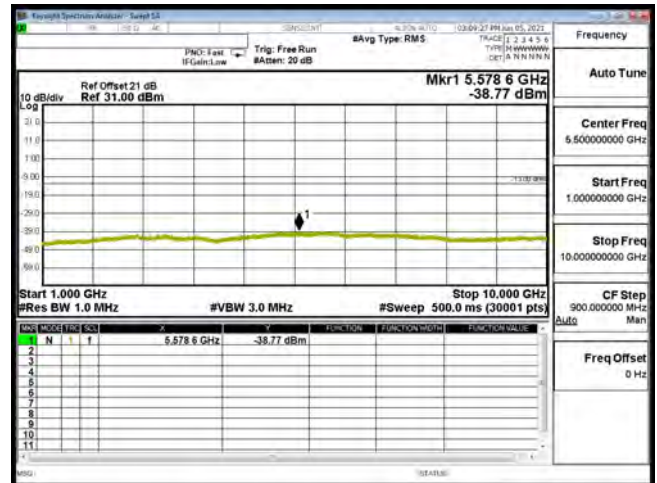

CSE B13 5M CH23205 16QAM(1,12) 1G-10G

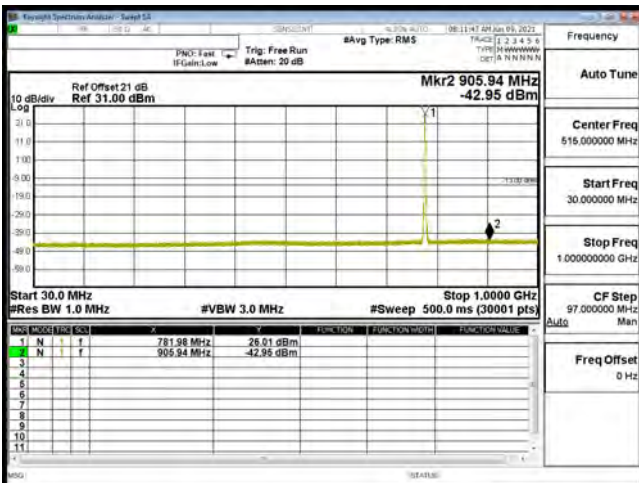

CSE B13 5M CH23230 QPSK(1,12) 30M-1G



CSE B13 5M CH23230 QPSK(1,12) 1G-10G

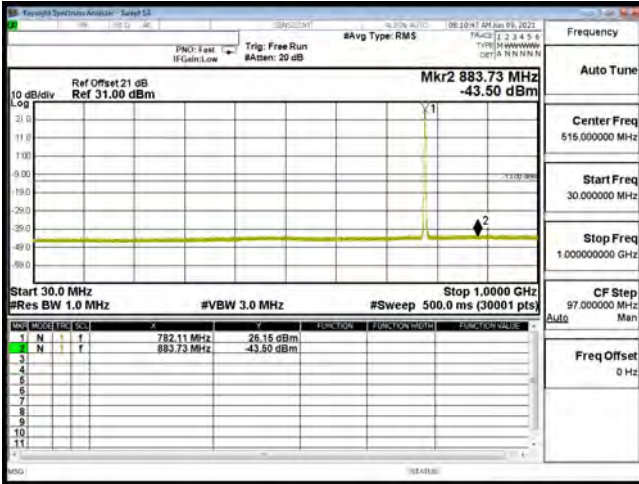

CSE B13 5M CH23230 16QAM(1,12) 30M-1G



CSE B13 5M CH23230 16QAM(1,12) 1G-10G



CSE B13 5M CH23255 QPSK(1,12) 30M-1G

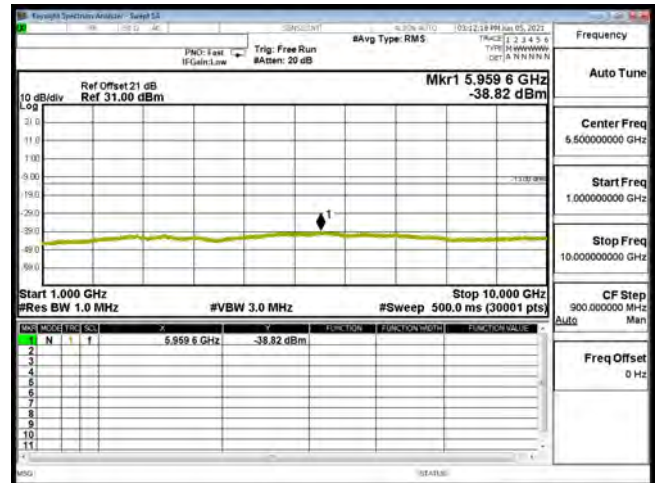

CSE B13 5M CH23255 QPSK(1,12) 1G-10G



CSE B13 5M CH23255 16QAM(1,12) 30M-1G

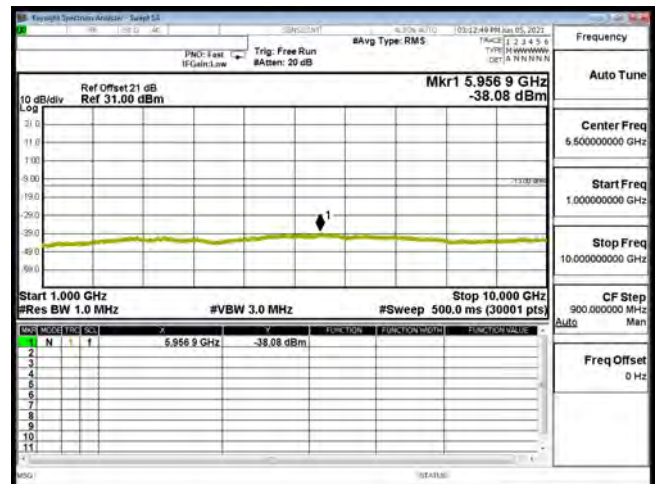

CSE B13 5M CH23255 16QAM(1,12) 1G-10G

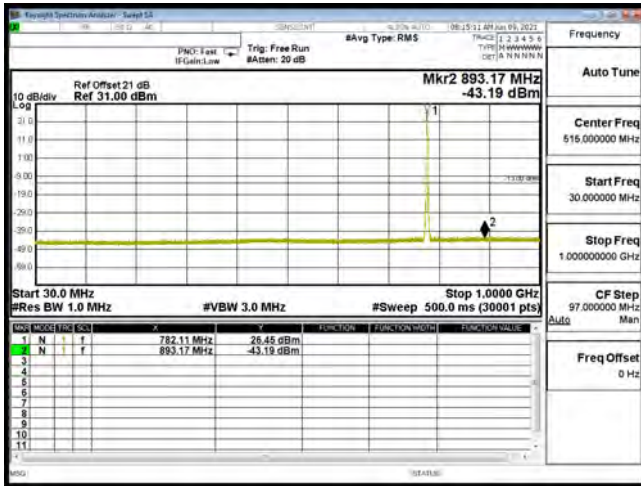

CSE B13 10M CH23230 QPSK(1,25) 30M-1G

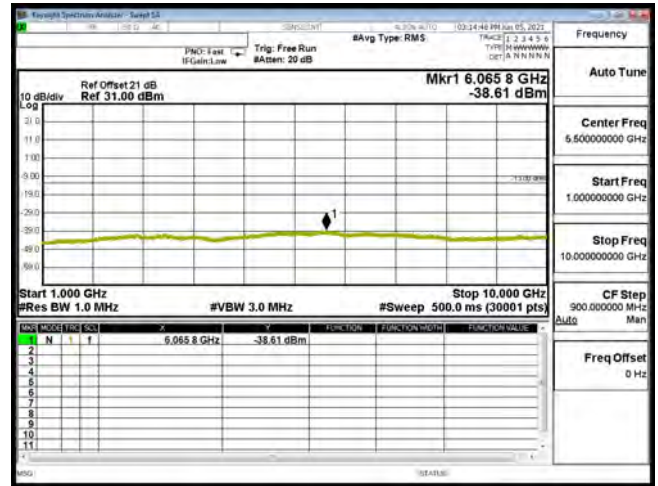

CSE B13 10M CH23230 QPSK(1,25) 1G-10G

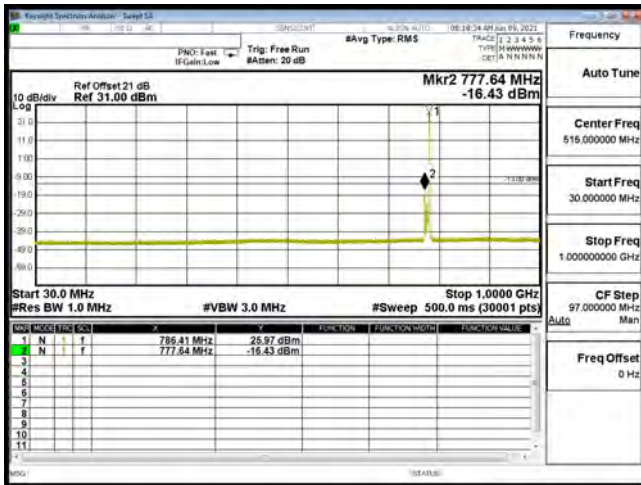

CSE B13 10M CH23230 16QAM(1,49) 30M-1G

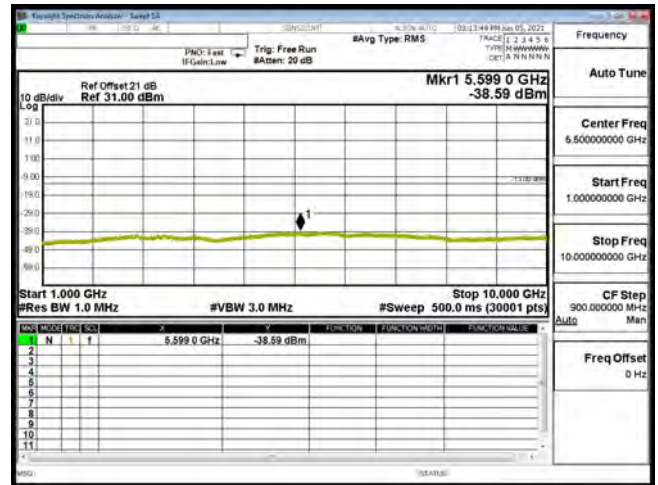

CSE B13 10M CH23230 16QAM(1,49) 1G-10G

Product	5G Extender Gen 2		
Test Mode	Spurious Emission (Radiated) - Multi Band Dipole Antenna (STAF)		
Date of Test	2021/06/11	Test Site	Site3
Test Condition	Band 4 (1.4M) QPSK	Test Range	9kHz ~20GHz

Polarity	Frequency	Reading Level	Signal Generator Level	Cable Loss	Antenna Gain	EIRP Value	Limit
	(GHz)	(dBm)	(dBm)	(dB)	(dBi)	(dBm)	(dBm)
Low Channel: 19957, Frequency: 1710.7MHz RB/RB Offset: 1@2							
Horizontal	3421	-41.60	-55.15	2.52	12.58	-45.09	-13
Horizontal	5132	-39.60	-47.41	3.29	12.46	-38.24	-13
Horizontal	6843	-54.04	-58.23	3.64	11.50	-50.37	-13
Vertical	3421	-41.41	-55.17	2.52	12.58	-45.11	-13
Vertical	5132	-39.18	-47.66	3.29	12.46	-38.49	-13
Vertical	6843	-55.63	-60.15	3.64	11.50	-52.29	-13
Mid Channel: 20175, Frequency: 1732.5MHz RB/RB Offset: 1@2							
Horizontal	3465	-40.81	-53.79	2.53	12.60	-43.72	-13
Horizontal	5198	-39.75	-48.24	3.11	12.94	-38.41	-13
Horizontal	6930	-53.78	-58.09	3.65	11.50	-50.24	-13
Vertical	3465	-41.41	-54.88	2.53	12.60	-44.81	-13
Vertical	5198	-39.62	-48.51	3.11	12.94	-38.68	-13
Vertical	6930	-55.14	-59.69	3.65	11.50	-51.84	-13
High Channel: 20393, Frequency: 1754.3MHz RB/RB Offset: 1@2							
Horizontal	3509	-39.07	-51.40	2.66	12.60	-41.46	-13
Horizontal	5263	-44.79	-53.12	3.07	13.00	-43.19	-13
Horizontal	7017	-54.70	-58.94	3.91	11.50	-51.35	-13
Vertical	3509	-42.32	-55.29	2.66	12.60	-45.35	-13
Vertical	5263	-42.53	-51.80	3.07	13.00	-41.87	-13
Vertical	7017	-55.82	-60.10	3.91	11.50	-52.51	-13

Note:

1. Receiver setting (Peak Detector) : RBW:1MHz; VBW:3MHz
2. ERP Value = Signal Generator Level + Antenna Gain - Cable Loss
3. Spurious emissions past 8 GHz are not shown, due to the magnitude of spurious emissions attenuated more than 20 dB below the limit.

Product	5G Extender Gen 2		
Test Mode	Spurious Emission (Radiated) - Multi Band Dipole Antenna (STAF)		
Date of Test	2021/06/11	Test Site	Site3
Test Condition	Band 4 (3M) QPSK	Test Range	9kHz ~20GHz

Polarity	Frequency	Reading Level	Signal Generator Level	Cable Loss	Antenna Gain	EIRP Value	Limit
	(GHz)	(dBm)	(dBm)	(dB)	(dBi)	(dBm)	(dBm)
Low Channel: 19965, Frequency: 1711.5MHz RB/RB Offset: 1@7							
Horizontal	3423	-40.19	-53.72	2.52	12.58	-43.66	-13
Horizontal	5135	-38.96	-46.80	3.28	12.48	-37.60	-13
Horizontal	6846	-53.31	-57.50	3.64	11.50	-49.64	-13
Vertical	3423	-41.44	-55.18	2.52	12.58	-45.12	-13
Vertical	5135	-38.54	-47.04	3.28	12.48	-37.84	-13
Vertical	6846	-54.03	-58.55	3.64	11.50	-50.69	-13
Mid Channel: 20175, Frequency: 1732.5MHz RB/RB Offset: 1@7							
Horizontal	3465	-39.66	-52.64	2.53	12.60	-42.57	-13
Horizontal	5198	-40.35	-48.84	3.11	12.94	-39.01	-13
Horizontal	6930	-54.66	-58.97	3.65	11.50	-51.12	-13
Vertical	3465	-40.40	-53.87	2.53	12.60	-43.80	-13
Vertical	5198	-39.21	-48.10	3.11	12.94	-38.27	-13
Vertical	6930	-54.18	-58.73	3.65	11.50	-50.88	-13
High Channel: 20385, Frequency: 1753.5MHz RB/RB Offset: 1@7							
Horizontal	3507	-38.93	-51.27	2.66	12.60	-41.33	-13
Horizontal	5261	-44.35	-52.70	3.06	13.00	-42.76	-13
Horizontal	7014	-53.01	-57.28	3.90	11.50	-49.68	-13
Vertical	3507	-43.67	-56.67	2.66	12.60	-46.73	-13
Vertical	5261	-42.74	-52.01	3.06	13.00	-42.07	-13
Vertical	7014	-55.40	-59.71	3.90	11.50	-52.11	-13

Note:

1. Receiver setting (Peak Detector) : RBW:1MHz; VBW:3MHz
2. ERP Value = Signal Generator Level + Antenna Gain - Cable Loss
3. Spurious emissions past 8 GHz are not shown, due to the magnitude of spurious emissions attenuated more than 20 dB below the limit.

Product	5G Extender Gen 2		
Test Mode	Spurious Emission (Radiated) - Multi Band Dipole Antenna (STAF)		
Date of Test	2021/06/11	Test Site	Site3
Test Condition	Band 4 (5M) QPSK	Test Range	9kHz ~20GHz

Polarity	Frequency	Reading Level	Signal Generator Level	Cable Loss	Antenna Gain	EIRP Value	Limit
	(GHz)	(dBm)	(dBm)	(dB)	(dBi)	(dBm)	(dBm)
Low Channel: 19975, Frequency: 1712.5MHz RB/RB Offset: 1@12							
Horizontal	3425	-39.38	-52.88	2.52	12.58	-42.82	-13
Horizontal	5138	-38.08	-45.95	3.28	12.50	-36.72	-13
Horizontal	6850	-53.82	-58.01	3.64	11.50	-50.15	-13
Vertical	3425	-41.19	-54.92	2.52	12.58	-44.86	-13
Vertical	5138	-37.90	-46.42	3.28	12.50	-37.19	-13
Vertical	6850	-54.32	-58.84	3.64	11.50	-50.98	-13
Mid Channel: 20175, Frequency: 1732.5MHz RB/RB Offset: 1@12							
Horizontal	3465	-39.64	-52.62	2.53	12.60	-42.55	-13
Horizontal	5198	-40.22	-48.71	3.11	12.94	-38.88	-13
Horizontal	6930	-53.89	-58.20	3.65	11.50	-50.35	-13
Vertical	3465	-39.77	-53.24	2.53	12.60	-43.17	-13
Vertical	5198	-38.86	-47.75	3.11	12.94	-37.92	-13
Vertical	6930	-55.50	-60.05	3.65	11.50	-52.20	-13
High Channel: 20375, Frequency: 1752.5MHz RB/RB Offset: 1@12							
Horizontal	3505	-37.96	-50.32	2.65	12.60	-40.37	-13
Horizontal	5258	-44.48	-52.85	3.06	13.01	-42.90	-13
Horizontal	7010	-53.93	-58.23	3.89	11.50	-50.62	-13
Vertical	3505	-43.05	-56.09	2.65	12.60	-46.14	-13
Vertical	5258	-43.03	-52.29	3.06	13.01	-42.34	-13
Vertical	7010	-54.78	-59.12	3.89	11.50	-51.51	-13

Note:

1. Receiver setting (Peak Detector) : RBW:1MHz; VBW:3MHz
2. ERP Value = Signal Generator Level + Antenna Gain - Cable Loss
3. Spurious emissions past 8 GHz are not shown, due to the magnitude of spurious emissions attenuated more than 20 dB below the limit.

Product	5G Extender Gen 2		
Test Mode	Spurious Emission (Radiated) - Multi Band Dipole Antenna (STAF)		
Date of Test	2021/06/11	Test Site	Site3
Test Condition	Band 4 (10M) QPSK	Test Range	9kHz ~20GHz

Polarity	Frequency	Reading Level	Signal Generator Level	Cable Loss	Antenna Gain	EIRP Value	Limit
	(GHz)	(dBm)	(dBm)	(dB)	(dBi)	(dBm)	(dBm)
Low Channel: 20000, Frequency: 1715MHz RB/RB Offset: 1@0							
Horizontal	3430	-40.42	-53.98	2.52	12.58	-43.92	-13
Horizontal	5145	-39.03	-46.97	3.25	12.55	-37.67	-13
Horizontal	6860	-56.74	-60.93	3.64	11.50	-53.07	-13
Vertical	3430	-41.59	-55.35	2.52	12.58	-45.29	-13
Vertical	5145	-39.21	-47.82	3.25	12.55	-38.52	-13
Vertical	6860	-56.33	-60.85	3.64	11.50	-52.99	-13
Mid Channel: 20175, Frequency: 1732.5MHz RB/RB Offset: 1@25							
Horizontal	3465	-39.07	-52.04	2.53	12.60	-41.97	-13
Horizontal	5198	-39.90	-48.39	3.11	12.94	-38.56	-13
Horizontal	6930	-53.87	-58.18	3.65	11.50	-50.33	-13
Vertical	3465	-40.85	-54.32	2.53	12.60	-44.25	-13
Vertical	5198	-39.46	-48.35	3.11	12.94	-38.52	-13
Vertical	6930	-55.03	-59.59	3.65	11.50	-51.74	-13
High Channel: 20350, Frequency: 1750MHz RB/RB Offset: 1@49							
Horizontal	3500	-39.32	-51.67	2.64	12.60	-41.71	-13
Horizontal	5250	-46.02	-54.44	3.06	13.03	-44.47	-13
Horizontal	7000	-44.31	-50.35	3.86	11.50	-42.71	-13
Vertical	3500	-43.06	-56.05	2.64	12.60	-46.09	-13
Vertical	5250	-43.58	-52.89	3.06	13.03	-42.92	-13
Vertical	7000	-55.14	-59.57	3.86	11.50	-51.93	-13

Note:

1. Receiver setting (Peak Detector) : RBW:1MHz; VBW:3MHz
2. ERP Value = Signal Generator Level + Antenna Gain - Cable Loss
3. Spurious emissions past 8 GHz are not shown, due to the magnitude of spurious emissions attenuated more than 20 dB below the limit.

Product	5G Extender Gen 2		
Test Mode	Spurious Emission (Radiated) - Multi Band Dipole Antenna (STAF)		
Date of Test	2021/06/11	Test Site	Site3
Test Condition	Band 4 (15M) QPSK	Test Range	9kHz ~20GHz

Polarity	Frequency	Reading Level	Signal Generator Level	Cable Loss	Antenna Gain	EIRP Value	Limit
	(GHz)	(dBm)	(dBm)	(dB)	(dBi)	(dBm)	(dBm)
Low Channel: 20025, Frequency: 1717.5MHz RB/RB Offset: 1@0							
Horizontal	3435	-41.46	-55.01	2.52	12.59	-44.95	-13
Horizontal	5153	-38.32	-46.34	3.23	12.61	-36.96	-13
Horizontal	6870	-54.38	-58.57	3.64	11.50	-50.71	-13
Vertical	3435	-42.02	-55.77	2.52	12.59	-45.71	-13
Vertical	5153	-38.59	-47.28	3.23	12.61	-37.90	-13
Vertical	6870	-56.00	-60.52	3.64	11.50	-52.66	-13
Mid Channel: 20175, Frequency: 1732.5MHz RB/RB Offset: 1@0							
Horizontal	3465	-40.32	-53.47	2.53	12.60	-43.40	-13
Horizontal	5198	-40.80	-49.28	3.11	12.94	-39.45	-13
Horizontal	6930	-55.77	-60.07	3.65	11.50	-52.22	-13
Vertical	3465	-42.47	-56.03	2.53	12.60	-45.96	-13
Vertical	5198	-40.64	-49.61	3.11	12.94	-39.78	-13
Vertical	6930	-56.69	-61.24	3.65	11.50	-53.39	-13
High Channel: 20325, Frequency: 1747.5MHz RB/RB Offset: 1@0							
Horizontal	3495	-36.85	-49.52	2.62	12.60	-39.54	-13
Horizontal	5243	-43.14	-51.70	3.06	13.05	-41.71	-13
Horizontal	6990	-55.53	-59.91	3.83	11.50	-52.24	-13
Vertical	3495	-40.62	-53.88	2.62	12.60	-43.90	-13
Vertical	5243	-40.32	-49.46	3.06	13.05	-39.47	-13
Vertical	6990	-56.83	-61.28	3.83	11.50	-53.61	-13

Note:

1. Receiver setting (Peak Detector) : RBW:1MHz; VBW:3MHz
2. ERP Value = Signal Generator Level + Antenna Gain - Cable Loss
3. Spurious emissions past 8 GHz are not shown, due to the magnitude of spurious emissions attenuated more than 20 dB below the limit.

Product	5G Extender Gen 2		
Test Mode	Spurious Emission (Radiated) - Multi Band Dipole Antenna (STAF)		
Date of Test	2021/06/11	Test Site	Site3
Test Condition	Band 4 (20M) QPSK	Test Range	9kHz ~20GHz

Polarity	Frequency	Reading Level	Signal Generator Level	Cable Loss	Antenna Gain	EIRP Value	Limit
	(GHz)	(dBm)	(dBm)	(dB)	(dBi)	(dBm)	(dBm)
Low Channel: 20050, Frequency: 1720MHz RB/RB Offset: 1@0							
Horizontal	3440	-39.18	-52.67	2.52	12.59	-42.60	-13
Horizontal	5160	-39.38	-47.47	3.21	12.66	-38.02	-13
Horizontal	6880	-53.49	-57.67	3.65	11.50	-49.82	-13
Vertical	3440	-41.36	-55.09	2.52	12.59	-45.02	-13
Vertical	5160	-39.49	-48.22	3.21	12.66	-38.77	-13
Vertical	6880	-54.02	-58.53	3.65	11.50	-50.68	-13
Mid Channel: 20175, Frequency: 1732.5MHz RB/RB Offset: 1@50							
Horizontal	3465	-39.16	-52.07	2.53	12.60	-42.00	-13
Horizontal	5198	-40.07	-48.54	3.11	12.94	-38.71	-13
Horizontal	6930	-53.01	-57.36	3.65	11.50	-49.51	-13
Vertical	3465	-40.57	-54.01	2.53	12.60	-43.94	-13
Vertical	5198	-39.84	-48.74	3.11	12.94	-38.91	-13
Vertical	6930	-54.50	-59.06	3.65	11.50	-51.21	-13
High Channel: 20300, Frequency: 1745MHz RB/RB Offset: 1@0							
Horizontal	3490	-38.58	-51.32	2.61	12.60	-41.33	-13
Horizontal	5235	-42.90	-51.51	3.06	13.06	-41.50	-13
Horizontal	6980	-53.64	-57.90	3.80	11.50	-50.20	-13
Vertical	3490	-40.20	-53.51	2.61	12.60	-43.52	-13
Vertical	5235	-40.60	-49.73	3.06	13.06	-39.72	-13
Vertical	6980	-55.08	-59.56	3.80	11.50	-51.86	-13

Note:

1. Receiver setting (Peak Detector) : RBW:1MHz; VBW:3MHz
2. ERP Value = Signal Generator Level + Antenna Gain - Cable Loss
3. Spurious emissions past 8 GHz are not shown, due to the magnitude of spurious emissions attenuated more than 20 dB below the limit.

Product	5G Extender Gen 2		
Test Mode	Spurious Emission (Radiated) - Multi Band Dipole Antenna (STAF)		
Date of Test	2021/06/11	Test Site	Site3
Test Condition	Band 13 (5M) QPSK	Test Range	9kHz ~25GHz

Polarity	Frequency	Reading Level	Signal Generator Level	Cable Loss	Antenna Gain	EIRP Value	Limit
	(GHz)	(dBm)	(dBm)	(dB)	(dBi)	(dBm)	(dBm)
Low Channel: 23205, Frequency: 779.5MHz RB/RB Offset: 1@12							
Horizontal	1559	-50.75	-67.53	1.73	9.97	-59.29	-40
Horizontal	2339	-42.41	-57.70	2.65	12.06	-48.30	-13
Horizontal	3118	-52.12	-66.64	2.43	12.44	-56.63	-13
Vertical	1559	-50.64	-68.18	1.73	9.97	-59.94	-40
Vertical	2339	-40.93	-55.93	2.65	12.06	-46.53	-13
Vertical	3118	-50.30	-63.63	2.43	12.44	-53.62	-13
Mid Channel: 23230, Frequency: 782MHz RB/RB Offset: 1@12							
Horizontal	1564	-51.58	-68.45	1.73	9.98	-60.21	-40
Horizontal	2346	-45.62	-60.86	2.67	12.11	-51.43	-13
Horizontal	3128	-50.86	-65.26	2.44	12.44	-55.25	-13
Vertical	1564	-50.99	-68.60	1.73	9.98	-60.36	-40
Vertical	2346	-44.05	-58.93	2.67	12.11	-49.50	-13
Vertical	3128	-51.57	-64.96	2.44	12.44	-54.95	-13
High Channel: 23255, Frequency: 784.5MHz RB/RB Offset: 1@12							
Horizontal	1569	-51.18	-68.29	1.74	9.98	-60.04	-40
Horizontal	2354	-43.33	-58.53	2.69	12.16	-49.07	-13
Horizontal	3138	-51.80	-66.15	2.44	12.45	-56.14	-13
Vertical	1569	-51.47	-69.12	1.74	9.98	-60.87	-40
Vertical	2354	-42.57	-57.33	2.69	12.16	-47.87	-13
Vertical	3138	-51.83	-65.35	2.44	12.45	-55.34	-13

Note:

1. Receiver setting (Peak Detector) : RBW:1MHz; VBW:3MHz
2. ERP Value = Signal Generator Level + Antenna Gain - Cable Loss
3. Spurious emissions past 10 GHz are not shown, due to the magnitude of spurious emissions attenuated more than 20 dB below the limit.

Product	5G Extender Gen 2		
Test Mode	Spurious Emission (Radiated) - Multi Band Dipole Antenna (STAF)		
Date of Test	2021/06/11	Test Site	Site3
Test Condition	Band 13 (10M) QPSK	Test Range	9kHz ~25GHz

Polarity	Frequency	Reading Level	Signal Generator Level	Cable Loss	Antenna Gain	EIRP Value	Limit
	(GHz)	(dBm)	(dBm)	(dB)	(dBi)	(dBm)	(dBm)
Mid Channel: 23230, Frequency: 782MHz RB/RB Offset: 1@25							
Horizontal	1564	-51.12	-68.07	1.73	9.98	-59.83	-40
Horizontal	2346	-45.71	-60.95	2.67	12.11	-51.52	-13
Horizontal	3128	-51.54	-65.95	2.44	12.44	-55.94	-13
Vertical	1564	-51.65	-69.28	1.73	9.98	-61.04	-40
Vertical	2346	-43.99	-58.87	2.67	12.11	-49.44	-13
Vertical	3128	-51.86	-65.31	2.44	12.44	-55.30	-13

Note:

1. Receiver setting (Peak Detector) : RBW:1MHz; VBW:3MHz
2. ERP Value = Signal Generator Level + Antenna Gain - Cable Loss
3. Spurious emissions past 10 GHz are not shown, due to the magnitude of spurious emissions attenuated more than 20 dB below the limit.

7. Frequency Stability Under Temperature & Voltage Variations

7.1. Test Specification

According to Part 2.1055, 27.54

7.2. Test Setup

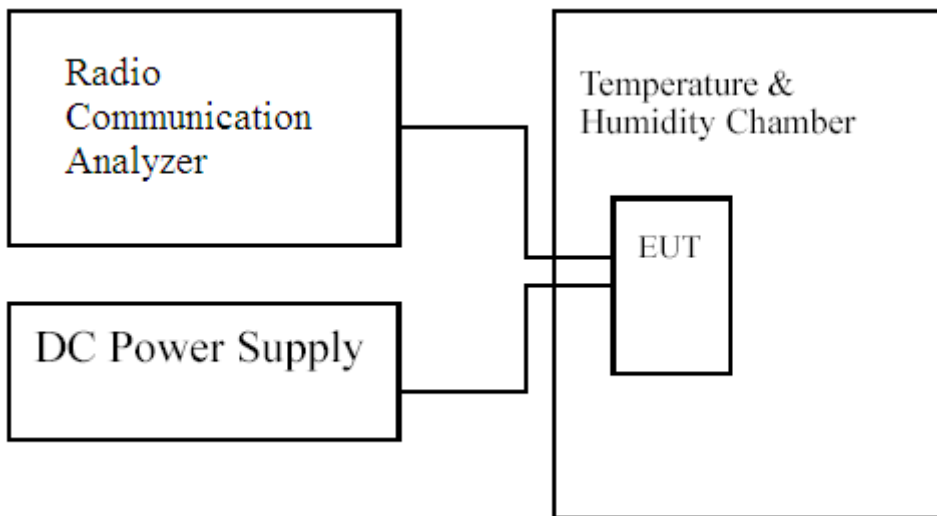

7.3. Limits

Limit	$<\pm 2.5\text{ppm}$
-------	----------------------

7.4. Test Procedure

The frequency stability of transmitter is measured by:

- (a) Temperature: The temperature is varied from -30°C to 50°C in 10°C increment using a standard temperature & Humidity chamber.
- (b) Primary Supply Voltage: The primary supply voltage is varied 85% to 115% of the nominal value for non hand-carried equipment. For hand-carried, battery-powered equipment, primary supply voltage is reduced to the battery operating endpoint which shall be specified by the manufacturer.

The EUT was connected via the base station simulator. Universal Radio Communication Tester, was used to measure The Frequency Error. The maximum result of measurements was recorded.

7.5. Test Result of Frequency Stability Under Temperature Variations

Product	5G Extender Gen 2		
Test Mode	Frequency Stability Under Temperature Variations & Voltage Variations		
Date of Test	2021/06/09	Test Site	CTR
Test Condition	Band 4 CH20175(1732.5MHz) –QPSK	Test Range	-30°C~+50°C

Frequency Stability Under Temperature Variations

Temperature Interval(°C)	Test Channel	Deviation (kHz)						Limit (kHz)
		1.4M	3M	5M	10M	15M	20M	
-30	Mid	0.0078	0.0057	0.0061	0.0056	0.0063	0.0047	±4.28
-20	Mid	0.0042	-0.0047	0.0062	0.0047	0.0079	0.0048	±4.28
-10	Mid	0.0051	0.0073	0.0060	0.0049	0.0062	0.0094	±4.28
0	Mid	0.0086	0.0094	0.0070	0.0047	0.0053	0.0076	±4.28
10	Mid	0.0057	0.0049	0.0096	0.0057	0.0038	0.0063	±4.28
20	Mid	0.0061	-0.0076	0.0045	-0.0044	0.0059	0.0054	±4.28
30	Mid	-0.0060	0.0064	0.0044	0.0067	0.0066	-0.0042	±4.28
40	Mid	0.0048	0.0058	0.0059	0.0040	0.0067	0.0043	±4.28
50	Mid	-0.0061	0.0053	-0.0036	0.0069	0.0067	-0.0055	±4.28

Voltage Variations

DC Voltage (V)	Test Channel	Deviation (kHz)						Limit (kHz)
		1.4M	3M	5M	10M	15M	20M	
138	Mid	0.0044	-0.0045	-0.0053	0.0059	0.0053	0.0044	±4.28
120	Mid	0.0061	0.0076	0.0045	-0.0044	0.0059	0.0054	±4.28
102	Mid	0.0076	0.0054	0.0045	0.0046	0.0044	0.0042	±4.28

DC Current (A)	1.4M	3M	5M	10M	15M	20M
LINK:	0.12	0.11	0.11	0.12	0.13	0.11
IDLE:	0.08	0.09	0.07	0.08	0.09	0.09

Product	5G Extender Gen 2		
Test Mode	Frequency Stability Under Temperature Variations & Voltage Variations		
Date of Test	2021/06/09	Test Site	CTR
Test Condition	Band 13 CH23230(782MHz) –QPSK	Test Range	-30°C~+50°C

Frequency Stability Under Temperature Variations

Temperature Interval(°C)	Test Channel	Deviation (kHz)						Limit (kHz)
		1.4M	3M	5M	10M	15M	20M	
-30	Mid	--	--	0.0053	-0.0035	--	--	±1.94
-20	Mid	--	--	0.0036	-0.0047	--	--	±1.94
-10	Mid	--	--	0.0050	0.0043	--	--	±1.94
0	Mid	--	--	0.0035	-0.0026	--	--	±1.94
10	Mid	--	--	-0.0040	-0.0044	--	--	±1.94
20	Mid	--	--	-0.0026	-0.0042	--	--	±1.94
30	Mid	--	--	-0.0048	-0.0051	--	--	±1.94
40	Mid	--	--	-0.0028	0.0054	--	--	±1.94
50	Mid	--	--	-0.0030	-0.0032	--	--	±1.94

Voltage Variations

DC Voltage (V)	Test Channel	Deviation (kHz)						Limit (kHz)
		1.4M	3M	5M	10M	15M	20M	
138	Mid	--	--	0.0035	0.0058	--	--	±1.94
120	Mid	--	--	-0.0026	-0.0042	--	--	±1.94
102	Mid	--	--	0.0038	-0.0032	--	--	±1.94

DC Current (A)	5M	10M
LINK:	0.12	0.11
IDLE:	0.09	0.08

8. Peak to Average Ratio

8.1 Test Specification

According to Part 27.50

8.1. Test Setup

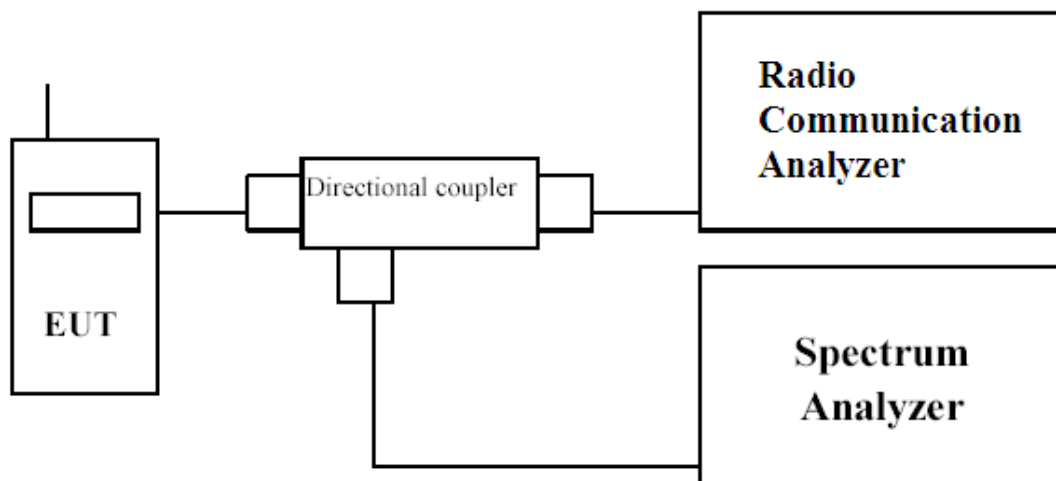

8.2. Limits

The peak-to-average power ratio (PAPR) of the transmitter output power must not exceed 13 dB. The PAPR measurements should be made using either an instrument with complementary cumulative distribution function (CCDF) capabilities to determine that PAPR will not exceed 13 dB for more than 0.1 percent of the time or other Commission approved procedure.

8.3. Test Procedure

- a) Refer to instrument's analyzer instruction manual for details on how to use the power statistics/CCDF function;
- b) Set resolution/measurement bandwidth \geq signal's occupied bandwidth;
- c) Set the number of counts to a value that stabilizes the measured CCDF curve;
- d) Set the measurement interval as follows:
 - 1) for continuous transmissions, set to 1 ms,
 - 2) for burst transmissions, employ an external trigger that is synchronized with the EUT burst timing sequence, or use the internal burst trigger with a trigger level that allows the burst to stabilize and set the measurement interval to a time that is less than or equal to the burst duration.
- e) Record the maximum PAPR level associated with a probability of 0.1%.

8.4. Test Result of Spurious Emission

Product	5G Extender Gen 2		
Test Mode	Peak to Average Ratio		
Date of Test	2021/06/05	Test Site	CTR
Test Condition	LTE-Band 4 QPSK/16QAM		

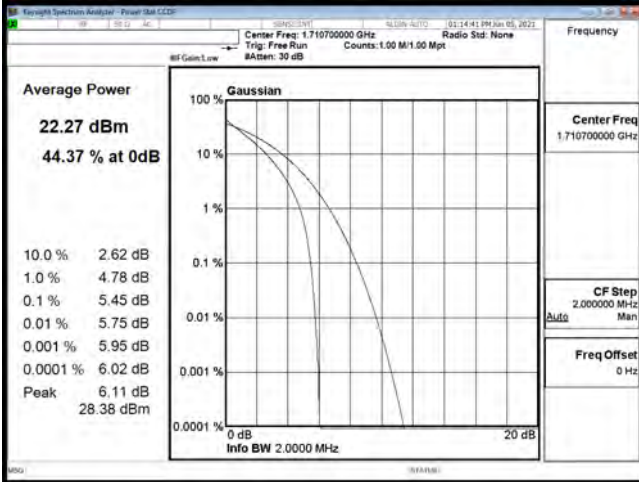

PTAR B4 1.4M CH19957 QPSK

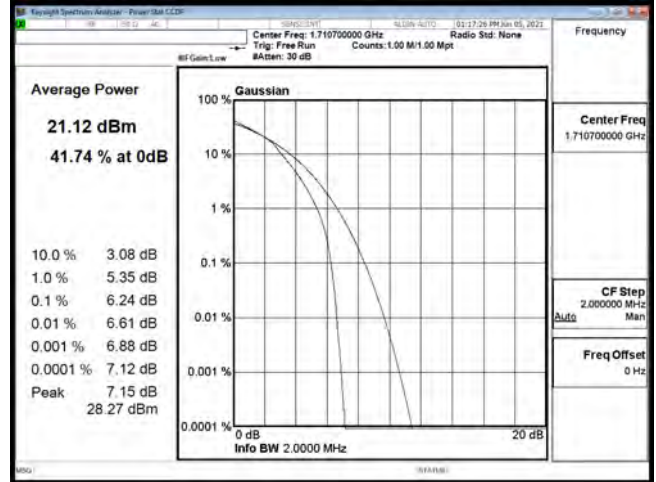

PTAR B4 1.4M CH19957 16QAM

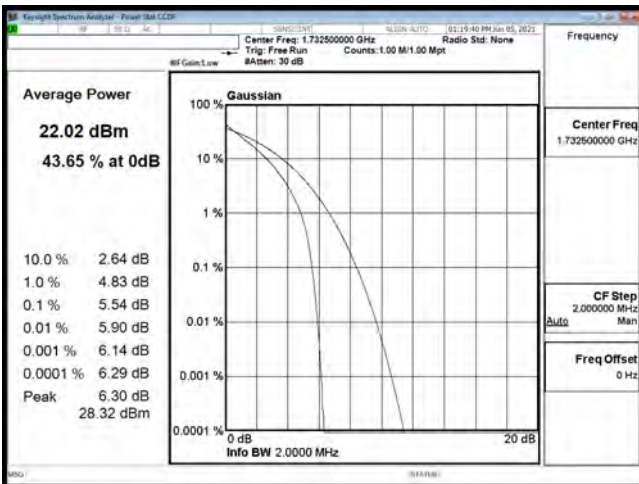

PTAR B4 1.4M CH20175 QPSK

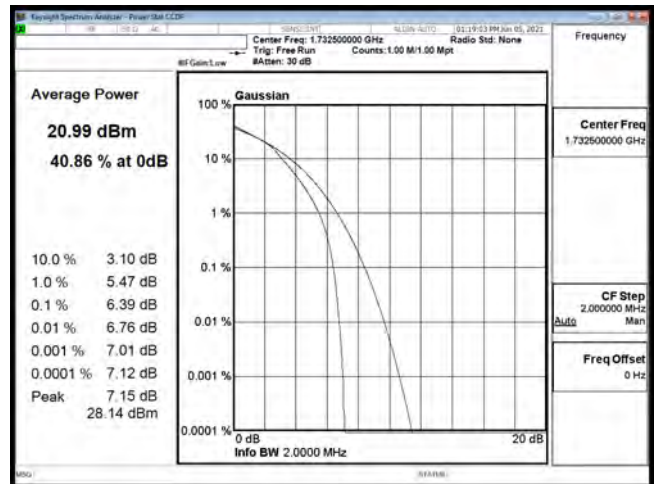

PTAR B4 1.4M CH20175 16QAM

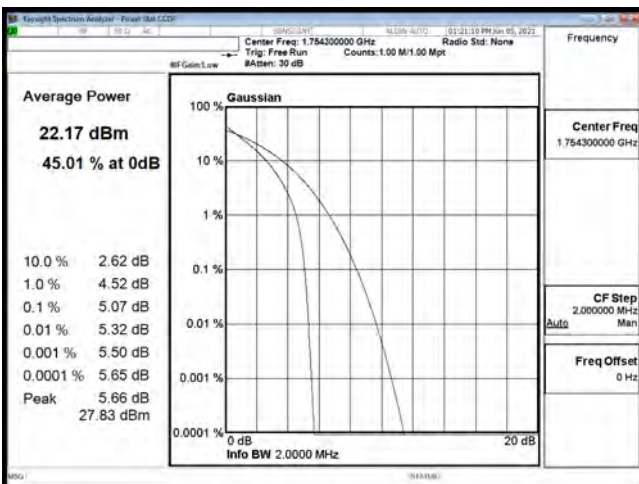

PTAR B4 1.4M CH20393 QPSK

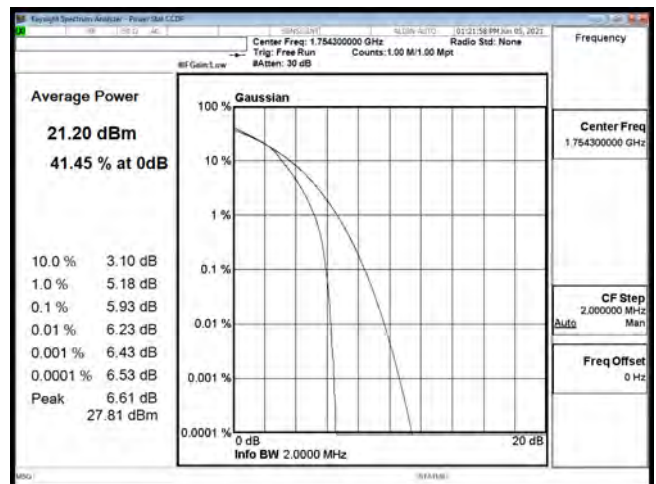

PTAR B4 1.4M CH20393 16QAM

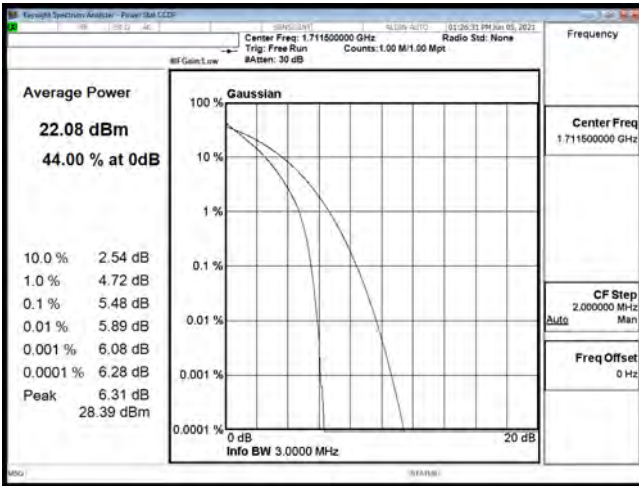

PTAR B4 3M CH19965 QPSK

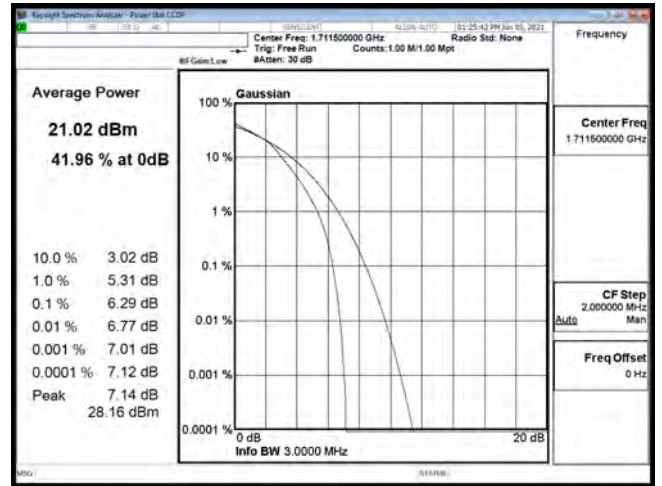

PTAR B4 3M CH19965 16QAM

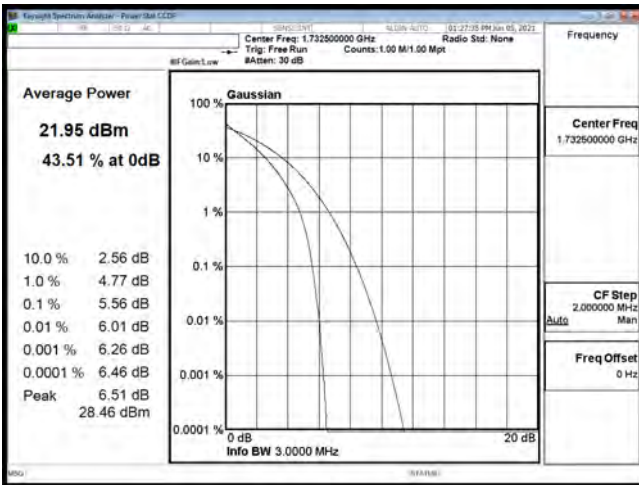

PTAR B4 3M CH20175 QPSK

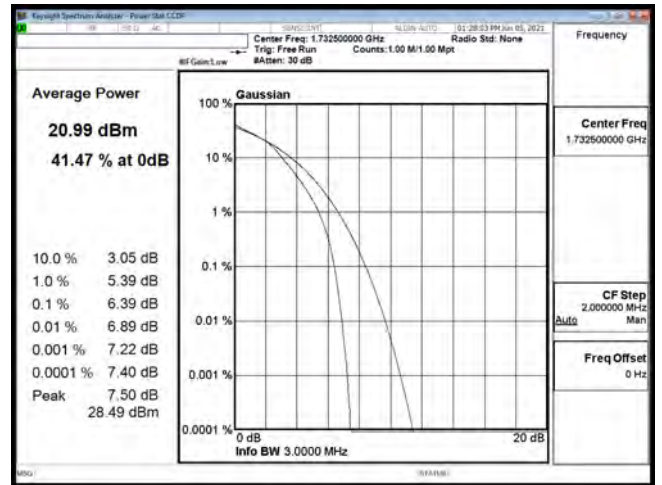

PTAR B4 3M CH20175 16QAM

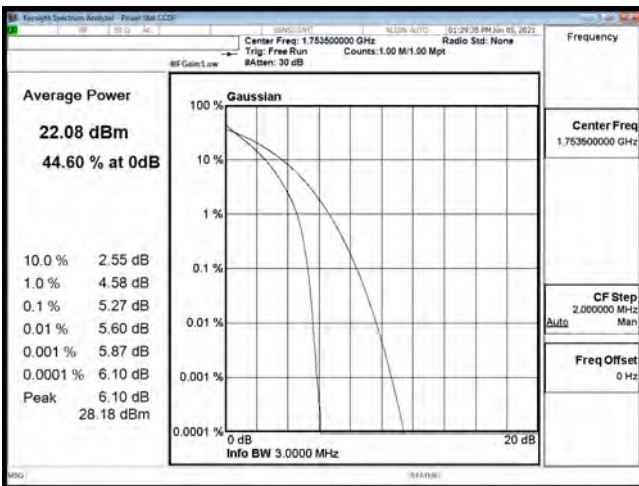

PTAR B4 3M CH20385 QPSK

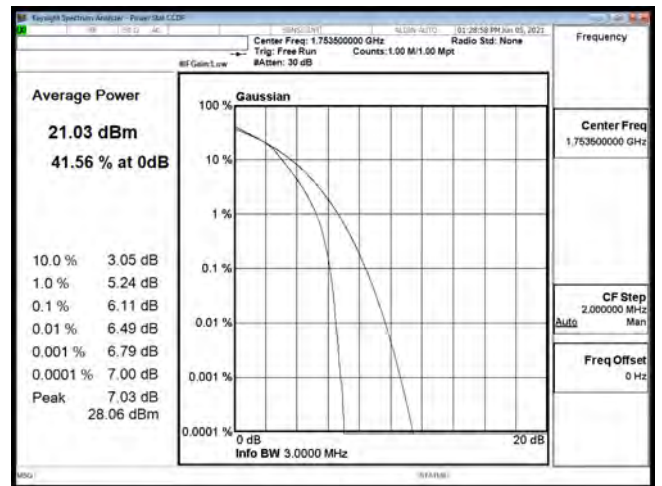

PTAR B4 3M CH20385 16QAM

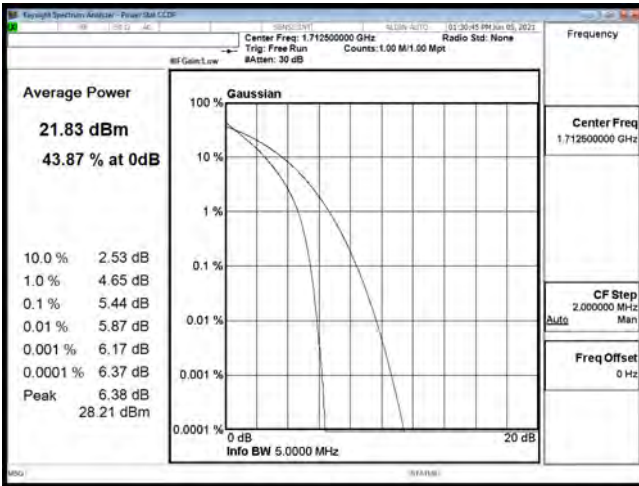

PTAR B4 5M CH19975 QPSK

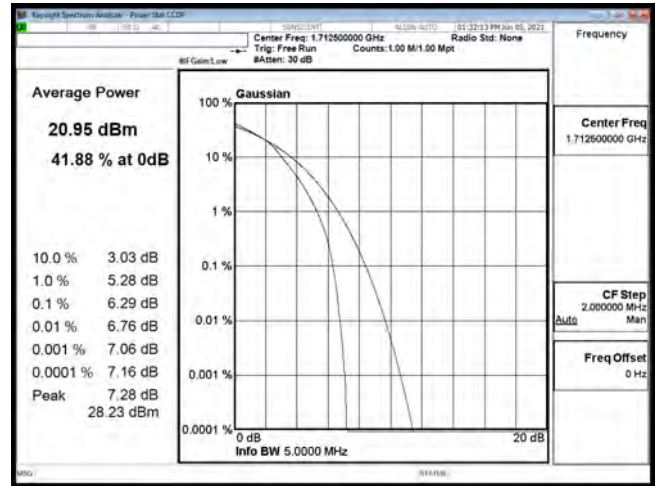

PTAR B4 5M CH19975 16QAM

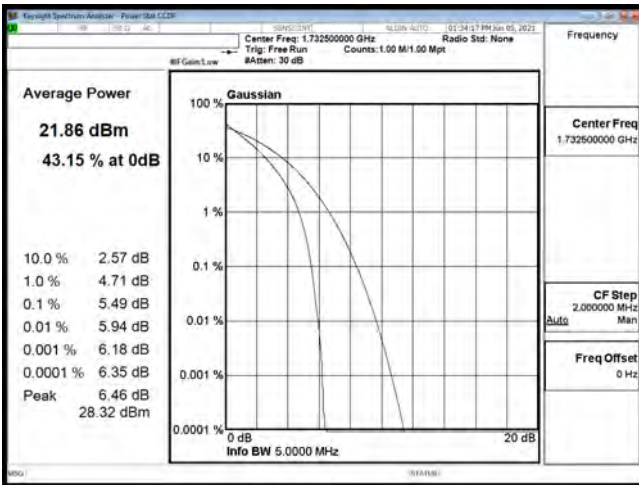

PTAR B4 5M CH20175 QPSK

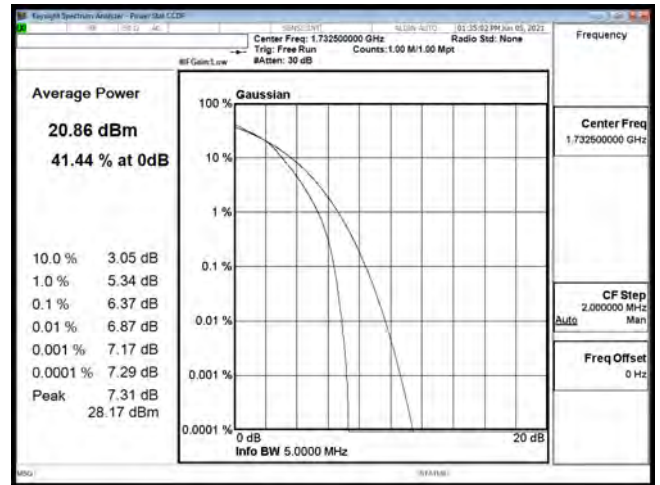

PTAR B4 5M CH20175 16QAM

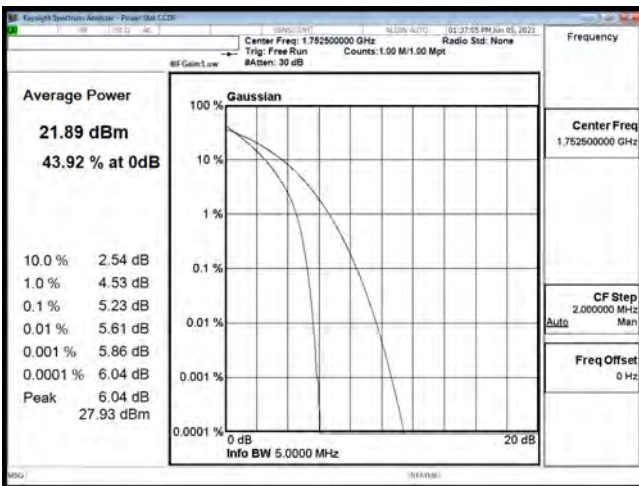

PTAR B4 5M CH20375 QPSK

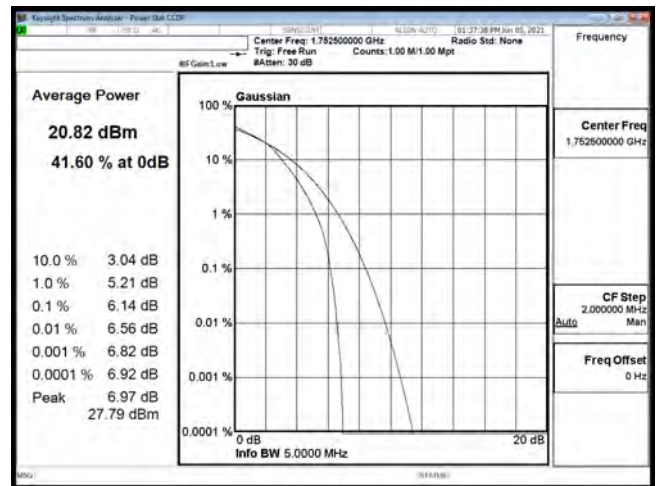

PTAR B4 5M CH20375 16QAM

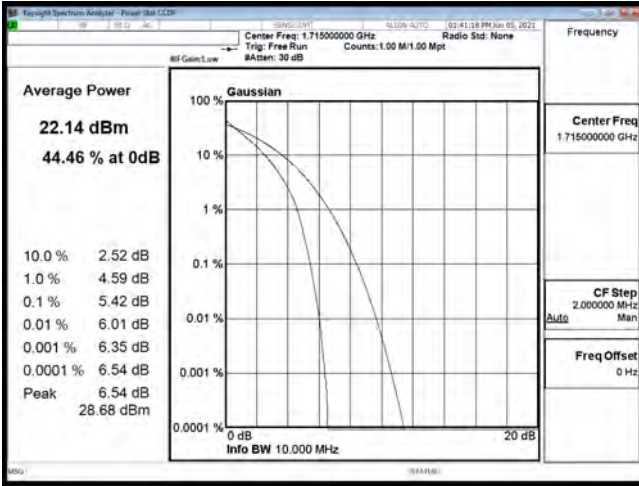

PTAR B4 10M CH20000 QPSK

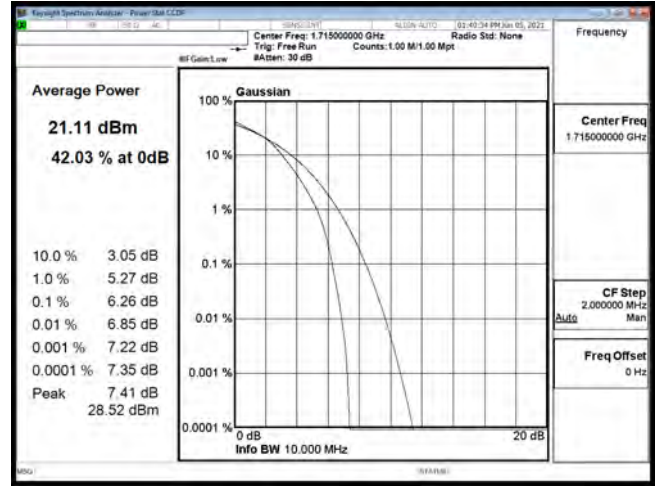

PTAR B4 10M CH20000 16QAM

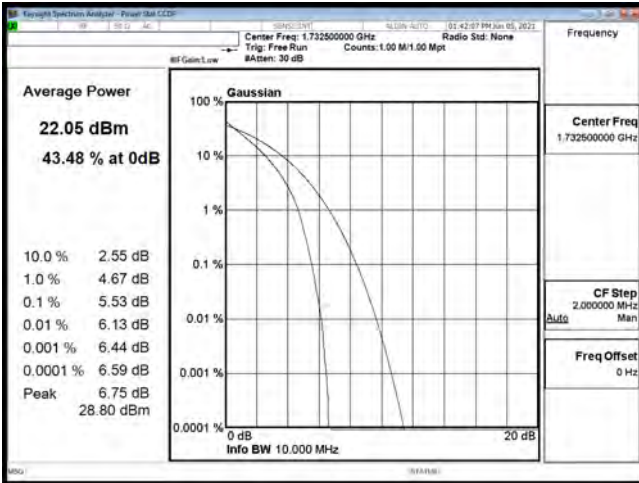

PTAR B4 10M CH20175 QPSK

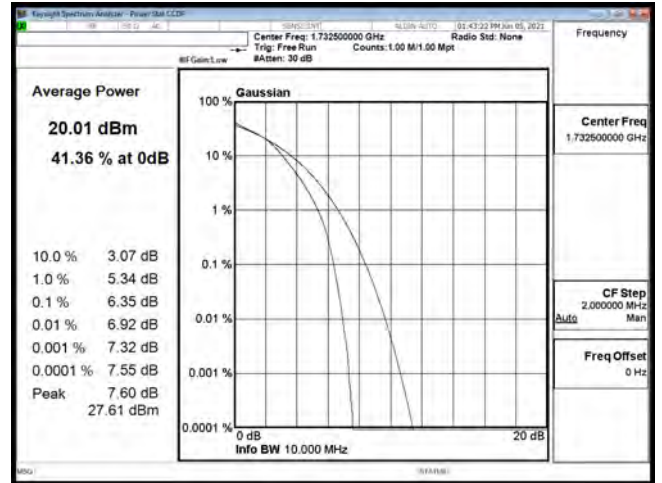

PTAR B4 10M CH20175 16QAM

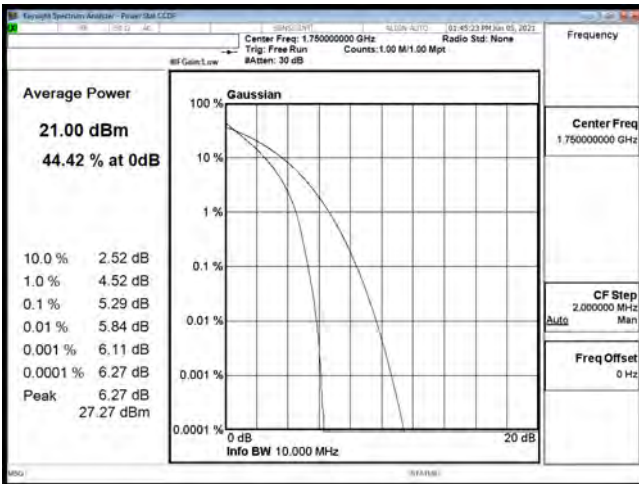

PTAR B4 10M CH20350 QPSK

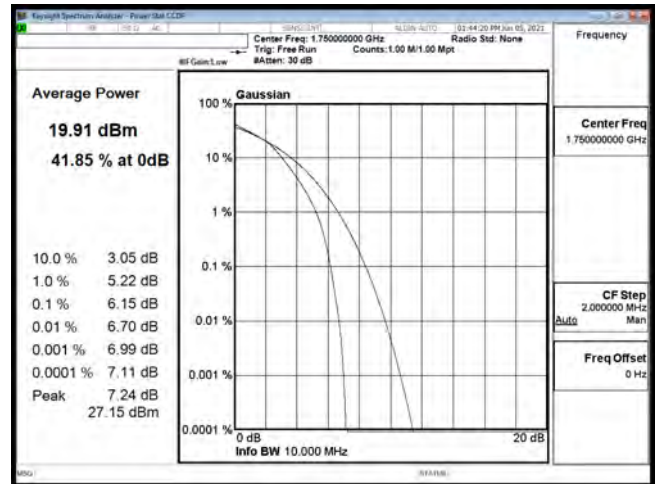

PTAR B4 10M CH20350 16QAM

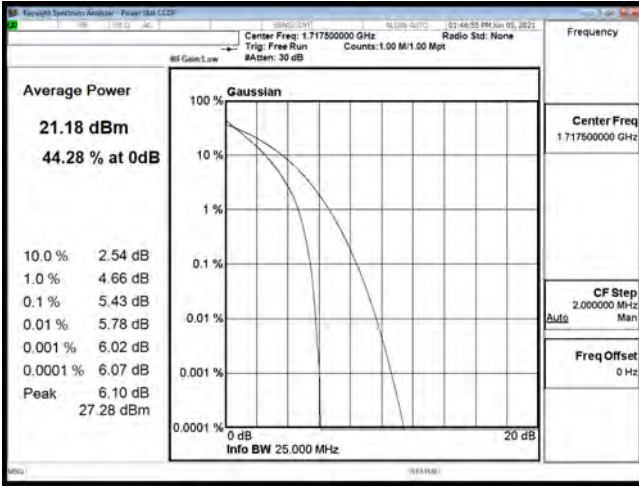

PTAR B4 15M CH20025 QPSK

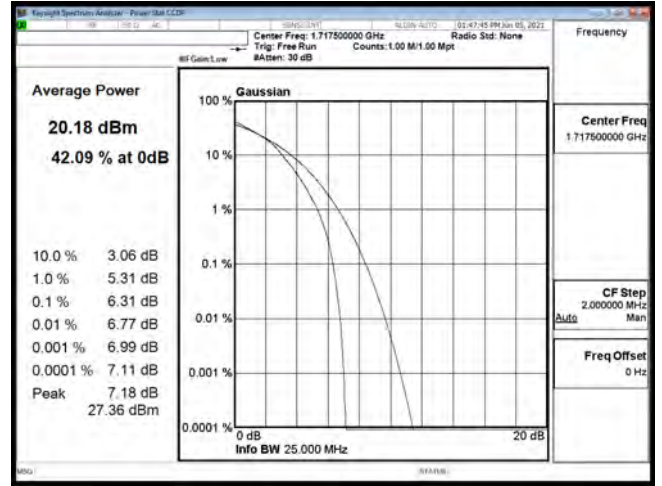

PTAR B4 15M CH20025 16QAM

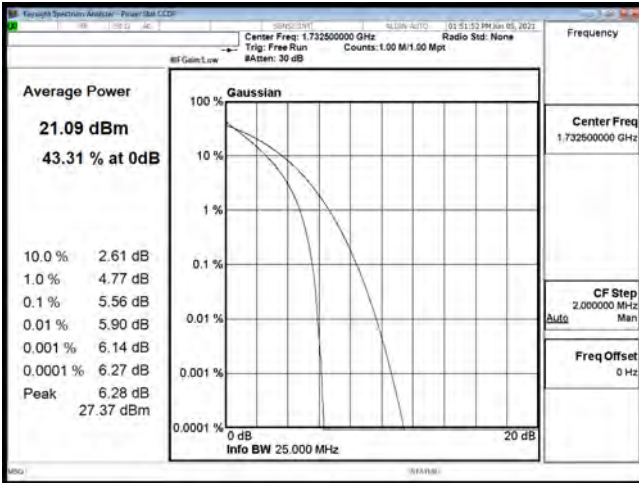

PTAR B4 15M CH20175 QPSK

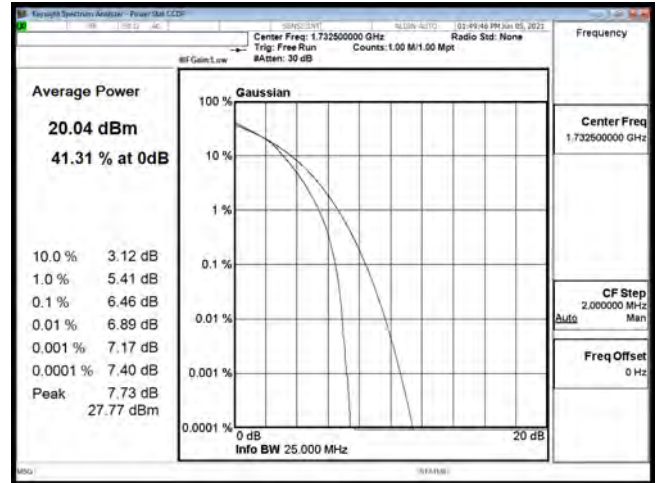

PTAR B4 15M CH20175 16QAM

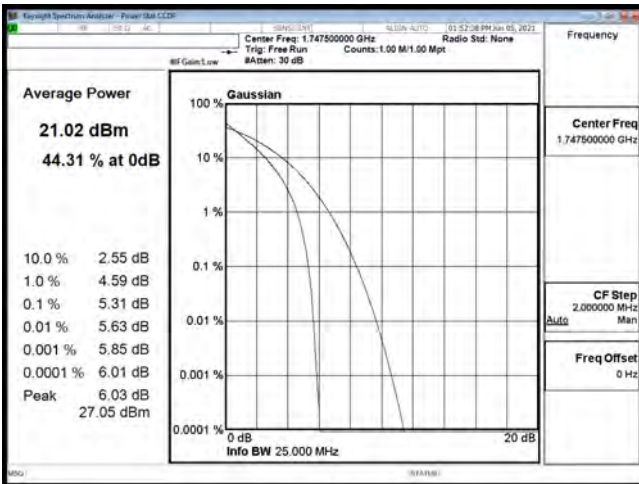

PTAR B4 15M CH20325 QPSK

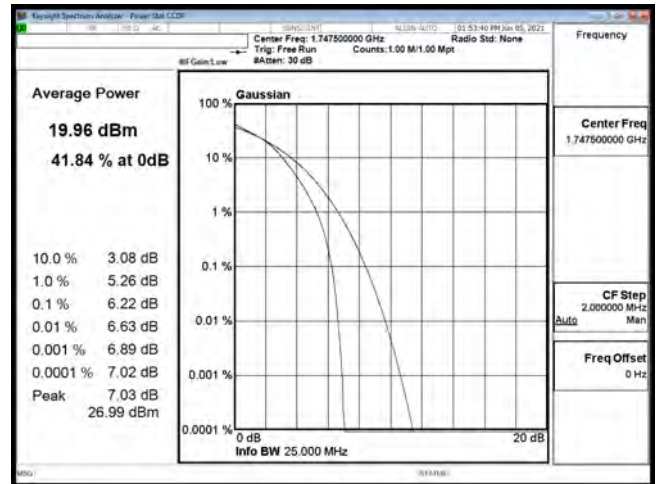

PTAR B4 15M CH20325 16QAM

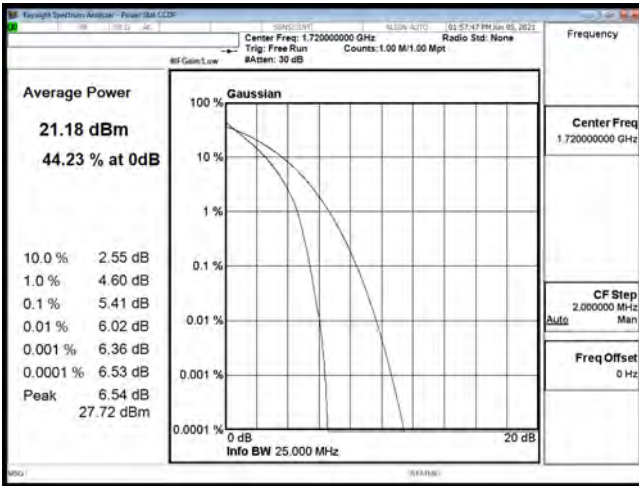

PTAR B4 20M CH20050 QPSK

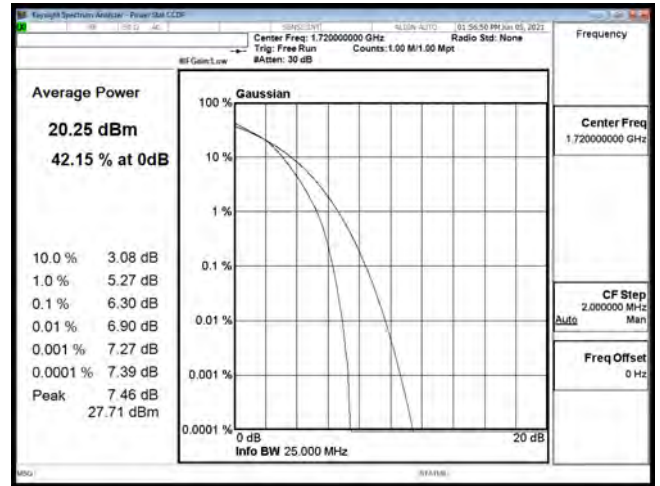

PTAR B4 20M CH20050 16QAM

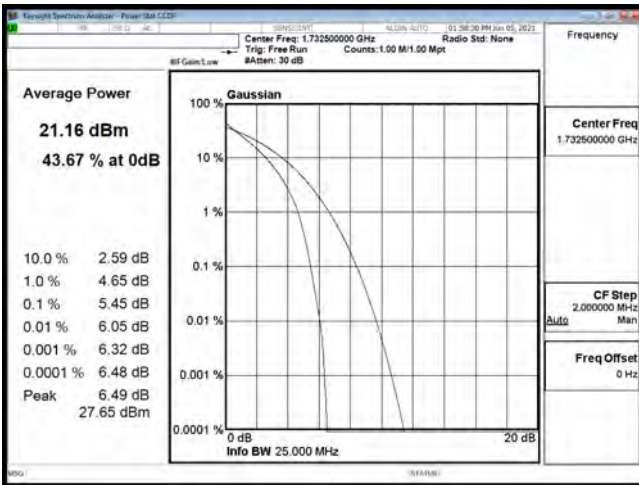

PTAR B4 20M CH20175 QPSK

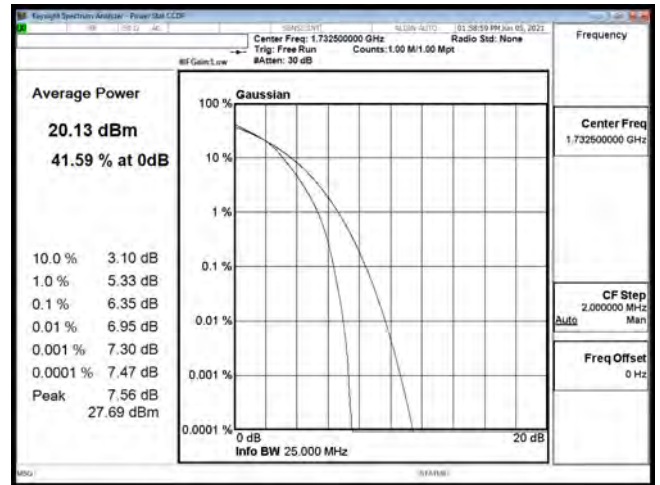

PTAR B4 20M CH20175 16QAM

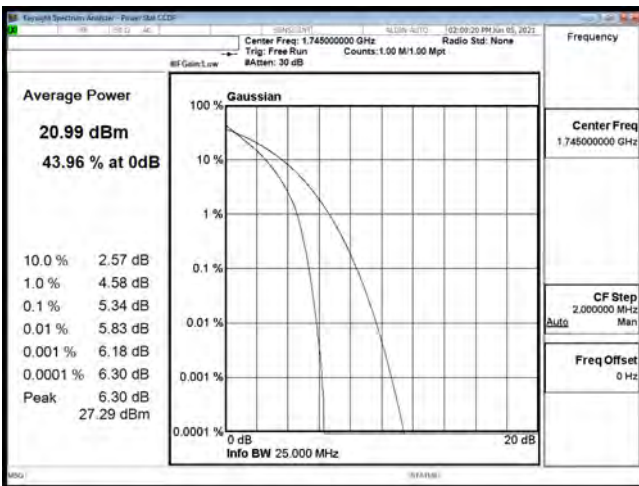

PTAR B4 20M CH20300 QPSK

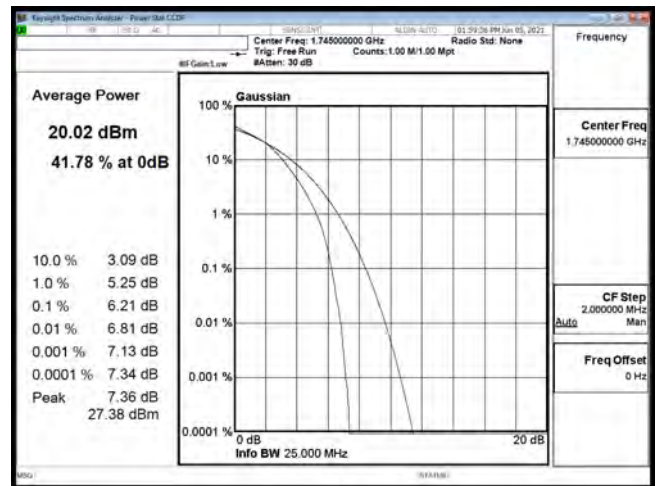

PTAR B4 20M CH20300 16QAM

Product	5G Extender Gen 2		
Test Mode	Peak to Average Ratio		
Date of Test	2021/06/08	Test Site	CTR
Test Condition	LTE-Band 13 QPSK/16QAM		

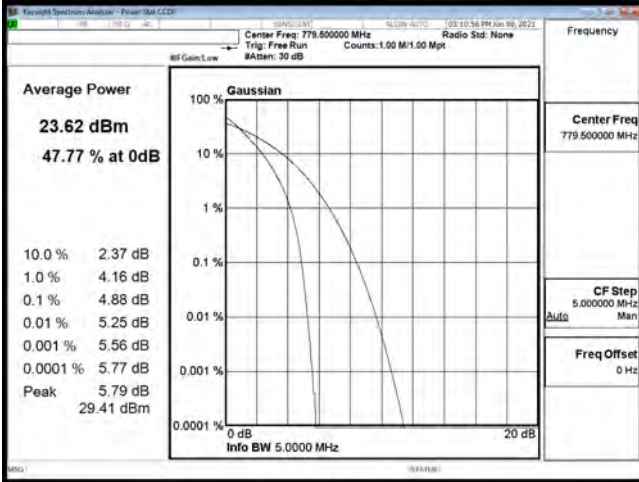

PTAR B13 5M CH23205 QPSK

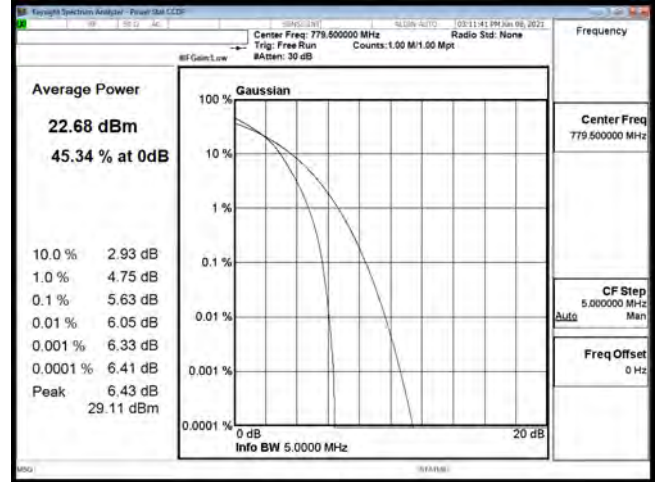

PTAR B13 5M CH23205 16QAM

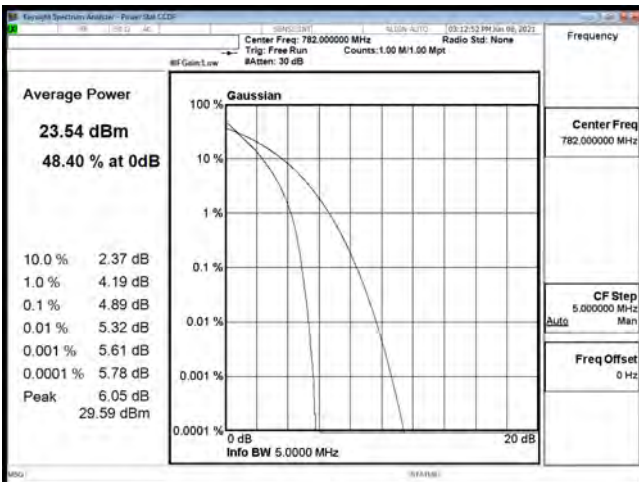

PTAR B13 5M CH23230 QPSK

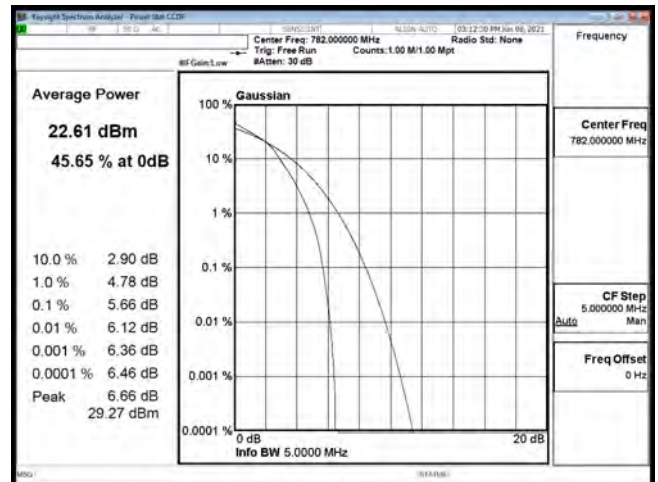

PTAR B13 5M CH23230 16QAM

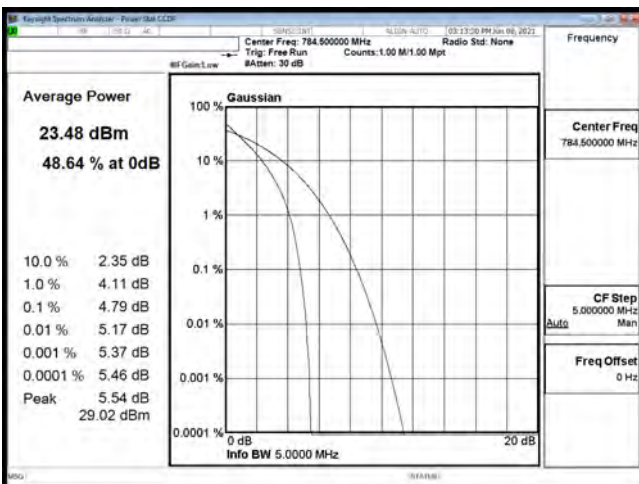

PTAR B13 5M CH23255 QPSK

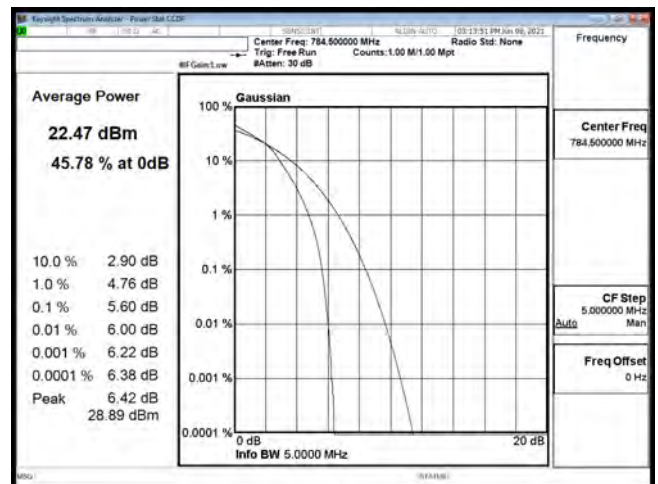

PTAR B13 5M CH23255 16QAM

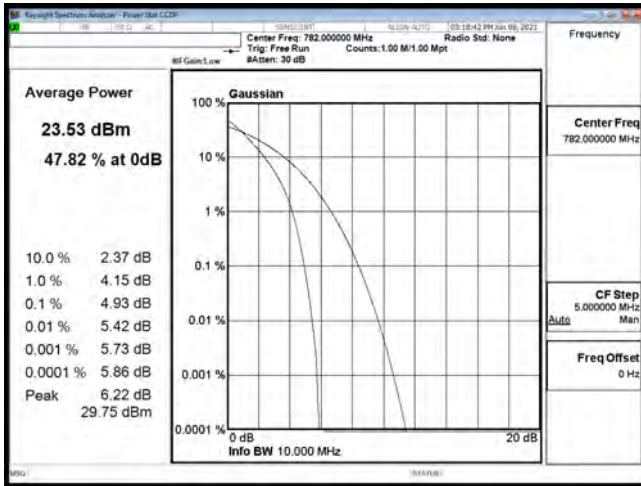

PTAR B13 10M CH23230 QPSK

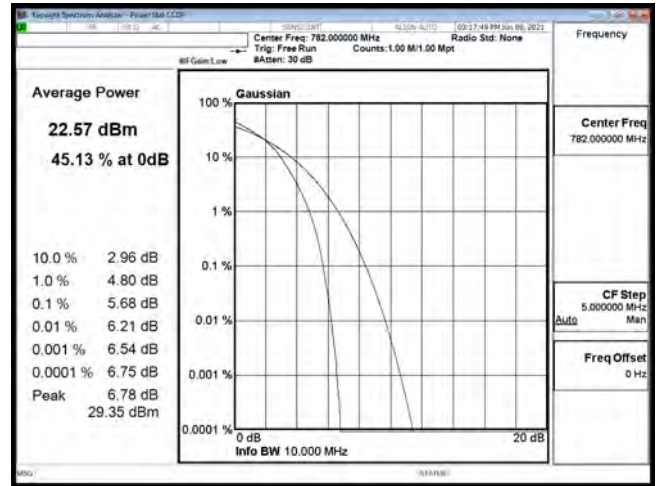

PTAR B13 10M CH23230 16QAM