

FCC Test Report

(PART 22)

Report No.: RF181126C15B

FCC ID: N7NHL78

Test Model: HL7800

Received Date: Jun. 02, 2020

Test Date: Jun. 02 ~ Jun. 12, 2020

Issued Date: Jul. 09, 2020

Applicant: Sierra Wireless Inc.

Address: 13811 Wireless Way, Richmond, BC, Canada V6V3A4

Issued By: Bureau Veritas Consumer Products Services (H.K.) Ltd., Taoyuan Branch
Lin Kou Laboratories

Lab Address: No. 47-2, 14th Ling, Chia Pau Vil., Lin Kou Dist., New Taipei City, Taiwan

Test Location: No.19, Hwa Ya 2nd Rd., Wen Hwa Vil., Kwei Shan Dist., Taoyuan City
33383, Taiwan

**FCC Registration /
Designation Number:** 788550 / TW0003



This report is for your exclusive use. Any copying or replication of this report to or for any other person or entity, or use of our name or trademark, is permitted only with our prior written permission. This report sets forth our findings solely with respect to the test samples identified herein. The results set forth in this report are not indicative or representative of the quality or characteristics of the lot from which a test sample was taken or any similar or identical product unless specifically and expressly noted. Our report includes all of the tests requested by you and the results thereof based upon the information that you provided to us. You have 60 days from date of issuance of this report to notify us of any material error or omission caused by our negligence, provided, however, that such notice shall be in writing and shall specifically address the issue you wish to raise. A failure to raise such issue within the prescribed time shall constitute your unqualified acceptance of the completeness of this report, the tests conducted and the correctness of the report contents. Unless specific mention, the uncertainty of measurement has been explicitly taken into account to declare the compliance or non-compliance to the specification. This report should not be used by the client to claim any endorsement by TAF.

Table of Contents

Release Control Record	4
1 Certificate of Conformity	5
2 Summary of Test Results	6
2.1 Measurement Uncertainty	6
2.2 Test Site and Instruments	7
3 General Information	8
3.1 General Description of EUT	8
3.2 Configuration of System under Test	10
3.2.1 Description of Support Units	10
3.3 Test Mode Applicability and Tested Channel Detail	11
3.4 EUT Operating Conditions	16
3.5 General Description of Applied Standards	16
4 Test Types and Results	17
4.1 Output Power Measurement	17
4.1.1 Limits of Output Power Measurement	17
4.1.2 Test Procedures	17
4.1.3 Test Setup	18
4.1.4 Test Results	19
4.2 Modulation Characteristics Measurement	42
4.2.1 Limits of Modulation Characteristics	42
4.2.2 Test Setup	42
4.2.3 Test Procedure	42
4.2.4 Test Results	43
4.3 Frequency Stability Measurement	45
4.3.1 Limits of Frequency Stability Measurement	45
4.3.2 Test Procedure	45
4.3.3 Test Setup	45
4.3.4 Test Results	46
4.4 Occupied Bandwidth Measurement	57
4.4.1 Test Procedure	57
4.4.2 Test Setup	57
4.4.3 Test Result	58
4.5 Band Edge Measurement	65
4.5.1 Limits of Band Edge Measurement	65
4.5.2 Test Setup	65
4.5.3 Test Procedures	65
4.5.4 Test Results	66
4.6 Peak to Average Ratio	79
4.6.1 Limits of Peak to Average Ratio Measurement	79
4.6.2 Test Setup	79
4.6.3 Test Procedures	79
4.6.4 Test Results	80
4.7 Conducted Spurious Emissions	87
4.7.1 Limits of Conducted Spurious Emissions Measurement	87
4.7.2 Test Setup	87
4.7.3 Test Procedure	87
4.7.4 Test Results	88
4.8 Radiated Emission Measurement	99
4.8.1 Limits of Radiated Emission Measurement	99
4.8.2 Test Procedure	99
4.8.3 Deviation from Test Standard	99
4.8.4 Test Setup	100
4.8.5 Test Results	101

5 Pictures of Test Arrangements.....	149
Appendix – Information of the Testing Laboratories	150

Release Control Record

Issue No.	Description	Date Issued
RF181126C15B	Original Release	Jul. 09, 2020

1 Certificate of Conformity

Product: Embedded Module
Brand: AirPrime
Test Model: HL7800
Sample Status: Engineering Sample
Applicant: Sierra Wireless Inc.
Test Date: Jun. 02 ~ Jun. 12, 2020
Standards: FCC Part 22, Subpart H

The above equipment has been tested by **Bureau Veritas Consumer Products Services (H.K.) Ltd., Taoyuan Branch**, and found compliance with the requirement of the above standards. The test record, data evaluation & Equipment Under Test (EUT) configurations represented herein are true and accurate accounts of the measurements of the sample's RF characteristics under the conditions specified in this report.

Prepared by : Gina Liu, **Date:** Jul. 09, 2020
Gina Liu / Specialist

Approved by : Dylan Chiou, **Date:** Jul. 09, 2020
Dylan Chiou / Senior Project Engineer

2 Summary of Test Results

Applied Standard: FCC Part 22 & Part 2			
FCC Clause	Test Item	Result	Remarks
2.1046 22.913 (a)	Effective Radiated Power	Pass	Meet the requirement of limit.
2.1047	Modulation Characteristics	Pass	Meet the requirement.
22.913 (d)	Peak to Average Ratio	Pass	Meet the requirement of limit.
2.1055 22.355	Frequency Stability	Pass	Meet the requirement of limit.
2.1049	Occupied Bandwidth	Pass	Meet the requirement of limit.
22.917	Band Edge Measurements	Pass	Meet the requirement of limit.
2.1051 22.917	Conducted Spurious Emissions	Pass	Meet the requirement of limit.
2.1053 22.917	Radiated Spurious Emissions	Pass	Meet the requirement of limit. Minimum passing margin is -30.62 dB at 2539.50 MHz.

Note: Determining compliance based on the results of the compliance measurement, not taking into account measurement instrumentation uncertainty.

2.1 Measurement Uncertainty

Where relevant, the following measurement uncertainty levels have been estimated for tests performed on the EUT as specified in CISPR 16-4-2:

Measurement	Frequency	Expanded Uncertainty (k=2) (±)
Radiated Emissions up to 1 GHz	9 kHz ~ 30 MHz	3.04 dB
	30 MHz ~ 200 MHz	2.93 dB
	200 MHz ~ 1000 MHz	2.95 dB
Radiated Emissions above 1 GHz	1 GHz ~ 18 GHz	2.26 dB
	18 GHz ~ 40 GHz	1.94 dB

2.2 Test Site and Instruments

Description & Manufacturer	Model No.	Serial No.	Date of Calibration	Due Date of Calibration
Test Receiver Agilent	N9038A	MY51210203	Mar. 18, 2020	Mar. 17, 2021
Spectrum Analyzer Agilent	N9010A	MY52220314	Dec. 12, 2019	Dec. 11, 2020
Spectrum Analyzer ROHDE & SCHWARZ	FSU43	101261	Apr. 16, 2020	Apr. 15, 2021
HORN Antenna SCHWARZBECK	BBHA 9120D	9120D-969	Nov. 24, 2019	Nov. 23, 2020
BILOG Antenna SCHWARZBECK	VULB 9168	9168-160	Nov. 07, 2019	Nov. 06, 2020
BILOG Antenna SCHWARZBECK	VULB 9168	9168-472	Nov. 08, 2019	Nov. 07, 2020
Fixed Attenuator Mini-Circuits	MDCS18N-10	MDCS18N-10-01	Apr. 14, 2020	Apr. 13, 2021
MXG Vector signal generator Agilent	N5182B	MY53050430	Oct. 25, 2019	Oct. 24, 2020
Preamplifier EMCI	EMC 012645	980115	Oct. 08, 2019	Oct. 07, 2020
Preamplifier EMCI	EMC 330H	980112	Oct. 08, 2019	Oct. 07, 2020
RF Coaxial Cable HUBER+SUHNNER	EMC104-SM-SM-800 0&3000	140811+170717	Oct. 08, 2019	Oct. 07, 2020
RF Coaxial Cable HUBER+SUHNNER	SUCOFLEX 104	EMC104-SM-SM-1 000(140807)	Oct. 08, 2019	Oct. 07, 2020
RF Coaxial Cable WOKEN	8D-FB	Cable-Ch10-01	Oct. 08, 2019	Oct. 07, 2020
Boresight Antenna Fixture	FBA-01	FBA-SIP01	NA	NA
Software BV ADT	E3 6.120103	NA	NA	NA
Antenna Tower MF	MFA-440H	NA	NA	NA
Turn Table MF	MFT-201SS	NA	NA	NA
Antenna Tower & Turn Table Controller MF	MF-7802	NA	NA	NA
Radio Communication Analyzer Anritsu	MT8821C	6261806803	Jan. 18, 2020	Jan. 17, 2021
Spectrum Analyzer R&S	FSW43	101582	Mar. 31, 2020	Mar. 30 2021
Temperature & Humidity Chamber	GTH-120-40-CP-AR	MAA1306-019	Sep. 10, 2019	Sep. 09, 2020
DC Power Supply Topward	33010D	807748	NA	NA
Digital Multimeter Fluke	87-III	70360742	Jun. 27, 2019 Jun. 23, 2020	Jun. 26, 2020 Jun. 22, 2021

Note: 1. The calibration interval of the above test instruments is 12 months and the calibrations are traceable to NML/ROC and NIST/USA.

2. The test was performed in HwaYa Chamber 10.

3 General Information

3.1 General Description of EUT

Product	Embedded Module			
Brand	AirPrime			
Test Model	HL7800			
Status of EUT	Engineering Sample			
Power Supply Rating	5.0 Vdc (host equipment) 12.0 Vdc (adapter)			
Modulation Type	Cat-M1	QPSK, 16QAM		
	NB-IoT	BPSK, QPSK		
Frequency Range	Cat-M1	LTE 5 (Channel Bandwidth: 1.4 MHz)	824.7 ~ 848.3 MHz	
		LTE 5 (Channel Bandwidth: 3 MHz)	825.5 ~ 847.5 MHz	
		LTE 5 (Channel Bandwidth: 5 MHz)	826.5 ~ 846.5 MHz	
		LTE 5 (Channel Bandwidth: 10 MHz)	829 ~ 844 MHz	
		LTE 26 (Channel Bandwidth: 1.4 MHz)	824.7 ~ 848.3 MHz	
		LTE 26 (Channel Bandwidth: 3 MHz)	825.5 ~ 847.5 MHz	
		LTE 26 (Channel Bandwidth: 5 MHz)	826.5 ~ 846.5 MHz	
		LTE 26 (Channel Bandwidth: 10 MHz)	829 ~ 844 MHz	
		LTE 26 (Channel Bandwidth: 15 MHz)	831.5 ~ 841.5 MHz	
		NB-IoT	LTE 5	824.2 ~ 848.8 MHz
LTE 26	824.2 ~ 848.8 MHz			
Max. ERP Power	Cat-M1	LTE 5 (Channel Bandwidth: 1.4 MHz)	213.30 mW	
		LTE 5 (Channel Bandwidth: 3 MHz)	225.42 mW	
		LTE 5 (Channel Bandwidth: 5 MHz)	239.33 mW	
		LTE 5 (Channel Bandwidth: 10 MHz)	252.93 mW	
		LTE 26 (Channel Bandwidth: 1.4 MHz)	179.89 mW	
		LTE 26 (Channel Bandwidth: 3 MHz)	191.87 mW	
		LTE 26 (Channel Bandwidth: 5 MHz)	203.70 mW	
		LTE 26 (Channel Bandwidth: 10 MHz)	216.77 mW	
	NB-IoT	LTE 5	183.65 mW (BPSK) 230.14 mW (QPSK)	
		LTE 26	165.20 mW (BPSK) 208.45 mW (QPSK)	

Emission Designator	Cat-M1	LTE 5 (Channel Bandwidth: 1.4 MHz)	1M09G7D
		LTE 5 (Channel Bandwidth: 3 MHz)	1M09G7D
		LTE 5 (Channel Bandwidth: 5 MHz)	1M09G7D
		LTE 5 (Channel Bandwidth: 10 MHz)	1M09G7D
		LTE 26 (Channel Bandwidth: 1.4 MHz)	1M09G7D
		LTE 26 (Channel Bandwidth: 3 MHz)	1M08G7D
		LTE 26 (Channel Bandwidth: 5 MHz)	1M09D7W
		LTE 26 (Channel Bandwidth: 10 MHz)	1M09G7D
		LTE 26 (Channel Bandwidth: 15 MHz)	1M10G7D
	NB-IoT	LTE 5	192KG7D
LTE 26		192KG7D	
Antenna Type	Dipole Antenna with 2 dBi gain		
Accessory Device	Refer to Note as below		
Data Cable Supplied	Refer to Note as below		

Note:

1. The above Antenna information is declared by manufacturer and for more detailed features description, please refer to the manufacturer's specifications, the laboratory shall not be held responsible.
2. The above EUT information is declared by manufacturer and for more detailed features description, please refers to the manufacturer's specifications or user's manual.

3.2 Configuration of System under Test

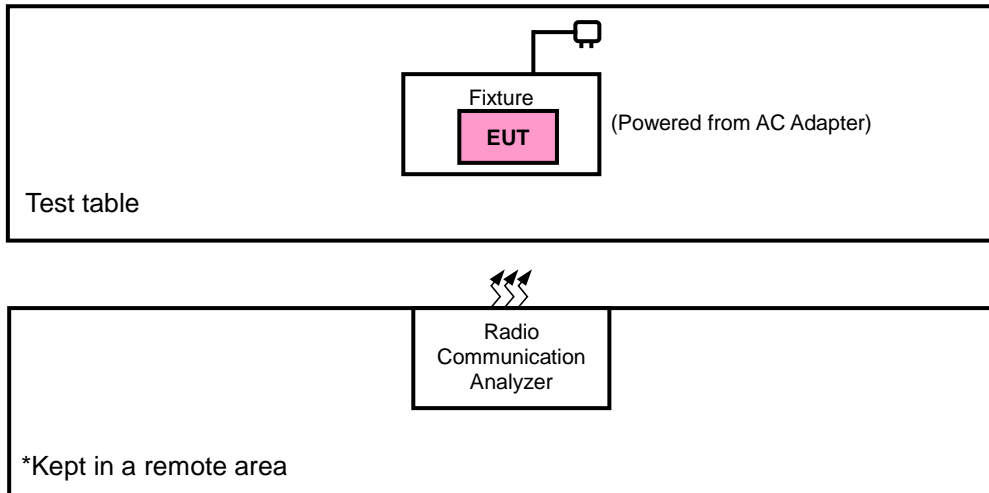

3.2.1 Description of Support Units

The EUT has been tested as an independent unit together with other necessary accessories or support units. The following support units or accessories were used to form a representative test configuration during the tests.

No.	Product	Brand	Model No.	Serial No.	FCC ID
1.	Adapter	N/A	N/A	N/A	N/A
2.	Radio Communication Analyzer	Anritsu	MT8821C	6201462755	N/A

No.	Signal Cable Description Of The Above Support Units
1.	N/A
2.	N/A

Note:

1. All power cords of the above support units are non-shielded (1.8m).
2. Item 1 was provided by client.

3.3 Test Mode Applicability and Tested Channel Detail

Pre-Scan has been conducted to determine the worst-case mode from all possible combinations between available modulations, data rates, XYZ axis, and antenna ports.

The worst case was found when positioned as the table below. Following channel(s) was (were) selected for the final test as listed below:

Band	ERP	Radiated Emission
LTE Band 5	X-plane	X-axis
LTE Band 26	X-plane	X-axis

Cat-M1

LTE Band 5

EUT Configure Mode	Test Item	Available Channel	Tested Channel	Channel Bandwidth	Modulation	Mode
-	ERP	20407 to 20643	20407, 20525, 20643	1.4 MHz	QPSK, 16QAM	1 RB / 0 RB Offset
		20415 to 20635	20415, 20525, 20635	3 MHz	QPSK, 16QAM	1 RB / 0 RB Offset
		20425 to 20625	20425, 20525, 20625	5 MHz	QPSK, 16QAM	1 RB / 0 RB Offset
		20450 to 20600	20450, 20525, 20600	10 MHz	QPSK, 16QAM	1 RB / 0 RB Offset
-	Modulation characteristics	20450 to 20600	20525	10 MHz	QPSK, 16QAM	6 RB / 0 RB Offset
-	Frequency Stability	20407 to 20643	20407, 20643	1.4 MHz	QPSK	6 RB / 0 RB Offset
		20415 to 20635	20415, 20635	3 MHz	QPSK	6 RB / 0 RB Offset
		20425 to 20625	20425, 20625	5 MHz	QPSK	6 RB / 0 RB Offset
		20450 to 20600	20450, 20600	10 MHz	QPSK	6 RB / 0 RB Offset
-	Occupied Bandwidth	20407 to 20643	20407, 20525, 20643	1.4 MHz	QPSK, 16QAM	6 RB / 0 RB Offset
		20415 to 20635	20415, 20525, 20635	3 MHz	QPSK, 16QAM	6 RB / 0 RB Offset
		20425 to 20625	20425, 20525, 20625	5 MHz	QPSK, 16QAM	6 RB / 0 RB Offset
		20450 to 20600	20450, 20525, 20600	10 MHz	QPSK, 16QAM	6 RB / 0 RB Offset
-	Band Edge	20407 to 20643	20407	1.4MHz	QPSK	1 RB / 0 RB Offset 6 RB / 0 RB Offset
			20643	1.4MHz	QPSK	1 RB / 5 RB Offset 6 RB / 0 RB Offset
		20415 to 20635	20415	3 MHz	QPSK	1 RB / 0 RB Offset 6 RB / 0 RB Offset
			20635	3 MHz	QPSK	1 RB / 5 RB Offset 6 RB / 0 RB Offset
		20425 to 20625	20425	5 MHz	QPSK	1 RB / 0 RB Offset 6 RB / 0 RB Offset
			20625	5 MHz	QPSK	1 RB / 5 RB Offset 6 RB / 0 RB Offset
		20450 to 20600	20450	10 MHz	QPSK	1 RB / 0 RB Offset 6 RB / 0 RB Offset
			20600	10 MHz	QPSK	1 RB / 5 RB Offset 6 RB / 0 RB Offset

EUT Configure Mode	Test Item	Available Channel	Tested Channel	Channel Bandwidth	Modulation	Mode
-	Peak to Average Ratio	20407 to 20643	20407, 20525, 20643	1.4 MHz	QPSK, 16QAM	1 RB / 0 RB Offset
		20415 to 20635	20415, 20525, 20635	3 MHz	QPSK, 16QAM	1 RB / 0 RB Offset
		20425 to 20625	20425, 20525, 20625	5 MHz	QPSK, 16QAM	1 RB / 0 RB Offset
		20450 to 20600	20450, 20525, 20600	10 MHz	QPSK, 16QAM	1 RB / 0 RB Offset
-	Conducted Emission	20407 to 20643	20407, 20525, 20643	1.4 MHz	QPSK	1 RB / 0 RB Offset
		20415 to 20635	20415, 20525, 20635	3 MHz	QPSK	1 RB / 0 RB Offset
		20425 to 20625	20425, 20525, 20625	5 MHz	QPSK	1 RB / 0 RB Offset
		20450 to 20600	20450, 20525, 20600	10 MHz	QPSK	1 RB / 0 RB Offset
-	Radiated Emission	20407 to 20643	20407, 20525, 20643	1.4 MHz	QPSK	1 RB / 0 RB Offset
		20425 to 20625	20425, 20525, 20625	5 MHz	QPSK	1 RB / 0 RB Offset
		20450 to 20600	20450, 20525, 20600	10 MHz	QPSK	1 RB / 0 RB Offset

Note:

1. This device was tested under all bandwidths, RB configurations and modulations. The worst case was found in QPSK modulation. Therefore, only ERP, modulation characteristics, occupied bandwidth and peak to average ratio items had been tested under QPSK, 16QAM mode, the other items were performed under QPSK mode only.
2. For radiated emission above 1 GHz, according to 3GPP 36.521 Section 6.6.3.1.4, choose the lowest, 5 MHz & highest channel bandwidth for final test.
3. For radiated emissions below 1 GHz, select the worst radiated emission channel for final testing.

LTE Band 26

EUT Configure Mode	Test Item	Available Channel	Tested Channel	Channel Bandwidth	Modulation	Mode
-	ERP	26797 to 27033	26797, 26915, 27033	1.4 MHz	QPSK, 16QAM	1 RB / 0 RB Offset
		26805 to 27025	26805, 26915, 27025	3 MHz	QPSK, 16QAM	1 RB / 0 RB Offset
		26815 to 27015	26815, 26915, 27015	5 MHz	QPSK, 16QAM	1 RB / 0 RB Offset
		26840 to 26990	26840, 26915, 26990	10 MHz	QPSK, 16QAM	4 RB / 2 RB Offset
		26865 to 26965	26865, 26915, 26965	15 MHz	QPSK, 16QAM	1 RB / 0 RB Offset
-	Modulation characteristics	26840 to 26990	26915	10 MHz	QPSK, 16QAM	6 RB / 0 RB Offset
-	Frequency Stability	26797 to 27033	26797, 27033	1.4 MHz	QPSK	6 RB / 0 RB Offset
		26805 to 27025	26805, 27025	3 MHz	QPSK	6 RB / 0 RB Offset
		26815 to 27015	26815, 27015	5 MHz	QPSK	6 RB / 0 RB Offset
		26840 to 26990	26840, 26990	10 MHz	QPSK	6 RB / 0 RB Offset
		26865 to 26965	26865, 26965	15 MHz	QPSK	6 RB / 0 RB Offset
-	Occupied Bandwidth	26797 to 27033	26797, 26915, 27033	1.4 MHz	QPSK, 16QAM	6 RB / 0 RB Offset
		26805 to 27025	26805, 26915, 27025	3 MHz	QPSK, 16QAM	6 RB / 0 RB Offset
		26815 to 27015	26815, 26915, 27015	5 MHz	QPSK, 16QAM	6 RB / 0 RB Offset
		26840 to 26990	26840, 26915, 26990	10 MHz	QPSK, 16QAM	6 RB / 0 RB Offset
		26865 to 26965	26865, 26915, 26965	15 MHz	QPSK, 16QAM	6 RB / 0 RB Offset

EUT Configure Mode	Test Item	Available Channel	Tested Channel	Channel Bandwidth	Modulation	Mode		
-	Band Edge	26797 to 27033	26797	1.4 MHz	QPSK	1 RB / 0 RB Offset 6 RB / 0 RB Offset		
			27033	1.4 MHz	QPSK	1 RB / 5 RB Offset 6 RB / 0 RB Offset		
		26805 to 27025	26805	3 MHz	QPSK	1 RB / 0 RB Offset 6 RB / 0 RB Offset		
			27025	3 MHz	QPSK	1 RB / 5 RB Offset 6 RB / 0 RB Offset		
		26815 to 27015	26815	5 MHz	QPSK	1 RB / 0 RB Offset 6 RB / 0 RB Offset		
			27015	5 MHz	QPSK	1 RB / 5 RB Offset 6 RB / 0 RB Offset		
		26840 to 26990	26840	10 MHz	QPSK	1 RB / 0 RB Offset 6 RB / 0 RB Offset		
			26990	10 MHz	QPSK	1 RB / 5 RB Offset 6 RB / 0 RB Offset		
		26865 to 26965	26865	15 MHz	QPSK	1 RB / 0 RB Offset 6 RB / 0 RB Offset		
			26965	15 MHz	QPSK	1 RB / 5 RB Offset 6 RB / 0 RB Offset		
		-	Peak to Average Ratio	26797 to 27033	26797, 26915, 27033	1.4 MHz	QPSK, 16QAM	1 RB / 0 RB Offset
				26805 to 27025	26805, 26915, 27025	3 MHz	QPSK, 16QAM	1 RB / 0 RB Offset
26815 to 27015	26815, 26915, 27015			5 MHz	QPSK, 16QAM	1 RB / 5 RB Offset		
26840 to 26990	26840, 26915, 26990			10 MHz	QPSK, 16QAM	4RB / 2 RB Offset		
26865 to 26965	26865, 26915, 26965			15 MHz	QPSK, 16QAM	1 RB / 0 RB Offset		
-	Conducted Emission	26797 to 27033	26797, 26915, 27033	1.4 MHz	QPSK	1 RB / 0 RB Offset		
		26805 to 27025	26805, 26915, 27025	3 MHz	QPSK	1 RB / 0 RB Offset		
		26815 to 27015	26815, 26915, 27015	5 MHz	QPSK	1 RB / 5 RB Offset		
		26840 to 26990	26840, 26915, 26990	10 MHz	QPSK	4 RB / 2 RB Offset		
		26865 to 26965	26865, 26915, 26965	15 MHz	QPSK	1 RB / 0 RB Offset		
-	Radiated Emission	26797 to 27033	26797, 26915, 27033	1.4 MHz	QPSK	1 RB / 0 RB Offset		
		26815 to 27015	26815, 26915, 27015	5 MHz	QPSK	1 RB / 5 RB Offset		
		26865 to 26965	26865, 26915, 26965	15 MHz	QPSK	1 RB / 0 RB Offset		

Note:

1. This device was tested under all bandwidths, RB configurations and modulations. The worst case was found in QPSK modulation. Therefore, only ERP, modulation characteristics, occupied bandwidth and peak to average ratio items had been tested under QPSK, 16QAM mode, the other items were performed under QPSK mode only.
2. For radiated emission above 1 GHz, according to 3GPP 36.521 Section 6.6.3.1.4, choose the lowest, 5 MHz & highest channel bandwidth for final test.
3. For radiated emissions below 1 GHz, select the worst radiated emission channel for final testing.

NB-IoT
LTE Band 5

EUT Configure Mode	Test Item	Available Channel	Tested Channel	Sub-carrier Bandwidth	Modulation	N _{tones}
-	ERP	20402 to 20648	20402, 20525, 20648	3.75 kHz	BPSK	1@47
				15 kHz	QPSK	3@3
-	Modulation Characteristics	20402 to 20648	20525	3.75 kHz	BPSK	1@0
				15 kHz	QPSK	12@0
-	Frequency Stability	20402 to 20648	20402, 20648	15 kHz	QPSK	12@0
-	Occupied Bandwidth	20402 to 20648	20402	3.75 kHz	BPSK	1@0
				15 kHz	QPSK	1@0
						3@3
						12@0
			20525	3.75 kHz	BPSK	1@0
				15 kHz	QPSK	1@0
						3@3
						12@0
			20648	3.75 kHz	BPSK	1@47
				15 kHz	QPSK	1@11
						3@3
						12@0
-	Band Edge	20402 to 20648	20402	3.75 kHz	BPSK	1@0
				15 kHz	QPSK	1@0
						3@3
						12@0
			20648	3.75 kHz	BPSK	1@47
				15 kHz	QPSK	1@11
						3@3
						12@0
-	Peak to Average Ratio	20402 to 20648	20525	3.75 kHz	BPSK	1@47
				15 kHz	QPSK	1@0
						3@3
-	Conducted Emission	20402 to 20648	20402, 20525, 20648	15 kHz	QPSK	3@3
-	Radiated Emission	20402 to 20648	20402, 20525, 20648	15 kHz	QPSK	3@3

Note:

1. Selection is tested with Stand-alone, In-band and Guard-band, the worst case was found in Stand-alone.
2. For radiated emission and conducted emission test, pre-tested BPSK, QPSK modulation type and found QPSK was the worst, therefore chosen for the final test.
3. The emission measurement was based on the worst maximum conducted power.

LTE Band 26

EUT Configure Mode	Test Item	Available Channel	Tested Channel	Sub-carrier Bandwidth	Modulation	N _{tones}			
-	ERP	26792 to 27038	26792, 26915, 27038	3.75 kHz	BPSK	1@0			
				15 kHz	QPSK	3@3			
-	Modulation Characteristics	26792 to 27038	26915	3.75 kHz	BPSK	1@0			
				15 kHz	QPSK	12@0			
-	Frequency Stability	26792 to 27038	26792, 27038	15 kHz	QPSK	12@0			
-	Occupied Bandwidth	26792 to 27038	26792	3.75 kHz	BPSK	1@0			
				15 kHz	QPSK	1@0			
						3@3			
						12@0			
				26915	3.75 kHz	BPSK	1@0		
					15 kHz	QPSK	1@0		
			3@3						
			27038	3.75 kHz	BPSK	1@47			
						15 kHz	QPSK	1@11	
								3@3	
				12@0					
				-	Band Edge	26792 to 27038	26792	3.75 kHz	BPSK
15 kHz	QPSK	1@0							
		3@3							
		12@0							
27038	3.75 kHz	BPSK	1@47						
	15 kHz	QPSK	1@11						
			3@3						
12@0									
-	Peak to Average Ratio	26792 to 27038	26915				3.75 kHz	BPSK	1@0
							15 kHz	QPSK	1@0
									3@3
-	Conducted Emission	26792 to 27038	26792, 26915, 27038				15 kHz	QPSK	3@3
-	Radiated Emission	26792 to 27038	26792, 26915, 27038	15 kHz	QPSK	3@3			

Note:

1. Selection is tested with Stand-alone, In-band and Guard-band, the worst case was found in Stand-alone.
2. For radiated emission and conducted emission test, pre-tested BPSK, QPSK modulation type and found QPSK was the worst, therefore chosen for the final test.
3. The emission measurement was based on the worst maximum conducted power.

Test Condition:

Test Item	Environmental Conditions	Input Power	Tested By
ERP	25 deg. C, 65 % RH	12 Vdc	Jisyong Wang
Modulation Characteristics	25 deg. C, 65 % RH	12 Vdc	Getaz Yang
Frequency Stability	25 deg. C, 65 % RH	12 Vdc	Getaz Yang
Occupied Bandwidth	25 deg. C, 65 % RH	12 Vdc	Getaz Yang
Band Edge	25 deg. C, 65 % RH	12 Vdc	Getaz Yang
Peak to Average Ratio	25 deg. C, 65 % RH	12 Vdc	Getaz Yang
Conducted Emission	25 deg. C, 65 % RH	12 Vdc	Getaz Yang
Radiated Emission	25 deg. C, 65 % RH	12 Vdc	Jisyong Wang

3.4 EUT Operating Conditions

The EUT makes a call to the communication simulator. The communication simulator station system controlled a EUT to export maximum output power under transmission mode and specific channel frequency.

3.5 General Description of Applied Standards

The EUT is a RF Product. According to the specifications of the manufacturer, it must comply with the requirements of the following standards and references:

Test Standard:

FCC 47 CFR Part 2

FCC 47 CFR Part 22

ANSI 63.26-2015

Note: All test items have been performed and recorded as per the above standards.

References Test Guidance:

KDB 971168 D01 Power Meas License Digital Systems v03r01

ANSI/TIA/EIA-603-E 2016

Note: All test items have been performed as a reference to the above KDB test guidance.

4 Test Types and Results

4.1 Output Power Measurement

4.1.1 Limits of Output Power Measurement

Mobile / Portable station are limited to 7 watts e.r.p.

4.1.2 Test Procedures

EIRP / ERP Measurement:

- a. All measurements were done at low, middle and high operational frequency range. RBW is 10 MHz - 15 MHz for LTE mode, and VBW $\geq 3 \times$ RBW.
- b. Substitution method is used for E.I.R.P measurement. In the semi-anechoic chamber, EUT placed on the 0.8 m (below or equal 1 GHz) and/or 1.5 m (above 1 GHz) height of Turn Table, rotated the table around 360 degrees to search the maximum radiation power and receiver antenna shall be rotated vertical and horizontal polarization and moved height from 1 m to 4 m to find the maximum polar radiated power. The "Read Value" is the spectrum reading the maximum power value.
- c. The substitution horn antenna is substituted for EUT at the same position and signals generator export the CW signal to the substitution antenna via a tx cable. Rotated the Turn Table and moved receiving antenna to find the maximum radiation power. Adjust output power level of S.G to get a Value of spectrum reading equal to "Read Value" of step b. Record the power level of S.G.
- d. $EIRP = \text{Output power level of S.G} - \text{TX cable loss} + \text{Antenna gain of substitution horn}$. E.R.P power can be calculated from E.I.R.P power by subtracting the gain of dipole, $E.R.P \text{ power} = E.I.R.P \text{ power} - 2.15 \text{ dB}$.

Conducted Power Measurement:

The EUT was set up for the maximum power with LTE link data modulation and link up with simulator. Set the EUT to transmit under low, middle and high channel and record the power level shown on simulator.

4.1.3 Test Setup

EIRP / ERP Measurement:

<Radiated Emission below or equal 1 GHz>

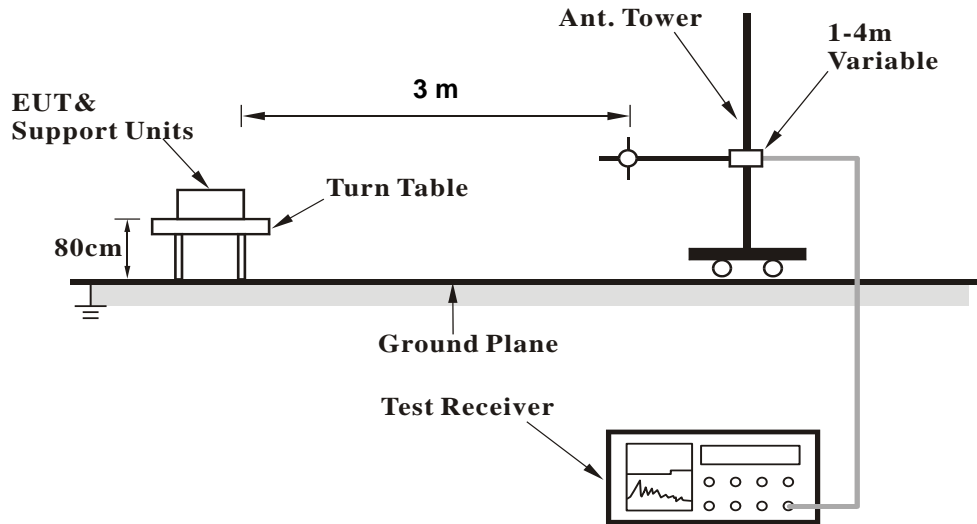

<Radiated Emission above 1 GHz>

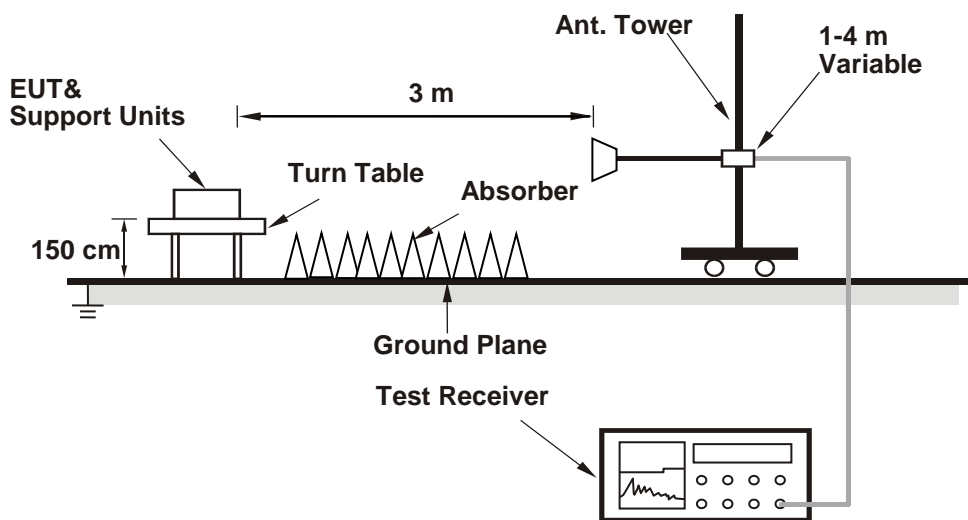

For the actual test configuration, please refer to the attached file (Test Setup Photo).

Conducted Power Measurement:

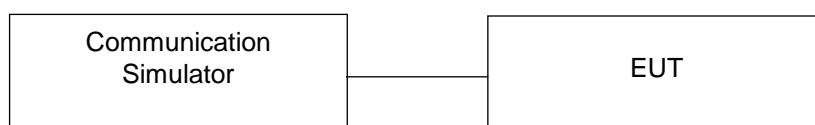

4.1.4 Test Results

Conducted Output Power (dBm)

Cat-M1

LTE Band 5								
BW (MHz): 1.4								
Test Frequency ID	N _{UL}	Frequency of Uplink (MHz)	Test Configuration Initial of Power				EUT	
			Modulation	RB Size	RB Offset	Narrowband Index	Cell Power (dBm/15 kHz)	Power (dBm)
Low Range	20407	824.7	QPSK	1	0	0	-85	23.90
			QPSK	1	5	0	-85	23.34
			QPSK	3	3	0	-85	21.73
			QPSK	6	0	0	-85	20.92
			16QAM	1	0	0	-85	21.30
			16QAM	1	5	0	-85	21.47
			16QAM	3	0	0	-85	20.72
Mid. Range	20525	836.5	QPSK	1	0	0	-85	23.80
			QPSK	1	5	0	-85	23.37
			QPSK	3	3	0	-85	21.70
			QPSK	6	0	0	-85	20.88
			16QAM	1	0	0	-85	21.26
			16QAM	1	5	0	-85	21.35
			16QAM	3	0	0	-85	20.68
High Range	20643	848.3	QPSK	1	0	0	-85	23.81
			QPSK	1	5	0	-85	23.34
			QPSK	3	3	0	-85	21.76
			QPSK	6	0	0	-85	20.90
			16QAM	1	0	0	-85	21.30
			16QAM	1	5	0	-85	21.38
			16QAM	3	0	0	-85	20.63
			16QAM	6	0	0	-85	20.37

LTE Band 5								
BW (MHz): 3								
Test Frequency ID	N _{UL}	Frequency of Uplink (MHz)	Test Configuration Initial of Power				EUT	
			Modulation	RB Size	RB Offset	Narrowband Index	Cell Power (dBm/15 kHz)	Power (dBm)
Low Range	20415	825.5	QPSK	1	0	0	-85	22.96
			QPSK	1	5	0	-85	22.83
			QPSK	1	0	1	-85	22.86
			QPSK	1	5	1	-85	22.76
			QPSK	3	3	0	-85	21.72
			QPSK	3	3	1	-85	21.63
			QPSK	6	0	0	-85	20.75
			QPSK	6	0	1	-85	20.65
			16QAM	1	0	0	-85	22.83
			16QAM	1	5	0	-85	22.74
			16QAM	1	0	1	-85	22.73
			16QAM	1	5	1	-85	22.67
			16QAM	3	0	0	-85	21.68
			16QAM	3	3	1	-85	21.68
			16QAM	5	0	0	-85	21.63
16QAM	5	0	1	-85	21.56			
Mid. Range	20525	836.5	QPSK	1	0	0	-85	22.82
			QPSK	1	5	0	-85	22.67
			QPSK	1	0	1	-85	22.95
			QPSK	1	5	1	-85	22.83
			QPSK	3	3	0	-85	21.71
			QPSK	3	3	1	-85	21.73
			QPSK	6	0	0	-85	20.78
			QPSK	6	0	1	-85	20.86
			16QAM	1	0	0	-85	22.63
			16QAM	1	5	0	-85	22.80
			16QAM	1	0	1	-85	23.00
			16QAM	1	5	1	-85	22.74
			16QAM	3	0	0	-85	21.74
			16QAM	3	3	1	-85	21.79
			16QAM	5	0	0	-85	21.73
16QAM	5	0	1	-85	21.68			
High Range	20635	2063.5	QPSK	1	0	0	-85	22.89
			QPSK	1	5	0	-85	22.82
			QPSK	1	0	1	-85	22.83
			QPSK	1	5	1	-85	22.77
			QPSK	3	3	0	-85	21.69
			QPSK	3	3	1	-85	21.62
			QPSK	6	0	0	-85	20.77
			QPSK	6	0	1	-85	20.61
			16QAM	1	0	0	-85	22.73
			16QAM	1	5	0	-85	22.63
			16QAM	1	0	1	-85	22.58
			16QAM	1	5	1	-85	22.71
			16QAM	3	0	0	-85	21.75
			16QAM	3	3	1	-85	21.80
			16QAM	5	0	0	-85	21.76
16QAM	5	0	1	-85	21.74			

LTE Band 5								
BW (MHz): 5		Test Configuration Initial of Power						
Test Frequency ID	N _{UL}	Frequency of Uplink (MHz)	Test Configuration				EUT	
			Modulation	RB Size	RB Offset	Narrowband Index	Cell Power (dBm/15 kHz)	Power (dBm)
Low Range	20425	826.5	QPSK	1	0	0	-85	22.90
			QPSK	1	5	0	-85	22.87
			QPSK	1	0	1	-85	22.85
			QPSK	1	5	1	-85	22.86
			QPSK	1	0	3	-85	22.84
			QPSK	1	5	3	-85	22.79
			QPSK	3	0	0	-85	22.06
			QPSK	3	3	3	-85	21.86
			QPSK	6	0	0	-85	22.08
			QPSK	6	0	1	-85	22.00
			QPSK	6	0	3	-85	22.06
			16QAM	1	0	0	-85	22.68
			16QAM	1	5	0	-85	22.75
			16QAM	1	0	1	-85	22.73
			16QAM	1	5	1	-85	22.74
			16QAM	1	0	3	-85	22.72
			16QAM	1	5	3	-85	22.75
			16QAM	3	0	0	-85	21.86
16QAM	3	3	3	-85	21.88			
16QAM	5	0	0	-85	21.88			
16QAM	5	0	1	-85	21.90			
16QAM	5	0	3	-85	21.91			
Mid. Range	20525	836.5	QPSK	1	0	0	-85	22.77
			QPSK	1	5	0	-85	22.73
			QPSK	1	0	1	-85	22.74
			QPSK	1	5	1	-85	22.52
			QPSK	1	0	3	-85	22.76
			QPSK	1	5	3	-85	22.62
			QPSK	3	0	0	-85	21.88
			QPSK	3	3	3	-85	21.70
			QPSK	6	0	0	-85	21.92
			QPSK	6	0	1	-85	21.95
			QPSK	6	0	3	-85	21.86
			16QAM	1	0	0	-85	22.57
			16QAM	1	5	0	-85	22.53
			16QAM	1	0	1	-85	22.63
			16QAM	1	5	1	-85	22.61
			16QAM	1	0	3	-85	22.62
			16QAM	1	5	3	-85	22.52
			16QAM	3	0	0	-85	21.76
			16QAM	3	3	3	-85	21.75
			16QAM	5	0	0	-85	21.82
16QAM	5	0	1	-85	21.72			
16QAM	5	0	3	-85	21.76			

LTE Band 5								
BW (MHz): 5								
Test Frequency ID	N _{UL}	Frequency of Uplink (MHz)	Test Configuration Initial of Power				EUT	
			Modulation	RB Size	RB Offset	Narrowband Index	Cell Power (dBm/15 kHz)	Power (dBm)
High Range	20625	846.5	QPSK	1	0	0	-85	22.77
			QPSK	1	5	0	-85	22.70
			QPSK	1	0	1	-85	23.00
			QPSK	1	5	1	-85	22.85
			QPSK	1	0	3	-85	22.68
			QPSK	1	5	3	-85	22.57
			QPSK	3	0	0	-85	21.80
			QPSK	3	3	3	-85	21.65
			QPSK	6	0	0	-85	21.79
			QPSK	6	0	1	-85	22.19
			QPSK	6	0	3	-85	21.86
			16QAM	1	0	0	-85	22.50
			16QAM	1	5	0	-85	22.38
			16QAM	1	0	1	-85	22.91
			16QAM	1	5	1	-85	22.84
			16QAM	1	0	3	-85	22.49
			16QAM	1	5	3	-85	22.43
			16QAM	3	0	0	-85	21.54
			16QAM	3	3	3	-85	21.65
			16QAM	5	0	0	-85	21.68
16QAM	5	0	1	-85	22.06			
16QAM	5	0	3	-85	21.77			

LTE Band 5								
BW (MHz): 10								
Test Frequency ID	N _{UL}	Frequency of Uplink (MHz)	Test Configuration Initial of Power				EUT	
			Modulation	RB Size	RB Offset	Narrowband Index	Cell Power (dBm/15 kHz)	Power (dBm)
Low Range	20450	829	QPSK	1	0	0	-85	24.03
			QPSK	1	5	0	-85	22.73
			QPSK	1	0	3	-85	22.70
			QPSK	1	5	3	-85	22.70
			QPSK	1	0	7	-85	22.70
			QPSK	1	5	7	-85	22.65
			QPSK	4	0	0	-85	22.80
			QPSK	4	2	7	-85	22.97
			QPSK	6	0	0	-85	21.82
			QPSK	6	0	7	-85	21.76
			16QAM	1	0	0	-85	22.83
			16QAM	1	5	0	-85	22.77
			16QAM	1	0	3	-85	22.77
			16QAM	1	5	3	-85	22.73
			16QAM	1	0	7	-85	22.67
			16QAM	1	5	7	-85	22.63
			16QAM	4	2	0	-85	22.82
			16QAM	4	2	7	-85	22.79
16QAM	5	0	0	-85	21.83			
16QAM	5	0	7	-85	21.85			
Mid. Range	20525	836.5	QPSK	1	0	0	-85	24.22
			QPSK	1	5	0	-85	22.73
			QPSK	1	0	3	-85	22.71
			QPSK	1	5	3	-85	22.76
			QPSK	1	0	7	-85	22.57
			QPSK	1	5	7	-85	22.55
			QPSK	4	0	0	-85	22.78
			QPSK	4	2	7	-85	22.79
			QPSK	6	0	0	-85	21.94
			QPSK	6	0	7	-85	21.72
			16QAM	1	0	0	-85	22.81
			16QAM	1	5	0	-85	22.74
			16QAM	1	0	3	-85	22.85
			16QAM	1	5	3	-85	22.77
			16QAM	1	0	7	-85	22.65
			16QAM	1	5	7	-85	22.58
			16QAM	4	2	0	-85	22.91
			16QAM	4	2	7	-85	22.82
16QAM	5	0	0	-85	21.86			
16QAM	5	0	7	-85	21.77			
High Range	20600	844	QPSK	1	0	0	-85	24.01
			QPSK	1	5	0	-85	22.65
			QPSK	1	5	7	-85	22.95
			QPSK	1	0	3	-85	22.94
			QPSK	1	5	3	-85	22.89
			QPSK	1	0	7	-85	23.00
			QPSK	4	0	0	-85	22.61
			QPSK	4	2	7	-85	22.96
			QPSK	6	0	0	-85	21.61
			QPSK	6	0	7	-85	22.06
			16QAM	1	0	0	-85	22.74
			16QAM	1	5	0	-85	22.61
			16QAM	1	0	3	-85	22.87
			16QAM	1	5	3	-85	22.65
			16QAM	1	0	7	-85	23.03
			16QAM	1	5	7	-85	22.91
			16QAM	4	2	0	-85	22.68
			16QAM	4	2	7	-85	22.79
16QAM	5	0	0	-85	21.73			
16QAM	5	0	7	-85	22.02			

LTE Band 26								
BW (MHz): 1.4								
Test Frequency ID	N _{UL}	Frequency of Uplink (MHz)	Test Configuration Initial of Power				EUT	
			Modulation	RB Size	RB Offset	Narrowband Index	Cell Power (dBm/15 kHz)	Power (dBm)
Low Range	26797	824.7	QPSK	1	0	0	-85	23.53
			QPSK	1	5	0	-85	23.55
			QPSK	3	3	0	-85	22.13
			QPSK	6	0	0	-85	21.29
			16QAM	1	0	0	-85	23.15
			16QAM	1	5	0	-85	23.06
			16QAM	3	0	0	-85	22.29
Mid. Range	26915	836.5	16QAM	5	0	0	-85	22.03
			QPSK	1	0	0	-85	23.35
			QPSK	1	5	0	-85	23.45
			QPSK	3	3	0	-85	22.06
			QPSK	6	0	0	-85	21.32
			16QAM	1	0	0	-85	23.19
			16QAM	1	5	0	-85	23.09
High Range	27033	848.3	16QAM	3	0	0	-85	22.34
			16QAM	5	0	0	-85	22.13
			QPSK	1	0	0	-85	23.72
			QPSK	1	5	0	-85	23.69
			QPSK	3	3	0	-85	22.20
			QPSK	6	0	0	-85	21.35
			16QAM	1	0	0	-85	23.25
			16QAM	1	5	0	-85	23.26
			16QAM	3	0	0	-85	22.38
			16QAM	5	0	0	-85	22.22

LTE Band 26								
BW (MHz): 3								
Test Frequency ID	N _{UL}	Frequency of Uplink (MHz)	Test Configuration Initial of Power				EUT	
			Modulation	RB Size	RB Offset	Narrowband Index	Cell Power (dBm/15 kHz)	Power (dBm)
Low Range	26805	825.5	QPSK	1	0	0	-85	23.32
			QPSK	1	5	0	-85	23.54
			QPSK	1	0	1	-85	23.46
			QPSK	1	5	1	-85	23.56
			QPSK	3	3	0	-85	22.23
			QPSK	3	3	1	-85	22.20
			QPSK	6	0	0	-85	21.36
			QPSK	6	0	1	-85	21.27
			16QAM	1	0	0	-85	23.27
			16QAM	1	5	0	-85	23.09
			16QAM	1	0	1	-85	23.50
			16QAM	1	5	1	-85	23.52
			16QAM	3	0	0	-85	22.56
			16QAM	3	3	1	-85	22.22
Mid. Range	26915	836.5	16QAM	5	0	0	-85	22.30
			16QAM	5	0	1	-85	22.44
			QPSK	1	0	0	-85	23.49
			QPSK	1	5	0	-85	23.41
			QPSK	1	0	1	-85	23.50
			QPSK	1	5	1	-85	23.50
			QPSK	3	3	0	-85	23.47
			QPSK	3	3	1	-85	22.34
			QPSK	6	0	0	-85	21.26
			QPSK	6	0	1	-85	21.36
			16QAM	1	0	0	-85	23.31
			16QAM	1	5	0	-85	23.21
			16QAM	1	0	1	-85	23.27
			16QAM	1	5	1	-85	23.20
High Range	27025	847.5	16QAM	3	0	0	-85	22.49
			16QAM	3	3	1	-85	22.45
			16QAM	5	0	0	-85	22.40
			16QAM	5	0	1	-85	22.43
			QPSK	1	0	0	-85	23.62
			QPSK	1	5	0	-85	23.47
			QPSK	1	0	1	-85	23.43
			QPSK	1	5	1	-85	23.53
			QPSK	3	3	0	-85	22.36
			QPSK	3	3	1	-85	22.42
			QPSK	6	0	0	-85	21.41
			QPSK	6	0	1	-85	21.33
			16QAM	1	0	0	-85	23.33
			16QAM	1	5	0	-85	23.33
16QAM	1	0	1	-85	23.59			
16QAM	1	5	1	-85	23.56			
16QAM	3	0	0	-85	22.59			
16QAM	3	3	1	-85	22.44			
16QAM	5	0	0	-85	22.52			
16QAM	5	0	1	-85	22.49			

LTE Band 26								
BW (MHz): 5								
Test Frequency ID	N _{UL}	Frequency of Uplink (MHz)	Test Configuration Initial of Power				EUT	
			Modulation	RB Size	RB Offset	Narrowband Index	Cell Power (dBm/15 kHz)	Power (dBm)
Low Range	26815	826.5	QPSK	1	0	0	-85	23.23
			QPSK	1	5	0	-85	23.25
			QPSK	1	0	1	-85	23.20
			QPSK	1	5	1	-85	23.23
			QPSK	1	0	3	-85	23.36
			QPSK	1	5	3	-85	23.39
			QPSK	3	0	0	-85	22.54
			QPSK	3	3	3	-85	22.26
			QPSK	6	0	0	-85	22.26
			QPSK	6	0	1	-85	22.48
			QPSK	6	0	3	-85	22.35
			16QAM	1	0	0	-85	23.25
			16QAM	1	5	0	-85	23.27
			16QAM	1	0	1	-85	23.23
			16QAM	1	5	1	-85	23.10
			16QAM	1	0	3	-85	23.27
			16QAM	1	5	3	-85	23.22
			16QAM	3	0	0	-85	22.43
16QAM	3	3	3	-85	22.43			
16QAM	5	0	0	-85	22.43			
16QAM	5	0	1	-85	22.41			
16QAM	5	0	3	-85	22.44			
Mid. Range	26915	836.5	QPSK	1	0	0	-85	23.37
			QPSK	1	5	0	-85	23.33
			QPSK	1	0	1	-85	23.33
			QPSK	1	5	1	-85	23.45
			QPSK	1	0	3	-85	23.34
			QPSK	1	5	3	-85	23.40
			QPSK	3	0	0	-85	22.74
			QPSK	3	3	3	-85	22.24
			QPSK	6	0	0	-85	22.32
			QPSK	6	0	1	-85	22.62
			QPSK	6	0	3	-85	22.28
			16QAM	1	0	0	-85	23.22
			16QAM	1	5	0	-85	23.22
			16QAM	1	0	1	-85	23.24
			16QAM	1	5	1	-85	23.30
			16QAM	1	0	3	-85	23.30
			16QAM	1	5	3	-85	23.18
			16QAM	3	0	0	-85	22.60
16QAM	3	3	3	-85	22.49			
16QAM	5	0	0	-85	22.45			
16QAM	5	0	1	-85	22.39			
16QAM	5	0	3	-85	22.36			

LTE Band 26								
BW (MHz): 5								
Test Frequency ID	N _{UL}	Frequency of Uplink (MHz)	Test Configuration Initial of Power				EUT	
			Modulation	RB Size	RB Offset	Narrowband Index	Cell Power (dBm/15 kHz)	Power (dBm)
High Range	27015	846.5	QPSK	1	0	0	-85	23.34
			QPSK	1	5	0	-85	23.64
			QPSK	1	0	1	-85	23.41
			QPSK	1	5	1	-85	23.49
			QPSK	1	0	3	-85	23.28
			QPSK	1	5	3	-85	23.32
			QPSK	3	0	0	-85	22.95
			QPSK	3	3	3	-85	22.73
			QPSK	6	0	0	-85	22.55
			QPSK	6	0	1	-85	22.43
			QPSK	6	0	3	-85	22.20
			16QAM	1	0	0	-85	23.60
			16QAM	1	5	0	-85	23.53
			16QAM	1	0	1	-85	23.25
			16QAM	1	5	1	-85	23.38
			16QAM	1	0	3	-85	23.31
			16QAM	1	5	3	-85	23.23
			16QAM	3	0	0	-85	22.69
			16QAM	3	3	3	-85	22.62
			16QAM	5	0	0	-85	22.71
16QAM	5	0	1	-85	22.42			
16QAM	5	0	3	-85	22.64			

LTE Band 26								
BW (MHz): 10								
Test Frequency ID	N _{UL}	Frequency of Uplink (MHz)	Test Configuration Initial of Power				EUT	
			Modulation	RB Size	RB Offset	Narrowband Index	Cell Power (dBm/15 kHz)	Power (dBm)
Low Range	26840	829	QPSK	1	0	0	-85	23.10
			QPSK	1	5	0	-85	23.25
			QPSK	1	0	3	-85	23.26
			QPSK	1	5	3	-85	23.20
			QPSK	1	0	7	-85	23.31
			QPSK	1	5	7	-85	23.37
			QPSK	4	0	0	-85	23.23
			QPSK	4	2	7	-85	23.46
			QPSK	6	0	0	-85	22.32
			QPSK	6	0	7	-85	22.75
			16QAM	1	0	0	-85	23.50
			16QAM	1	5	0	-85	23.17
			16QAM	1	0	3	-85	23.24
			16QAM	1	5	3	-85	23.21
			16QAM	1	0	7	-85	23.50
			16QAM	1	5	7	-85	23.43
			16QAM	4	2	0	-85	23.21
			16QAM	4	2	7	-85	23.46
			16QAM	5	0	0	-85	22.37
			16QAM	5	0	7	-85	22.53
Mid. Range	26915	836.5	QPSK	1	0	0	-85	23.08
			QPSK	1	5	0	-85	23.28
			QPSK	1	0	3	-85	23.25
			QPSK	1	5	3	-85	23.20
			QPSK	1	0	7	-85	23.39
			QPSK	1	5	7	-85	23.40
			QPSK	4	0	0	-85	23.24
			QPSK	4	2	7	-85	23.48
			QPSK	6	0	0	-85	22.55
			QPSK	6	0	7	-85	22.86
			16QAM	1	0	0	-85	23.54
			16QAM	1	5	0	-85	23.19
			16QAM	1	0	3	-85	23.19
			16QAM	1	5	3	-85	23.42
			16QAM	1	0	7	-85	23.57
			16QAM	1	5	7	-85	23.42
			16QAM	4	2	0	-85	23.25
			16QAM	4	2	7	-85	23.11
			16QAM	5	0	0	-85	22.53
			16QAM	5	0	7	-85	22.50
High Range	26990	844	QPSK	1	0	0	-85	23.21
			QPSK	1	5	0	-85	23.25
			QPSK	1	5	7	-85	23.30
			QPSK	1	0	3	-85	23.29
			QPSK	1	5	3	-85	23.31
			QPSK	1	0	7	-85	23.42
			QPSK	4	0	0	-85	23.20
			QPSK	4	2	7	-85	23.58
			QPSK	6	0	0	-85	22.53
			QPSK	6	0	7	-85	22.63
			16QAM	1	0	0	-85	23.50
			16QAM	1	5	0	-85	23.33
			16QAM	1	0	3	-85	23.19
			16QAM	1	5	3	-85	23.24
			16QAM	1	0	7	-85	23.26
			16QAM	1	5	7	-85	23.34
			16QAM	4	2	0	-85	23.30
			16QAM	4	2	7	-85	23.16
			16QAM	5	0	0	-85	22.46
			16QAM	5	0	7	-85	22.49

LTE Band 26								
BW (MHz): 15								
Test Frequency ID	N _{UL}	Frequency of Uplink (MHz)	Test Configuration Initial of Power				EUT	
			Modulation	RB Size	RB Offset	Narrowband Index	Cell Power (dBm/15 kHz)	Power (dBm)
Low Range	26865	831.5	QPSK	1	0	0	-85	23.78
			QPSK	1	5	0	-85	23.74
			QPSK	1	0	5	-85	23.21
			QPSK	1	5	5	-85	23.34
			QPSK	1	0	11	-85	23.24
			QPSK	1	5	11	-85	23.23
			QPSK	3	0	0	-85	23.43
			QPSK	3	3	11	-85	23.19
			QPSK	6	0	0	-85	23.20
			QPSK	6	0	11	-85	23.32
			16QAM	1	0	0	-85	23.40
			16QAM	1	5	0	-85	23.33
			16QAM	1	0	5	-85	23.41
			16QAM	1	5	5	-85	23.26
			16QAM	1	0	11	-85	23.09
			16QAM	1	5	11	-85	23.24
			16QAM	3	0	0	-85	23.24
			16QAM	3	3	11	-85	23.28
16QAM	5	0	0	-85	23.21			
16QAM	5	0	11	-85	23.24			
Mid. Range	26915	836.5	QPSK	1	0	0	-85	23.72
			QPSK	1	5	0	-85	23.69
			QPSK	1	0	5	-85	23.34
			QPSK	1	5	5	-85	23.33
			QPSK	1	0	11	-85	23.15
			QPSK	1	5	11	-85	23.15
			QPSK	3	0	0	-85	23.40
			QPSK	3	3	11	-85	23.09
			QPSK	6	0	0	-85	23.25
			QPSK	6	0	11	-85	23.26
			16QAM	1	0	0	-85	23.42
			16QAM	1	5	0	-85	23.26
			16QAM	1	0	5	-85	23.43
			16QAM	1	5	5	-85	23.49
			16QAM	1	0	11	-85	23.21
			16QAM	1	5	11	-85	23.32
			16QAM	3	0	0	-85	23.34
			16QAM	3	3	11	-85	23.22
16QAM	5	0	0	-85	23.29			
16QAM	5	0	11	-85	23.30			
High Range	26965	841.5	QPSK	1	0	0	-85	23.69
			QPSK	1	5	11	-85	23.65
			QPSK	1	0	5	-85	23.57
			QPSK	1	5	5	-85	23.51
			QPSK	1	0	11	-85	23.59
			QPSK	1	5	11	-85	23.52
			QPSK	3	0	0	-85	23.30
			QPSK	3	3	11	-85	23.51
			QPSK	6	0	0	-85	23.25
			QPSK	6	0	11	-85	23.25
			16QAM	1	0	0	-85	23.48
			16QAM	1	5	0	-85	23.34
			16QAM	1	0	5	-85	23.55
			16QAM	1	5	5	-85	23.52
			16QAM	1	0	11	-85	23.45
			16QAM	1	5	11	-85	23.45
			16QAM	3	0	0	-85	23.30
			16QAM	3	3	11	-85	23.33
16QAM	5	0	0	-85	23.33			
16QAM	5	0	11	-85	23.27			

NB-IoT

LTE Band 5							
Stand-alone							
N _{UL}	M _{UL}	Frequency of Uplink (MHz)	Test Configuration Initial of Power			EUT	
			Modulation	N _{tones}	Sub-carrier Spacing (kHz)	Cell Power (dBm/15 kHz)	Power (dBm)
20402	0	824.2	BPSK	1@0	3.75	-110	22.68
			BPSK	1@0	15	-110	22.7
			QPSK	1@0	3.75	-110	22.73
			QPSK	1@0	15	-110	22.76
			QPSK	3@3	15	-110	22.88
			QPSK	12@0	15	-110	21.59
20525	0	836.5	BPSK	1@0	3.75	-110	23.41
			BPSK	1@0	15	-110	23.45
			BPSK	1@47	3.75	-110	23.42
			QPSK	1@0	3.75	-110	23.51
			QPSK	1@0	15	-110	23.56
			QPSK	1@11	15	-110	23.49
			QPSK	3@3	15	-110	23.77
			QPSK	12@0	15	-110	23.31
20648	0	848.8	BPSK	1@47	3.75	-110	22.46
			BPSK	1@11	15	-110	22.48
			QPSK	1@47	3.75	-110	22.49
			QPSK	1@11	15	-110	22.52
			QPSK	3@3	15	-110	22.78
			QPSK	12@0	15	-110	21.69

LTE Band 5							
In-Band	BW (MHz): 3						
N _{UL}	M _{UL}	Frequency of Uplink (MHz)	Test Configuration Initial of Power			EUT	
			Modulation	N _{tones}	Sub-carrier Spacing (kHz)	Cell Power (dBm/15 kHz)	Power (dBm)
20407	0	824.7	BPSK	1@0	3.75	-110	22.55
			QPSK	1@0	15	-110	22.67
			QPSK	3@3	15	-110	22.77
			QPSK	12@0	15	-110	21.46
20516	0	835.6	BPSK	1@0	3.75	-110	23.31
			BPSK	1@47	3.75	-110	23.26
			QPSK	1@0	15	-110	23.43
			QPSK	1@11	15	-110	23.40
			QPSK	3@3	15	-110	23.64
			QPSK	12@0	15	-110	23.18
20643	0	848.3	BPSK	1@47	3.75	-110	22.31
			QPSK	1@11	15	-110	22.41
			QPSK	3@3	15	-110	22.64
			QPSK	12@0	15	-110	21.53

LTE Band 5							
In-Band	BW (MHz): 10	NB-IoT PRB: 30	Test Configuration Initial of Power			EUT	
N _{UL}	M _{UL}	Frequency of Uplink (MHz)	Modulation	N _{tones}	Sub-carrier Spacing (kHz)	Cell Power (dBm/15 kHz)	Power (dBm)
20461	-2	830.09	BPSK	1@0	3.75	-110	22.54
			QPSK	1@0	15	-110	22.61
			QPSK	3@3	15	-110	22.79
			QPSK	12@0	15	-110	21.48
20535	-2	837.49	BPSK	1@0	3.75	-110	23.28
			BPSK	1@47	3.75	-110	23.33
			QPSK	1@0	15	-110	23.47
			QPSK	1@11	15	-110	23.36
			QPSK	3@3	15	-110	23.67
20609	-2	844.89	QPSK	12@0	15	-110	23.22
			BPSK	1@47	3.75	-110	22.32
			QPSK	1@11	15	-110	22.41
			QPSK	3@3	15	-110	22.63
			QPSK	12@0	15	-110	21.54

LTE Band 5							
In-Band	BW (MHz): 10	NB-IoT PRB: 35	Test Configuration Initial of Power			EUT	
N _{UL}	M _{UL}	Frequency of Uplink (MHz)	Modulation	N _{tones}	Sub-carrier Spacing (kHz)	Cell Power (dBm/15 kHz)	Power (dBm)
20470	-2	830.99	BPSK	1@0	3.75	-110	22.57
			QPSK	1@0	15	-110	22.65
			QPSK	3@3	15	-110	22.76
			QPSK	12@0	15	-110	21.47
20544	-2	838.39	BPSK	1@0	3.75	-110	23.26
			BPSK	1@47	3.75	-110	23.29
			QPSK	1@0	15	-110	23.41
			QPSK	1@11	15	-110	23.36
			QPSK	3@3	15	-110	23.62
20618	-2	845.79	QPSK	12@0	15	-110	23.20
			BPSK	1@47	3.75	-110	22.37
			QPSK	1@11	15	-110	22.36
			QPSK	3@3	15	-110	22.67
			QPSK	12@0	15	-110	21.59

LTE Band 5							
Guard-Band	BW (MHz): 5						
N _{UL}	M _{UL}	Frequency of Uplink (MHz)	Test Configuration Initial of Power			EUT	
			Modulation	N _{tones}	Sub-carrier Spacing (kHz)	Cell Power (dBm/15 kHz)	Power (dBm)
20402	0	824.2	BPSK	1@0	3.75	-110	22.59
			QPSK	1@0	15	-110	22.60
			QPSK	3@3	15	-110	22.73
			QPSK	12@0	15	-110	21.43
20501	0	834.1	BPSK	1@0	3.75	-110	23.26
			BPSK	1@47	3.75	-110	23.27
			QPSK	1@0	15	-110	23.42
			QPSK	1@11	15	-110	23.34
			QPSK	3@3	15	-110	23.65
			QPSK	12@0	15	-110	23.15
20648	0	848.8	BPSK	1@47	3.75	-110	22.30
			QPSK	1@11	15	-110	22.39
			QPSK	3@3	15	-110	22.66
			QPSK	12@0	15	-110	21.59

LTE Band 26							
Stand-alone							
N _{UL}	M _{UL}	Frequency of Uplink (MHz)	Test Configuration Initial of Power			EUT	
			Modulation	N _{tones}	Sub-carrier Spacing (kHz)	Cell Power (dBm/15 kHz)	Power (dBm)
26792	0	824.2	BPSK	1@0	3.75	-110	22.81
			BPSK	1@0	15	-110	22.83
			QPSK	1@0	3.75	-110	22.81
			QPSK	1@0	15	-110	22.83
			QPSK	3@3	15	-110	22.93
			QPSK	12@0	15	-110	21.79
26915	0	836.5	BPSK	1@0	3.75	-110	23.17
			BPSK	1@0	15	-110	23.19
			BPSK	1@47	3.75	-110	23.16
			QPSK	1@0	3.75	-110	23.2
			QPSK	1@0	15	-110	23.21
			QPSK	1@11	15	-110	23.22
			QPSK	3@3	15	-110	23.36
			QPSK	12@0	15	-110	22.98
27038	0	848.8	BPSK	1@47	3.75	-110	21.76
			BPSK	1@47	15	-110	21.78
			QPSK	1@11	3.75	-110	21.74
			QPSK	1@11	15	-110	21.77
			QPSK	3@3	15	-110	21.94
			QPSK	12@0	15	-110	21.63

LTE Band 26							
In-Band	BW (MHz): 3						
N _{UL}	M _{UL}	Frequency of Uplink (MHz)	Test Configuration Initial of Power			EUT	
			Modulation	N _{tones}	Sub-carrier Spacing (kHz)	Cell Power (dBm/15 kHz)	Power (dBm)
26797	0	824.7	BPSK	1@0	3.75	-110	22.65
			QPSK	1@0	15	-110	22.69
			QPSK	3@3	15	-110	22.81
			QPSK	12@0	15	-110	21.66
26906	0	835.6	BPSK	1@0	3.75	-110	23.01
			BPSK	1@47	3.75	-110	23.03
			QPSK	1@0	15	-110	23.12
			QPSK	1@11	15	-110	23.12
			QPSK	3@3	15	-110	23.23
			QPSK	12@0	15	-110	22.89
27033	0	848.3	BPSK	1@47	3.75	-110	21.63
			QPSK	1@11	15	-110	21.63
			QPSK	3@3	15	-110	21.83
			QPSK	12@0	15	-110	21.47

LTE Band 26							
In-Band	BW (MHz): 10	NB-IoT PRB: 30	Test Configuration Initial of Power			EUT	
N _{UL}	M _{UL}	Frequency of Uplink (MHz)	Modulation	N _{tones}	Sub-carrier Spacing (kHz)	Cell Power (dBm/15 kHz)	Power (dBm)
26851	-2	830.09	BPSK	1@0	3.75	-110	22.67
			QPSK	1@0	15	-110	22.71
			QPSK	3@3	15	-110	22.77
			QPSK	12@0	15	-110	21.63
26925	-2	837.49	BPSK	1@0	3.75	-110	23.06
			BPSK	1@47	3.75	-110	23.00
			QPSK	1@0	15	-110	23.11
			QPSK	1@11	15	-110	23.10
			QPSK	3@3	15	-110	23.24
			QPSK	12@0	15	-110	22.86
26999	-2	844.89	BPSK	1@47	3.75	-110	21.63
			QPSK	1@11	15	-110	21.66
			QPSK	3@3	15	-110	21.82
			QPSK	12@0	15	-110	21.49

LTE Band 26							
In-Band	BW (MHz): 10	NB-IoT PRB: 35	Test Configuration Initial of Power			EUT	
N _{UL}	M _{UL}	Frequency of Uplink (MHz)	Modulation	N _{tones}	Sub-carrier Spacing (kHz)	Cell Power (dBm/15 kHz)	Power (dBm)
26860	-2	830.99	BPSK	1@0	3.75	-110	22.68
			QPSK	1@0	15	-110	22.70
			QPSK	3@3	15	-110	22.78
			QPSK	12@0	15	-110	21.68
26934	-2	838.39	BPSK	1@0	3.75	-110	23.03
			BPSK	1@47	3.75	-110	23.07
			QPSK	1@0	15	-110	23.08
			QPSK	1@11	15	-110	23.07
			QPSK	3@3	15	-110	23.27
			QPSK	12@0	15	-110	22.82
27008	-2	845.79	BPSK	1@47	3.75	-110	21.66
			QPSK	1@11	15	-110	21.63
			QPSK	3@3	15	-110	21.79
			QPSK	12@0	15	-110	21.53

LTE Band 26							
Guard-Band	BW (MHz): 5						
N _{UL}	M _{UL}	Frequency of Uplink (MHz)	Test Configuration Initial of Power			EUT	
			Modulation	N _{tones}	Sub-carrier Spacing (kHz)	Cell Power (dBm/15 kHz)	Power (dBm)
26792	0	824.2	BPSK	1@0	3.75	-110	22.69
			QPSK	1@0	15	-110	22.72
			QPSK	3@3	15	-110	22.82
			QPSK	12@0	15	-110	21.69
26891	0	834.1	BPSK	1@0	3.75	-110	23.02
			BPSK	1@47	3.75	-110	23.04
			QPSK	1@0	15	-110	23.10
			QPSK	1@11	15	-110	23.13
			QPSK	3@3	15	-110	23.25
			QPSK	12@0	15	-110	22.88
27038	0	848.8	BPSK	1@47	3.75	-110	21.66
			QPSK	1@11	15	-110	21.68
			QPSK	3@3	15	-110	21.83
			QPSK	12@0	15	-110	21.47

ERP Power (dBm)

Cat-M1

LTE Band 5							
Channel Bandwidth: 1.4 MHz / QPSK							
Plane	Channel	Frequency (MHz)	Reading (dBm)	Correction Factor (dB)	ERP (dBm)	ERP (mW)	Polarization (H/V)
X	20407	824.7	-7.37	32.62	23.10	204.17	H
	20525	836.5	-7.08	32.52	23.29	213.30	
	20643	848.3	-7.43	32.65	23.07	202.77	
	20407	824.7	-12.92	32.76	17.69	58.75	V
	20525	836.5	-12.36	32.39	17.88	61.38	
	20643	848.3	-12.56	32.54	17.83	60.67	
Channel Bandwidth: 1.4 MHz / 16QAM							
X	20407	824.7	-10.31	32.62	20.16	103.75	H
	20525	836.5	-10.02	32.52	20.35	108.39	
	20643	848.3	-10.37	32.65	20.13	103.04	
	20407	824.7	-15.86	32.76	14.75	29.85	V
	20525	836.5	-15.30	32.39	14.94	31.19	
	20643	848.3	-15.50	32.54	14.89	30.83	

Note: ERP (dBm) = Reading (dBm) + Correction Factor (dB) – 2.15

LTE Band 5							
Channel Bandwidth: 3 MHz / QPSK							
Plane	Channel	Frequency (MHz)	Reading (dBm)	Correction Factor (dB)	ERP (dBm)	ERP (mW)	Polarization (H/V)
X	20415	825.5	-7.13	32.62	23.34	215.77	H
	20525	836.5	-6.84	32.52	23.53	225.42	
	20635	847.5	-7.19	32.65	23.31	214.29	
	20415	825.5	-12.68	32.76	17.93	62.09	V
	20525	836.5	-12.12	32.39	18.12	64.86	
	20635	847.5	-12.32	32.54	18.07	64.12	
Channel Bandwidth: 3 MHz / 16QAM							
X	20415	825.5	-8.17	32.62	22.30	169.82	H
	20525	836.5	-7.88	32.52	22.49	177.42	
	20635	847.5	-8.23	32.65	22.27	168.66	
	20415	825.5	-13.72	32.76	16.89	48.87	V
	20525	836.5	-13.16	32.39	17.08	51.05	
	20635	847.5	-13.36	32.54	17.03	50.47	

Note: ERP (dBm) = Reading (dBm) + Correction Factor (dB) – 2.15

LTE Band 5							
Channel Bandwidth: 5 MHz / QPSK							
Plane	Channel	Frequency (MHz)	Reading (dBm)	Correction Factor (dB)	ERP (dBm)	ERP (mW)	Polarization (H/V)
X	20425	826.5	-6.87	32.62	23.60	229.09	H
	20525	836.5	-6.58	32.52	23.79	239.33	
	20625	846.5	-6.93	32.65	23.57	227.51	
	20425	826.5	-12.42	32.76	18.19	65.92	V
	20525	836.5	-11.86	32.39	18.38	68.87	
	20625	846.5	-12.06	32.54	18.33	68.08	
Channel Bandwidth: 5 MHz / 16QAM							
X	20425	826.5	-7.91	32.62	22.56	180.30	H
	20525	836.5	-7.62	32.52	22.75	188.36	
	20625	846.5	-7.97	32.65	22.53	179.06	
	20425	826.5	-13.46	32.76	17.15	51.88	V
	20525	836.5	-12.90	32.39	17.34	54.20	
	20625	846.5	-13.10	32.54	17.29	53.58	

Note: ERP (dBm) = Reading (dBm) + Correction Factor (dB) – 2.15

LTE Band 5							
Channel Bandwidth: 10 MHz / QPSK							
Plane	Channel	Frequency (MHz)	Reading (dBm)	Correction Factor (dB)	ERP (dBm)	ERP (mW)	Polarization (H/V)
X	20450	829.0	-6.63	32.62	23.84	242.10	H
	20525	836.5	-6.34	32.52	24.03	252.93	
	20600	844.0	-6.69	32.65	23.81	240.44	
	20450	829.0	-12.18	32.76	18.43	69.66	V
	20525	836.5	-11.62	32.39	18.62	72.78	
	20600	844.0	-11.82	32.54	18.57	71.94	
Channel Bandwidth: 10 MHz / 16QAM							
X	20425	826.5	-7.66	32.62	22.81	190.99	H
	20525	836.5	-7.37	32.52	23.00	199.53	
	20625	846.5	-7.72	32.65	22.78	189.67	
	20425	826.5	-13.21	32.76	17.40	54.95	V
	20525	836.5	-12.65	32.39	17.59	57.41	
	20625	846.5	-12.85	32.54	17.54	56.75	

Note: ERP (dBm) = Reading (dBm) + Correction Factor (dB) – 2.15

LTE Band 26							
Channel Bandwidth: 1.4 MHz / QPSK							
Plane	Channel	Frequency (MHz)	Reading (dBm)	Correction Factor (dB)	ERP (dBm)	ERP (mW)	Polarization (H/V)
X	26797	824.7	-7.92	32.62	22.55	179.89	H
	26915	836.5	-7.88	32.52	22.49	177.42	
	27033	848.3	-8.05	32.65	22.45	175.79	
	26797	824.7	-13.14	32.76	17.47	55.85	V
	26915	836.5	-12.86	32.39	17.38	54.70	
	27033	848.3	-13.15	32.54	17.24	52.97	
Channel Bandwidth: 1.4 MHz / 16QAM							
X	26797	824.7	-8.93	32.62	21.54	142.56	H
	26915	836.5	-8.89	32.52	21.48	140.60	
	27033	848.3	-9.06	32.65	21.44	139.32	
	26797	824.7	-14.15	32.76	16.46	44.26	V
	26915	836.5	-13.87	32.39	16.37	43.35	
	27033	848.3	-14.16	32.54	16.23	41.98	

Note: ERP (dBm) = Reading (dBm) + Correction Factor (dB) – 2.15

LTE Band 26							
Channel Bandwidth: 3 MHz / QPSK							
Plane	Channel	Frequency (MHz)	Reading (dBm)	Correction Factor (dB)	ERP (dBm)	ERP (mW)	Polarization (H/V)
X	26805	825.5	-7.64	32.62	22.83	191.87	H
	26915	836.5	-7.60	32.52	22.77	189.23	
	27025	847.5	-7.77	32.65	22.73	187.50	
	26805	825.5	-12.86	32.76	17.75	59.57	V
	26915	836.5	-12.58	32.39	17.66	58.34	
	27025	847.5	-12.87	32.54	17.52	56.49	
Channel Bandwidth: 3 MHz / 16QAM							
X	26805	825.5	-8.66	32.62	21.81	151.71	H
	26915	836.5	-8.62	32.52	21.75	149.62	
	27025	847.5	-8.79	32.65	21.71	148.25	
	26805	825.5	-13.88	32.76	16.73	47.10	V
	26915	836.5	-13.60	32.39	16.64	46.13	
	27025	847.5	-13.89	32.54	16.50	44.67	

Note: ERP (dBm) = Reading (dBm) + Correction Factor (dB) – 2.15

LTE Band 26							
Channel Bandwidth: 5 MHz / QPSK							
Plane	Channel	Frequency (MHz)	Reading (dBm)	Correction Factor (dB)	ERP (dBm)	ERP (mW)	Polarization (H/V)
X	26815	826.5	-7.38	32.62	23.09	203.70	H
	26915	836.5	-7.34	32.52	23.03	200.91	
	27015	846.5	-7.51	32.65	22.99	199.07	
	26815	826.5	-12.60	32.76	18.01	63.24	V
	26919	836.5	-12.32	32.39	17.92	61.94	
	27015	846.5	-12.61	32.54	17.78	59.98	
Channel Bandwidth: 5 MHz / 16QAM							
X	26815	826.5	-8.42	32.62	22.05	160.32	H
	26915	836.5	-8.38	32.52	21.99	158.12	
	27015	846.5	-8.55	32.65	21.95	156.68	
	26815	826.5	-13.64	32.76	16.97	49.77	V
	26919	836.5	-13.36	32.39	16.88	48.75	
	27015	846.5	-13.65	32.54	16.74	47.21	

Note: ERP (dBm) = Reading (dBm) + Correction Factor (dB) – 2.15

LTE Band 26							
Channel Bandwidth: 10 MHz / QPSK							
Plane	Channel	Frequency (MHz)	Reading (dBm)	Correction Factor (dB)	ERP (dBm)	ERP (mW)	Polarization (H/V)
X	26840	829.0	-7.11	32.62	23.36	216.77	H
	26915	836.5	-7.07	32.52	23.30	213.80	
	26990	844.0	-7.24	32.65	23.26	211.84	
	26840	829.0	-12.33	32.76	18.28	67.30	V
	26919	836.5	-12.05	32.39	18.19	65.92	
	26990	844.0	-12.34	32.54	18.05	63.83	
Channel Bandwidth: 10 MHz / 16QAM							
X	26840	829.0	-8.16	32.62	22.31	170.22	H
	26915	836.5	-8.12	32.52	22.25	167.88	
	26990	844.0	-8.29	32.65	22.21	166.34	
	26840	829.0	-13.38	32.76	17.23	52.84	V
	26919	836.5	-13.10	32.39	17.14	51.76	
	26990	844.0	-13.39	32.54	17.00	50.12	

Note: ERP (dBm) = Reading (dBm) + Correction Factor (dB) – 2.15

LTE Band 26							
Channel Bandwidth: 15 MHz / QPSK							
Plane	Channel	Frequency (MHz)	Reading (dBm)	Correction Factor (dB)	ERP (dBm)	ERP (mW)	Polarization (H/V)
X	26865	831.5	-6.87	32.62	23.60	229.09	H
	26915	836.5	-6.83	32.52	23.54	225.94	
	26965	841.5	-7.00	32.65	23.50	223.87	
	26865	831.5	-12.09	32.76	18.52	71.12	V
	26915	836.5	-11.81	32.39	18.43	69.66	
	26965	841.5	-12.10	32.54	18.29	67.45	
Channel Bandwidth: 15 MHz / 16QAM							
X	26865	831.5	-7.90	32.62	22.57	180.72	H
	26915	836.5	-7.86	32.52	22.51	178.24	
	26965	841.5	-8.03	32.65	22.47	176.60	
	26865	831.5	-13.12	32.76	17.49	56.10	V
	26915	836.5	-12.84	32.39	17.40	54.95	
	26965	841.5	-13.13	32.54	17.26	53.21	

Note: ERP (dBm) = Reading (dBm) + Correction Factor (dB) – 2.15

NB-IoT

LTE Band 5							
Modulation: BPSK							
Plane	Channel	Frequency (MHz)	Reading (dBm)	Correction Factor (dB)	ERP (dBm)	ERP (mW)	Polarization (H/V)
X	20401	824.1	-8.72	32.62	21.75	149.62	H
	20525	836.5	-7.73	32.52	22.64	183.65	
	20649	848.9	-8.85	32.65	21.65	146.22	
	20401	824.1	-13.28	32.76	17.33	54.08	V
	20525	836.5	-12.57	32.39	17.67	58.48	
	20649	848.9	-13.12	32.54	17.27	53.33	
Modulation: QPSK							
X	20401	824.1	-7.74	32.62	22.73	187.50	H
	20525	836.5	-6.75	32.52	23.62	230.14	
	20649	848.9	-7.87	32.65	22.63	183.23	
	20401	824.1	-12.30	32.76	18.31	67.76	V
	20525	836.5	-11.59	32.39	18.65	73.28	
	20649	848.9	-12.14	32.54	18.25	66.83	

Note: ERP (dBm) = Reading (dBm) + Correction Factor (dB) – 2.15

LTE Band 26							
Modulation: BPSK							
Plane	Channel	Frequency (MHz)	Reading (dBm)	Correction Factor (dB)	ERP (dBm)	ERP (mW)	Polarization (H/V)
X	26791	824.1	-8.72	32.62	21.75	149.62	H
	26915	836.5	-8.19	32.52	22.18	165.20	
	27039	848.9	-9.76	32.65	20.74	118.58	
	26791	824.1	-13.97	32.76	16.64	46.13	V
	26915	836.5	-13.09	32.39	17.15	51.88	
	27039	848.9	-14.05	32.54	16.34	43.05	
Modulation: QPSK							
X	26791	824.1	-7.71	32.62	22.76	188.80	H
	26915	836.5	-7.18	32.52	23.19	208.45	
	27039	848.9	-8.75	32.65	21.75	149.62	
	26791	824.1	-12.96	32.76	17.65	58.21	V
	26915	836.5	-12.08	32.39	18.16	65.46	
	27039	848.9	-13.04	32.54	17.35	54.33	

Note: ERP (dBm) = Reading (dBm) + Correction Factor (dB) – 2.15

4.2 Modulation Characteristics Measurement

4.2.1 Limits of Modulation Characteristics

N/A

4.2.2 Test Setup



4.2.3 Test Procedure

Connect the EUT to Communication Simulator via the antenna connector. The frequency band is set as EUT supported Modulation and Channels, the EUT output is matched with 50 ohm load, the waveform quality and constellation of the EUT was tested.

4.2.4 Test Results

Cat-M1

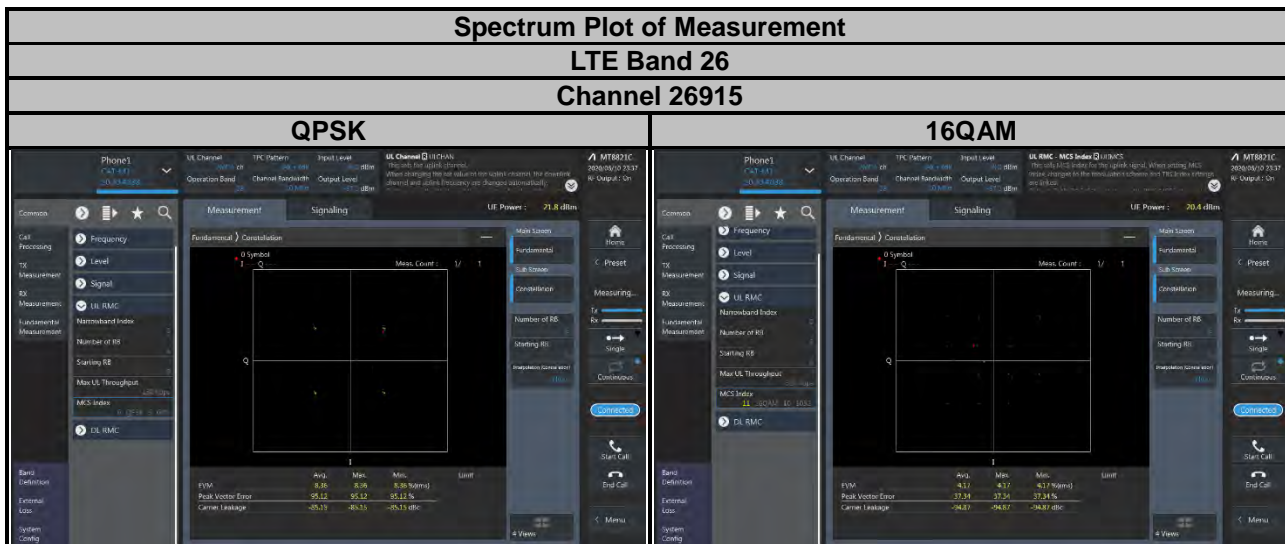
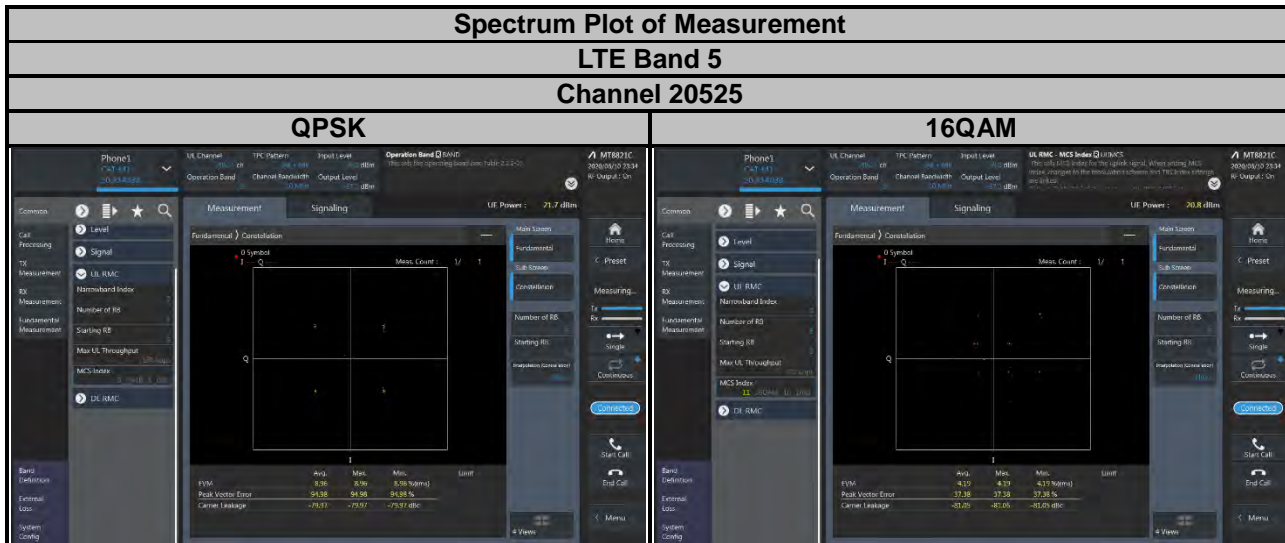

NB-IoT

Spectrum Plot of Measurement
LTE Band 5
Channel 20525

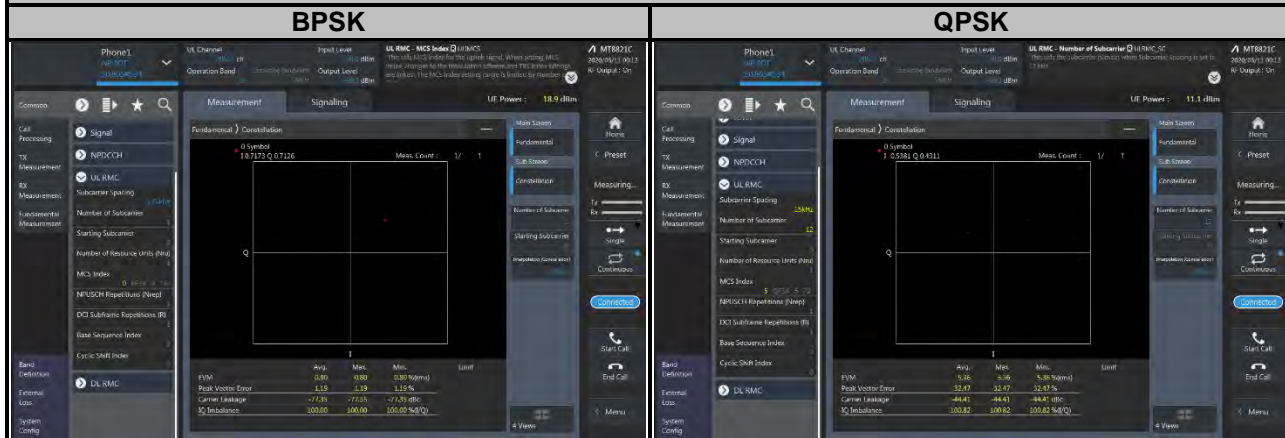

Spectrum Plot of Measurement
LTE Band 26
Channel 26915

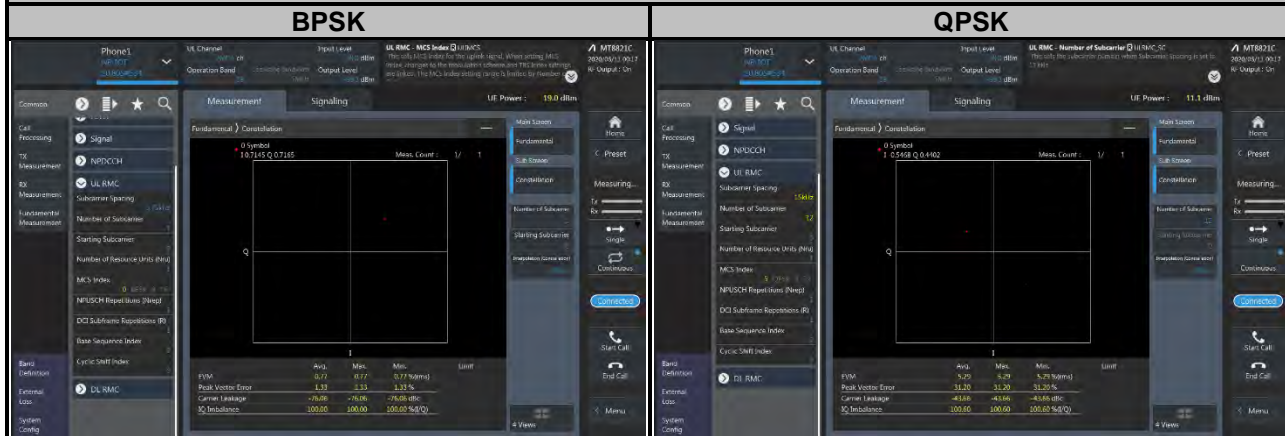

4.3 Frequency Stability Measurement

4.3.1 Limits of Frequency Stability Measurement

1.5 ppm is for base and fixed station. 2.5 ppm is for mobile station.

4.3.2 Test Procedure

- a. Device is placed at the oven room. The oven room could control the temperatures and humidity. Power warm up is at least 15 min and power applied should perform before recording frequency error.
- b. EUT is connected the external power supply to control the DC input power. The test voltage range is from minimum to maximum working voltage. Each step shall be record the frequency error rate.
- c. The temperature range step is 10 degrees in this test items. All temperature levels shall be hold the ± 0.5 °C during the measurement testing. The each temperature step shall be at least 0.5 hours, consider the EUT could be test under the stability condition.

NOTE: The frequency error was recorded frequency error from the communication simulator.

4.3.3 Test Setup

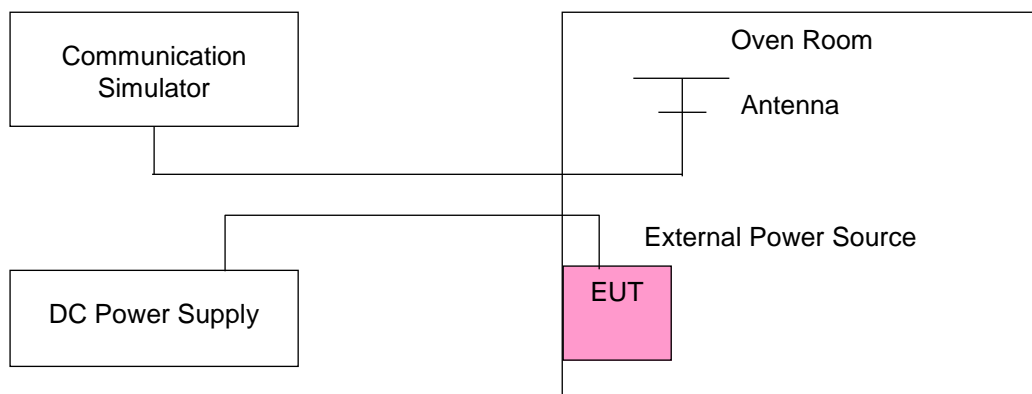

4.3.4 Test Results

Cat-M1

Voltage (Volts)	LTE Band 5				Limit (ppm)
	Channel Bandwidth: 1.4 MHz				
	Low Channel		High Channel		
	Frequency (MHz)	Frequency Error (ppm)	Frequency (MHz)	Frequency Error (ppm)	
10.2	824.700002	0.002	848.300001	0.001	2.5
12	824.700001	0.001	848.300001	0.001	2.5
13.8	824.700003	0.003	848.300003	0.003	2.5

Note: The fixture defined the normal working voltage of the adapter is from 10.2 Vdc to 13.8 Vdc.

Frequency Error vs. Temperature

Temp. (°C)	LTE Band 5				Limit (ppm)
	Channel Bandwidth: 1.4 MHz				
	Low Channel		High Channel		
	Frequency (MHz)	Frequency Error (ppm)	Frequency (MHz)	Frequency Error (ppm)	
-30	824.700003	0.004	848.300001	0.001	2.5
-20	824.700002	0.002	848.300002	0.002	2.5
-10	824.700002	0.002	848.300003	0.004	2.5
0	824.700003	0.003	848.300001	0.002	2.5
10	824.700003	0.004	848.300001	0.001	2.5
20	824.699999	-0.001	848.299997	-0.004	2.5
30	824.699997	-0.003	848.299997	-0.004	2.5
40	824.699996	-0.004	848.299999	-0.001	2.5
50	824.699999	-0.001	848.299996	-0.005	2.5
60	824.699999	-0.002	848.299996	-0.004	2.5
70	824.699997	-0.004	848.299998	-0.003	2.5
80	824.699998	-0.002	848.299997	-0.003	2.5
85	824.699997	-0.004	848.299998	-0.003	2.5

Frequency Error vs. Voltage

Voltage (Volts)	LTE Band 5				Limit (ppm)
	Channel Bandwidth: 3 MHz				
	Low Channel		High Channel		
	Frequency (MHz)	Frequency Error (ppm)	Frequency (MHz)	Frequency Error (ppm)	
10.2	825.500003	0.004	847.500003	0.004	2.5
12	825.500003	0.004	847.500003	0.003	2.5
13.8	825.500003	0.004	847.500004	0.005	2.5

Note: The fixture defined the normal working voltage of the adapter is from 10.2 Vdc to 13.8 Vdc.

Frequency Error vs. Temperature

Temp. (°C)	LTE Band 5				Limit (ppm)
	Channel Bandwidth: 3 MHz				
	Low Channel		High Channel		
	Frequency (MHz)	Frequency Error (ppm)	Frequency (MHz)	Frequency Error (ppm)	
-30	825.500004	0.005	847.500003	0.004	2.5
-20	825.500004	0.005	847.500002	0.003	2.5
-10	825.500004	0.004	847.500003	0.003	2.5
0	825.500001	0.001	847.500002	0.003	2.5
10	825.500003	0.004	847.500002	0.002	2.5
20	825.499996	-0.004	847.499998	-0.002	2.5
30	825.499998	-0.002	847.499996	-0.005	2.5
40	825.499997	-0.003	847.499997	-0.004	2.5
50	825.499997	-0.004	847.499997	-0.003	2.5
60	825.499996	-0.005	847.499998	-0.003	2.5
70	825.499996	-0.005	847.499997	-0.004	2.5
80	825.499998	-0.002	847.499997	-0.004	2.5
85	825.499998	-0.003	847.499996	-0.004	2.5

Frequency Error vs. Voltage

Voltage (Volts)	LTE Band 5				Limit (ppm)
	Channel Bandwidth: 5 MHz				
	Low Channel		High Channel		
	Frequency (MHz)	Frequency Error (ppm)	Frequency (MHz)	Frequency Error (ppm)	
10.2	826.500001	0.001	846.500003	0.003	2.5
12	826.500002	0.002	846.500003	0.003	2.5
13.8	826.500003	0.004	846.500003	0.003	2.5

Note: The fixture defined the normal working voltage of the adapter is from 10.2 Vdc to 13.8 Vdc.

Frequency Error vs. Temperature

Temp. (°C)	LTE Band 5				Limit (ppm)
	Channel Bandwidth: 5 MHz				
	Low Channel		High Channel		
	Frequency (MHz)	Frequency Error (ppm)	Frequency (MHz)	Frequency Error (ppm)	
-30	826.500001	0.001	846.500003	0.004	2.5
-20	826.500002	0.002	846.500003	0.004	2.5
-10	826.500004	0.005	846.500003	0.004	2.5
0	826.500002	0.002	846.500002	0.002	2.5
10	826.500001	0.001	846.500001	0.002	2.5
20	826.499999	-0.001	846.499997	-0.004	2.5
30	826.499996	-0.004	846.499996	-0.004	2.5
40	826.499997	-0.004	846.499997	-0.004	2.5
50	826.499999	-0.001	846.499997	-0.003	2.5
60	826.499999	-0.002	846.499997	-0.003	2.5
70	826.499998	-0.002	846.499999	-0.002	2.5
80	826.499996	-0.005	846.499997	-0.003	2.5
85	826.499999	-0.001	846.499998	-0.002	2.5

Frequency Error vs. Voltage

Voltage (Volts)	LTE Band 5				Limit (ppm)
	Channel Bandwidth: 10 MHz				
	Low Channel		High Channel		
	Frequency (MHz)	Frequency Error (ppm)	Frequency (MHz)	Frequency Error (ppm)	
10.2	829.000003	0.003	844.000001	0.001	2.5
12	829.000002	0.002	844.000002	0.002	2.5
13.8	829.000002	0.003	844.000001	0.002	2.5

Note: The fixture defined the normal working voltage of the adapter is from 10.2 Vdc to 13.8 Vdc.

Frequency Error vs. Temperature

Temp. (°C)	LTE Band 5				Limit (ppm)
	Channel Bandwidth: 10 MHz				
	Low Channel		High Channel		
	Frequency (MHz)	Frequency Error (ppm)	Frequency (MHz)	Frequency Error (ppm)	
-30	829.000004	0.004	844.000002	0.003	2.5
-20	829.000003	0.004	844.000002	0.002	2.5
-10	829.000003	0.003	844.000003	0.003	2.5
0	829.000003	0.004	844.000001	0.001	2.5
10	829.000001	0.001	844.000002	0.003	2.5
20	828.999996	-0.005	843.999997	-0.003	2.5
30	828.999999	-0.001	843.999996	-0.004	2.5
40	828.999997	-0.004	843.999999	-0.001	2.5
50	828.999999	-0.001	843.999999	-0.002	2.5
60	828.999999	-0.002	843.999999	-0.001	2.5
70	828.999999	-0.001	843.999996	-0.005	2.5
80	828.999997	-0.004	843.999999	-0.002	2.5
85	828.999998	-0.002	843.999998	-0.003	2.5

Frequency Error vs. Voltage

Voltage (Volts)	LTE Band 26				Limit (ppm)
	Channel Bandwidth: 1.4 MHz				
	Low Channel		High Channel		
	Frequency (MHz)	Frequency Error (ppm)	Frequency (MHz)	Frequency Error (ppm)	
10.2	824.700004	0.004	848.300000	0.004	2.5
12	824.700004	0.005	848.300000	0.003	2.5
13.8	824.700004	0.005	848.300000	0.002	2.5

Note: The fixture defined the normal working voltage of the adapter is from 10.2 Vdc to 13.8 Vdc.

Frequency Error vs. Temperature

Temp. (°C)	LTE Band 26				Limit (ppm)
	Channel Bandwidth: 1.4 MHz				
	Low Channel		High Channel		
	Frequency (MHz)	Frequency Error (ppm)	Frequency (MHz)	Frequency Error (ppm)	
-30	824.700002	0.003	848.300000	0.004	2.5
-20	824.700003	0.003	848.300000	0.004	2.5
-10	824.700002	0.003	848.300000	0.004	2.5
0	824.700001	0.001	848.300000	0.004	2.5
10	824.700003	0.004	848.300000	0.001	2.5
20	824.699996	-0.005	848.300000	-0.004	2.5
30	824.699997	-0.003	848.300000	-0.001	2.5
40	824.699997	-0.003	848.300000	-0.002	2.5
50	824.699998	-0.003	848.300000	-0.002	2.5
60	824.699999	-0.001	848.300000	-0.003	2.5
70	824.699999	-0.001	848.300000	-0.002	2.5
80	824.699999	-0.002	848.300000	-0.004	2.5
85	824.699998	-0.003	848.300000	-0.002	2.5

Frequency Error vs. Voltage

Voltage (Volts)	LTE Band 26				Limit (ppm)
	Channel Bandwidth: 3 MHz				
	Low Channel		High Channel		
	Frequency (MHz)	Frequency Error (ppm)	Frequency (MHz)	Frequency Error (ppm)	
10.2	825.500002	0.002	847.500000	0.002	2.5
12	825.500001	0.001	847.500000	0.002	2.5
13.8	825.500002	0.002	847.500000	0.001	2.5

Note: The fixture defined the normal working voltage of the adapter is from 10.2 Vdc to 13.8 Vdc.

Frequency Error vs. Temperature

Temp. (°C)	LTE Band 26				Limit (ppm)
	Channel Bandwidth: 3 MHz				
	Low Channel		High Channel		
	Frequency (MHz)	Frequency Error (ppm)	Frequency (MHz)	Frequency Error (ppm)	
-30	825.500002	0.003	847.500000	0.004	2.5
-20	825.500002	0.002	847.500000	0.002	2.5
-10	825.500003	0.003	847.500000	0.003	2.5
0	825.500002	0.002	847.500000	0.003	2.5
10	825.500002	0.002	847.500000	0.003	2.5
20	825.499998	-0.003	847.500000	-0.004	2.5
30	825.499998	-0.002	847.500000	-0.002	2.5
40	825.499996	-0.004	847.500000	-0.004	2.5
50	825.499997	-0.004	847.500000	-0.004	2.5
60	825.499998	-0.002	847.500000	-0.001	2.5
70	825.499997	-0.003	847.500000	-0.002	2.5
50	825.499997	-0.004	847.500000	-0.003	2.5
85	825.499997	-0.003	847.500000	-0.001	2.5

Frequency Error vs. Voltage

Voltage (Volts)	LTE Band 26				Limit (ppm)
	Channel Bandwidth: 5 MHz				
	Low Channel		High Channel		
	Frequency (MHz)	Frequency Error (ppm)	Frequency (MHz)	Frequency Error (ppm)	
10.2	826.500001	0.002	846.500000	0.002	2.5
12	826.500003	0.003	846.500000	0.005	2.5
13.8	826.500003	0.004	846.500000	0.004	2.5

Note: The fixture defined the normal working voltage of the adapter is from 10.2 Vdc to 13.8 Vdc.

Frequency Error vs. Temperature

Temp. (°C)	LTE Band 26				Limit (ppm)
	Channel Bandwidth: 5 MHz				
	Low Channel		High Channel		
	Frequency (MHz)	Frequency Error (ppm)	Frequency (MHz)	Frequency Error (ppm)	
-30	826.500002	0.002	846.500000	0.004	2.5
-20	826.500004	0.004	846.500000	0.003	2.5
-10	826.500002	0.002	846.500000	0.003	2.5
0	826.500001	0.001	846.500000	0.002	2.5
10	826.500004	0.005	846.500000	0.003	2.5
20	826.499997	-0.004	846.500000	-0.005	2.5
30	826.499999	-0.001	846.500000	-0.003	2.5
40	826.499997	-0.004	846.500000	-0.003	2.5
50	826.499997	-0.004	846.500000	-0.002	2.5
60	826.499998	-0.003	846.500000	-0.004	2.5
70	826.499999	-0.001	846.500000	-0.003	2.5
50	826.499997	-0.004	846.500000	-0.004	2.5
85	826.499997	-0.004	846.500000	-0.002	2.5

Frequency Error vs. Voltage

Voltage (Volts)	LTE Band 26				Limit (ppm)
	Channel Bandwidth: 10 MHz				
	Low Channel		High Channel		
	Frequency (MHz)	Frequency Error (ppm)	Frequency (MHz)	Frequency Error (ppm)	
10.2	829.000003	0.004	844.000000	0.003	2.5
12	829.000004	0.004	844.000000	0.003	2.5
13.8	829.000002	0.002	844.000000	0.003	2.5

Note: The fixture defined the normal working voltage of the adapter is from 10.2 Vdc to 13.8 Vdc.

Frequency Error vs. Temperature

Temp. (°C)	LTE Band 26				Limit (ppm)
	Channel Bandwidth: 10 MHz				
	Low Channel		High Channel		
	Frequency (MHz)	Frequency Error (ppm)	Frequency (MHz)	Frequency Error (ppm)	
-30	829.000003	0.004	844.000000	0.004	2.5
-20	829.000003	0.003	844.000000	0.005	2.5
-10	829.000003	0.003	844.000000	0.004	2.5
0	829.000002	0.002	844.000000	0.002	2.5
10	829.000002	0.003	844.000000	0.004	2.5
20	828.999997	-0.003	844.000000	-0.003	2.5
30	828.999996	-0.005	844.000000	-0.004	2.5
40	828.999997	-0.003	844.000000	-0.004	2.5
50	828.999996	-0.004	844.000000	-0.003	2.5
60	828.999997	-0.003	844.000000	-0.004	2.5
70	828.999999	-0.002	844.000000	-0.003	2.5
50	828.999998	-0.003	844.000000	-0.004	2.5
85	828.999996	-0.004	844.000000	-0.004	2.5

Frequency Error vs. Voltage

Voltage (Volts)	LTE Band 26				Limit (ppm)
	Channel Bandwidth: 15 MHz				
	Low Channel		High Channel		
	Frequency (MHz)	Frequency Error (ppm)	Frequency (MHz)	Frequency Error (ppm)	
10.2	831.500003	0.003	841.500000	0.003	2.5
12	831.500001	0.001	841.500000	0.004	2.5
13.8	831.500002	0.002	841.500000	0.003	2.5

Note: The fixture defined the normal working voltage of the adapter is from 10.2 Vdc to 13.8 Vdc.

Frequency Error vs. Temperature

Temp. (°C)	LTE Band 26				Limit (ppm)
	Channel Bandwidth: 15 MHz				
	Low Channel		High Channel		
	Frequency (MHz)	Frequency Error (ppm)	Frequency (MHz)	Frequency Error (ppm)	
-30	831.500001	0.001	841.500000	0.004	2.5
-20	831.500003	0.003	841.500000	0.005	2.5
-10	831.500003	0.004	841.500000	0.004	2.5
0	831.500003	0.004	841.500000	0.005	2.5
10	831.500002	0.003	841.500000	0.002	2.5
20	831.499997	-0.004	841.500000	-0.002	2.5
30	831.499998	-0.003	841.500000	-0.002	2.5
40	831.499997	-0.003	841.500000	-0.004	2.5
50	831.499998	-0.002	841.500000	-0.002	2.5
60	831.499998	-0.003	841.500000	-0.001	2.5
70	831.499997	-0.004	841.500000	-0.004	2.5
50	831.499999	-0.002	841.500000	-0.005	2.5
85	831.499997	-0.004	841.500000	-0.004	2.5

NB-IoT

Frequency Error vs. Voltage

Voltage (Volts)	LTE Band 5				Limit (ppm)
	Low Channel		High Channel		
	Frequency (MHz)	Frequency Error (ppm)	Frequency (MHz)	Frequency Error (ppm)	
10.2	824.200003	0.003	848.800003	0.004	2.5
12	824.200001	0.002	848.800004	0.004	2.5
13.8	824.200002	0.002	848.800003	0.003	2.5

Note: The fixture defined the normal working voltage of the adapter is from 10.2 Vdc to 13.8 Vdc.

Frequency Error vs. Temperature

Temp. (°C)	LTE Band 5				Limit (ppm)
	Low Channel		High Channel		
	Frequency (MHz)	Frequency Error (ppm)	Frequency (MHz)	Frequency Error (ppm)	
-30	824.200003	0.003	848.800001	0.001	2.5
-20	824.200001	0.002	848.800002	0.003	2.5
-10	824.200002	0.002	848.800003	0.003	2.5
0	824.200002	0.002	848.800003	0.003	2.5
10	824.200004	0.005	848.800004	0.005	2.5
20	824.199997	-0.004	848.799997	-0.004	2.5
30	824.199998	-0.002	848.799997	-0.004	2.5
40	824.199997	-0.004	848.799996	-0.004	2.5
50	824.199996	-0.004	848.799996	-0.005	2.5
60	824.199996	-0.004	848.799999	-0.001	2.5
70	824.199998	-0.002	848.799999	-0.001	2.5
80	824.199998	-0.002	848.799999	-0.002	2.5
85	824.199997	-0.003	848.799997	-0.004	2.5

Frequency Error vs. Voltage

Voltage (Volts)	LTE Band 26				Limit (ppm)
	Low Channel		High Channel		
	Frequency (MHz)	Frequency Error (ppm)	Frequency (MHz)	Frequency Error (ppm)	
10.2	824.200001	0.001	848.800004	0.005	2.5
12	824.200003	0.004	848.800002	0.003	2.5
13.8	824.200003	0.004	848.800002	0.003	2.5

Note: The fixture defined the normal working voltage of the adapter is from 10.2 Vdc to 13.8 Vdc.

Frequency Error vs. Temperature

Temp. (°C)	LTE Band 26				Limit (ppm)
	Low Channel		High Channel		
	Frequency (MHz)	Frequency Error (ppm)	Frequency (MHz)	Frequency Error (ppm)	
-30	824.200002	0.002	848.800002	0.002	2.5
-20	824.200003	0.004	848.800003	0.004	2.5
-10	824.200001	0.002	848.800002	0.003	2.5
0	824.200003	0.003	848.800001	0.001	2.5
10	824.200002	0.002	848.800002	0.003	2.5
20	824.199997	-0.003	848.799998	-0.003	2.5
30	824.199998	-0.003	848.799998	-0.003	2.5
40	824.199999	-0.001	848.799997	-0.003	2.5
50	824.199998	-0.002	848.799997	-0.004	2.5
60	824.199999	-0.001	848.799997	-0.004	2.5
70	824.199998	-0.002	848.799997	-0.004	2.5
80	824.199996	-0.005	848.799998	-0.003	2.5
85	824.199997	-0.003	848.799997	-0.003	2.5

4.4 Occupied Bandwidth Measurement

4.4.1 Test Procedure

The EUT makes a call to the communication simulator. All measurements were done at low, middle and high operational frequency range. The communication simulator station system controlled a EUT to export maximum output power under transmission mode and specific channel frequency. Use OBW measurement function of Spectrum analyzer to measure 99 % occupied bandwidth.

4.4.2 Test Setup

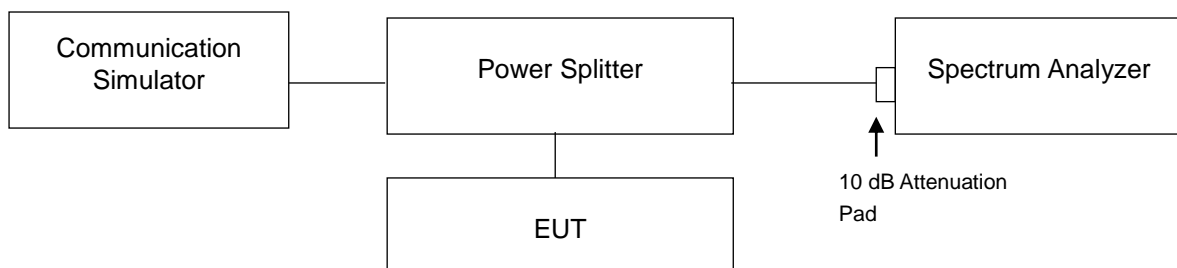

4.4.3 Test Result

Cat-M1

LTE Band 5					
Channel Bandwidth: 1.4 MHz					
Channel	Frequency (MHz)	99 % Occupied Bandwidth (MHz)		26 dB Bandwidth (MHz)	
		QPSK	16QAM	QPSK	16QAM
20407	824.7	1.0715	1.0852	1.245	1.268
20525	836.5	1.0910	1.0818	1.275	1.274
20643	848.3	1.0911	1.0864	1.271	1.261
Channel Bandwidth: 3 MHz					
Channel	Frequency (MHz)	99 % Occupied Bandwidth (MHz)		26 dB Bandwidth (MHz)	
		QPSK	16QAM	QPSK	16QAM
20415	825.5	1.0849	1.0791	1.265	1.268
20525	836.5	1.0926	1.0770	1.269	1.267
20635	847.5	1.0932	1.0793	1.266	1.272

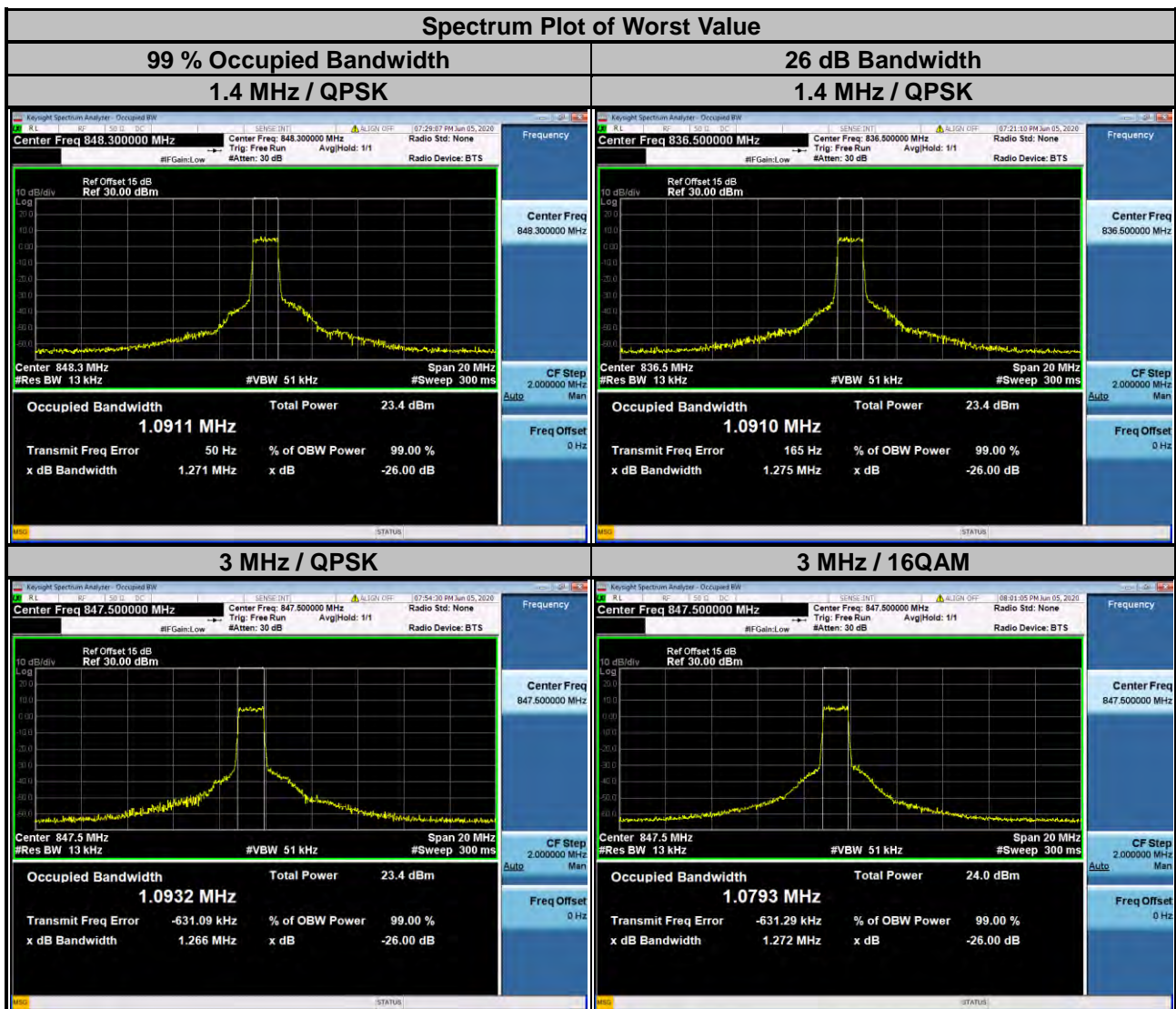

LTE Band 5					
Channel Bandwidth: 5 MHz					
Channel	Frequency (MHz)	99 % Occupied Bandwidth (MHz)		26 dB Bandwidth (MHz)	
		QPSK	16QAM	QPSK	16QAM
20425	826.5	1.0926	1.0859	1.275	1.290
20525	836.5	1.0856	1.0871	1.276	1.299
20625	846.5	1.0869	1.0839	1.268	1.288

Channel Bandwidth: 10 MHz					
Channel	Frequency (MHz)	99 % Occupied Bandwidth (MHz)		26 dB Bandwidth (MHz)	
		QPSK	16QAM	QPSK	16QAM
20450	829.0	1.0902	1.0897	1.273	1.277
20525	836.5	1.0902	1.0879	1.272	1.295
20600	844.0	1.0914	1.0881	1.280	1.283

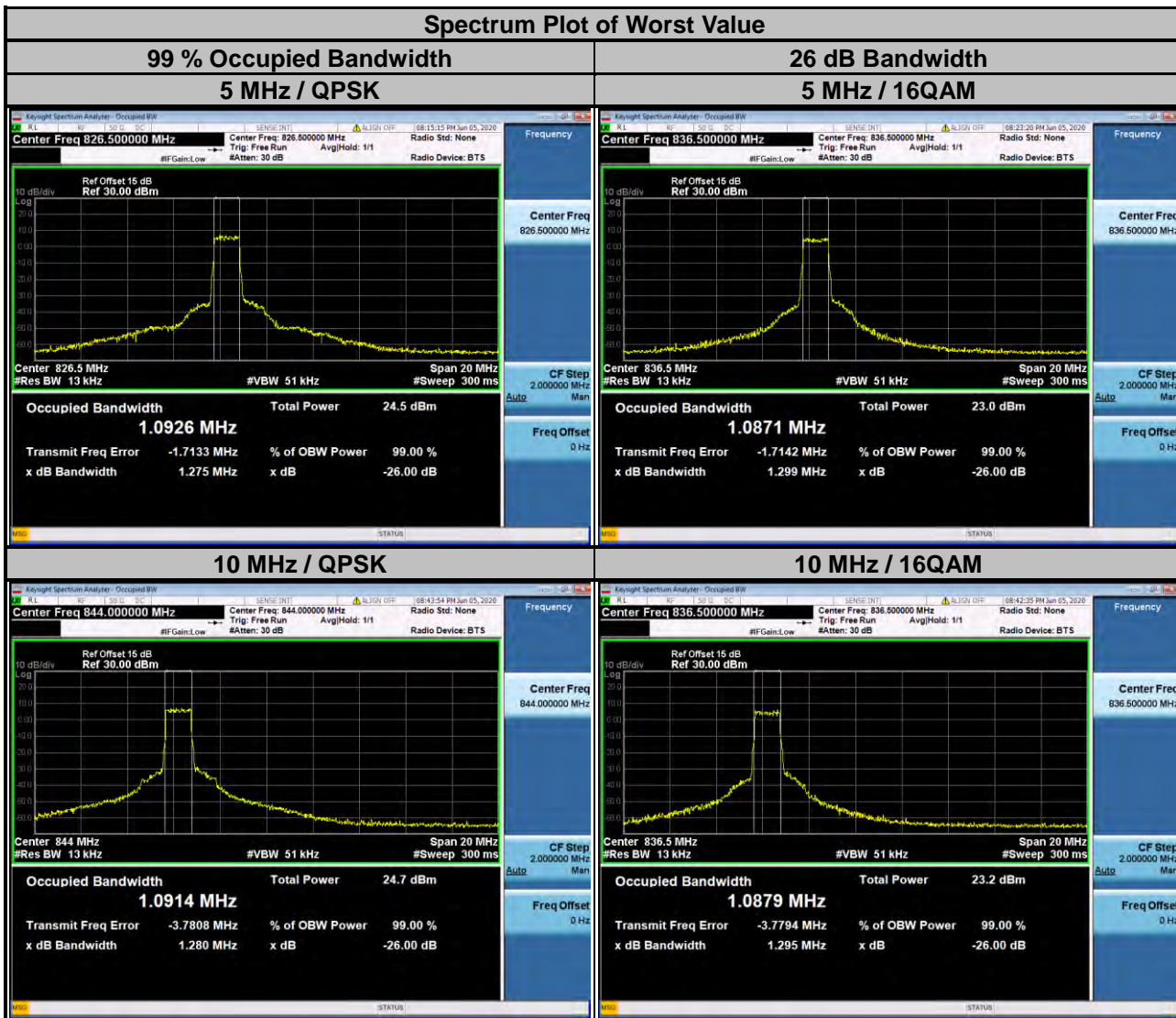

LTE Band 26					
Channel Bandwidth: 1.4 MHz					
Channel	Frequency (MHz)	99 % Occupied Bandwidth (MHz)		26 dB Bandwidth (MHz)	
		QPSK	16QAM	QPSK	16QAM
26797	824.7	1.0920	1.0832	1.269	1.269
26915	836.5	1.0892	1.0888	1.272	1.271
27033	848.3	1.0874	1.0868	1.271	1.266

Channel Bandwidth: 3 MHz					
Channel	Frequency (MHz)	99 % Occupied Bandwidth (MHz)		26 dB Bandwidth (MHz)	
		QPSK	16QAM	QPSK	16QAM
26805	825.5	1.0847	1.0785	1.261	1.260
26915	836.5	1.0776	1.0806	1.267	1.272
27025	847.5	1.0788	1.0810	1.264	1.276

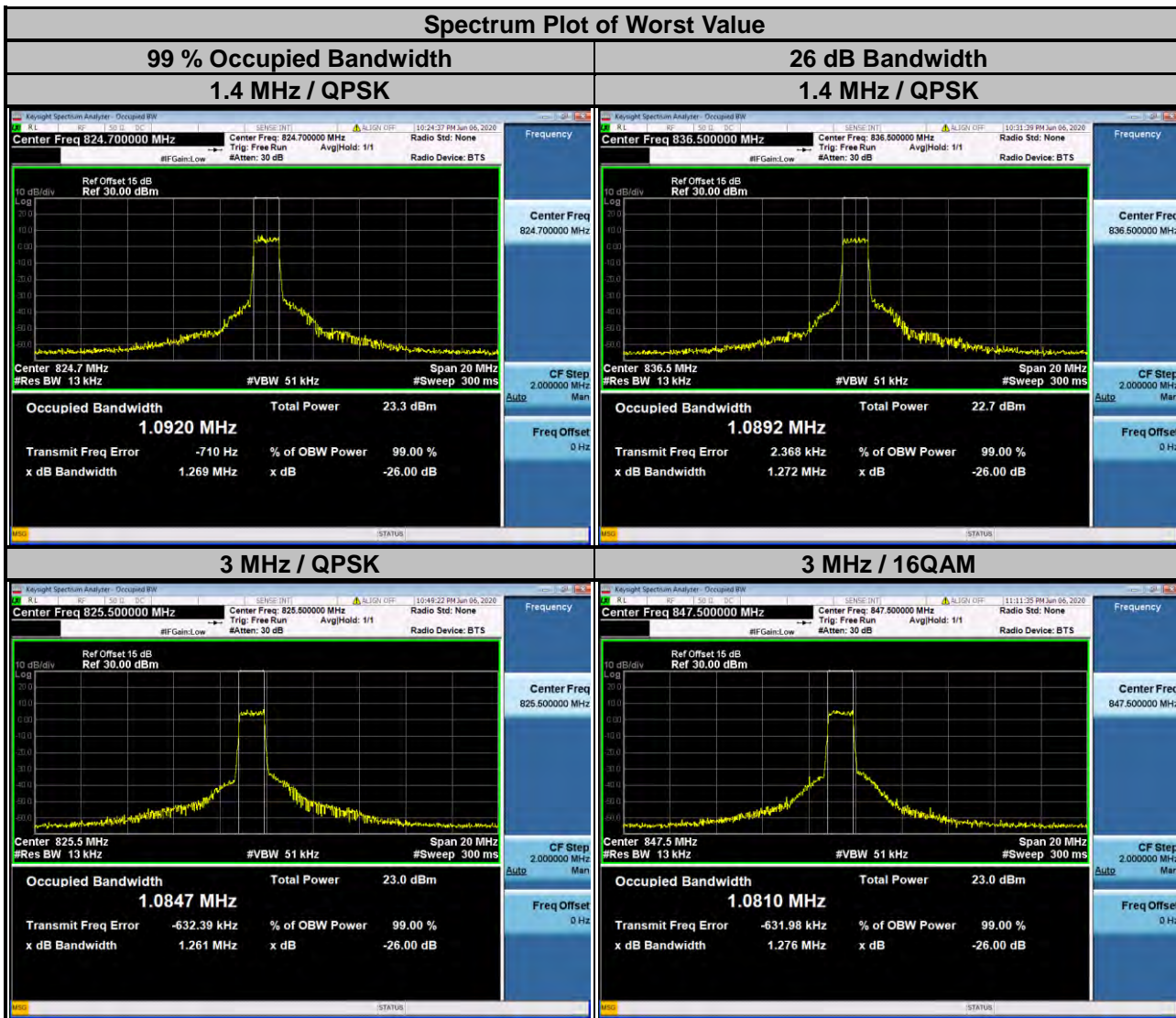

LTE Band 26					
Channel Bandwidth: 5 MHz					
Channel	Frequency (MHz)	99 % Occupied Bandwidth (MHz)		26 dB Bandwidth (MHz)	
		QPSK	16QAM	QPSK	16QAM
26815	826.5	1.0848	1.0750	1.276	1.284
26915	836.5	1.0787	1.0879	1.268	1.294
27015	846.5	1.0829	1.0851	1.171	1.269

Channel Bandwidth: 10 MHz					
Channel	Frequency (MHz)	99 % Occupied Bandwidth (MHz)		26 dB Bandwidth (MHz)	
		QPSK	16QAM	QPSK	16QAM
26840	829.0	1.0920	1.0843	1.266	1.290
26915	836.5	1.0920	1.0825	1.261	1.296
26990	844.0	1.0887	1.0768	1.174	1.269

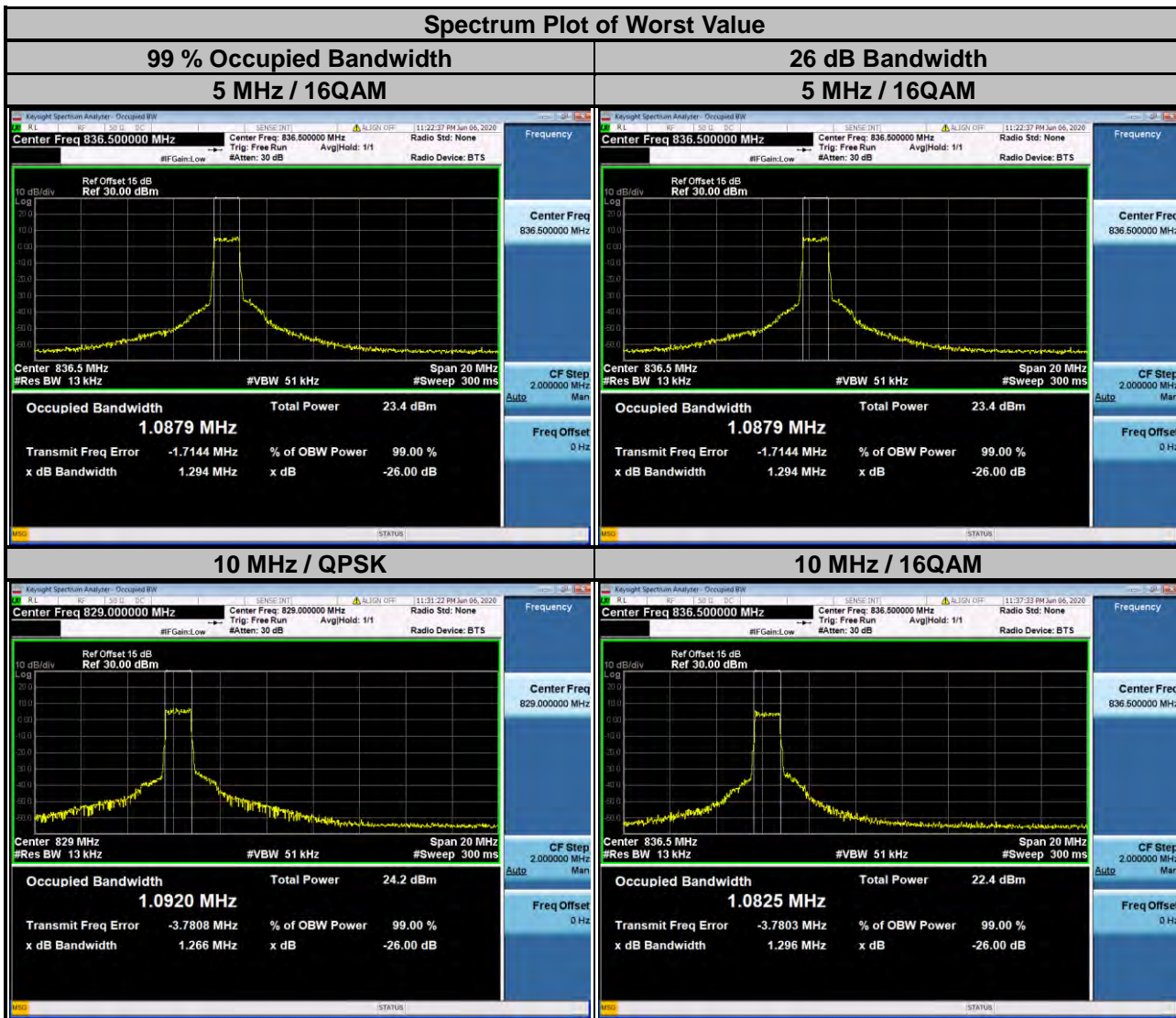

LTE Band 26					
Channel Bandwidth: 15 MHz					
Channel	Frequency (MHz)	99 % Occupied Bandwidth (MHz)		26 dB Bandwidth (MHz)	
		QPSK	16QAM	QPSK	16QAM
26865	831.5	1.0983	1.0901	1.270	1.283
26915	836.5	1.0966	1.0851	1.279	1.286
26965	841.5	1.0788	1.0854	1.266	1.289

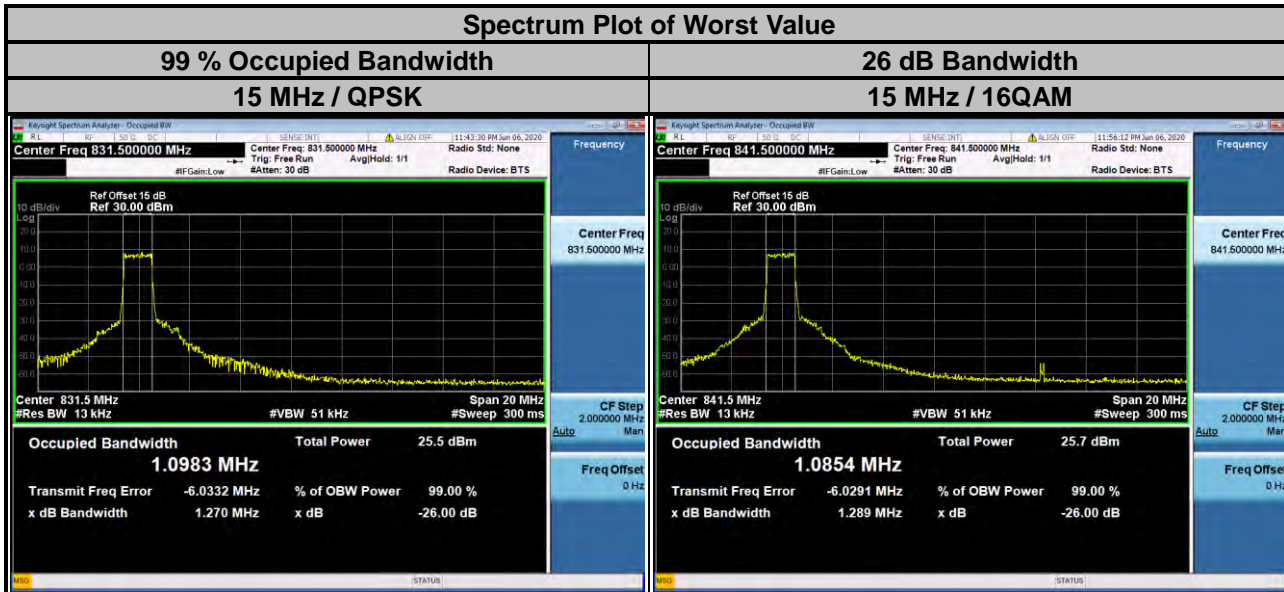

NB-IoT

LTE Band 5						
Channel	Frequency (MHz)	Modulation	N _{tones}	Sub-carrier Spacing (kHz)	99 % Occupied Bandwidth (kHz)	26 dB Bandwidth (kHz)
24042	824.2	BPSK	1@0	3.75	37.60	28.31
		BPSK	1@0	15	95.738	111.5
		QPSK	1@0	3.75	37.802	29.73
		QPSK	1@0	15	97.984	113.2
		QPSK	12@0	15	185.26	262.50
20525	836.5	BPSK	1@0	3.75	58.64	38.86
		BPSK	1@0	15	101.36	137.8
		QPSK	1@0	3.75	54.194	41.08
		QPSK	1@0	15	98.855	112.8
		QPSK	12@0	15	189.63	265.00
20648	848.8	BPSK	1@47	3.75	47.17	27.57
		BPSK	1@11	15	98.270	101.2
		QPSK	1@47	3.75	55.748	41.46
		QPSK	1@11	15	99.496	138.2
		QPSK	12@0	15	191.55	272.60

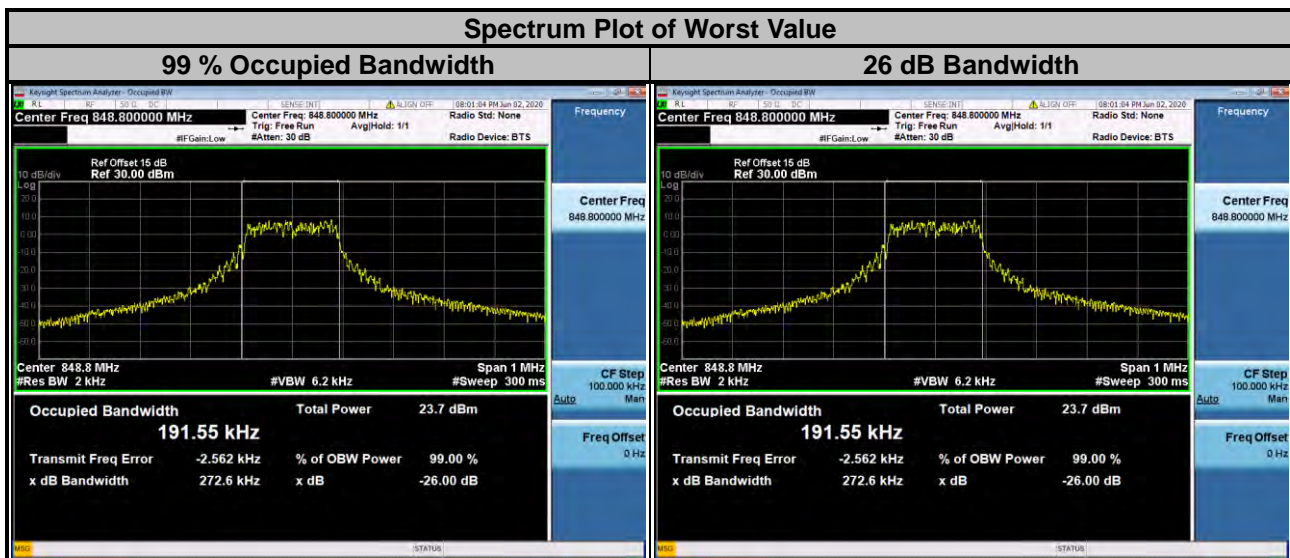

LTE Band 26						
Channel	Frequency (MHz)	Modulation	N _{tones}	Sub-carrier Spacing (kHz)	99 % Occupied Bandwidth (kHz)	26 dB Bandwidth (kHz)
26792	824.2	BPSK	1@0	3.75	56.35	38.91
		BPSK	1@0	15	99.016	109.9
		QPSK	1@0	3.75	54.864	40.91
		QPSK	1@0	15	97.127	123.4
		QPSK	12@0	15	191.74	273.40
26915	836.5	BPSK	1@0	3.75	56.95	38.50
		BPSK	1@0	15	101.93	138.0
		QPSK	1@0	3.75	54.035	38.08
		QPSK	1@0	15	97.447	113.8
		QPSK	12@0	15	190.41	267.10
27038	848.8	BPSK	1@47	3.75	40.13	27.15
		BPSK	1@0	15	99.455	126.9
		QPSK	1@0	3.75	53.380	40.96
		QPSK	1@0	15	98.986	114.9
		QPSK	12@0	15	189.50	260.20

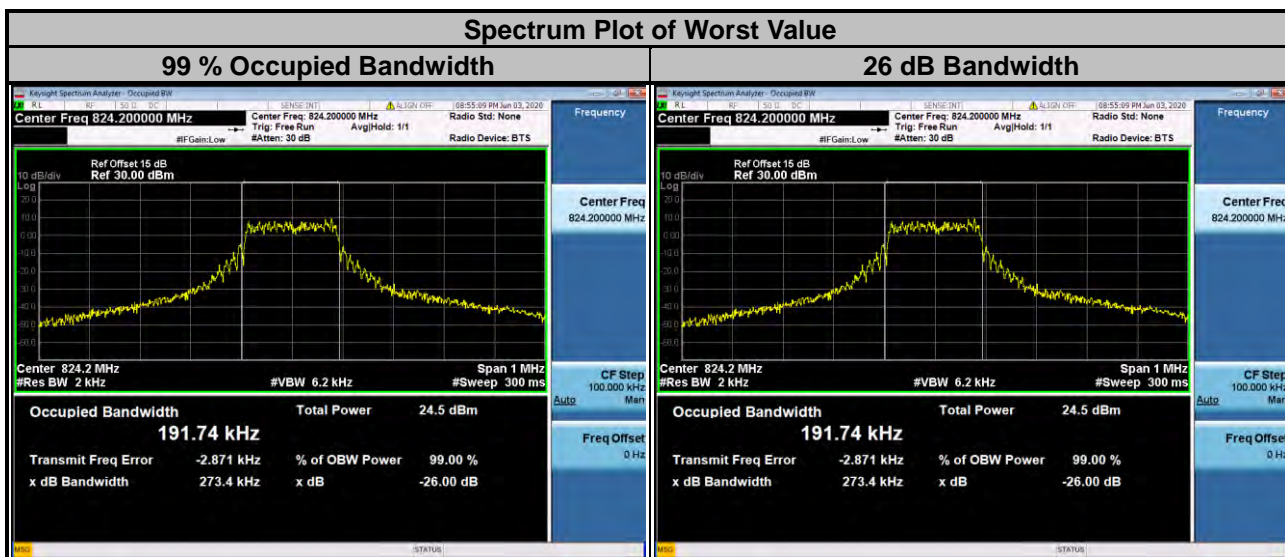

4.5 Band Edge Measurement

4.5.1 Limits of Band Edge Measurement

Power of any emission outside of the authorized operating frequency ranges must be attenuated below the transmitting power (P) by a factor of at least $43 + 10 \log(P)$ dB. In the 1 MHz bands immediately outside and adjacent to the frequency block a resolution bandwidth of at least one percent of the emission bandwidth of the fundamental emission of the transmitter may be employed.

4.5.2 Test Setup

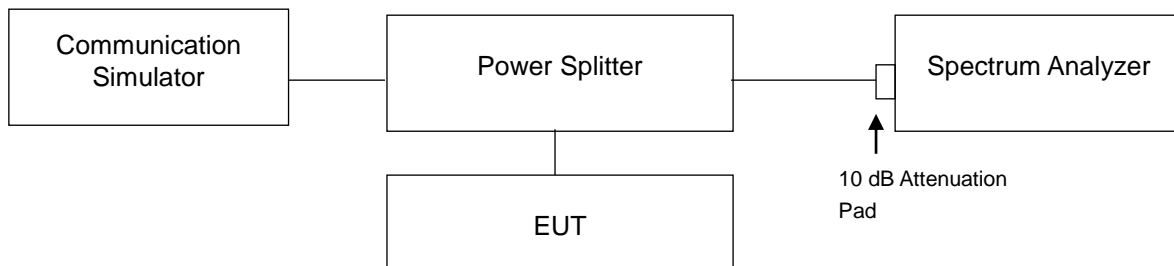

4.5.3 Test Procedures

- All measurements were done at low and high operational frequency range.
- The center frequency of spectrum is the band edge frequency and span is 5 MHz. RB of the spectrum is 30 kHz and VB of the spectrum is 91 kHz for Cat-M1.
- The center frequency of spectrum is the band edge frequency and span is 1 MHz. RB of the spectrum is 4.3 kHz and VB of the spectrum is 12 kHz for NB-IoT.
- Record the max trace plot into the test report.

4.5.4 Test Results

Cat-M1

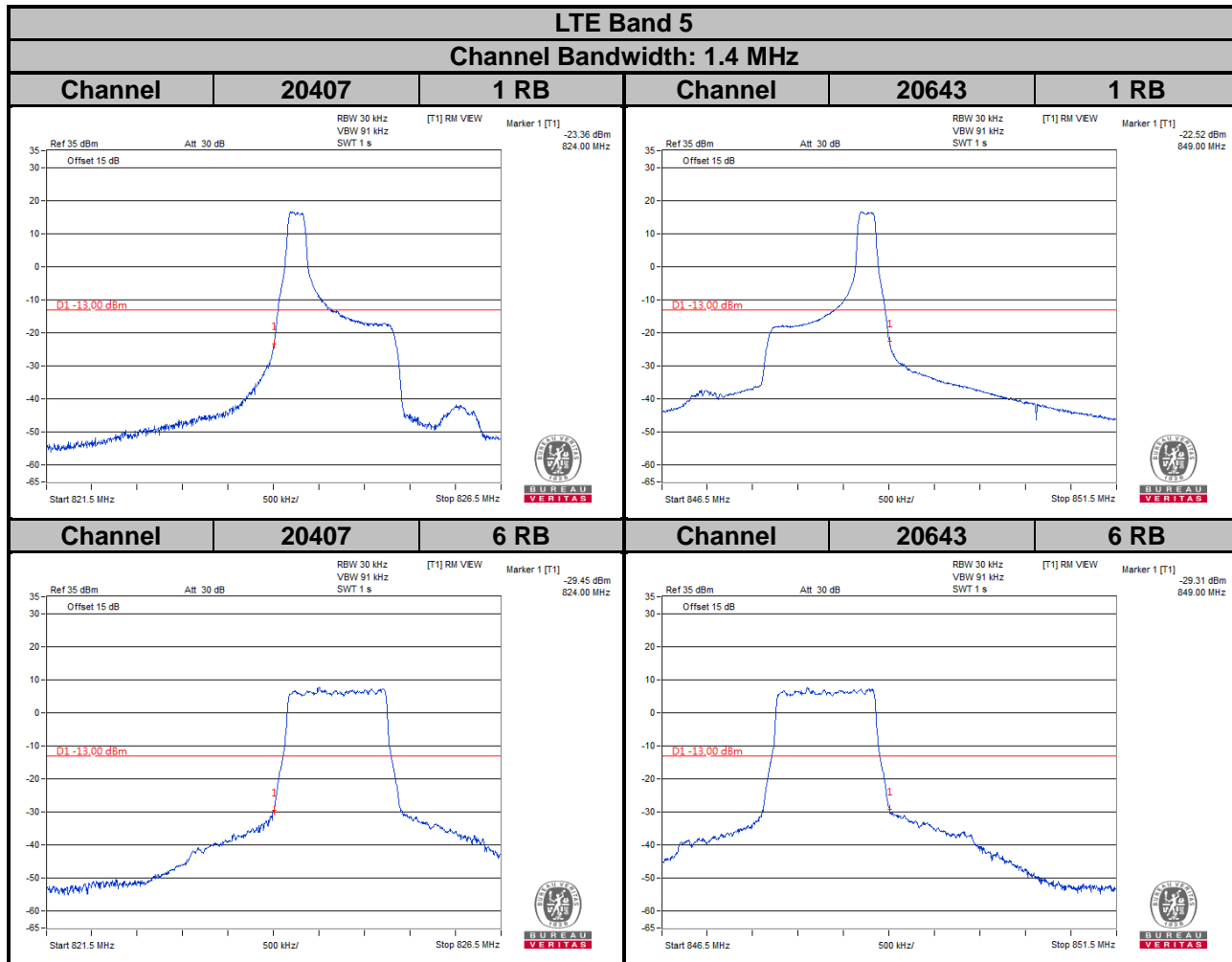

LTE Band 5

Channel Bandwidth: 3 MHz

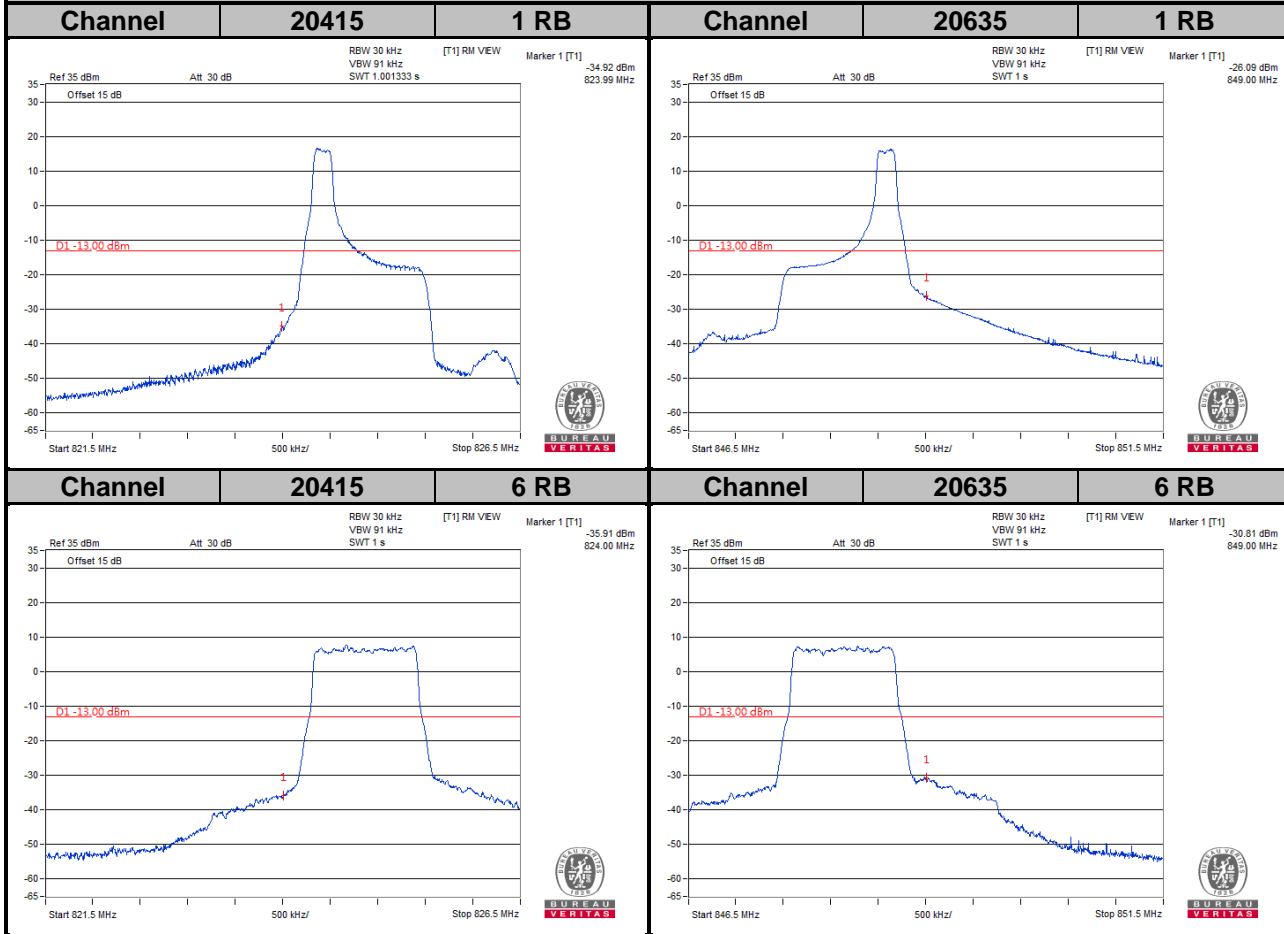

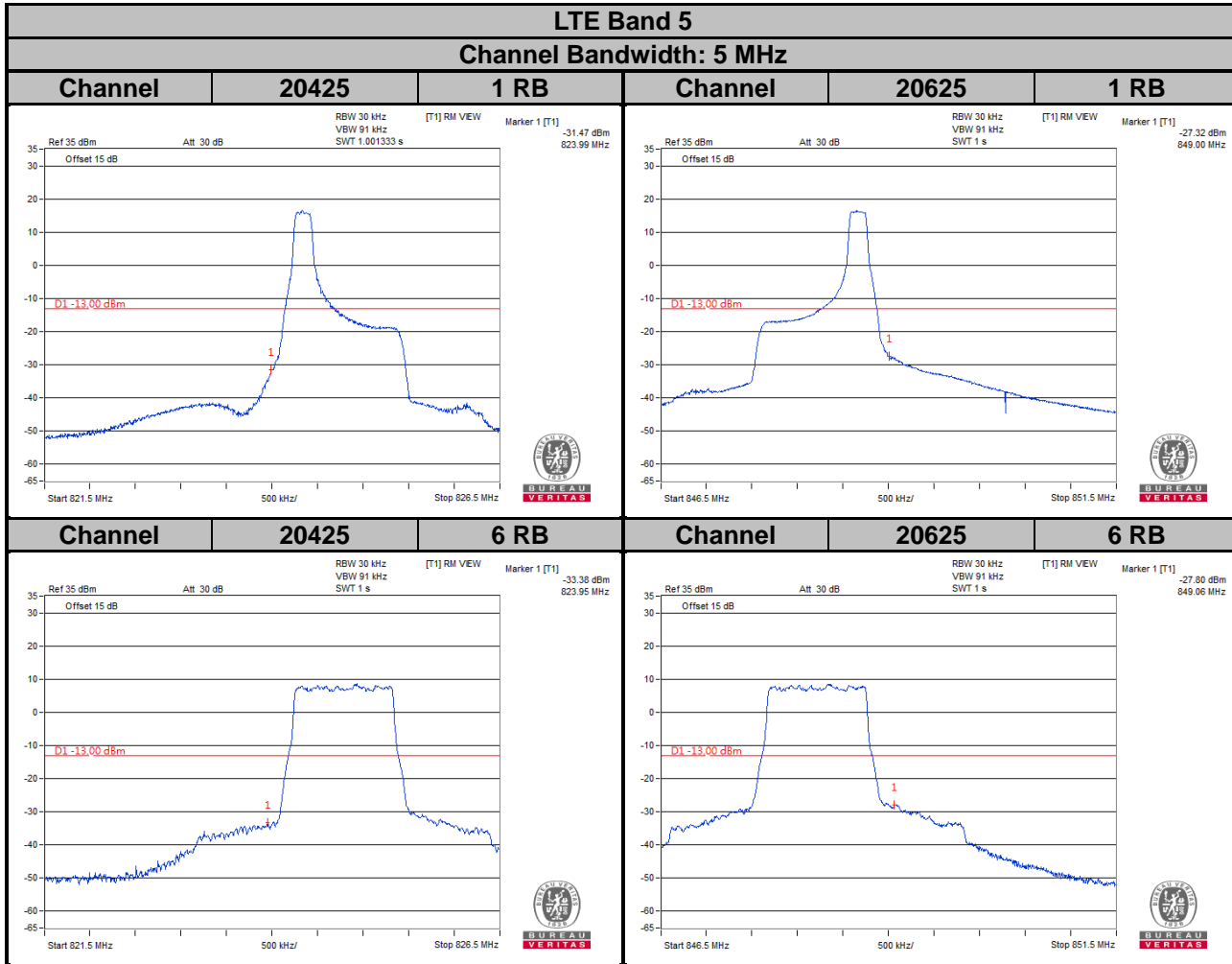

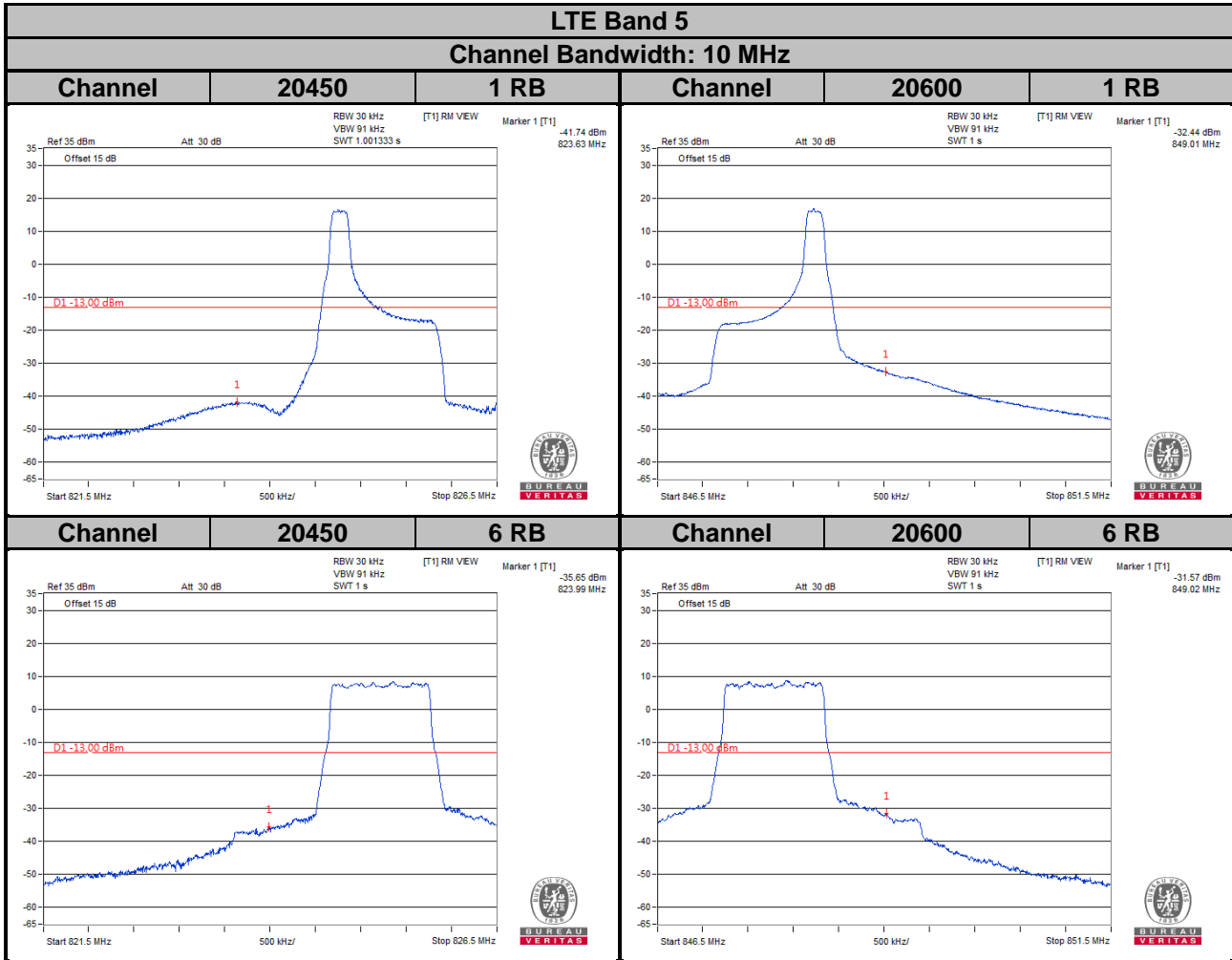

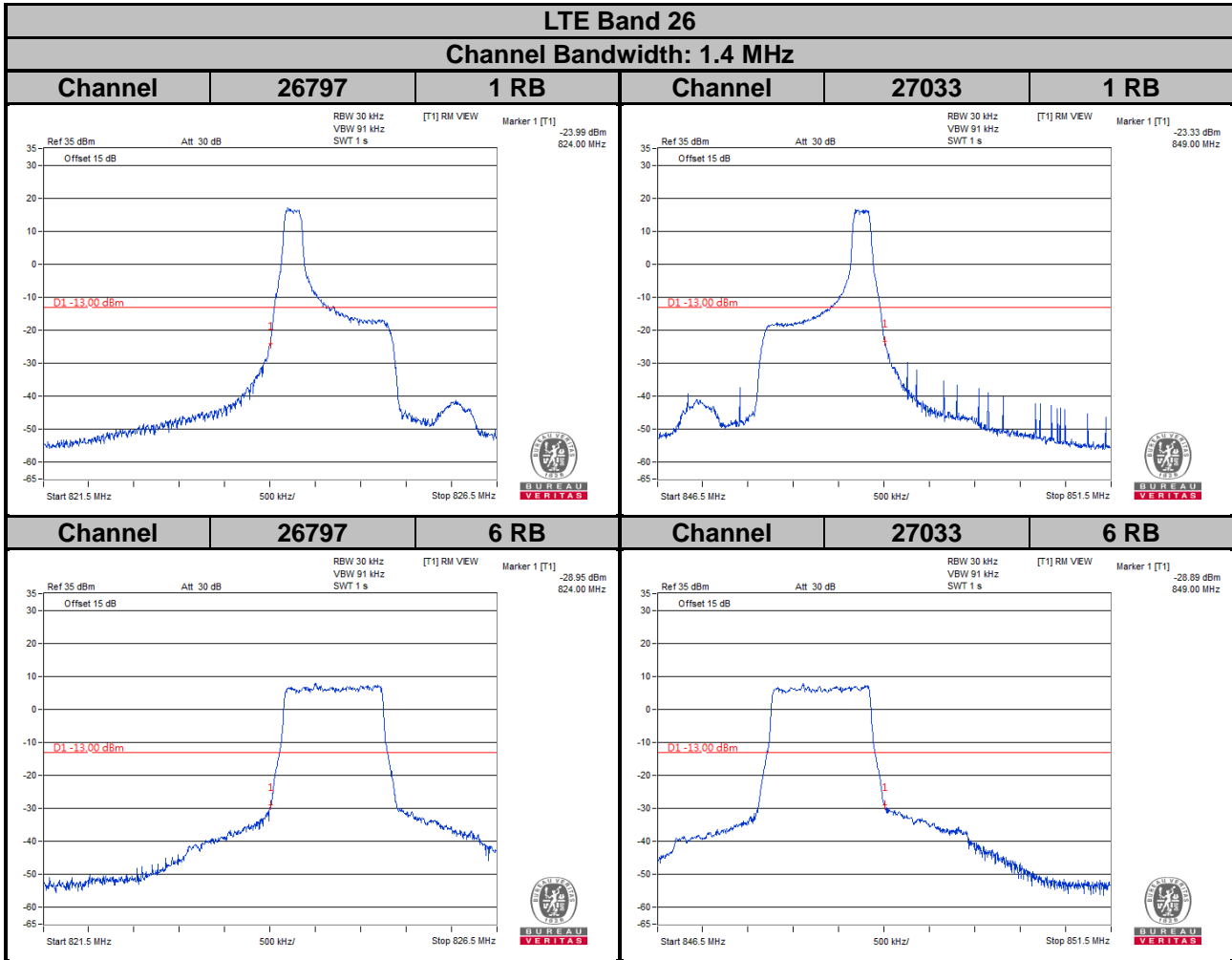

LTE Band 26
Channel Bandwidth: 3 MHz

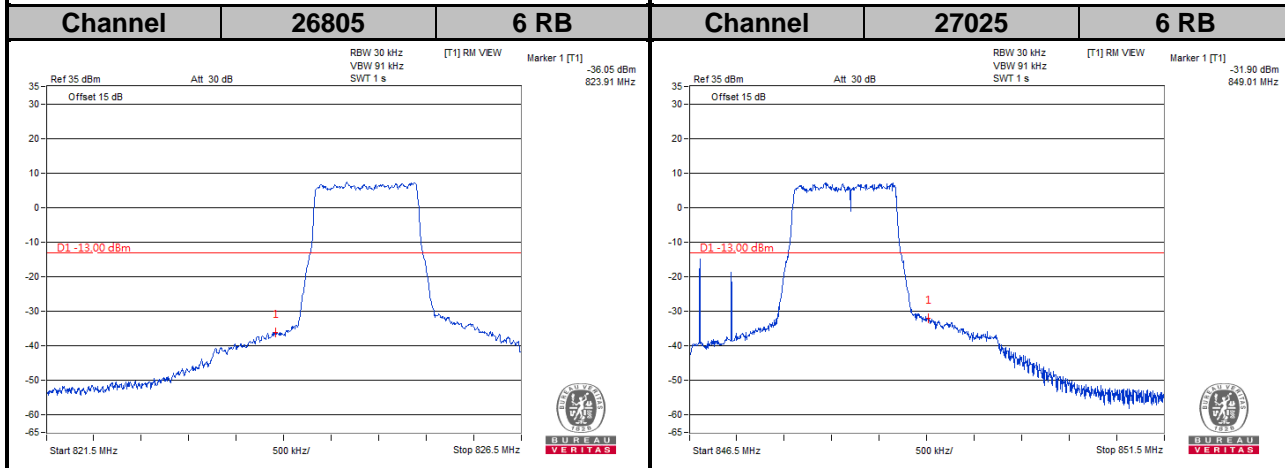
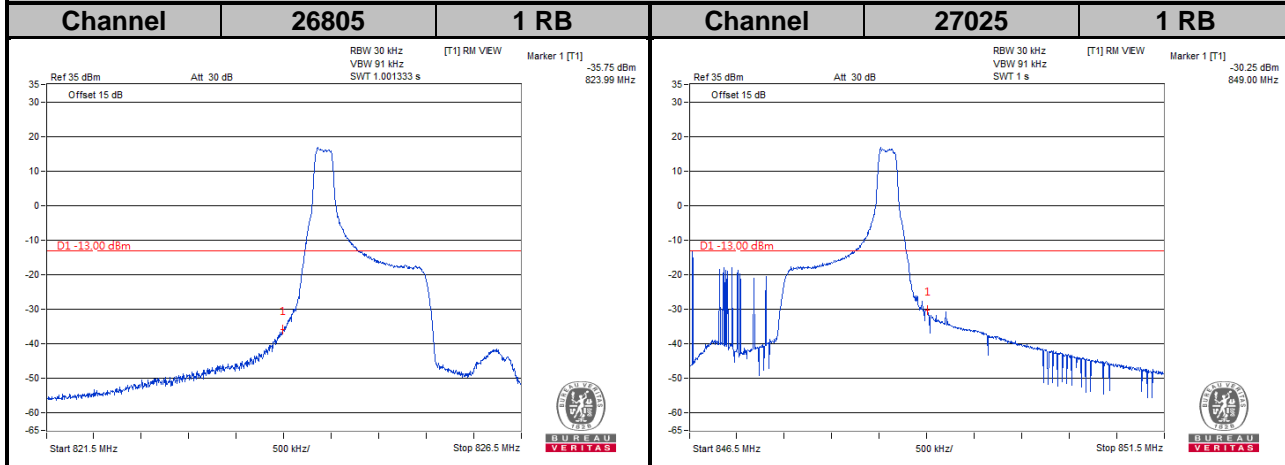

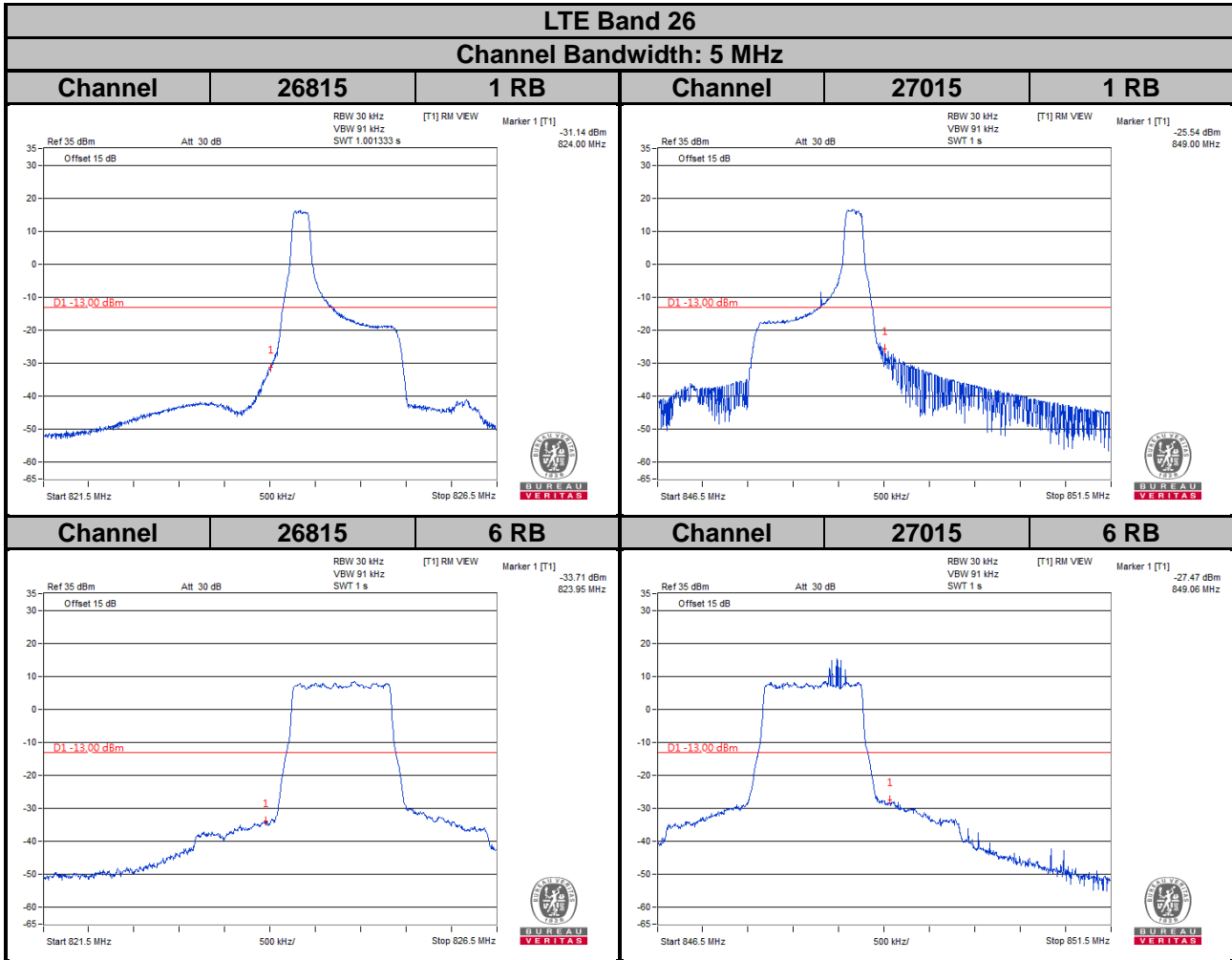

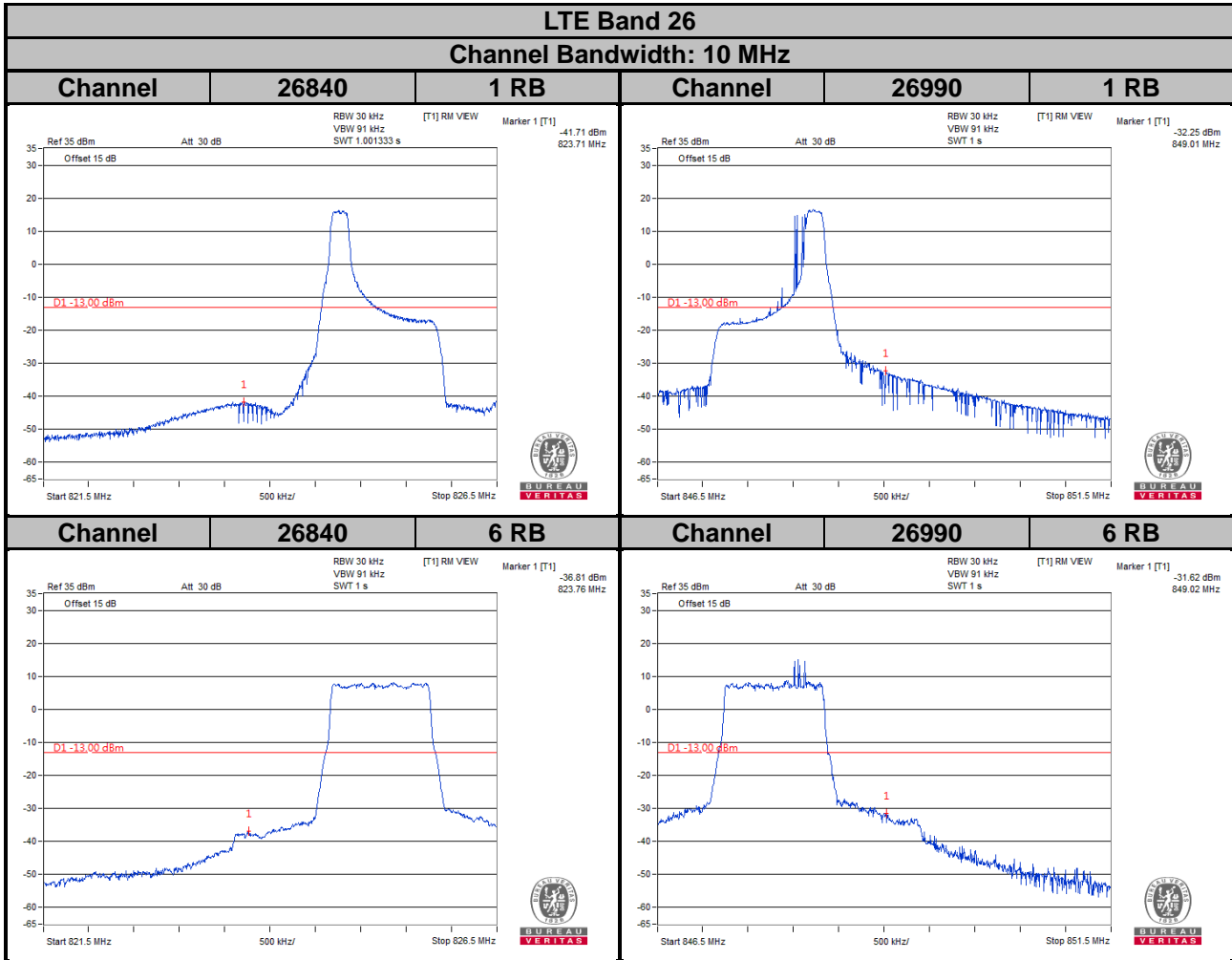

LTE Band 26
Channel Bandwidth: 15 MHz

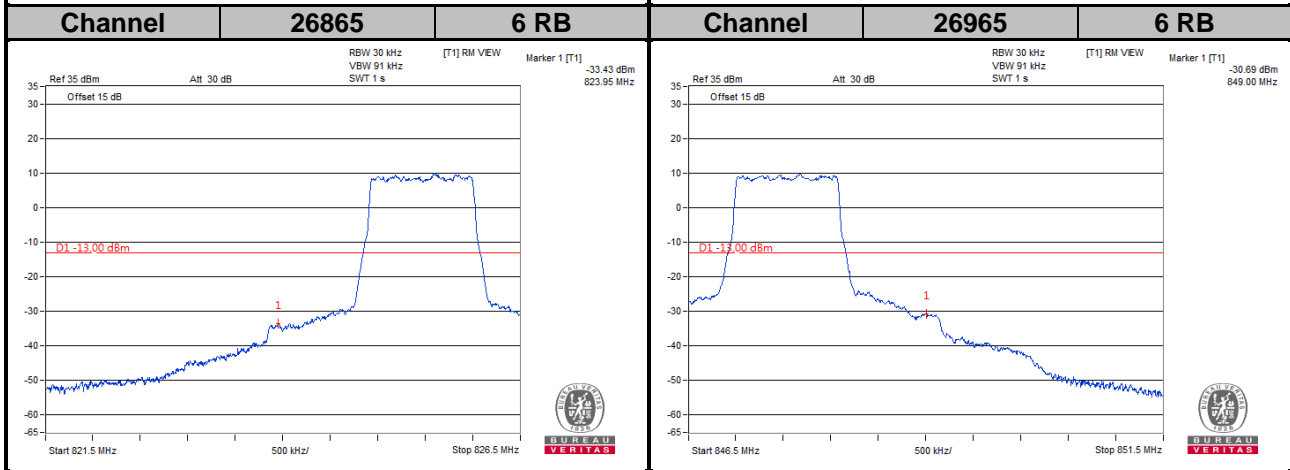
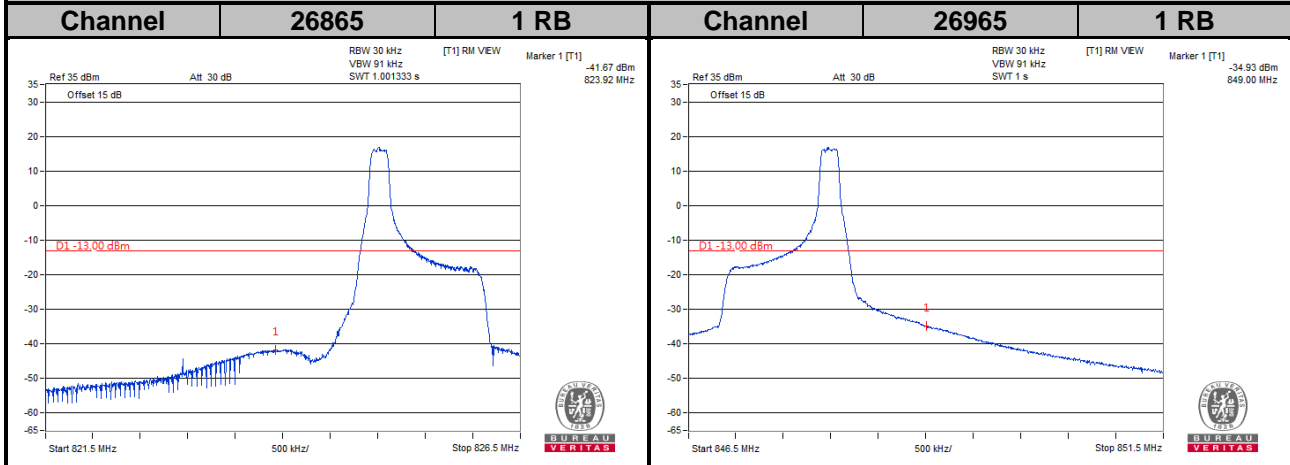

NB-IoT

**LTE Band 5
BPSK**

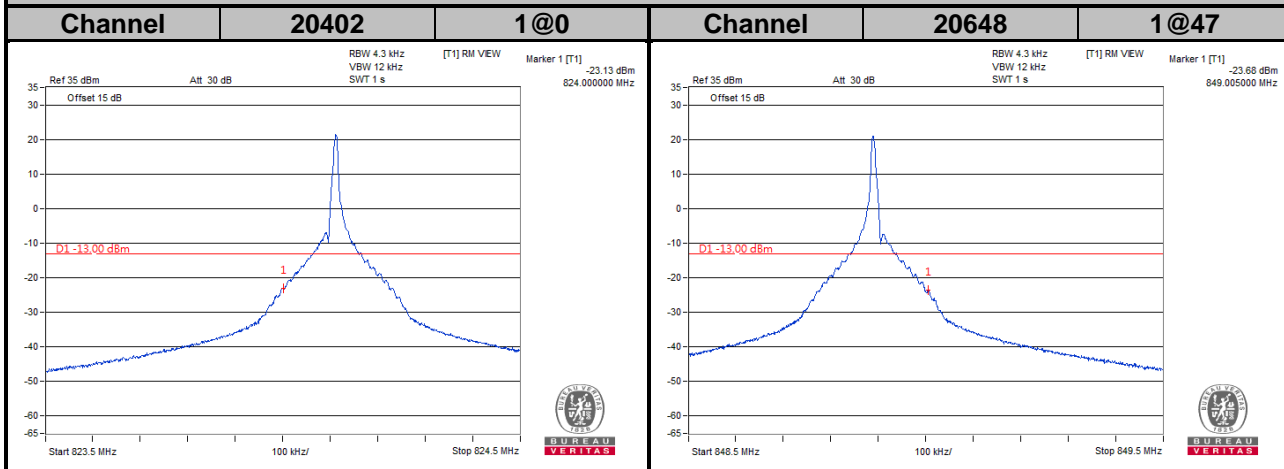

QPSK

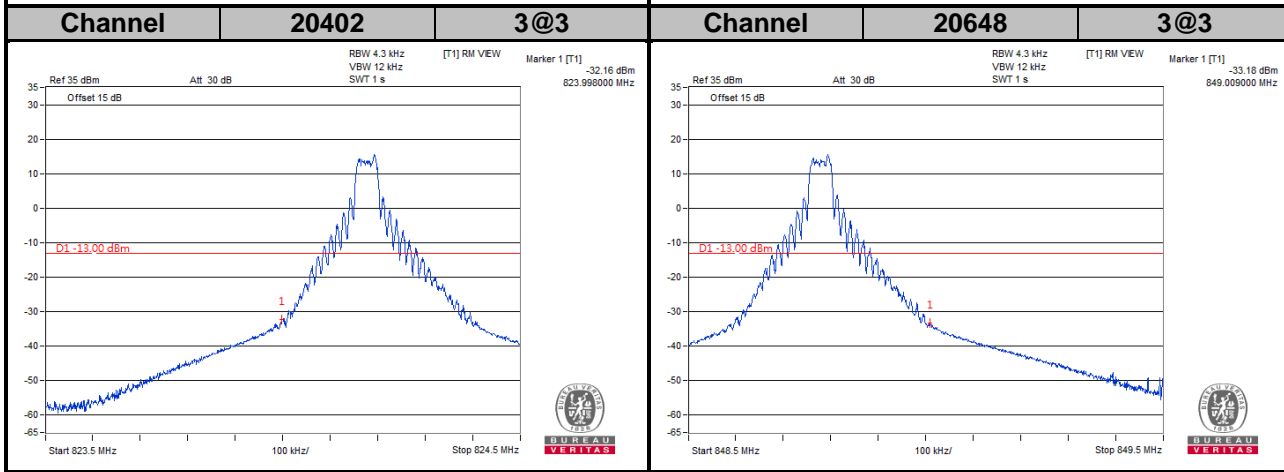
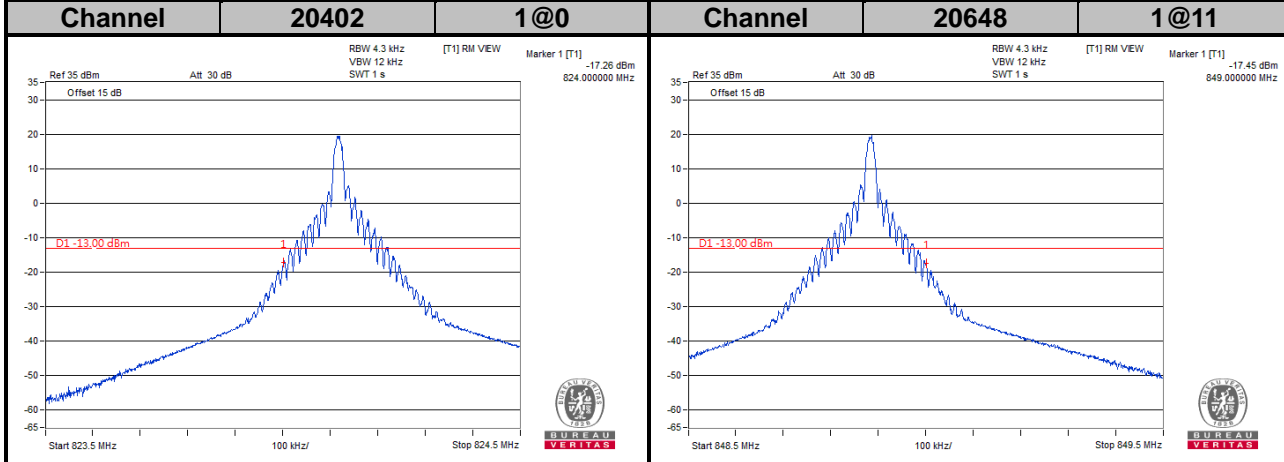

LTE Band 5

QPSK

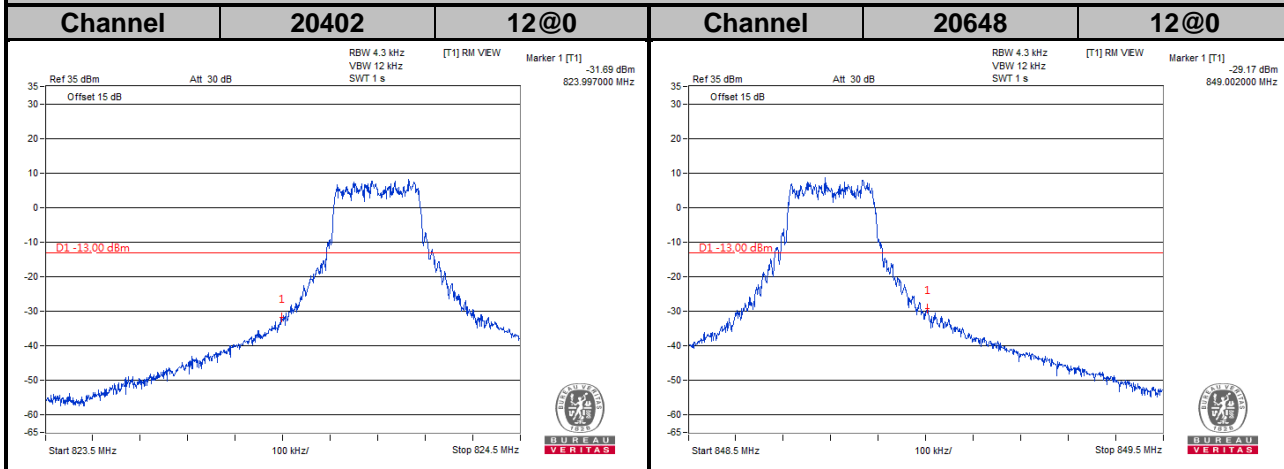

LTE Band 26

BPSK

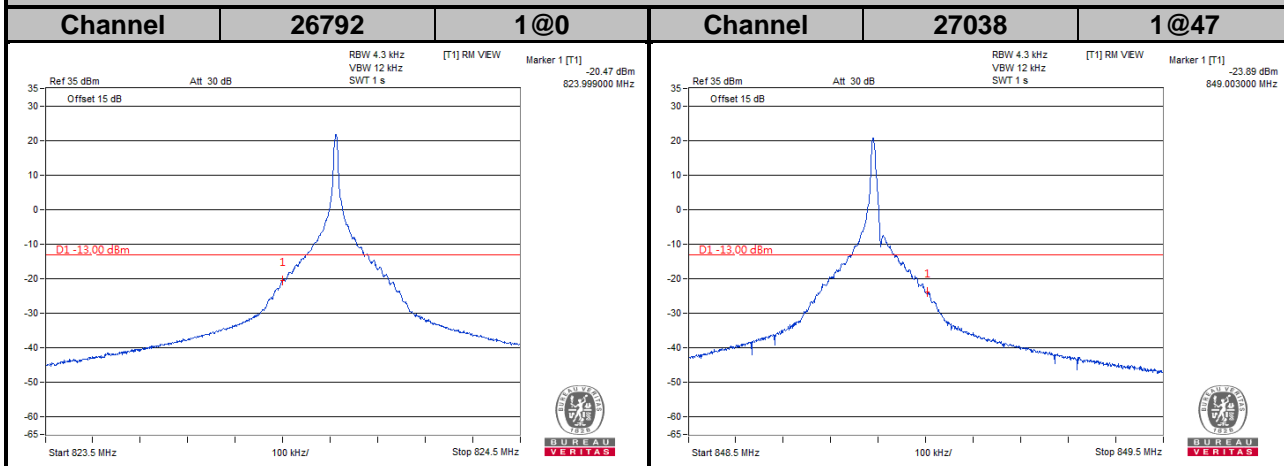

QPSK

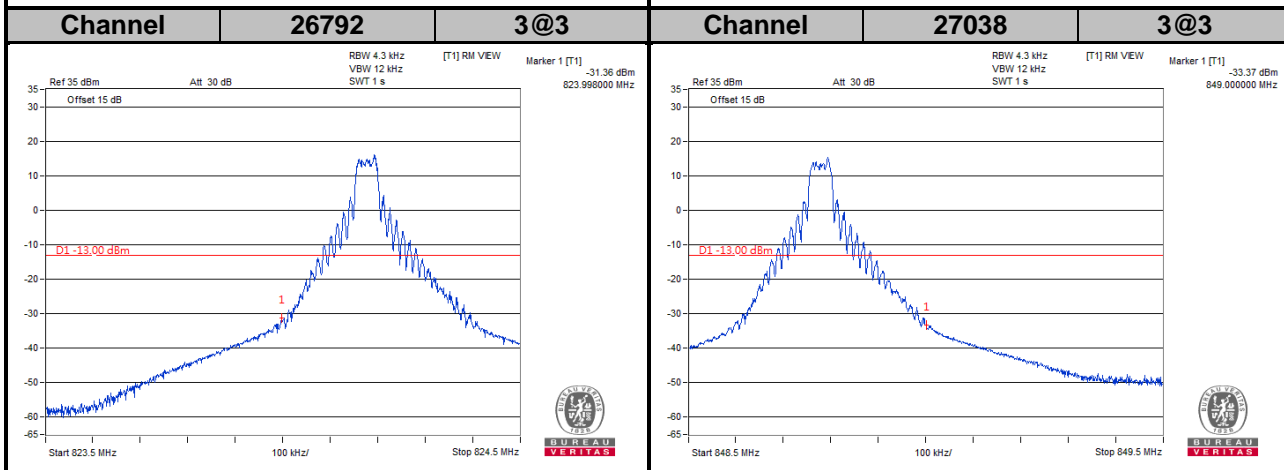
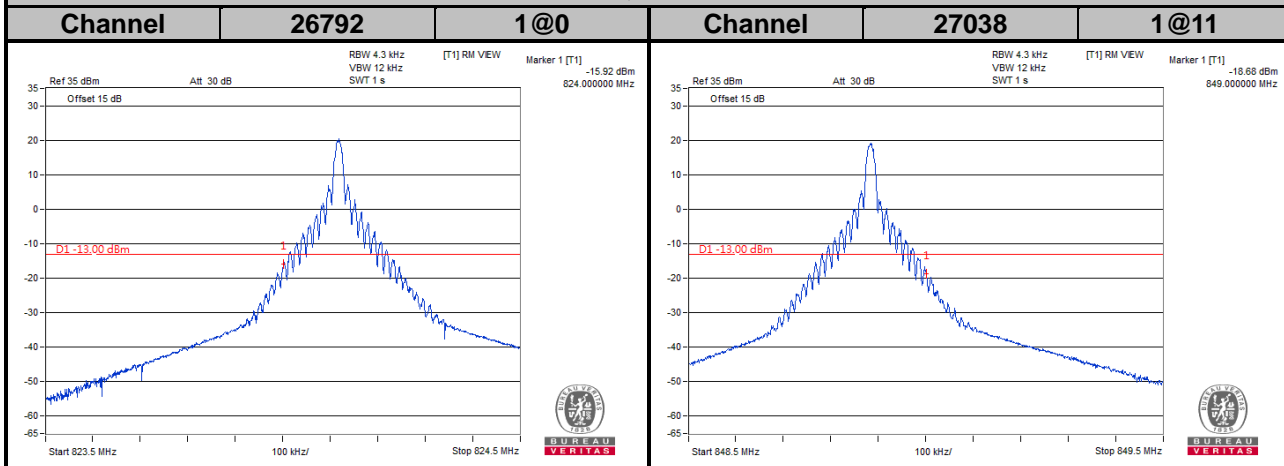

LTE Band 26

QPSK

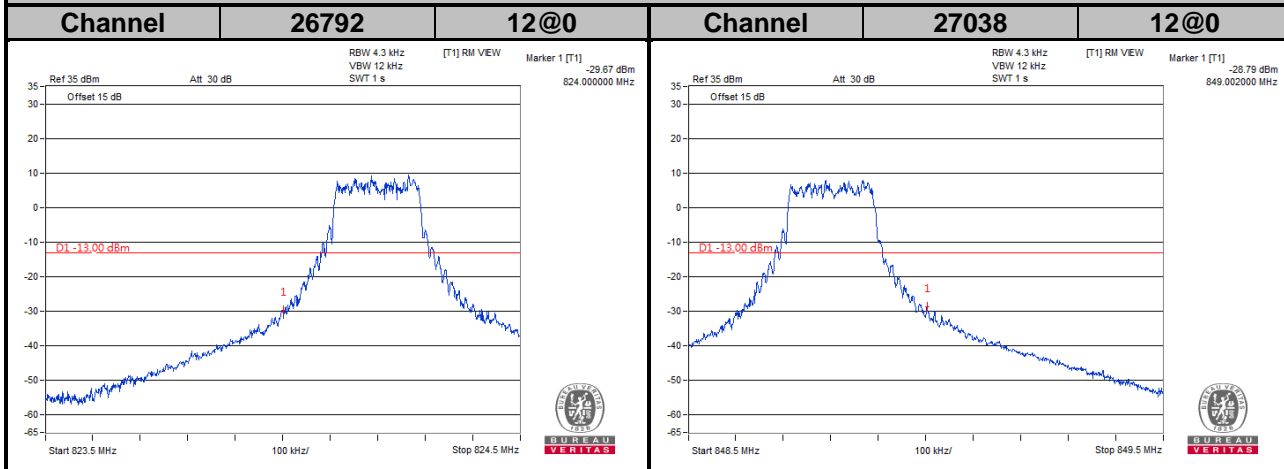

4.6 Peak to Average Ratio

4.6.1 Limits of Peak to Average Ratio Measurement

In measuring transmissions in this band using an average power technique, the peak to-average ratio (PAR) of the transmission may not exceed 13 dB.

4.6.2 Test Setup

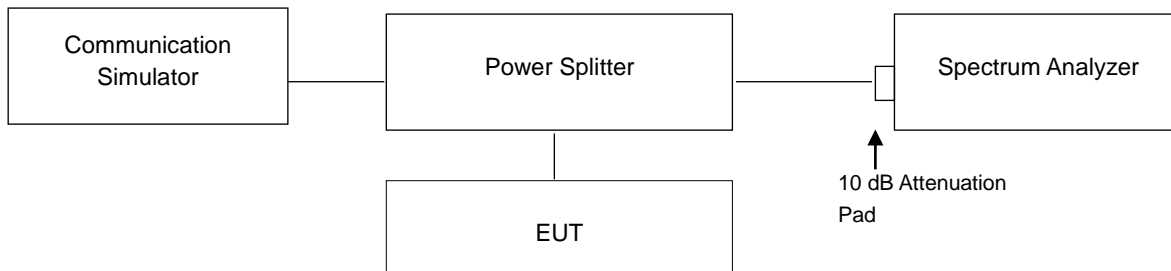

4.6.3 Test Procedures

1. Set resolution/measurement bandwidth \geq signal's occupied bandwidth;
2. Set the number of counts to a value that stabilizes the measured CCDF curve;
3. Record the maximum PAPR level associated with a probability of 0.1 %.

4.6.4 Test Results

Cat-M1

LTE Band 5							
Channel Bandwidth: 1.4 MHz				Channel Bandwidth: 3 MHz			
Channel	Frequency (MHz)	Peak to Average Ratio (dB)		Channel	Frequency (MHz)	Peak to Average Ratio (dB)	
		QPSK	16QAM			QPSK	16QAM
20407	824.7	5.45	6.79	20415	825.5	5.38	6.71
20525	836.5	5.56	6.77	20525	836.5	5.63	6.83
20643	848.3	5.61	6.94	20635	847.5	6.45	6.92

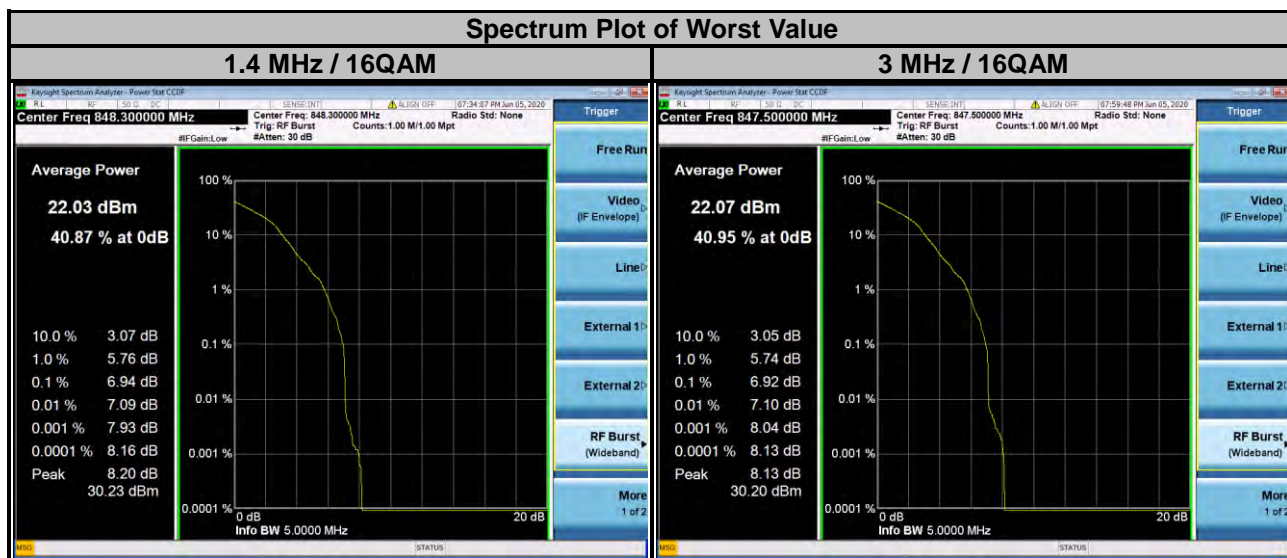

LTE Band 5							
Channel Bandwidth: 5 MHz				Channel Bandwidth: 10 MHz			
Channel	Frequency (MHz)	Peak to Average Ratio (dB)		Channel	Frequency (MHz)	Peak to Average Ratio (dB)	
		QPSK	16QAM			QPSK	16QAM
20425	826.5	6.21	6.63	20450	829.0	6.58	6.65
20525	836.5	6.26	6.63	20525	836.5	6.35	6.66
20625	846.5	6.45	6.77	20600	844.0	6.27	6.70

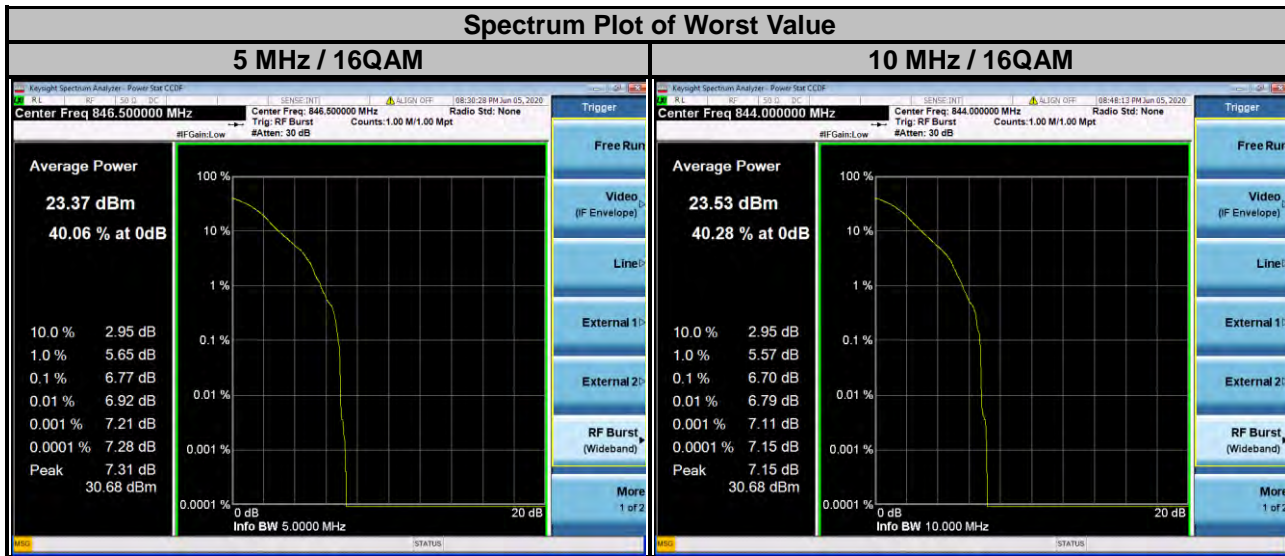

LTE Band 26

Channel Bandwidth: 1.4 MHz				Channel Bandwidth: 3 MHz			
Channel	Frequency (MHz)	Peak to Average Ratio (dB)		Channel	Frequency (MHz)	Peak to Average Ratio (dB)	
		QPSK	16QAM			QPSK	16QAM
26797	824.7	5.36	6.63	26805	825.5	5.40	6.69
26915	836.5	5.52	6.83	26915	836.5	5.43	6.77
27033	848.3	5.64	6.89	27025	847.5	5.58	6.90

Spectrum Plot of Worst Value

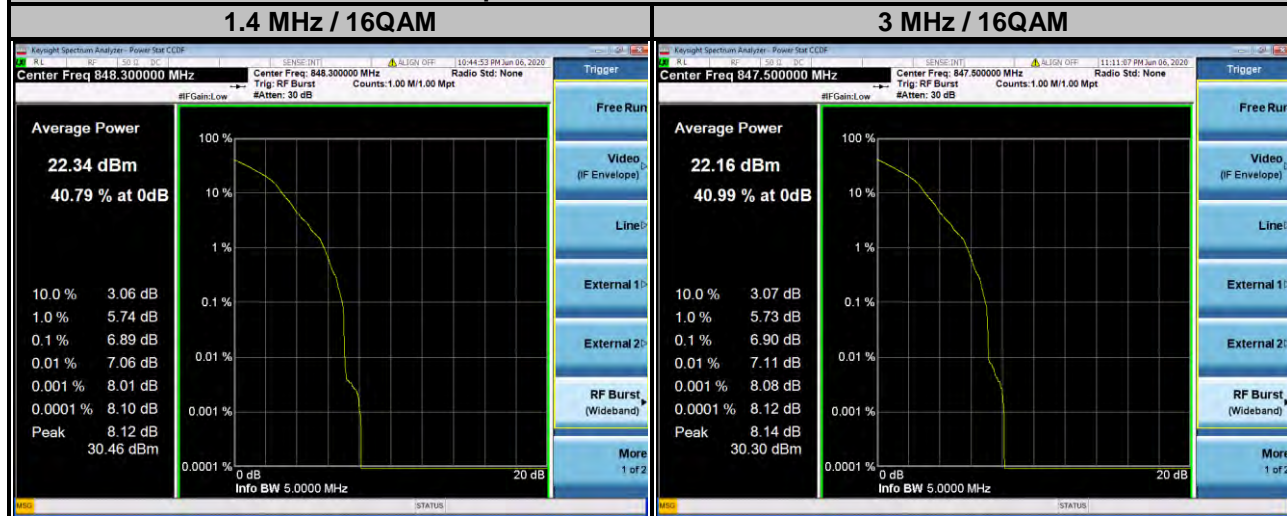

LTE Band 26

Channel Bandwidth: 5 MHz				Channel Bandwidth: 10 MHz			
Channel	Frequency (MHz)	Peak to Average Ratio (dB)		Channel	Frequency (MHz)	Peak to Average Ratio (dB)	
		QPSK	16QAM			QPSK	16QAM
26815	826.5	6.21	7.23	26840	829.0	6.20	6.55
26915	836.5	6.23	6.57	26915	836.5	6.24	6.54
27015	846.5	6.33	6.73	26990	844.0	6.62	6.78

Spectrum Plot of Worst Value

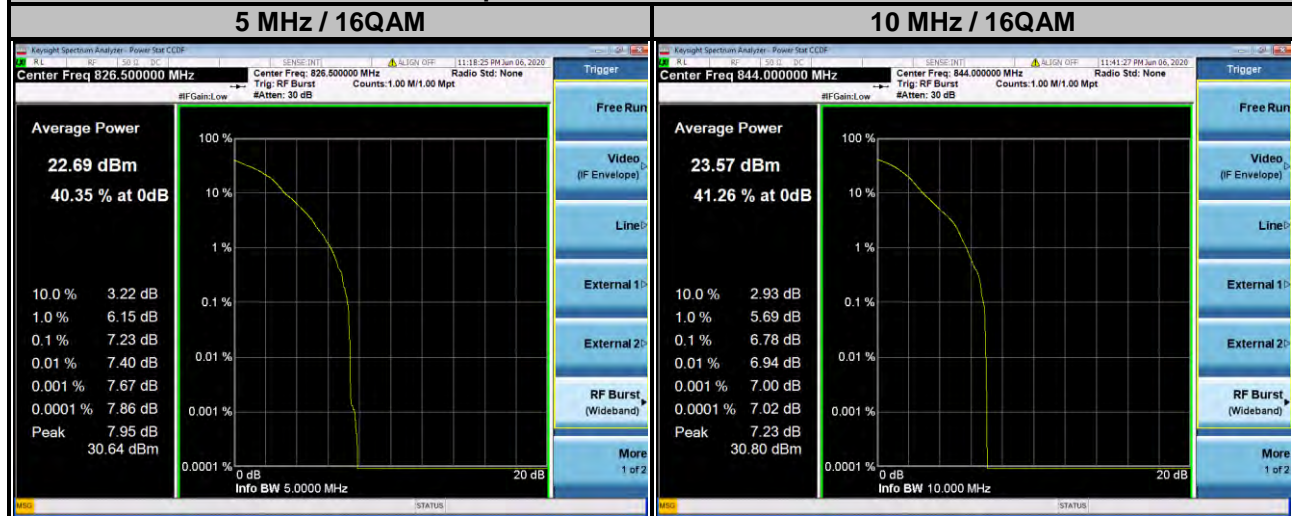

LTE Band 26			
Channel Bandwidth: 15 MHz			
Channel	Frequency (MHz)	Peak to Average Ratio (dB)	
		QPSK	16QAM
26865	831.5	6.17	6.52
26915	836.5	6.21	6.82
26965	841.5	6.23	6.64

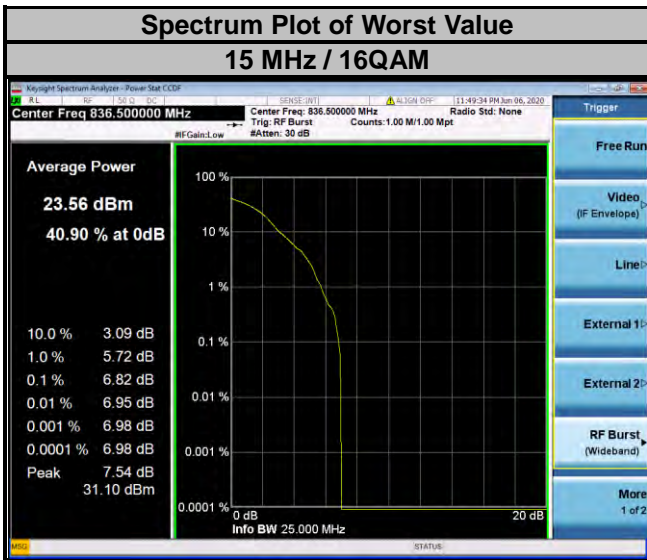

NB-IoT

LTE Band 5					
Channel	Frequency (MHz)	Modulation	N _{tones}	Sub-carrier Spacing (kHz)	PAPR (dB)
20525	836.5	BPSK	1@0	3.75	1.76
20525	836.5	QPSK	1@0	15	5.14
20525	836.5	QPSK	3@3	15	6.97

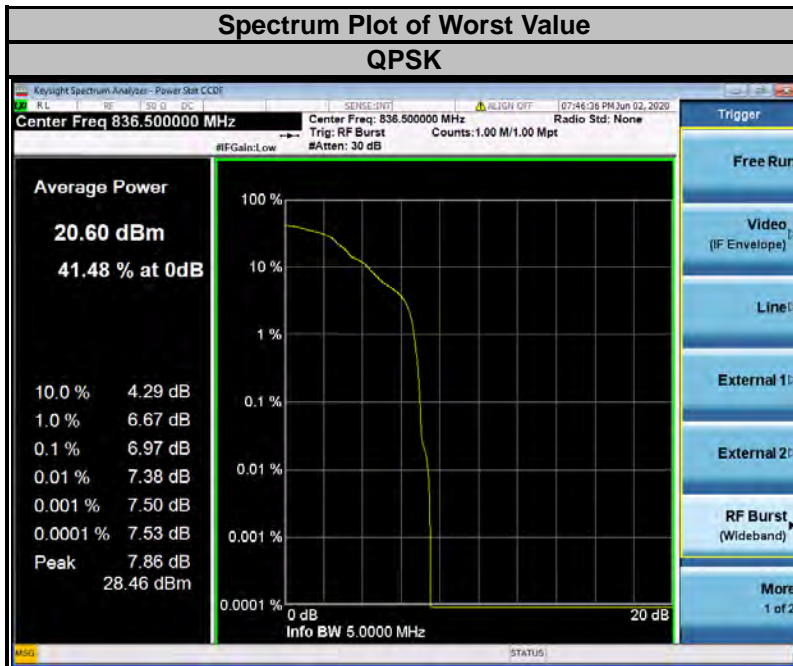

LTE Band 26					
Channel	Frequency (MHz)	Modulation	N _{tones}	Sub-carrier Spacing (kHz)	PAPR (dB)
26915	836.5	BPSK	1@0	3.75	1.84
26915	836.5	QPSK	1@0	15	5.12
26915	836.5	QPSK	3@3	15	6.95

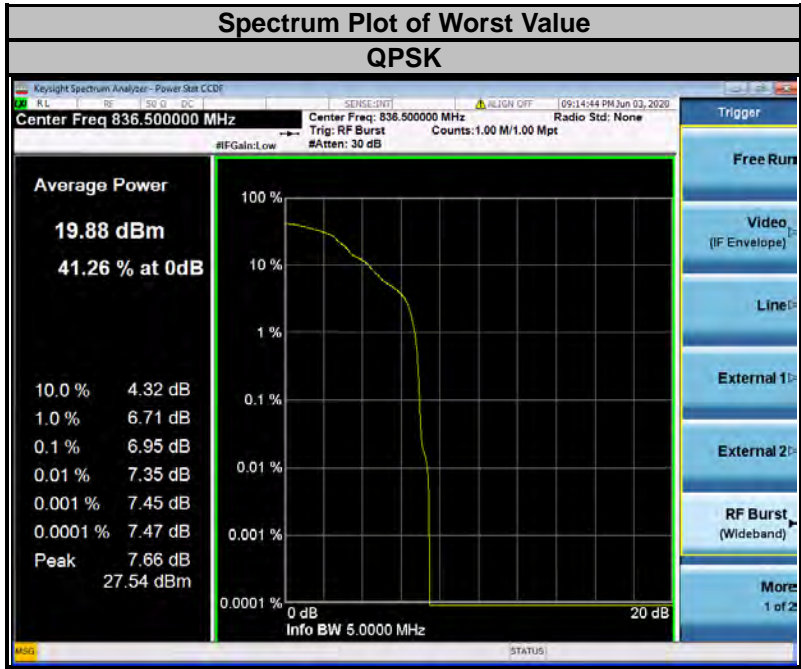

4.7 Conducted Spurious Emissions

4.7.1 Limits of Conducted Spurious Emissions Measurement

The power of any emission outside of the authorized operating frequency ranges must be attenuated below the transmitting power (P) by a factor of at least $43 + 10 \log(P)$ dB. The emission limit equal to -13 dBm.

4.7.2 Test Setup

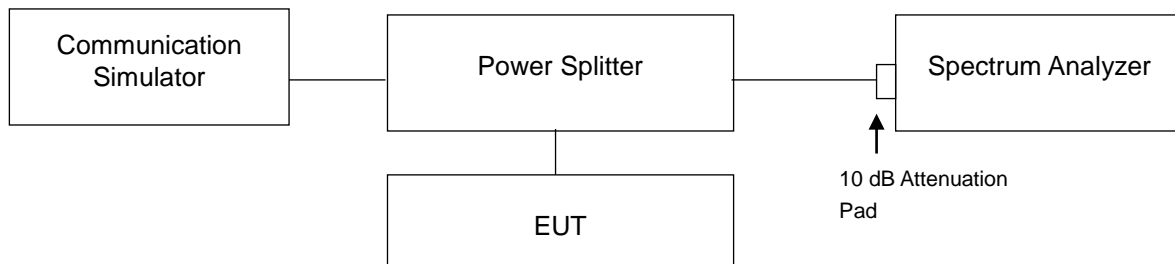

4.7.3 Test Procedure

- The EUT makes a phone call to the communication simulator. All measurements were done at low, middle and high operational frequency range.
- Measuring frequency range is from 9 kHz to 1 GHz. 10 dB attenuation pad is connected with spectrum. RBW = 100 kHz and VBW = 300 kHz is used for conducted emission measurement.
- Measuring frequency range is from 1 GHz to 9 GHz. 10 dB attenuation pad is connected with spectrum. RBW = 1 MHz and VBW = 3 MHz is used for conducted emission measurement.

4.7.4 Test Results

Cat-M1

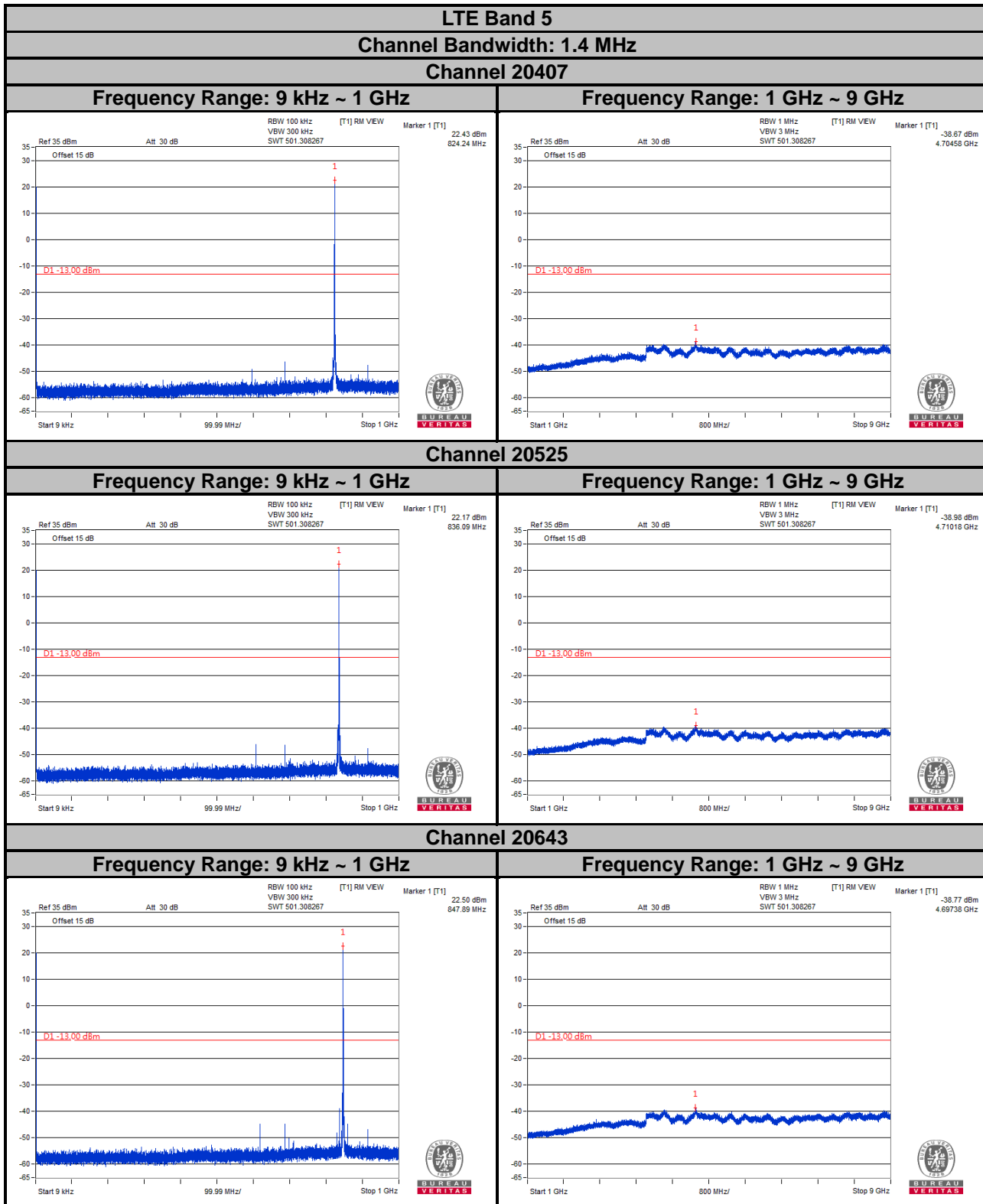

Note: The signal over the limit in 9 kHz is from spectrum analyzer.

LTE Band 5
Channel Bandwidth: 3 MHz

Channel 20415

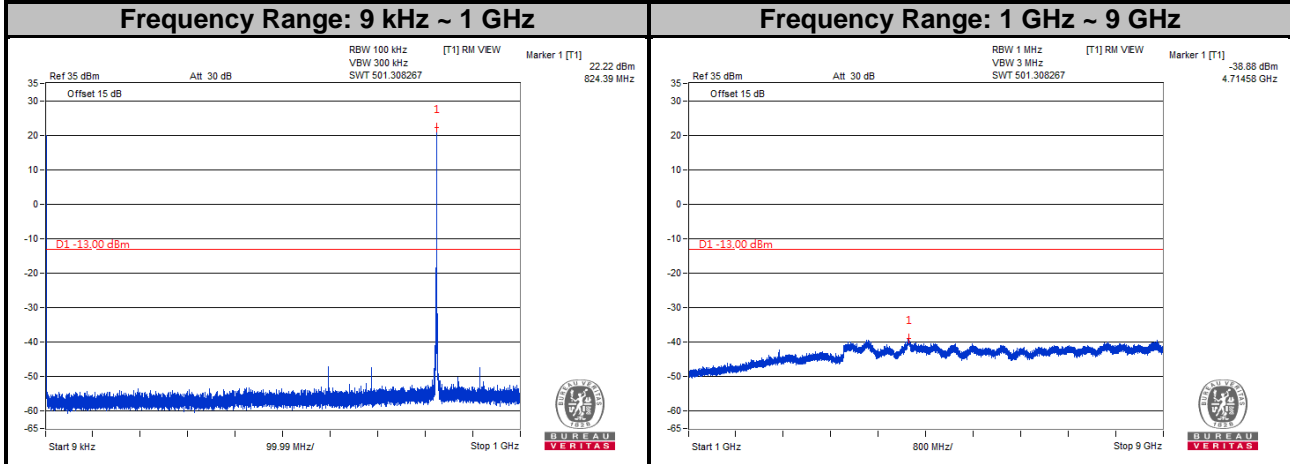

Channel 20525

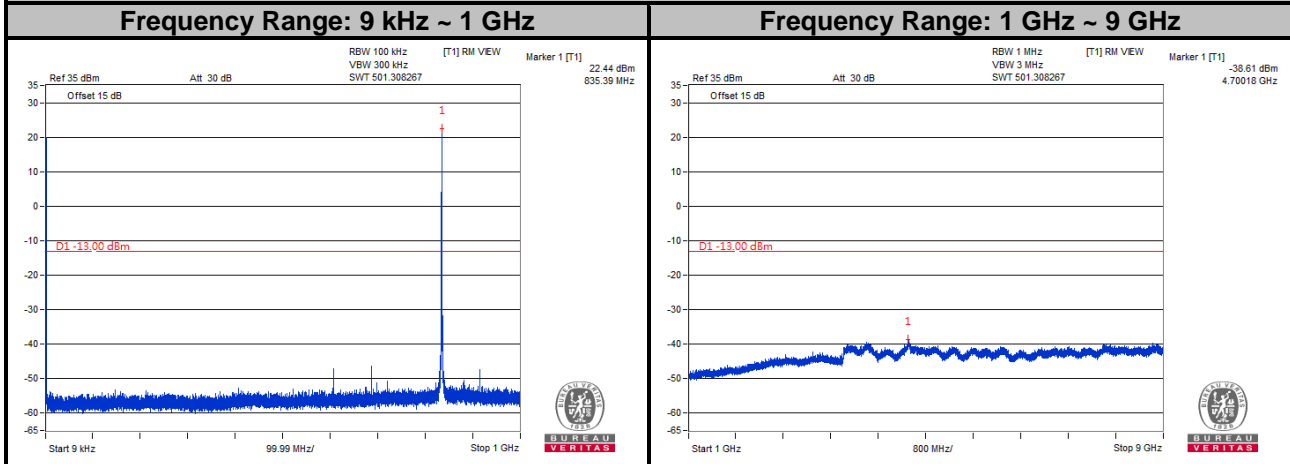

Channel 20635

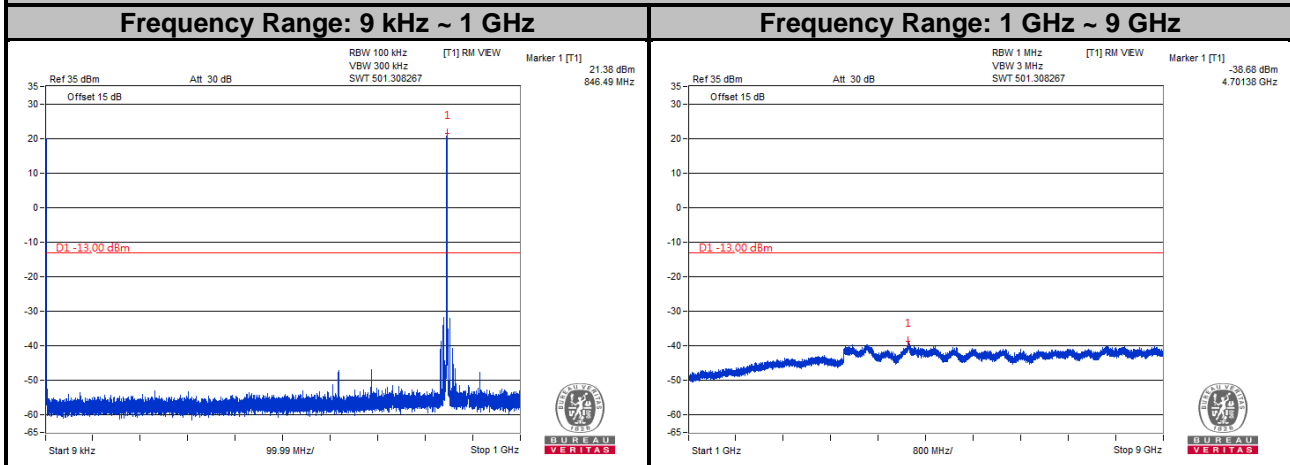

Note: The signal over the limit in 9 kHz is from spectrum analyzer.

LTE Band 5
Channel Bandwidth: 5 MHz
Channel 20425

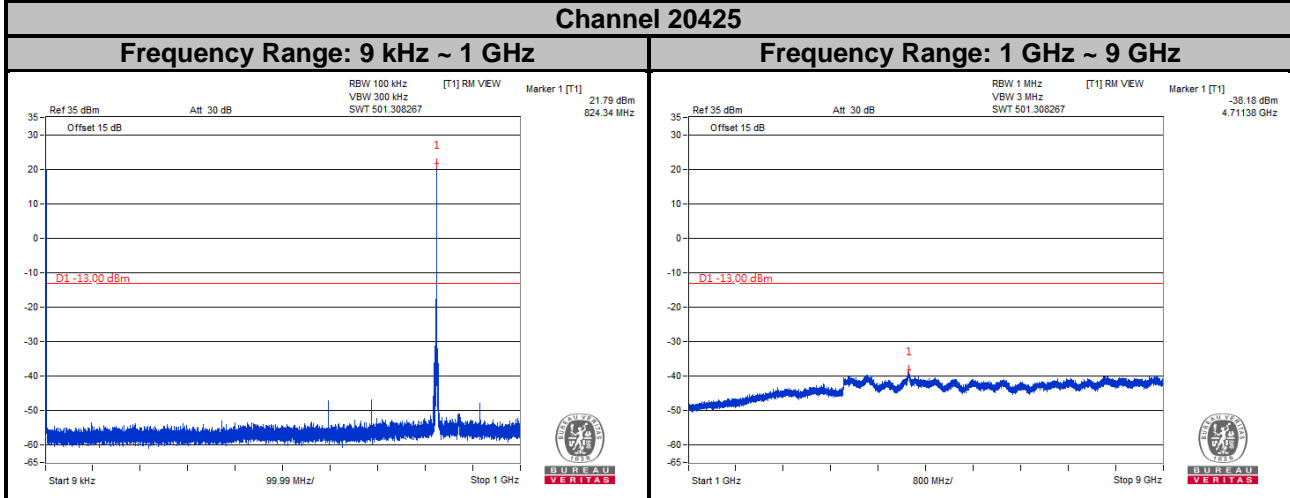

Channel 20525

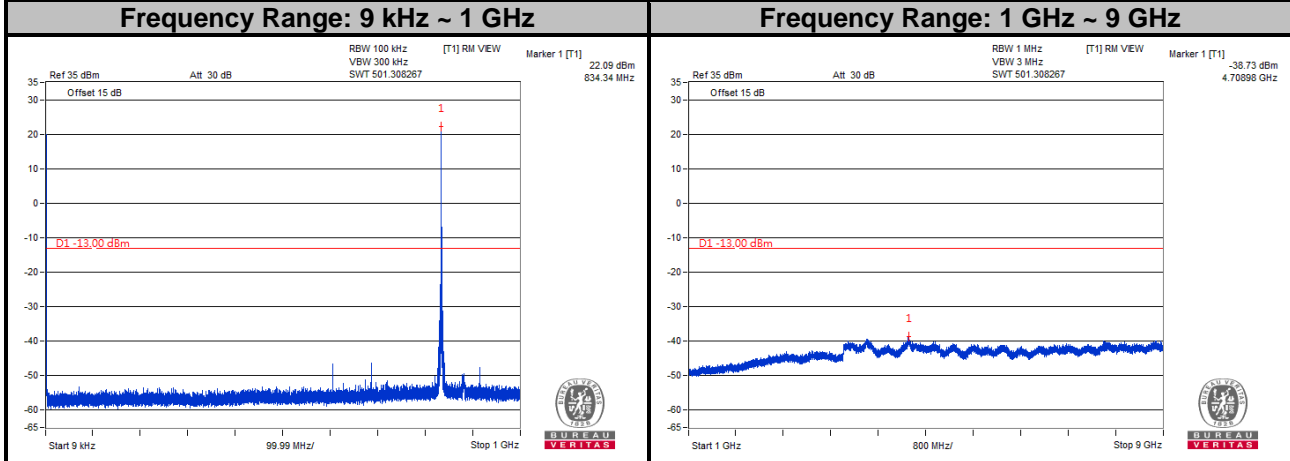

Channel 20625

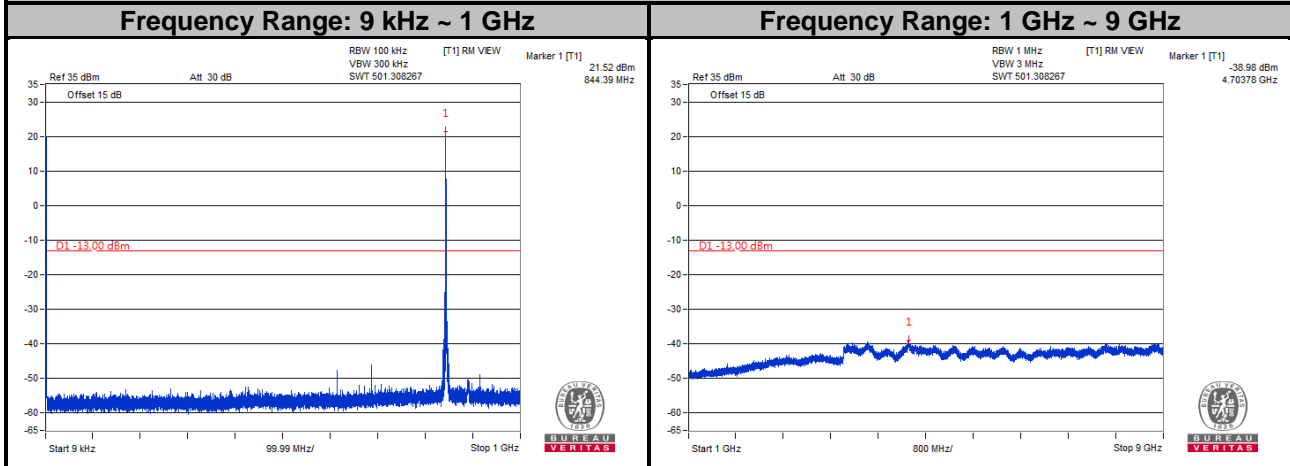

Note: The signal over the limit in 9 kHz is from spectrum analyzer.

LTE Band 5
Channel Bandwidth: 10 MHz

Channel 20450

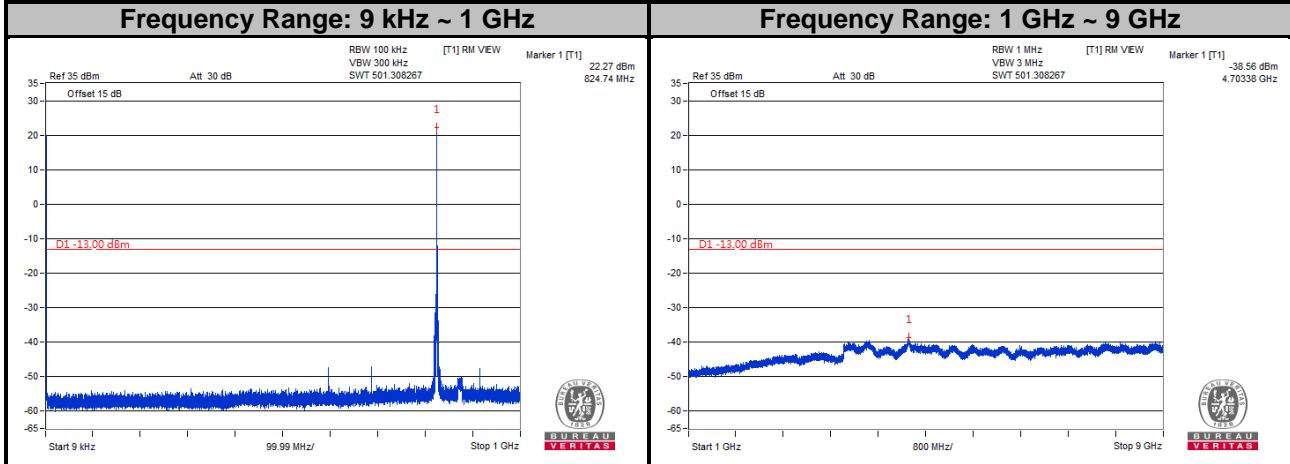

Channel 20525

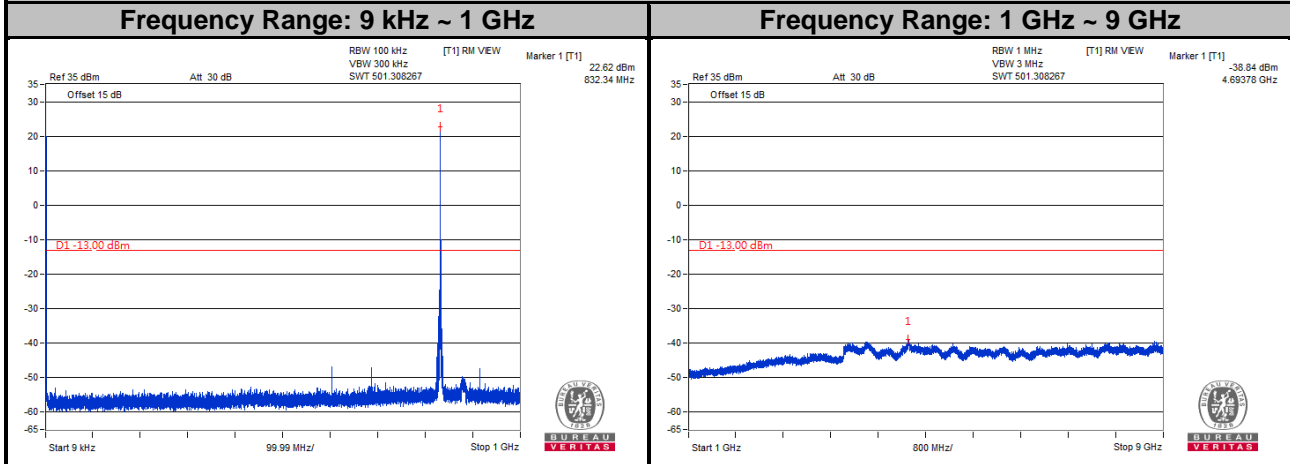

Channel 20600

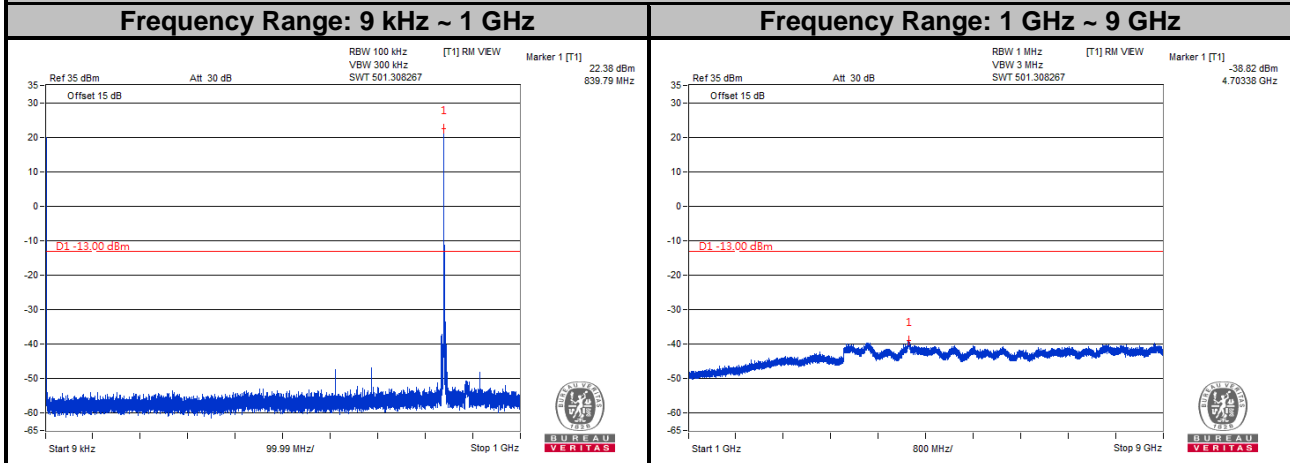

Note: The signal over the limit in 9 kHz is from spectrum analyzer.

LTE Band 26
Channel Bandwidth: 1.4 MHz
Channel 26797

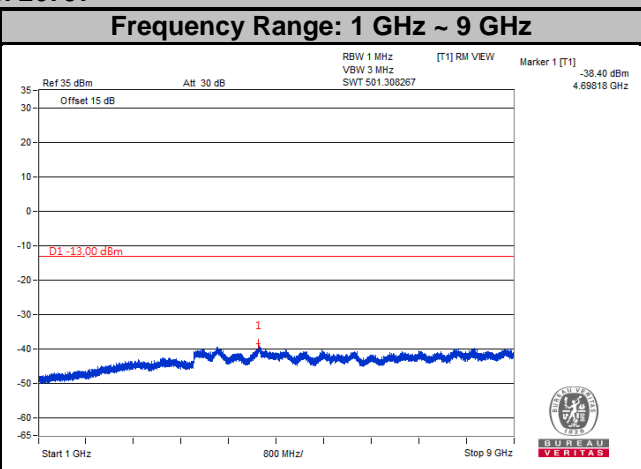
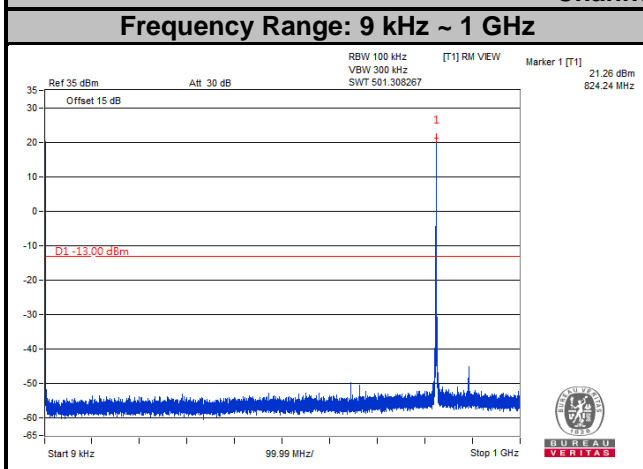

Channel 26915

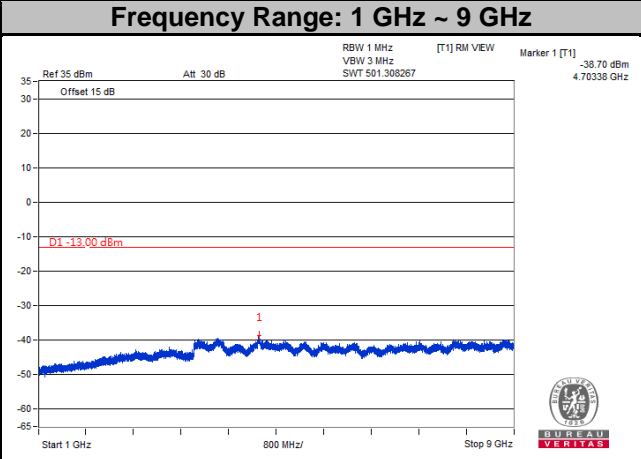
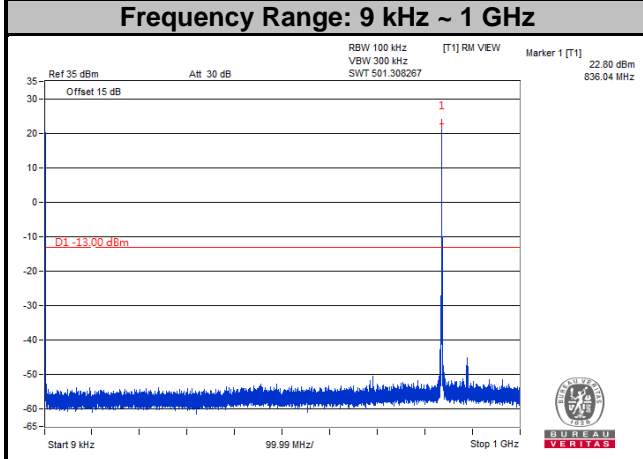

Channel 27033

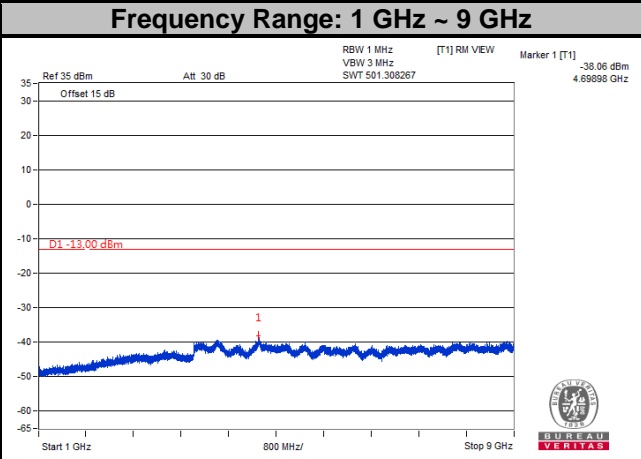
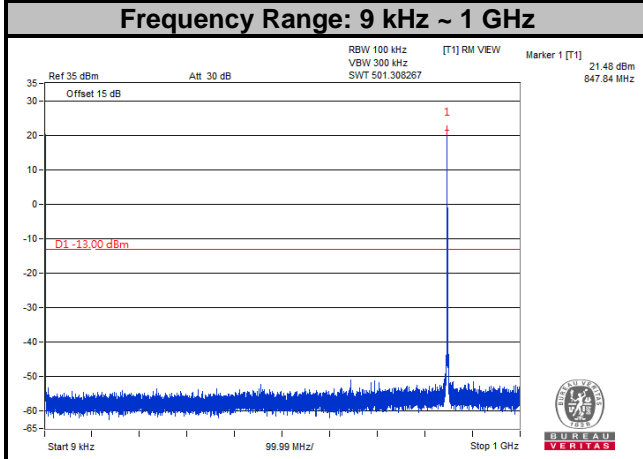

Note: The signal over the limit in 9 kHz is from spectrum analyzer.

LTE Band 26
Channel Bandwidth: 3 MHz
Channel 26805

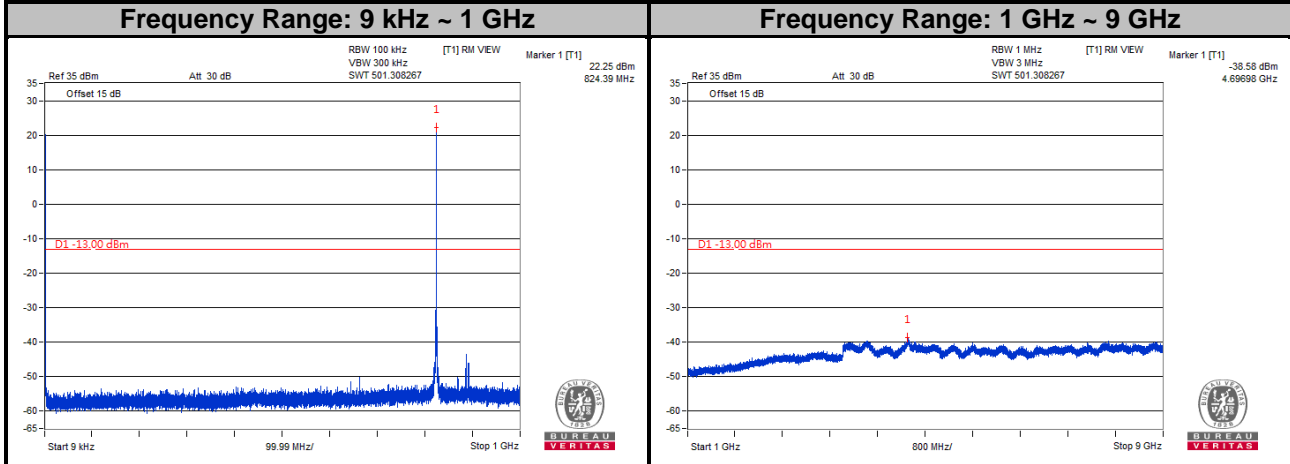

Channel 26915

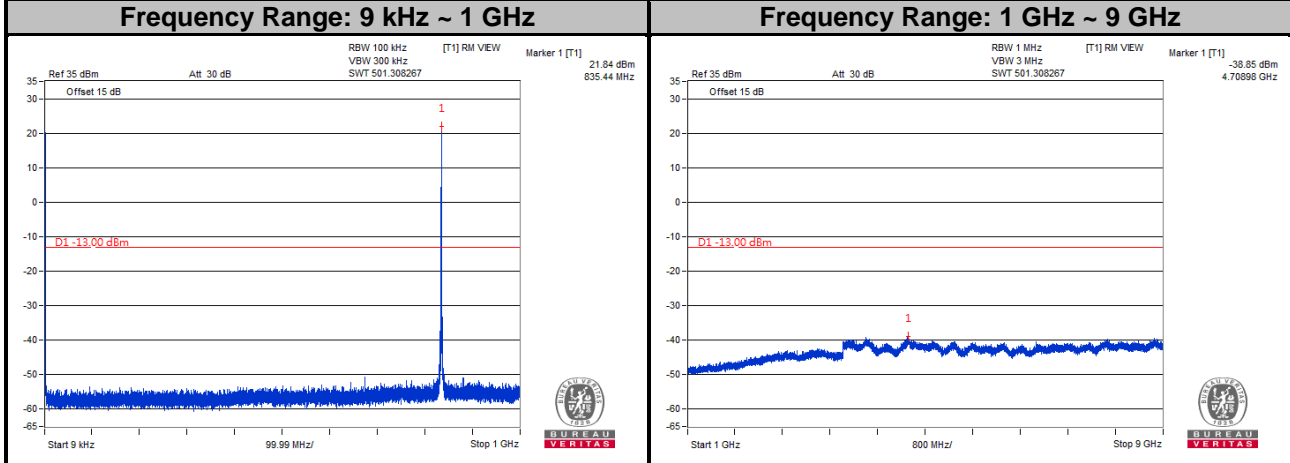

Channel 27025

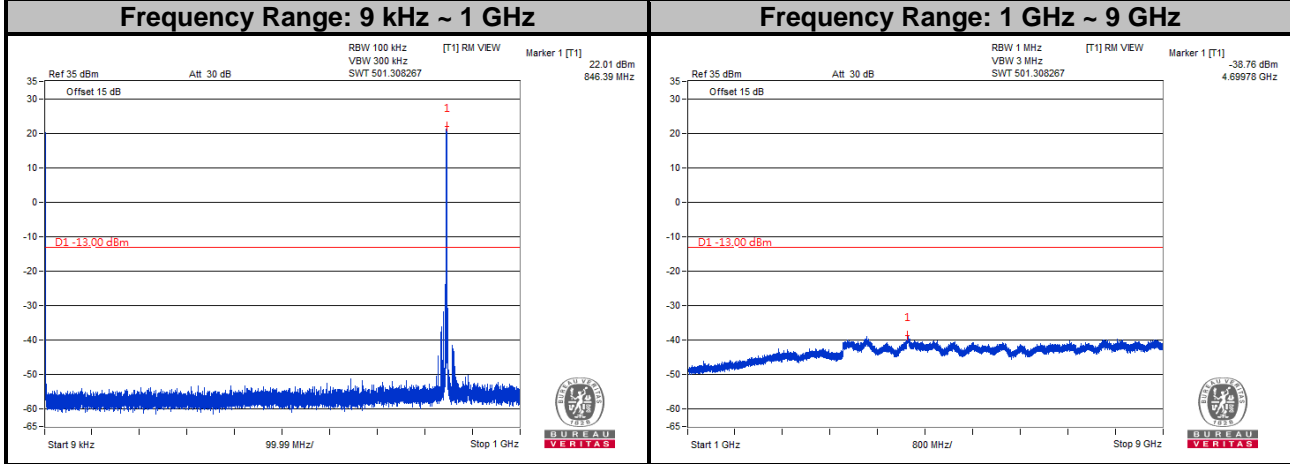

Note: The signal over the limit in 9 kHz is from spectrum analyzer.

LTE Band 26
Channel Bandwidth: 5 MHz
Channel 26815

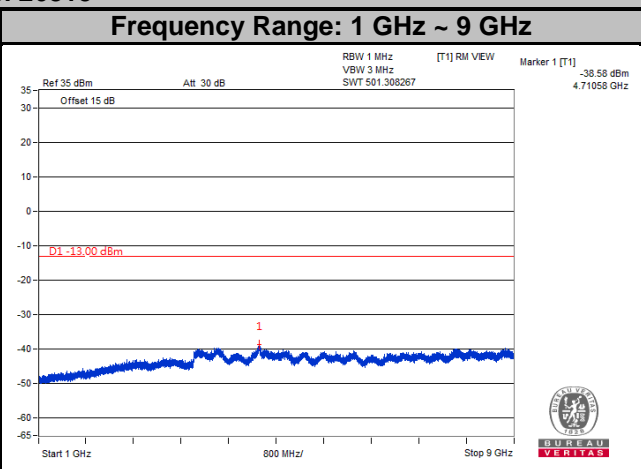
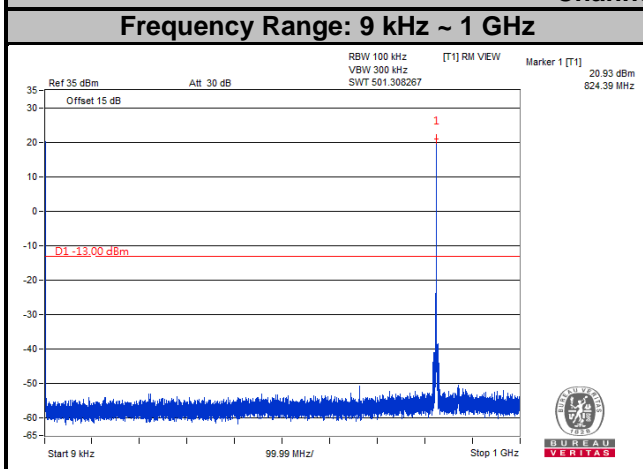

Channel 26915

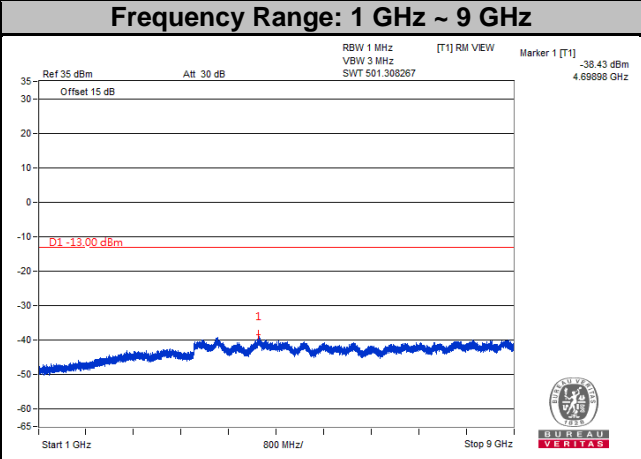
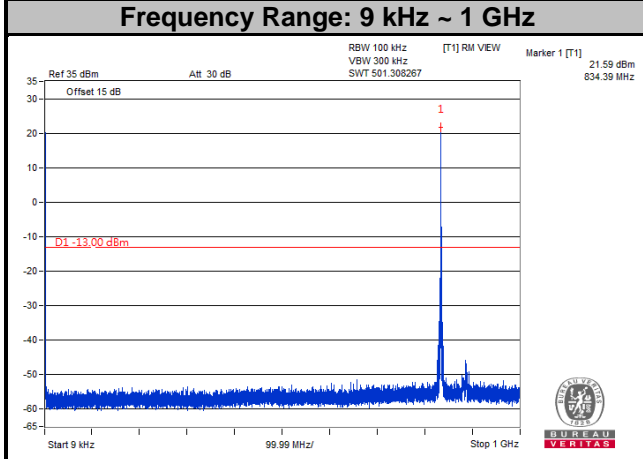

Channel 27015

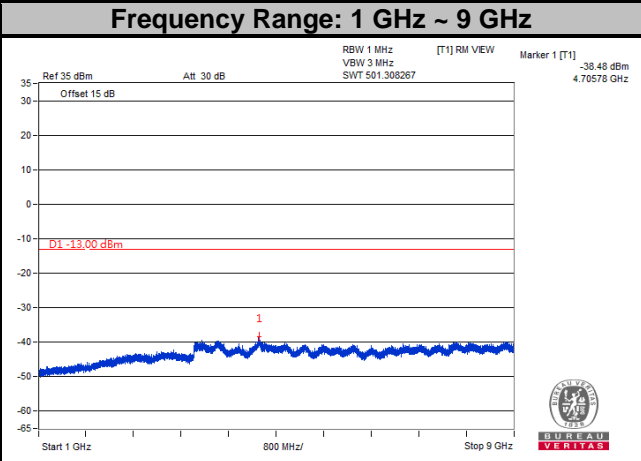
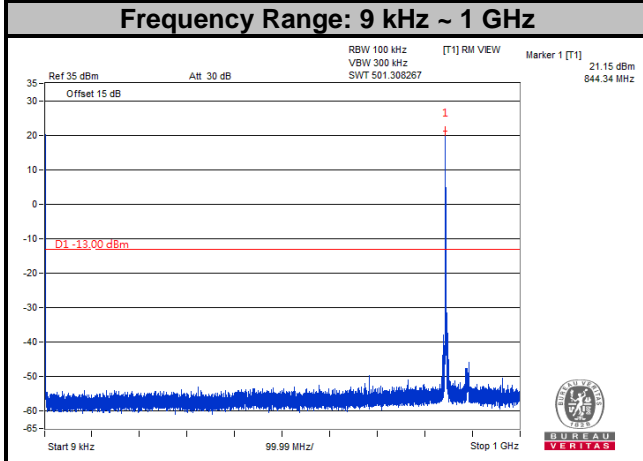

Note: The signal over the limit in 9 kHz is from spectrum analyzer.

LTE Band 26
Channel Bandwidth: 10 MHz
Channel 26840

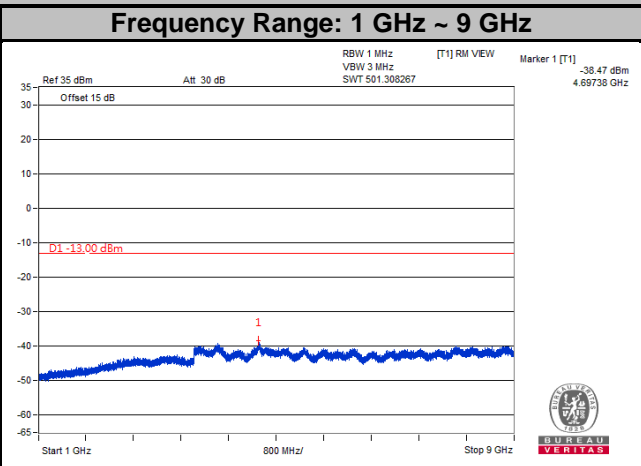
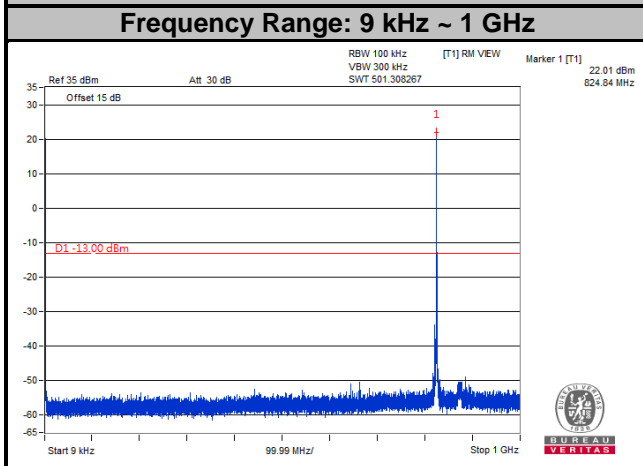

Channel 26915

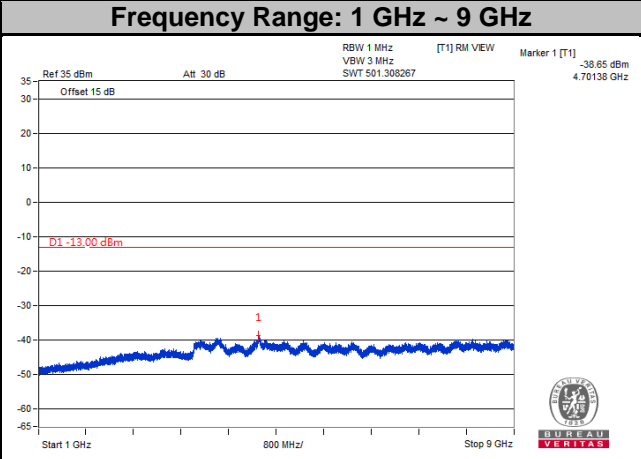
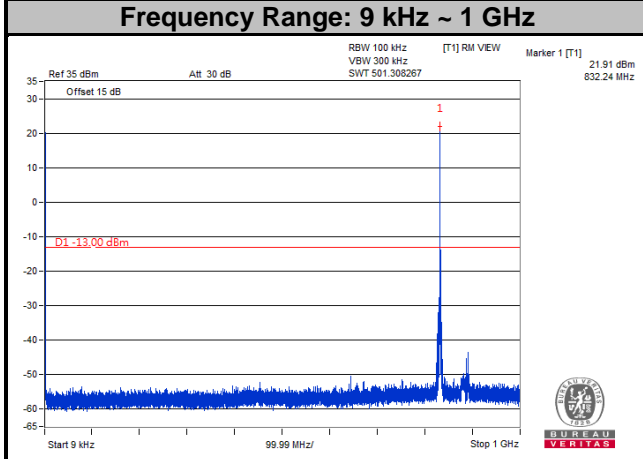

Channel 26990

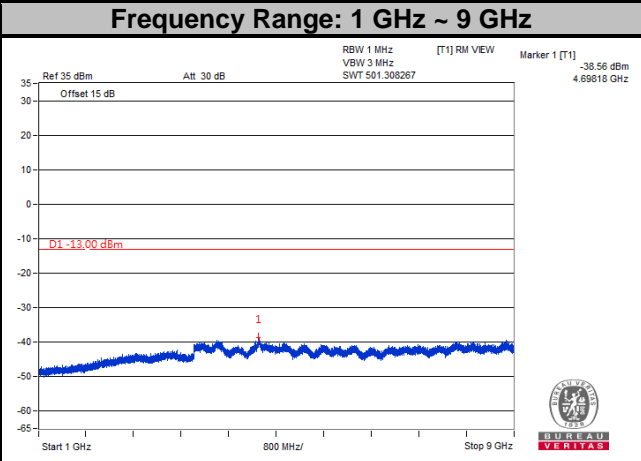
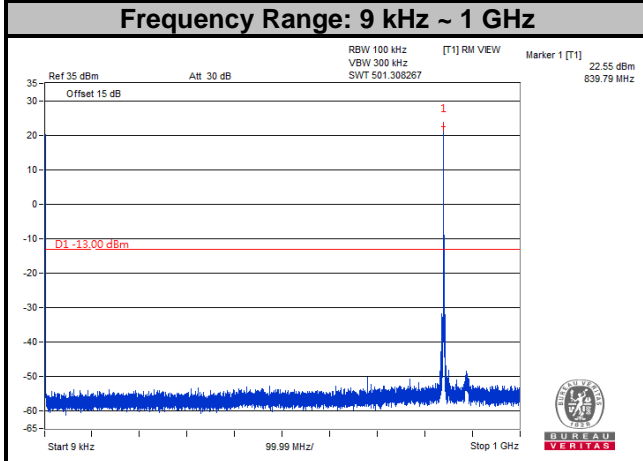

Note: The signal over the limit in 9 kHz is from spectrum analyzer.

LTE Band 26
Channel Bandwidth: 15 MHz
Channel 26865

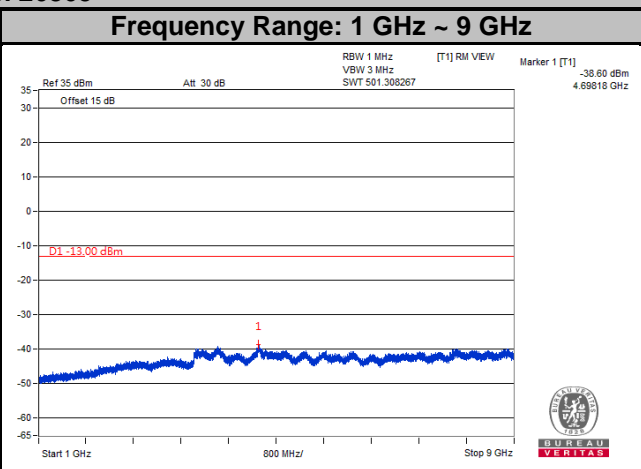
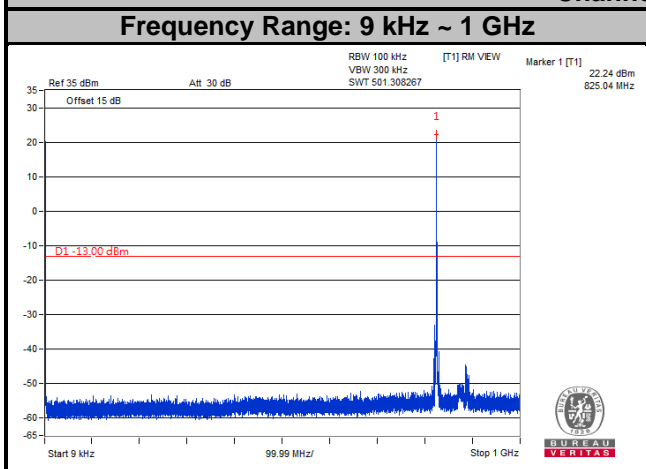

Channel 26915

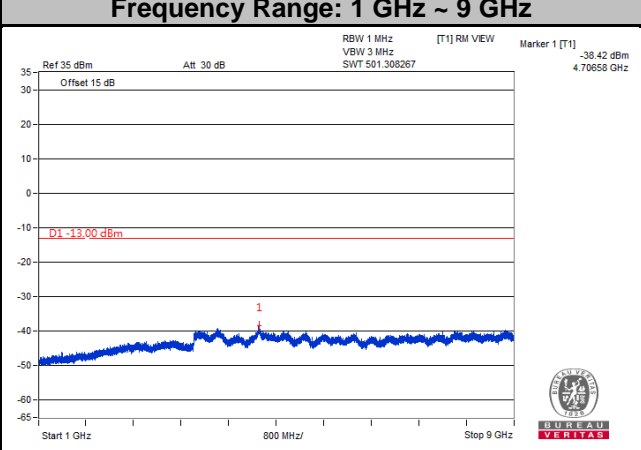
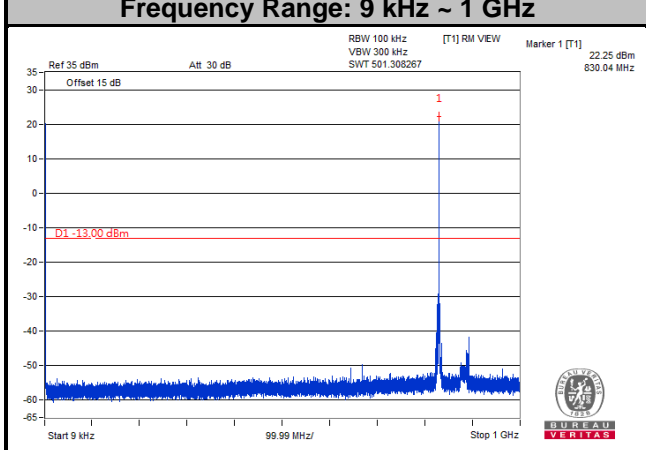

Channel 26965

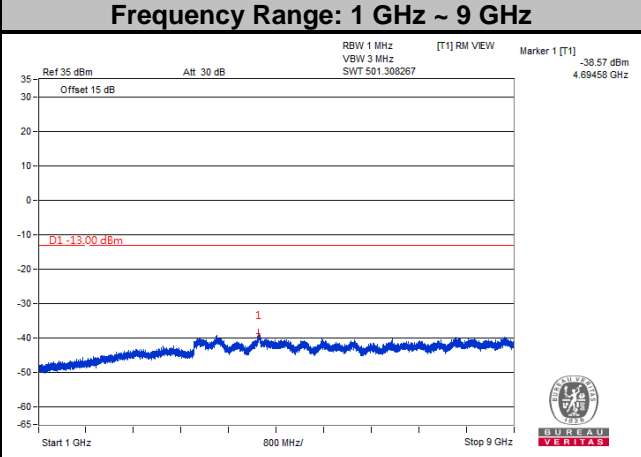
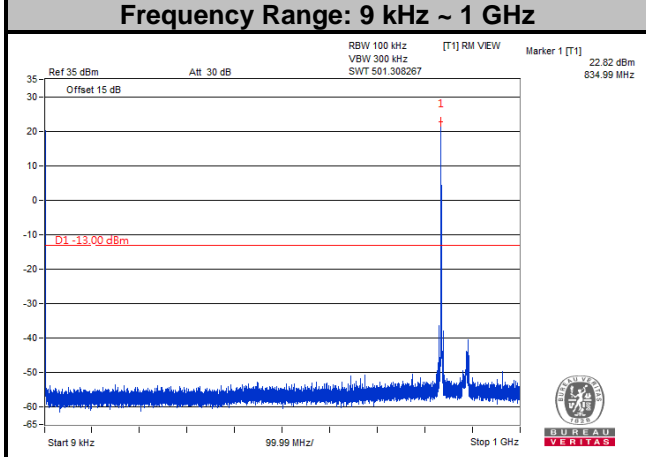

Note: The signal over the limit in 9 kHz is from spectrum analyzer.

NB-IoT

LTE Band 5
Channel 20402

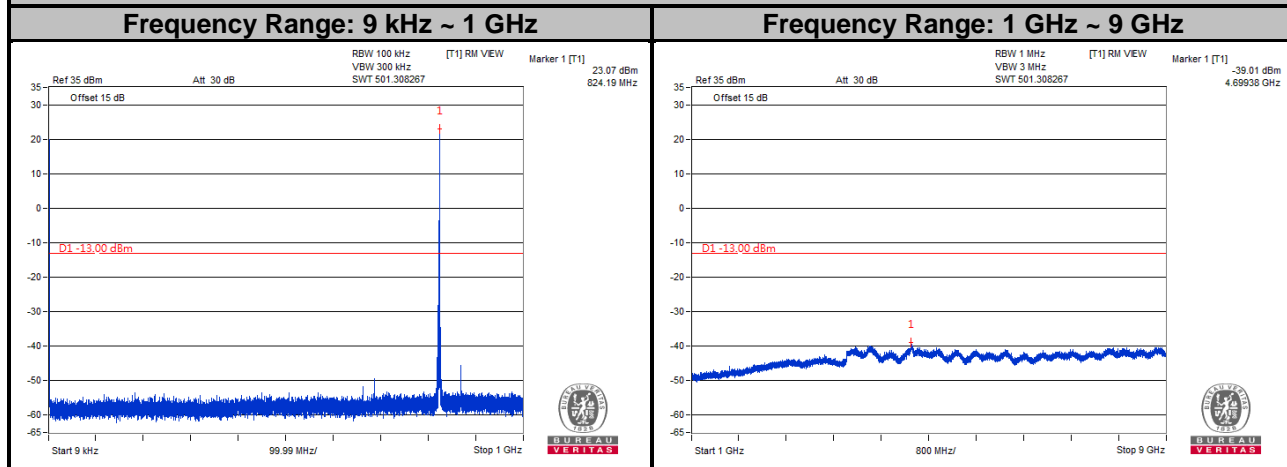

Channel 20525

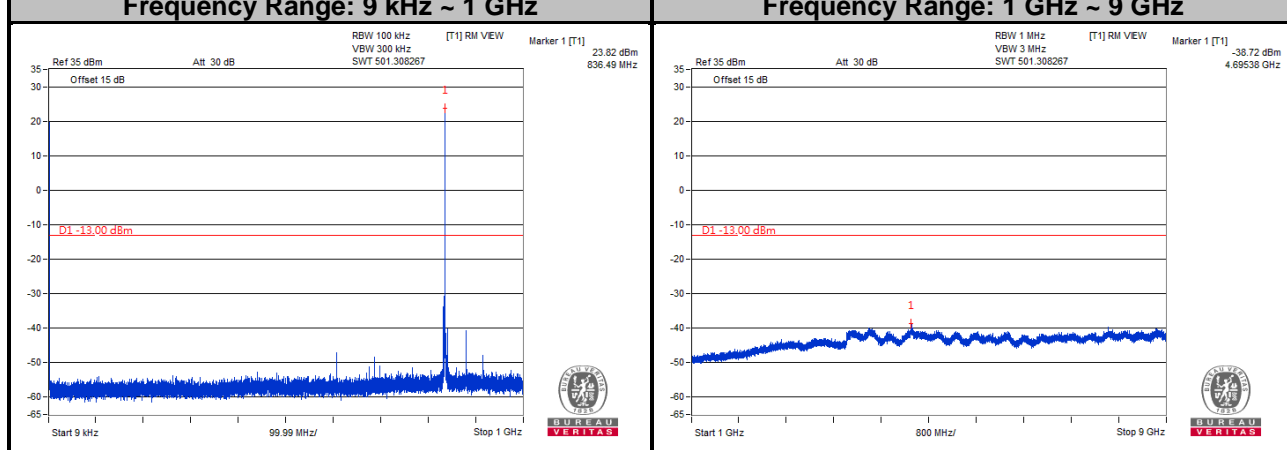

Channel 20648

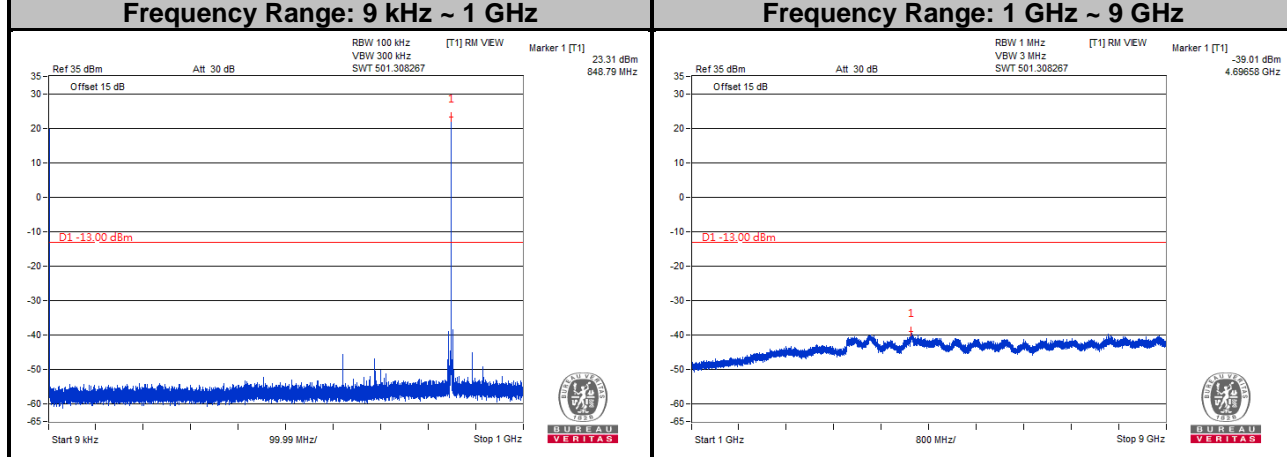

Note: The signal over the limit in 9 kHz is from spectrum analyzer.

LTE Band 26

Channel 26792

Frequency Range: 9 kHz ~ 1 GHz

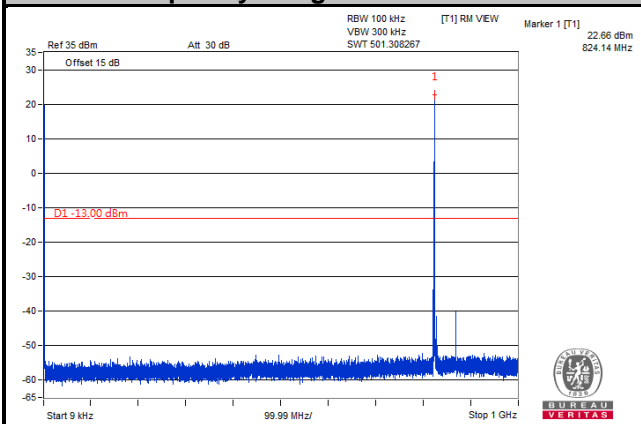

Frequency Range: 1 GHz ~ 9 GHz

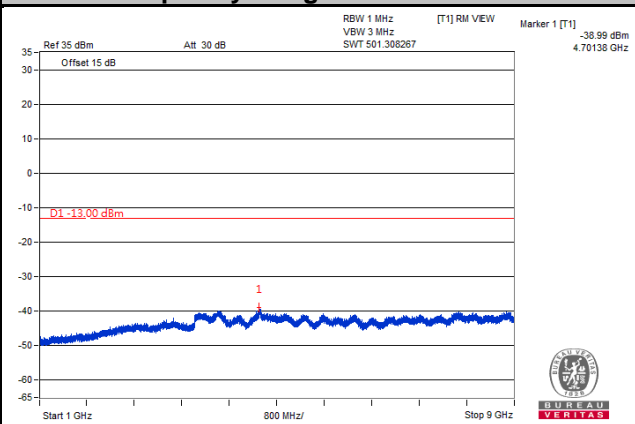

Channel 26915

Frequency Range: 9 kHz ~ 1 GHz

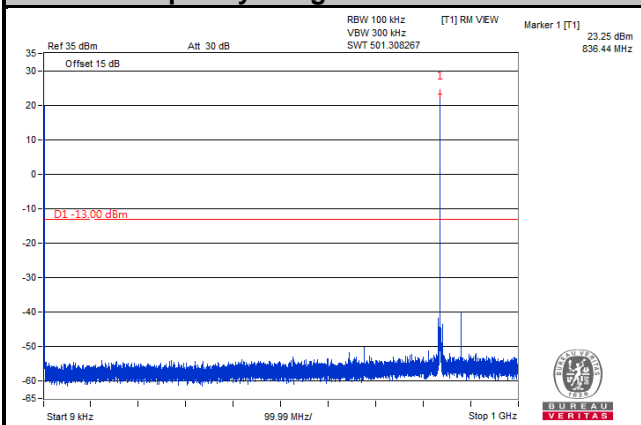

Frequency Range: 1 GHz ~ 9 GHz

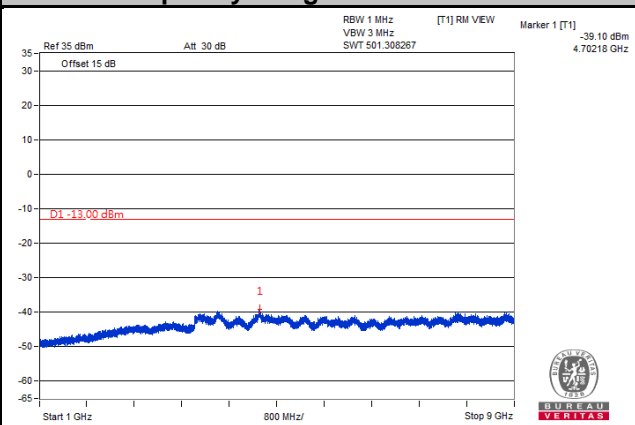

Channel 27038

Frequency Range: 9 kHz ~ 1 GHz

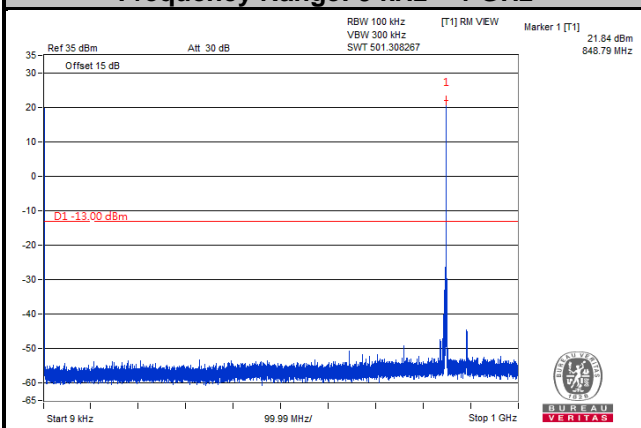

Frequency Range: 1 GHz ~ 9 GHz

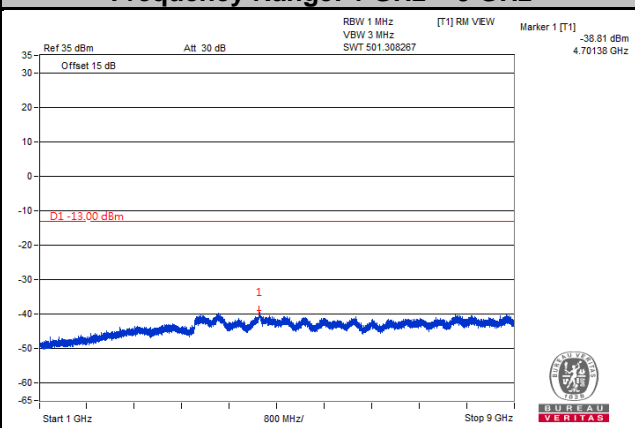

Note: The signal over the limit in 9 kHz is from spectrum analyzer.

4.8 Radiated Emission Measurement

4.8.1 Limits of Radiated Emission Measurement

The power of any emission outside of the authorized operating frequency ranges must be attenuated below the transmitting power (P) by a factor of at least $43 + 10 \log(P)$ dB. The emission limit is equal to -13 dBm.

4.8.2 Test Procedure

- a. Substitution method is used for E.I.R.P measurement. In the semi-anechoic chamber, EUT placed on the 0.8 m (below or equal 1 GHz) and/or 1.5 m (above 1 GHz) height of Turn Table, rotated the table around 360 degrees to search the maximum radiation power and receiver antenna shall be rotated vertical and horizontal polarization and moved height from 1 m to 4 m to find the maximum polar radiated power. The "Read Value" is the spectrum reading the maximum power value.
- b. The substitution horn antenna is substituted for EUT at the same position and signals generator export the CW signal to the substitution antenna via a TX cable. Rotated the Turn Table and moved receiving antenna to find the maximum radiation power. Adjust output power level of S.G to get a Value of spectrum reading equal to "Read Value" of step a. Record the power level of S.G
- c. EIRP = Output power level of S.G – TX cable loss + Antenna gain of substitution horn.
- d. E.R.P power can be calculated form E.I.R.P power by subtracting the gain of dipole, E.R.P power = E.I.R.P power - 2.15 dB.

NOTE: The resolution bandwidth and video bandwidth of test receiver/spectrum analyzer is 1 MHz/3 MHz.

4.8.3 Deviation from Test Standard

No deviation.

4.8.4 Test Setup

<Radiated Emission below or equal 1 GHz>

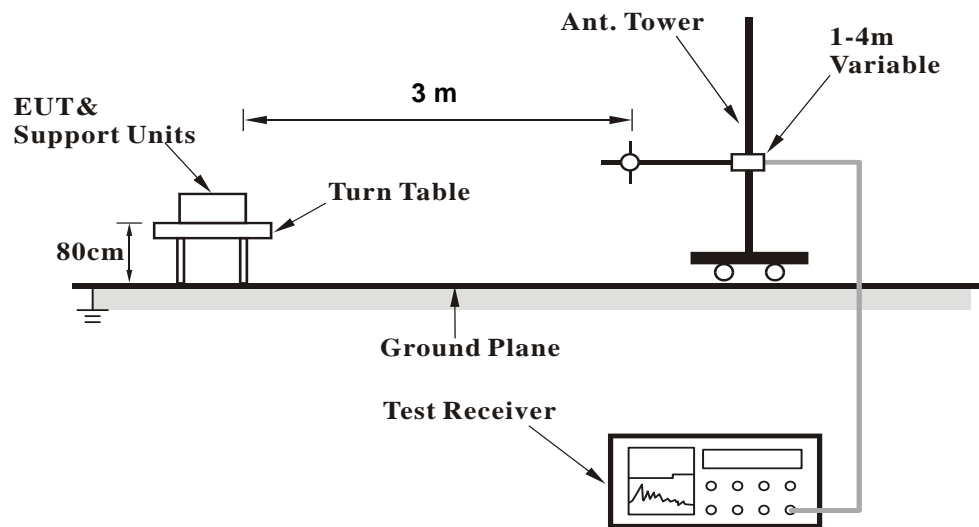

<Radiated Emission above 1 GHz>

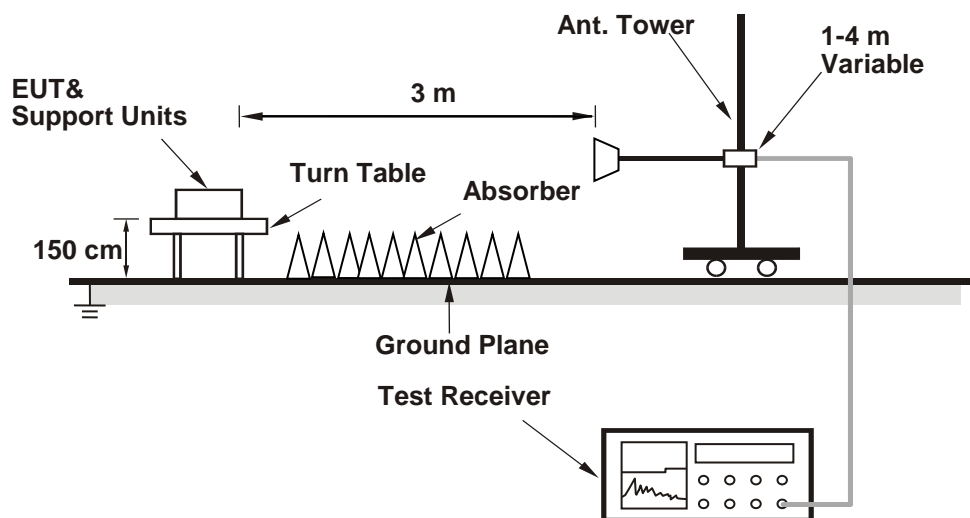

For the actual test configuration, please refer to the attached file (Test Setup Photo).

4.8.5 Test Results

Cat-M1

LTE Band 5

Channel Bandwidth: 1.4 MHz / QPSK

Low Channel



Bureau Veritas Consumer Products Services Ltd., Taoyuan Branch

A D T

Data: 3

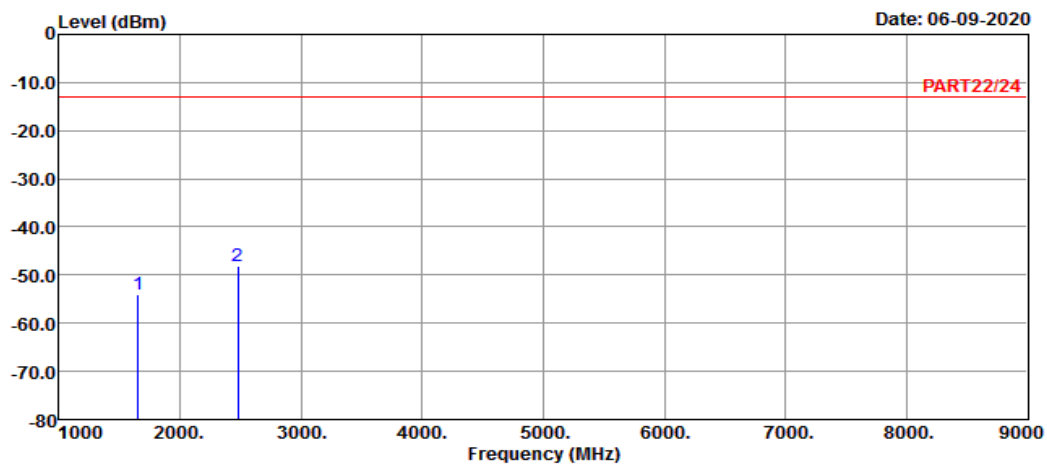

Site : 966 Chamber 5
 Condition: PART22/24 HORIZONTAL
 Remak : Cat-M1 Band 5 QPSK_1.4M Link_L-CH
 Tested by: Jisyong Wang

	Freq	Level	Read Level	Limit	Line Factor	Over Limit	Remark
	MHz	dBm	dBm	dBm	dB	dB	
1	1649.40	-54.12	-40.38	-13.00	-13.74	-41.12	Peak
2 pp	2474.10	-48.13	-38.11	-13.00	-10.02	-35.13	Peak



Bureau Veritas Consumer Products Services Ltd., Taoyuan Branch

A D T

Data: 4

Date: 06-09-2020

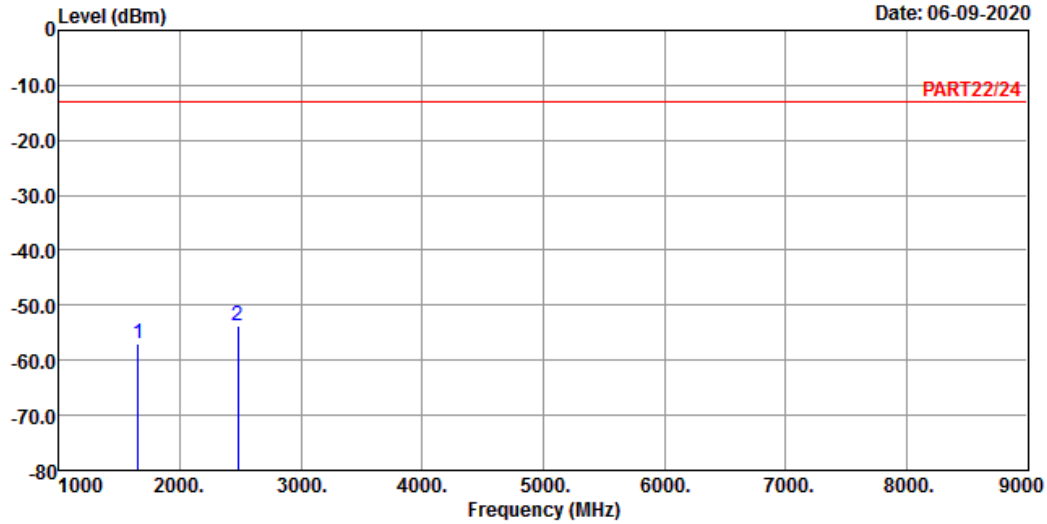

Site : 966 Chamber 5
 Condition: PART22/24 VERTICAL
 Remak : Cat-M1 Band 5 QPSK_1.4M Link_L-CH
 Tested by: Jisyong Wang

	Freq	Level	Read Level	Limit	Line Factor	Over Limit	Remark
	MHz	dBm	dBm	dBm	dB	dB	
1	1649.40	-56.85	-43.11	-13.00	-13.74	-43.85	Peak
2	pp 2474.10	-53.65	-43.63	-13.00	-10.02	-40.65	Peak

Middle Channel



Bureau Veritas Consumer Products Services Ltd., Taoyuan Branch

A D T

Data: 3

Date: 06-09-2020

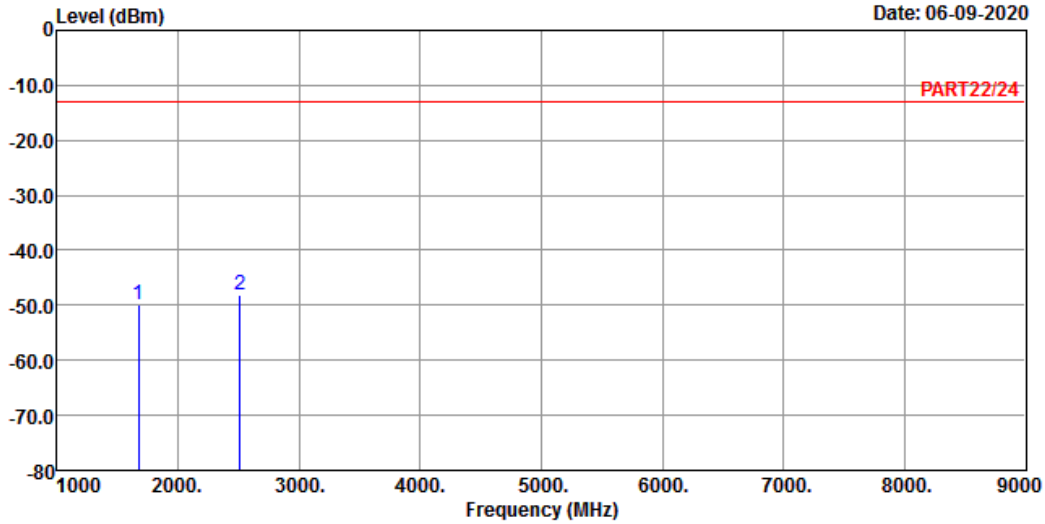

Site : 966 Chamber 5
 Condition: PART22/24 HORIZONTAL
 Remak : Cat-M1 Band 5 QPSK_1.4M Link_M-CH
 Tested by: Jisyong Wang

	Read	Limit	Over			
Freq	Level	Level	Line	Factor	Limit	Remark
MHz	dBm	dBm	dBm	dB	dB	
1	1673.00	-49.99	-36.09	-13.00	-13.90	-36.99 Peak
2 pp	2509.50	-48.23	-38.15	-13.00	-10.08	-35.23 Peak



Bureau Veritas Consumer Products Services Ltd., Taoyuan Branch

A D T

Data: 4

Date: 06-09-2020

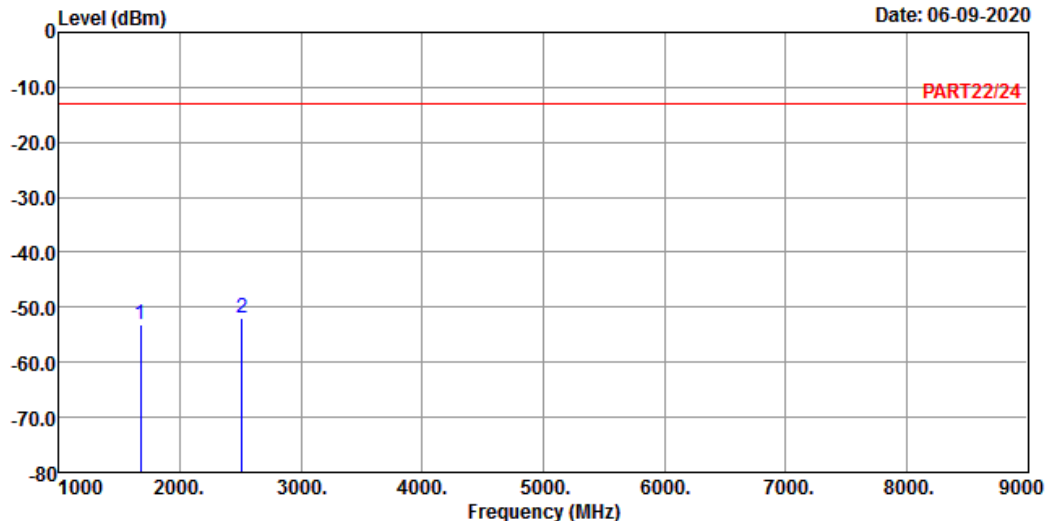

Site : 966 Chamber 5
 Condition: PART22/24 VERTICAL
 Remak : Cat-M1 Band 5 QPSK_1.4M Link_M-CH
 Tested by: Jisyong Wang

	Freq	Level	Read Level	Limit	Line Factor	Over Limit	Remark
	MHz	dBm	dBm	dBm	dB	dB	
1	1673.00	-53.26	-39.36	-13.00	-13.90	-40.26	Peak
2	pp 2509.50	-51.85	-41.77	-13.00	-10.08	-38.85	Peak

High Channel



Bureau Veritas Consumer Products Services Ltd., Taoyuan Branch

A D T

Data: 7

Date: 06-09-2020

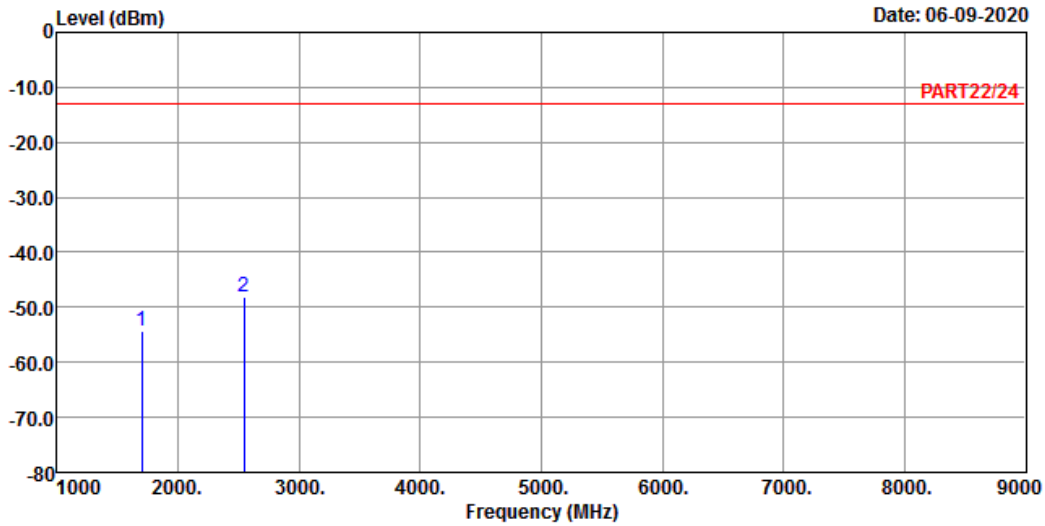

Site : 966 Chamber 5
 Condition: PART22/24 HORIZONTAL
 Remak : Cat-M1 Band 5 QPSK_1.4M Link_H-CH
 Tested by: Jisyong Wang

	Freq	Level	Read Level	Limit	Line Factor	Over Limit	Remark
	MHz	dBm	dBm	dBm	dB	dB	
1	1696.60	-54.23	-40.21	-13.00	-14.02	-41.23	Peak
2 pp	2544.90	-47.99	-37.93	-13.00	-10.06	-34.99	Peak



Bureau Veritas Consumer Products Services Ltd., Taoyuan Branch

A D T

Data: 8

Date: 06-09-2020

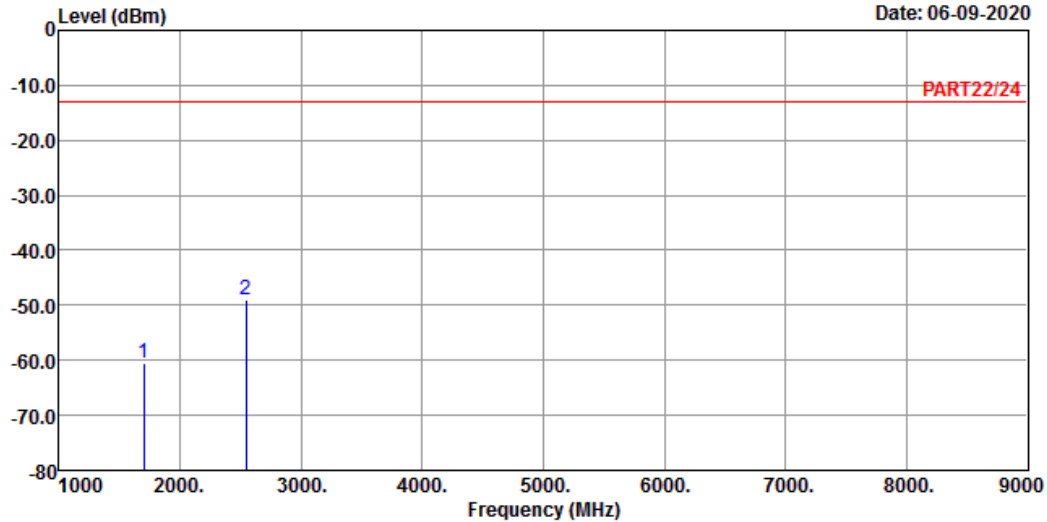

Site : 966 Chamber 5
 Condition: PART22/24 VERTICAL
 Remak : Cat-M1 Band 5 QPSK_1.4M Link_H-CH
 Tested by: Jisyong Wang

	Freq	Level	Read Level	Limit	Line Factor	Over Limit	Remark
	MHz	dBm	dBm	dBm	dB	dB	
1	1696.60	-60.56	-46.54	-13.00	-14.02	-47.56	Peak
2	pp 2544.90	-49.11	-39.05	-13.00	-10.06	-36.11	Peak

Channel Bandwidth: 5 MHz / QPSK
Low Channel



Bureau Veritas Consumer Products Services Ltd., Taoyuan Branch

A D T

Data: 3

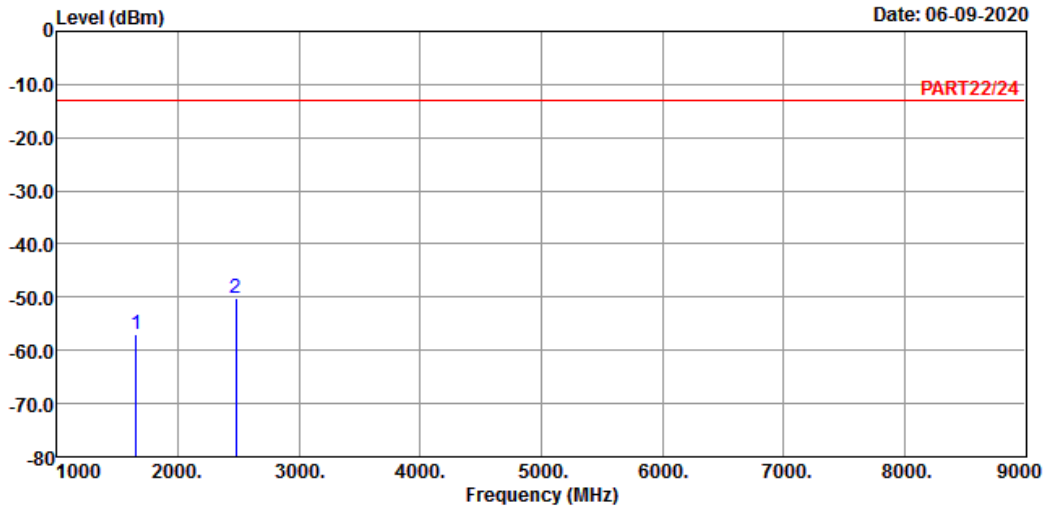

Site : 966 Chamber 5
Condition: PART22/24 VERTICAL
Remak : Cat-M1 Band 5 QPSK_5M Link_L-CH
Tested by: Jisyong Wang

	Freq	Level	Read Level	Limit	Line Factor	Over Limit	Remark
	MHz	dBm	dBm	dBm	dB	dB	
1	1653.00	-56.95	-43.18	-13.00	-13.77	-43.95	Peak
2 pp	2479.50	-50.29	-40.26	-13.00	-10.03	-37.29	Peak



Bureau Veritas Consumer Products Services Ltd., Taoyuan Branch

A D T

Data: 4

Date: 06-09-2020

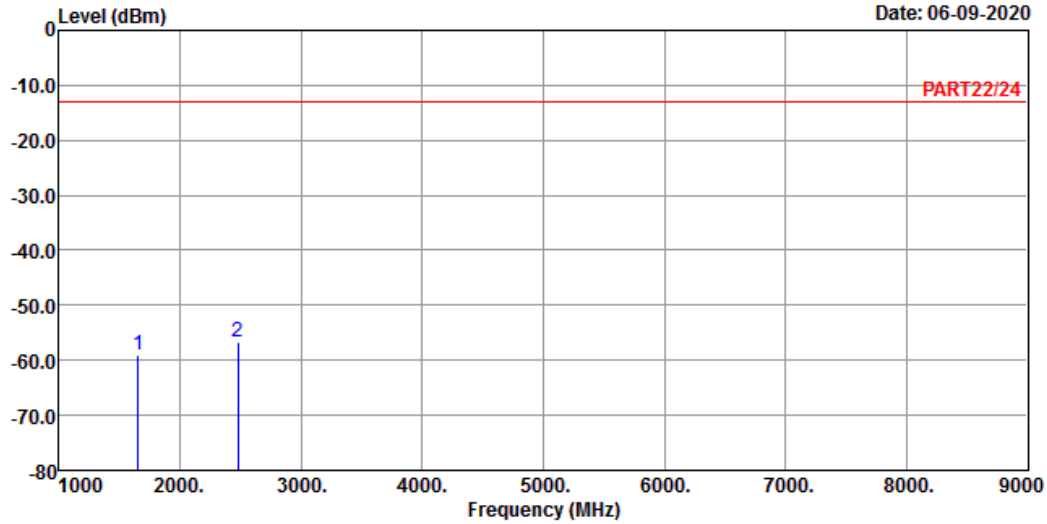

Site : 966 Chamber 5
 Condition: PART22/24 VERTICAL
 Remak : Cat-M1 Band 5 QPSK_5M Link_L-CH
 Tested by: Jisyong Wang

	Freq	Level	Read Level	Limit	Line Factor	Over Limit	Remark
	MHz	dBm	dBm	dBm	dB	dB	
1	1653.00	-59.13	-45.36	-13.00	-13.77	-46.13	Peak
2	pp 2479.50	-56.75	-46.72	-13.00	-10.03	-43.75	Peak

Middle Channel



Bureau Veritas Consumer Products Services Ltd., Taoyuan Branch

A D T

Data: 3

Date: 06-09-2020

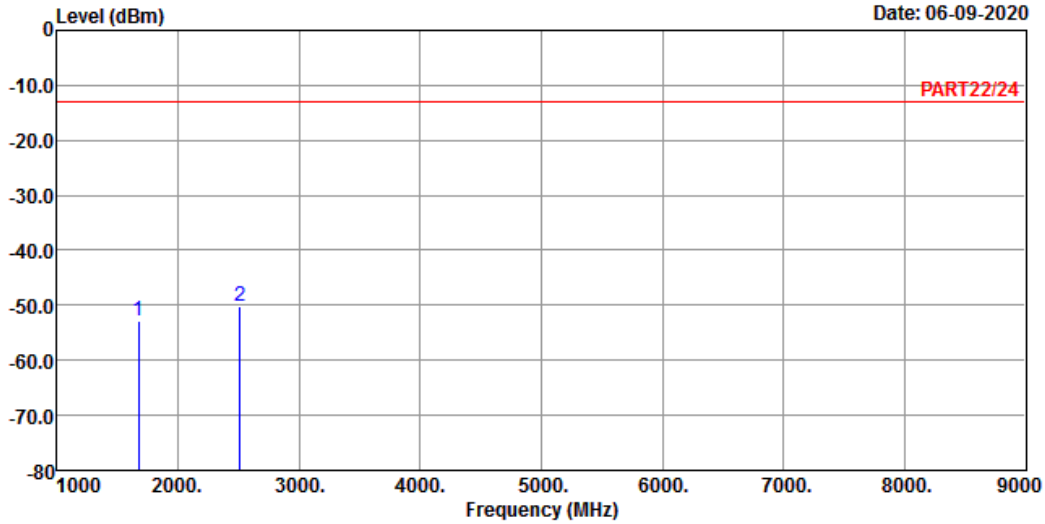

Site : 966 Chamber 5
 Condition: PART22/24 VERTICAL
 Remak : Cat-M1 Band 5 QPSK_5M Link_M-CH
 Tested by: Jisyong Wang

	Freq	Level	Read Level	Limit	Line Factor	Over Limit	Remark
	MHz	dBm	dBm	dBm	dB	dB	
1	1673.00	-52.89	-38.99	-13.00	-13.90	-39.89	Peak
2 pp	2509.50	-50.13	-40.05	-13.00	-10.08	-37.13	Peak



Bureau Veritas Consumer Products Services Ltd., Taoyuan Branch

A D T

Data: 4

Date: 06-09-2020

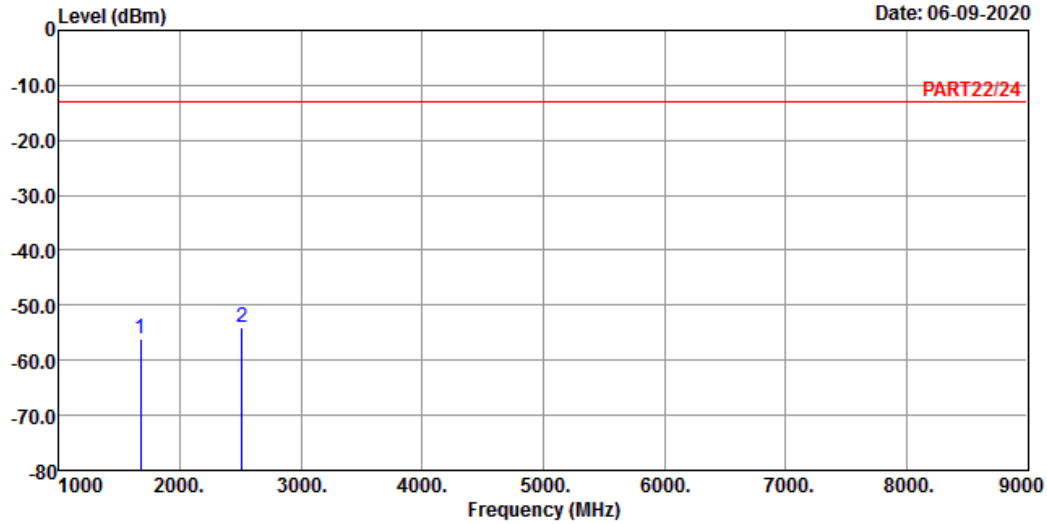

Site : 966 Chamber 5
 Condition: PART22/24 VERTICAL
 Remak : Cat-M1 Band 5 QPSK_5M Link_M-CH
 Tested by: Jisyong Wang

	Freq	Level	Read Level	Limit	Line Factor	Over Limit	Remark
	MHz	dBm	dBm	dBm	dB	dB	
1	1673.00	-56.12	-42.22	-13.00	-13.90	-43.12	Peak
2	2509.50	-54.16	-44.08	-13.00	-10.08	-41.16	Peak

High Channel



Bureau Veritas Consumer Products Services Ltd., Taoyuan Branch

A D T

Data: 3

Date: 06-09-2020

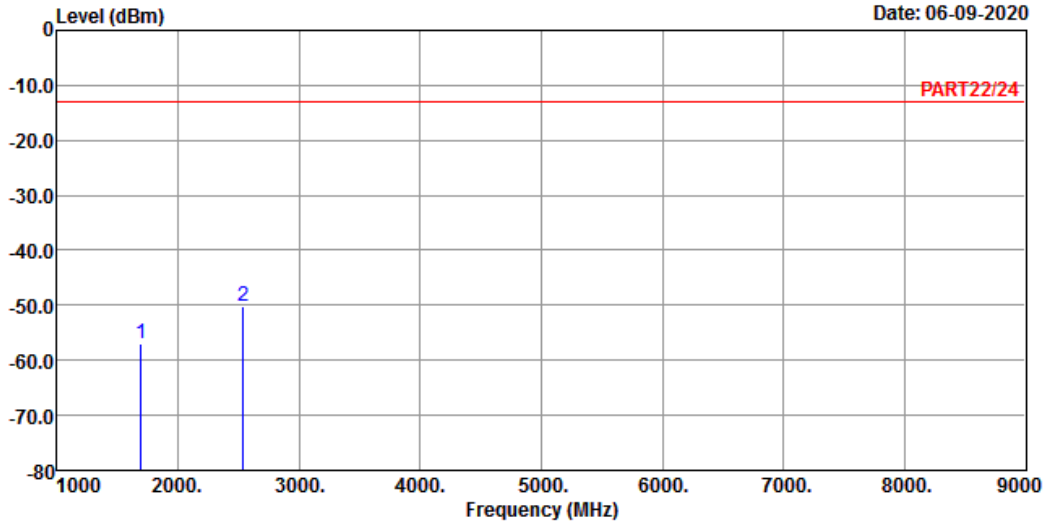

Site : 966 Chamber 5
 Condition: PART22/24 HORIZONTAL
 Remak : Cat-M1 Band 5 QPSK_5M Link_H-CH
 Tested by: Jisyong Wang

	Freq	Level	Read Level	Limit	Line Factor	Over Limit	Remark
	MHz	dBm	dBm	dBm	dB	dB	
1	1693.00	-57.12	-43.10	-13.00	-14.02	-44.12	Peak
2 pp	2539.50	-50.23	-40.17	-13.00	-10.06	-37.23	Peak



Bureau Veritas Consumer Products Services Ltd., Taoyuan Branch

A D T

Data: 4

Date: 06-09-2020

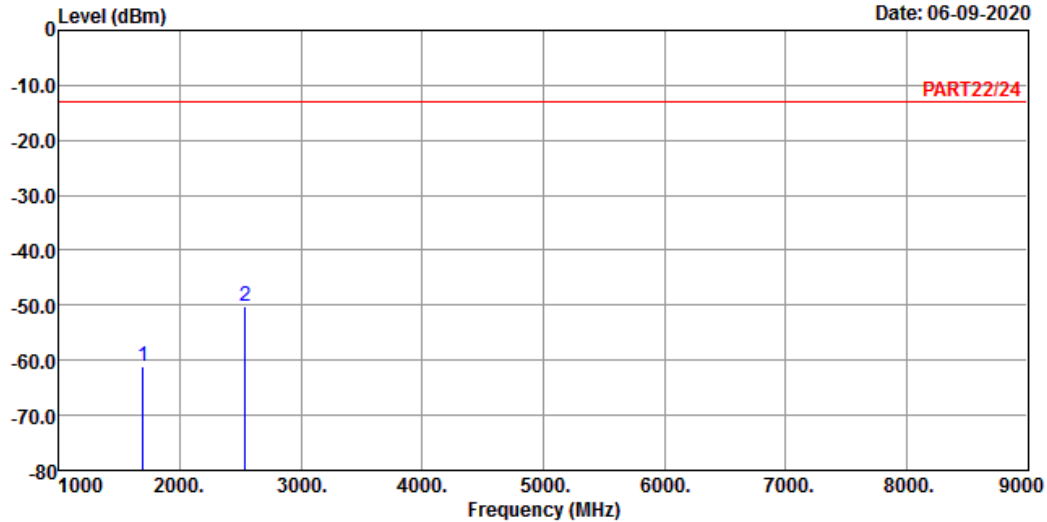

Site : 966 Chamber 5
 Condition: PART22/24 VERTICAL
 Remak : Cat-M1 Band 5 QPSK_5M Link_H-CH
 Tested by: Jisyong Wang

	Freq	Level	Read Level	Limit	Line Factor	Over Limit	Remark
	MHz	dBm	dBm	dBm	dB	dB	
1	1693.00	-60.99	-46.97	-13.00	-14.02	-47.99	Peak
2	2539.50	-50.13	-40.07	-13.00	-10.06	-37.13	Peak

Channel Bandwidth: 10 MHz / QPSK
Low Channel



Bureau Veritas Consumer Products Services Ltd., Taoyuan Branch

A D T

Data: 3

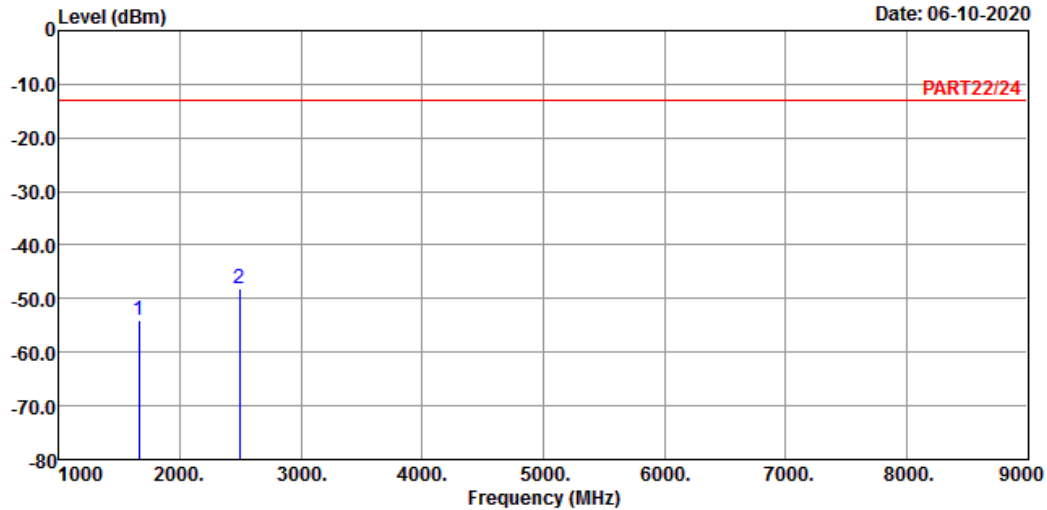

Site : 966 Chamber 5
Condition: PART22/24 VERTICAL
Remak : Cat-M1 Band 5 QPSK_10M Link_L-CH
Tested by: Jisyong Wang

	Freq	Level	Read Level	Limit	Line Factor	Over Limit	Remark
	MHz	dBm	dBm	dBm	dB	dB	
1	1658.00	-54.11	-40.31	-13.00	-13.80	-41.11	Peak
2	2487.00	-48.11	-38.06	-13.00	-10.05	-35.11	Peak



Bureau Veritas Consumer Products Services Ltd., Taoyuan Branch

A D T

Data: 4

Date: 06-10-2020

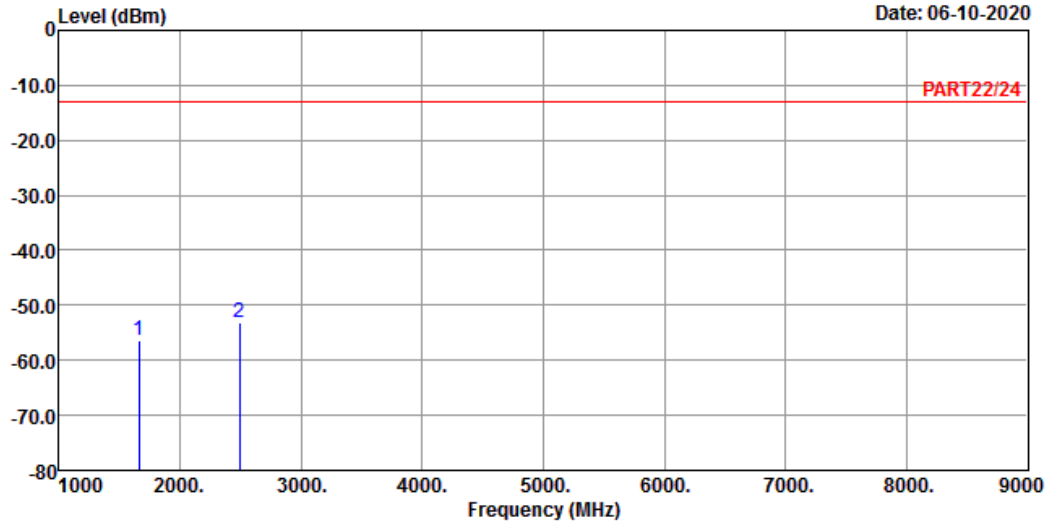

Site : 966 Chamber 5
 Condition: PART22/24 VERTICAL
 Remak : Cat-M1 Band 5 QPSK_10M Link_L-CH
 Tested by: Jisyong Wang

	Freq	Level	Read Level	Limit	Line Factor	Over Limit	Remark
	MHz	dBm	dBm	dBm	dB	dB	
1	1658.00	-56.52	-42.72	-13.00	-13.80	-43.52	Peak
2	2487.00	-53.11	-43.06	-13.00	-10.05	-40.11	Peak

Middle Channel



Bureau Veritas Consumer Products Services Ltd., Taoyuan Branch

A D T

Data: 3

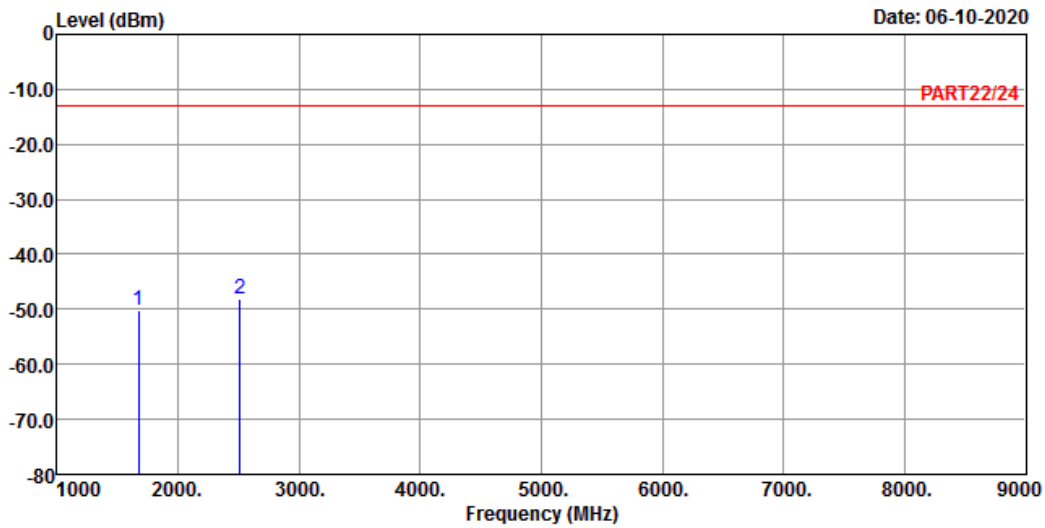

Site : 966 Chamber 5
 Condition: PART22/24 HORIZONTAL
 Remak : Cat-M1 Band 5 QPSK_10M Link_M-CH
 Tested by: Jisyong Wang

	Freq	Level	Read Level	Limit	Line Factor	Over Limit	Remark
	MHz	dBm	dBm	dBm	dB	dB	
1	1673.00	-50.11	-36.21	-13.00	-13.90	-37.11	Peak
2 pp	2509.50	-47.99	-37.91	-13.00	-10.08	-34.99	Peak



Bureau Veritas Consumer Products Services Ltd., Taoyuan Branch

A D T

Data: 4

Date: 06-10-2020

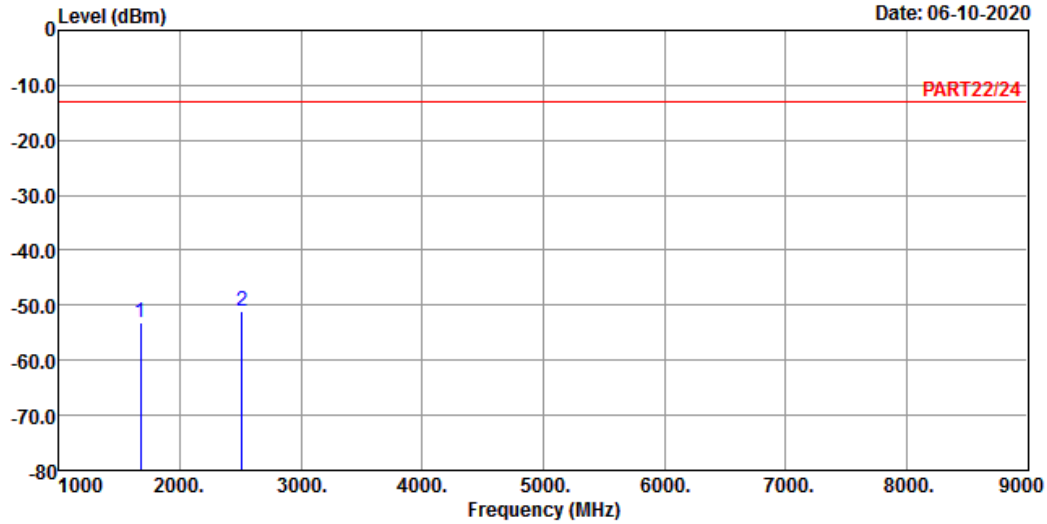

Site : 966 Chamber 5
 Condition: PART22/24 VERTICAL
 Remak : Cat-M1 Band 5 QPSK_10M Link_M-CH
 Tested by: Jisyong Wang

	Freq	Level	Read Level	Limit	Line Factor	Over Limit	Remark
	MHz	dBm	dBm	dBm	dB	dB	
1	1673.00	-53.11	-39.21	-13.00	-13.90	-40.11	Peak
2	pp 2509.50	-51.01	-40.93	-13.00	-10.08	-38.01	Peak

High Channel



Bureau Veritas Consumer Products Services Ltd., Taoyuan Branch

A D T

Data: 7

Date: 06-10-2020

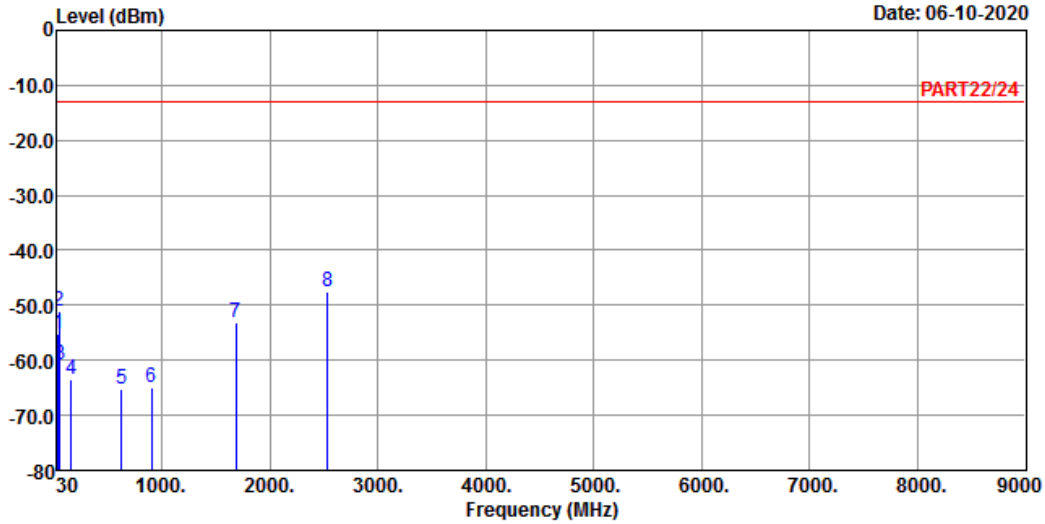

Site : 966 Chamber 5
 Condition: PART22/24 HORIZONTAL
 Remak : Cat-M1 Band 5 QPSK_10M Link_H-CH
 Tested by: Jisyong Wang

	Freq	Level	Read Level	Limit	Line	Factor	Over	Limit	Remark
	MHz	dBm	dBm	dBm		dB	dB	dB	
1	42.96	-55.25	-54.31	-13.00		-0.94	-42.25		Peak
2	45.39	-50.97	-48.47	-13.00		-2.50	-37.97		Peak
3	53.49	-60.90	-55.09	-13.00		-5.81	-47.90		Peak
4	157.44	-63.39	-57.73	-13.00		-5.66	-50.39		Peak
5	622.70	-65.31	-64.50	-13.00		-0.81	-52.31		Peak
6	907.60	-64.82	-65.58	-13.00		0.76	-51.82		Peak
7	1688.00	-53.11	-39.12	-13.00		-13.99	-40.11		Peak
8 pp	2532.00	-47.50	-37.43	-13.00		-10.07	-34.50		Peak



Bureau Veritas Consumer Products Services Ltd., Taoyuan Branch

A D T

Data: 8

Date: 06-10-2020

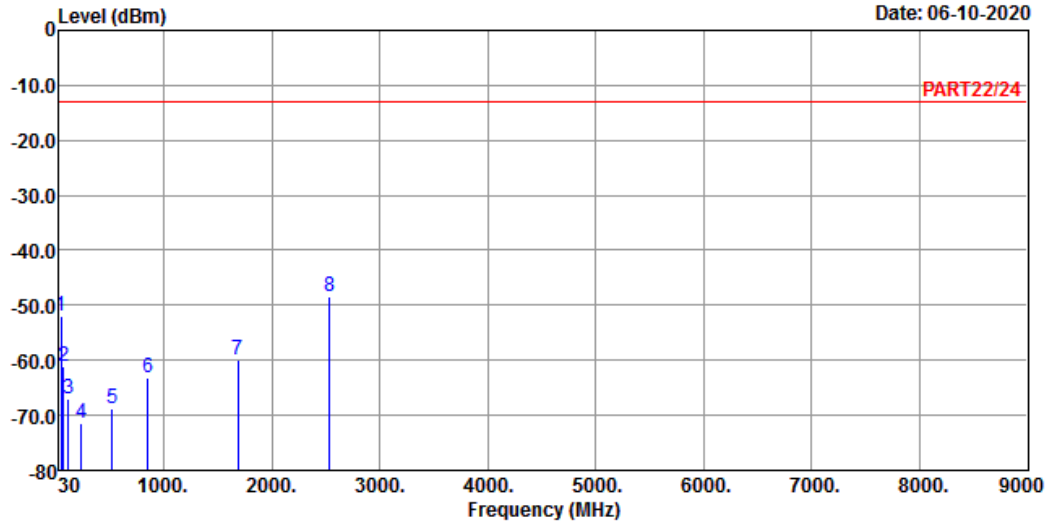

Site : 966 Chamber 5
 Condition: PART22/24 VERTICAL
 Remak : Cat-M1 Band 5 QPSK_10M Link_H-CH
 Tested by: Jisyong Wang

	Freq	Level	Read Level	Limit	Line Factor	Over Limit	Remark
	MHz	dBm	dBm	dBm	dB	dB	
1	45.12	-52.09	-49.59	-13.00	-2.50	-39.09	Peak
2	67.53	-61.11	-52.86	-13.00	-8.25	-48.11	Peak
3	112.89	-67.02	-56.82	-13.00	-10.20	-54.02	Peak
4	235.47	-71.57	-64.99	-13.00	-6.58	-58.57	Peak
5	519.10	-68.91	-64.96	-13.00	-3.95	-55.91	Peak
6	853.70	-63.29	-63.60	-13.00	0.31	-50.29	Peak
7	1688.00	-60.01	-46.02	-13.00	-13.99	-47.01	Peak
8 pp	2532.00	-48.52	-38.45	-13.00	-10.07	-35.52	Peak

LTE Band 26
 Channel Bandwidth: 1.4 MHz / QPSK
 Low Channel



Bureau Veritas Consumer Products Services Ltd., Taoyuan Branch

A D T

Data: 3

Date: 2020-06-09

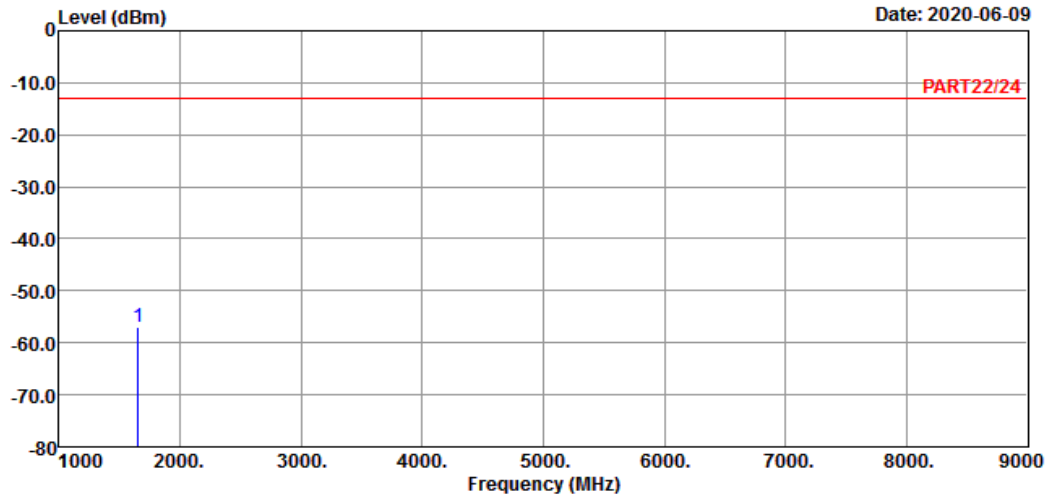

Site : 966 Chamber 5
 Condition: PART22/24 HORIZONTAL
 Remak : Cat-M1 Band 26 QPSK_1.4M Link_L-CH
 Tested by: Jisyong Wang

Freq	Level	Read Level	Limit	Line Factor	Over Limit	Remark
MHz	dBm	dBm	dBm	dB	dB	
1 pp 1649.40	-57.11	-43.37	-13.00	-13.74	-44.11	Peak



Bureau Veritas Consumer Products Services Ltd., Taoyuan Branch

A D T

Data: 4

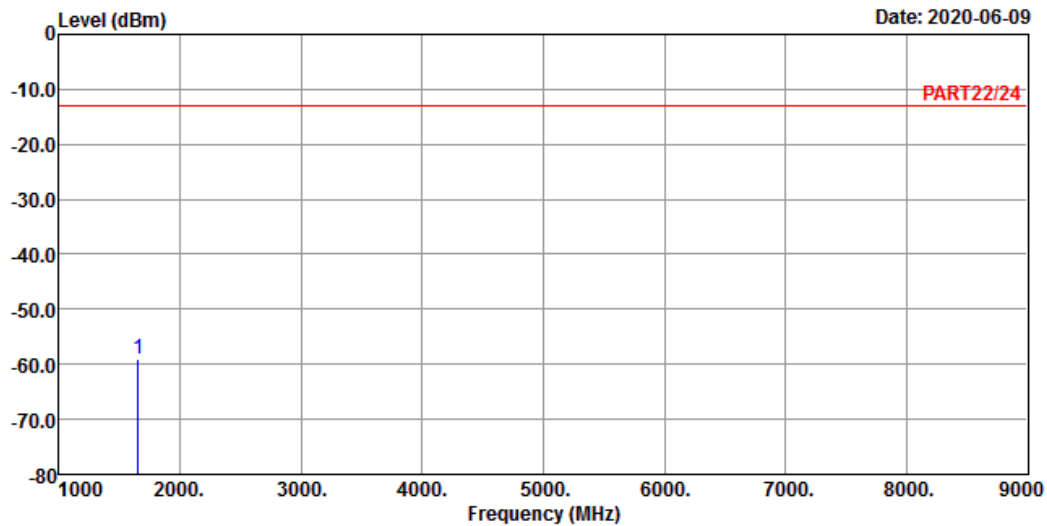

Site : 966 Chamber 5
 Condition: PART22/24 VERTICAL
 Remak : Cat-M1 Band 26 QPSK_1.4M Link_L-CH
 Tested by: Jisyong Wang

Freq	Level	Read Level	Limit	Line Factor	Over Limit	Remark
MHz	dBm	dBm	dBm	dB	dB	
1 pp 1649.40	-59.13	-45.39	-13.00	-13.74	-46.13	Peak

Middle Channel



Bureau Veritas Consumer Products Services Ltd., Taoyuan Branch

A D T

Data: 3

Date: 06-10-2020

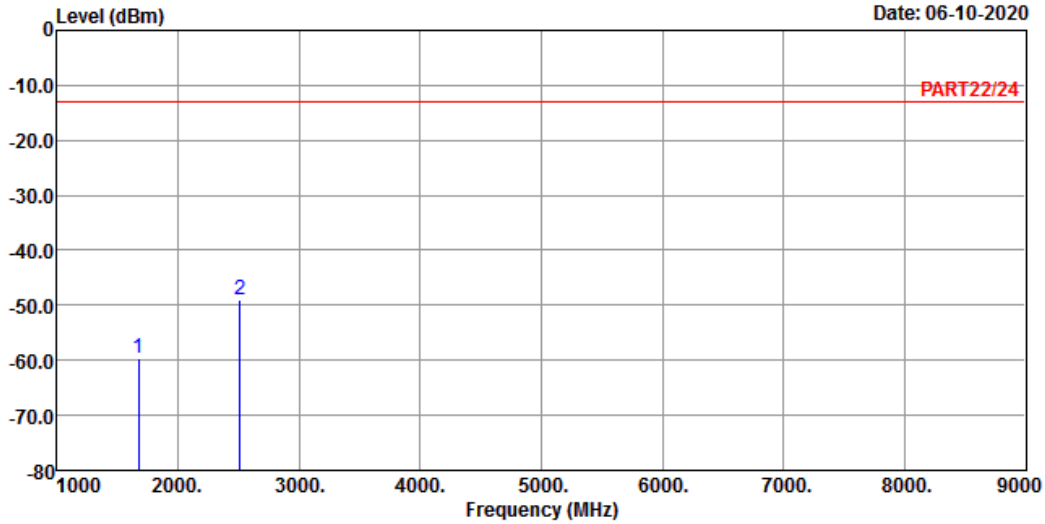

Site : 966 Chamber 5
 Condition: PART22/24 HORIZONTAL
 Remak : Cat-M1 Band 26 QPSK_1.4M Link_M-CH
 Tested by: Jisyong Wang

	Freq	Level	Read Level	Limit	Line Factor	Over Limit	Remark
	MHz	dBm	dBm	dBm	dB	dB	
1	1673.00	-59.52	-45.62	-13.00	-13.90	-46.52	Peak
2 pp	2509.50	-48.99	-38.91	-13.00	-10.08	-35.99	Peak



Bureau Veritas Consumer Products Services Ltd., Taoyuan Branch

A D T

Data: 4

Date: 06-10-2020

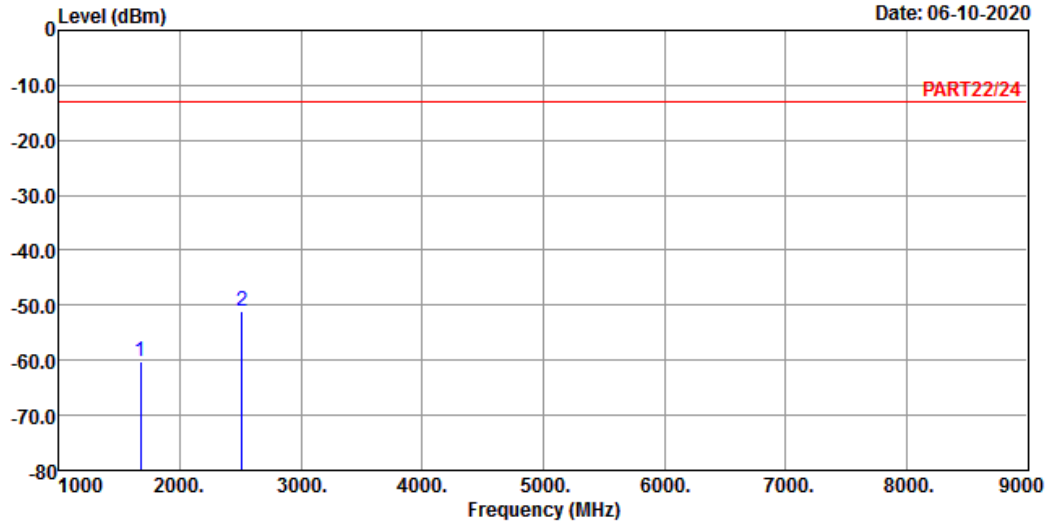

Site : 966 Chamber 5
 Condition: PART22/24 VERTICAL
 Remak : Cat-M1 Band 26 QPSK_1.4M Link_M-CH
 Tested by: Jisyong Wang

	Freq	Level	Read Level	Limit	Line Factor	Over Limit	Remark
	MHz	dBm	dBm	dBm	dB	dB	
1	1673.00	-60.25	-46.35	-13.00	-13.90	-47.25	Peak
2	pp 2509.50	-50.98	-40.90	-13.00	-10.08	-37.98	Peak

High Channel



Bureau Veritas Consumer Products Services Ltd., Taoyuan Branch

A D T

Data: 3

Date: 2020-06-09

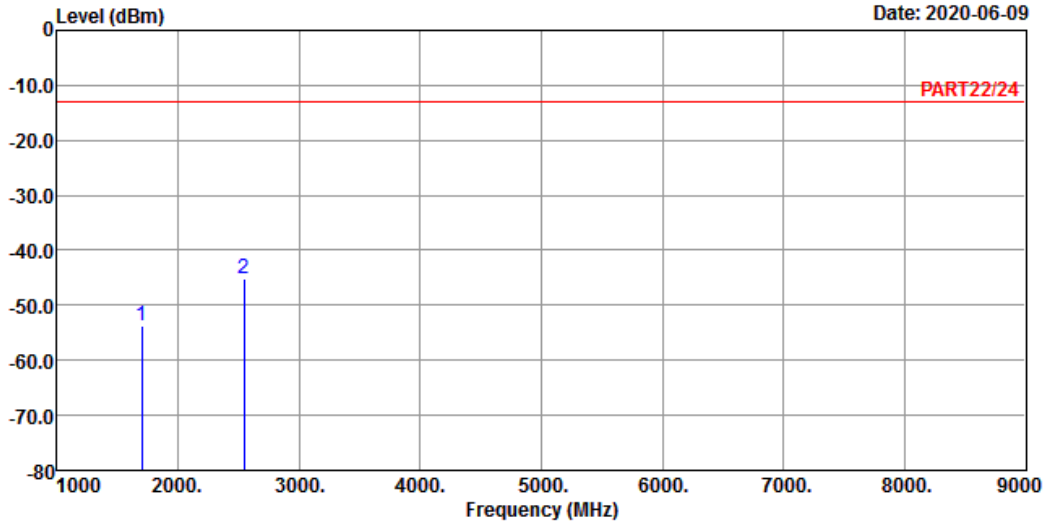

Site : 966 Chamber 5
 Condition: PART22/24 HORIZONTAL
 Remak : Cat-M1 Band 26 QPSK_1.4M Link_H-CH
 Tested by: Jisyong Wang

	Freq	Level	Read Level	Limit	Line Factor	Over Limit	Remark
	MHz	dBm	dBm	dBm	dB	dB	
1	1696.60	-53.60	-39.58	-13.00	-14.02	-40.60	Peak
2 pp	2544.90	-45.12	-35.06	-13.00	-10.06	-32.12	Peak



Bureau Veritas Consumer Products Services Ltd., Taoyuan Branch

A D T

Data: 4

Date: 06-10-2020

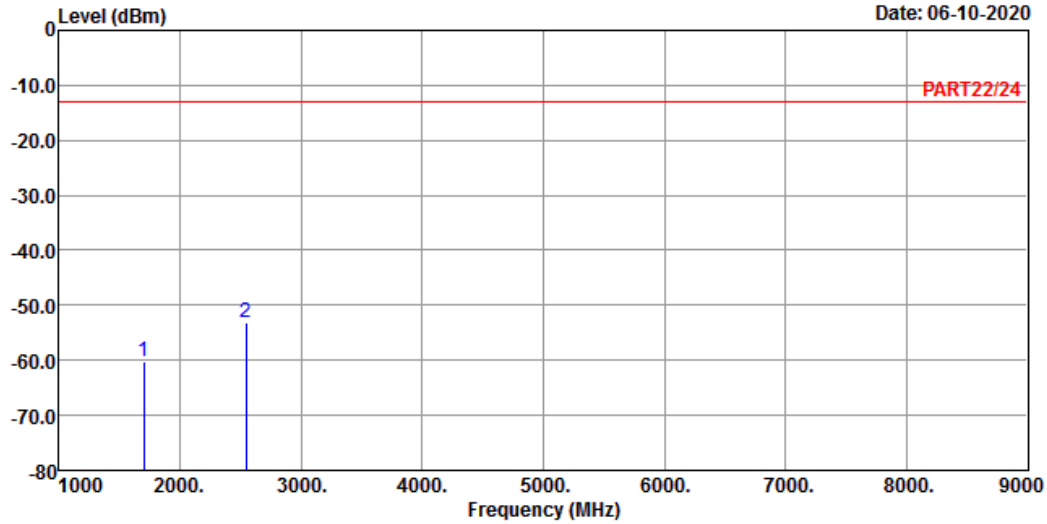

Site : 966 Chamber 5
 Condition: PART22/24 VERTICAL
 Remak : Cat-M1 Band 26 QPSK_1.4M Link_H-CH
 Tested by: Jisyong Wang

	Freq	Level	Read Level	Limit	Line Factor	Over Limit	Remark
	MHz	dBm	dBm	dBm	dB	dB	
1	1696.60	-60.23	-46.21	-13.00	-14.02	-47.23	Peak
2	pp 2544.90	-53.23	-43.17	-13.00	-10.06	-40.23	Peak

Channel Bandwidth: 5 MHz / QPSK
Low Channel



Bureau Veritas Consumer Products Services Ltd., Taoyuan Branch

A D T

Data: 3

Date: 2020-06-09

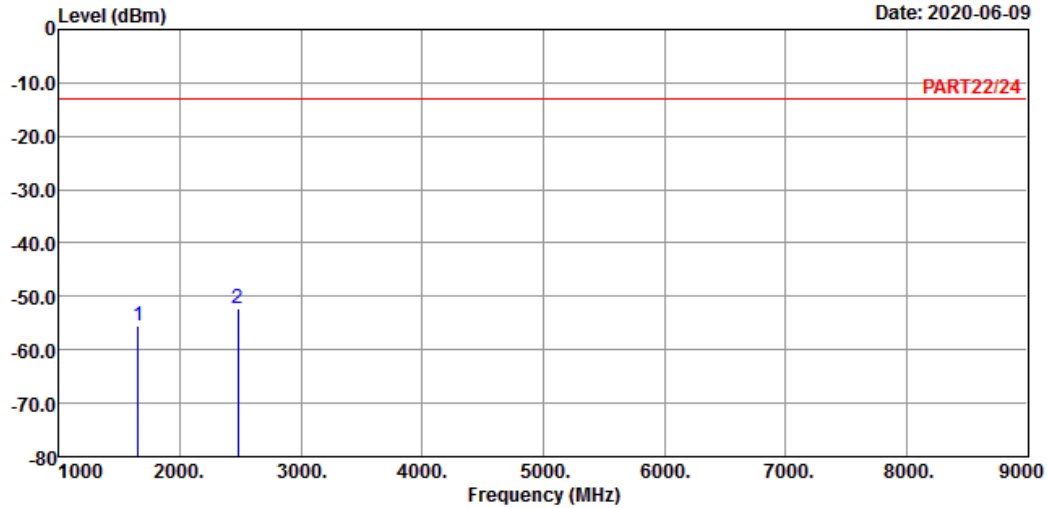

Site : 966 Chamber 5
Condition: PART22/24 HORIZONTAL
Remak : Cat-M1 Band 26 QPSK_5M Link_L-CH
Tested by: Jisyong Wang

	Freq	Level	Read Level	Limit	Line Factor	Over Limit	Remark
	MHz	dBm	dBm	dBm	dB	dB	
1	1653.00	-55.51	-41.74	-13.00	-13.77	-42.51	Peak
2 pp	2479.50	-52.19	-42.16	-13.00	-10.03	-39.19	Peak



Bureau Veritas Consumer Products Services Ltd., Taoyuan Branch

A D T

Data: 4

Date: 2020-06-09

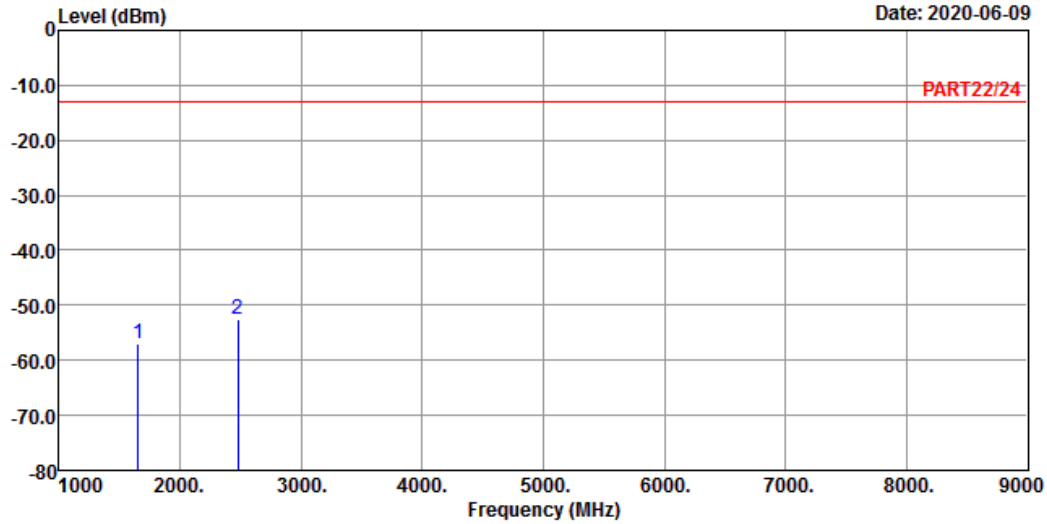

Site : 966 Chamber 5
 Condition: PART22/24 VERTICAL
 Remak : Cat-M1 Band 26 QPSK_5M Link_L-CH
 Tested by: Jisyong Wang

	Freq	Level	Read Level	Limit	Line Factor	Over Limit	Remark
	MHz	dBm	dBm	dBm	dB	dB	
1	1653.00	-56.85	-43.08	-13.00	-13.77	-43.85	Peak
2	pp 2479.50	-52.60	-42.57	-13.00	-10.03	-39.60	Peak

Middle Channel



Bureau Veritas Consumer Products Services Ltd., Taoyuan Branch

A D T

Data: 3

Date: 06-10-2020

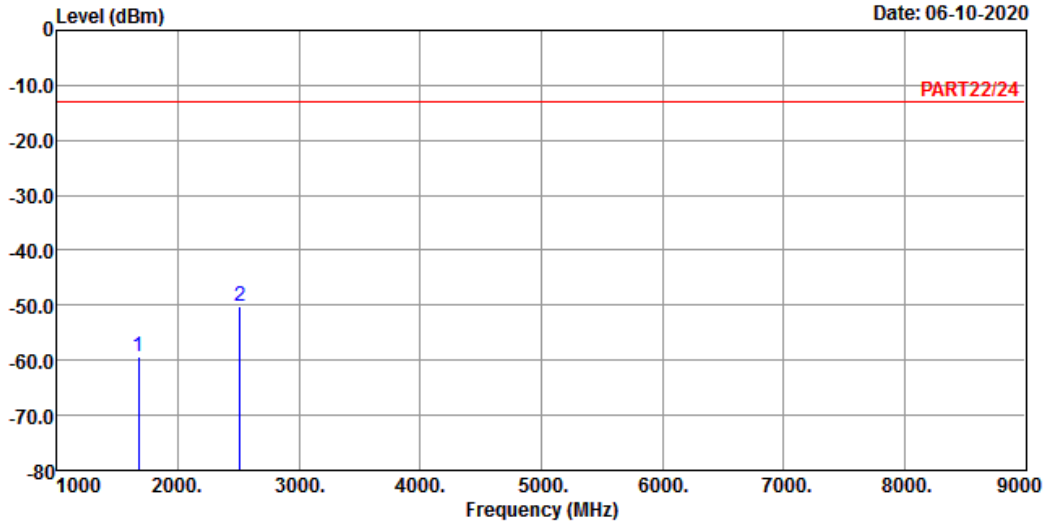

Site : 966 Chamber 5
 Condition: PART22/24 HORIZONTAL
 Remak : Cat-M1 Band 26 QPSK_5M Link_M-CH
 Tested by: Jisyong Wang

	Freq	Level	Read Level	Limit	Line Factor	Over Limit	Remark
	MHz	dBm	dBm	dBm	dB	dB	
1	1673.00	-59.23	-45.33	-13.00	-13.90	-46.23	Peak
2 pp	2509.50	-50.25	-40.17	-13.00	-10.08	-37.25	Peak



Bureau Veritas Consumer Products Services Ltd., Taoyuan Branch

A D T

Data: 4

Date: 06-10-2020

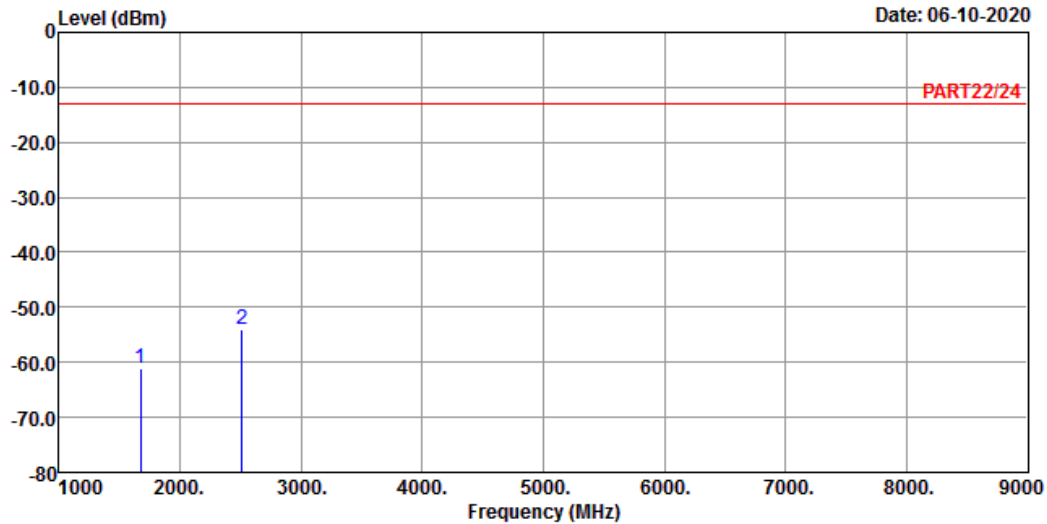

Site : 966 Chamber 5
 Condition: PART22/24 VERTICAL
 Remak : Cat-M1 Band 26 QPSK_5M Link_M-CH
 Tested by: Jisyong Wang

	Freq	Level	Read Level	Limit	Line Factor	Over Limit	Remark
	MHz	dBm	dBm	dBm	dB	dB	
1	1673.00	-61.11	-47.21	-13.00	-13.90	-48.11	Peak
2	2509.50	-54.11	-44.03	-13.00	-10.08	-41.11	Peak

High Channel



Bureau Veritas Consumer Products Services Ltd., Taoyuan Branch

A D T

Data: 3

Date: 06-10-2020

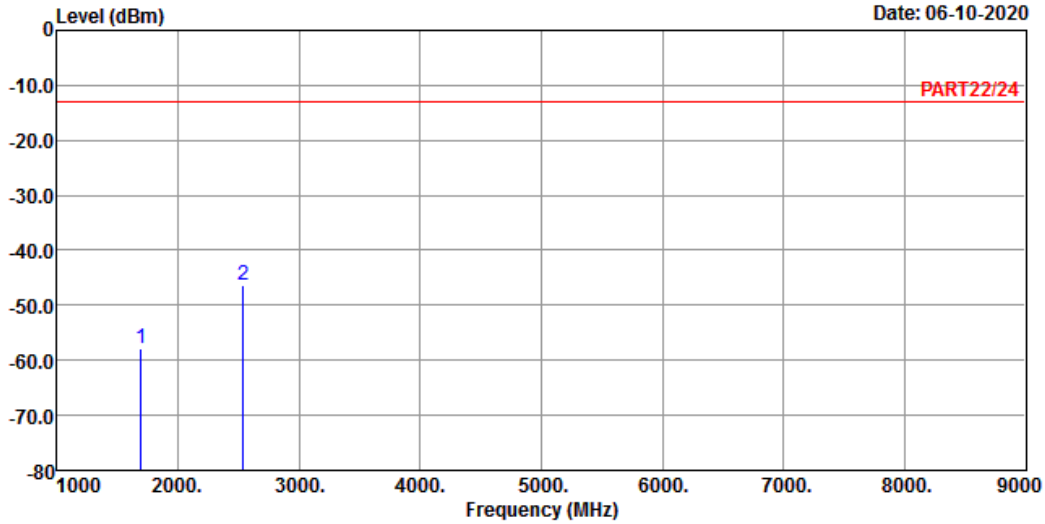

Site : 966 Chamber 5
 Condition: PART22/24 HORIZONTAL
 Remak : Cat-M1 Band 26 QPSK_5M Link_H-CH
 Tested by: Jisyong Wang

	Freq	Level	Read Level	Limit	Line Factor	Over Limit	Remark
	MHz	dBm	dBm	dBm	dB	dB	
1	1693.00	-57.99	-43.97	-13.00	-14.02	-44.99	Peak
2 pp	2539.50	-46.23	-36.17	-13.00	-10.06	-33.23	Peak



Bureau Veritas Consumer Products Services Ltd., Taoyuan Branch

A D T

Data: 4

Date: 06-10-2020

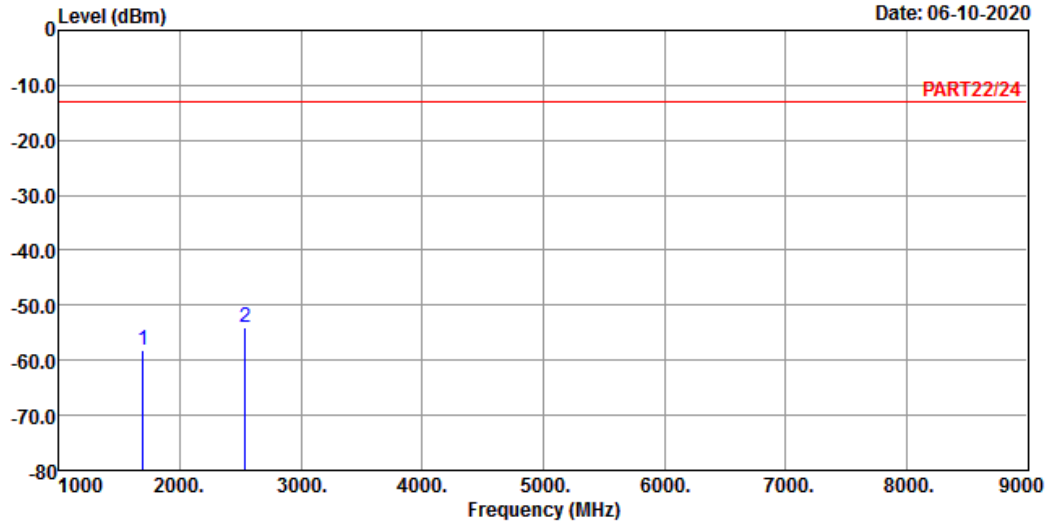

Site : 966 Chamber 5
 Condition: PART22/24 VERTICAL
 Remak : Cat-M1 Band 26 QPSK_5M Link_H-CH
 Tested by: Jisyong Wang

	Freq	Level	Read Level	Limit	Line Factor	Over Limit	Remark
	MHz	dBm	dBm	dBm	dB	dB	
1	1693.00	-58.23	-44.21	-13.00	-14.02	-45.23	Peak
2	2539.50	-54.12	-44.06	-13.00	-10.06	-41.12	Peak

Channel Bandwidth: 15 MHz / QPSK
Low Channel



Bureau Veritas Consumer Products Services Ltd., Taoyuan Branch

A D T

Data: 3

Date: 06-10-2020

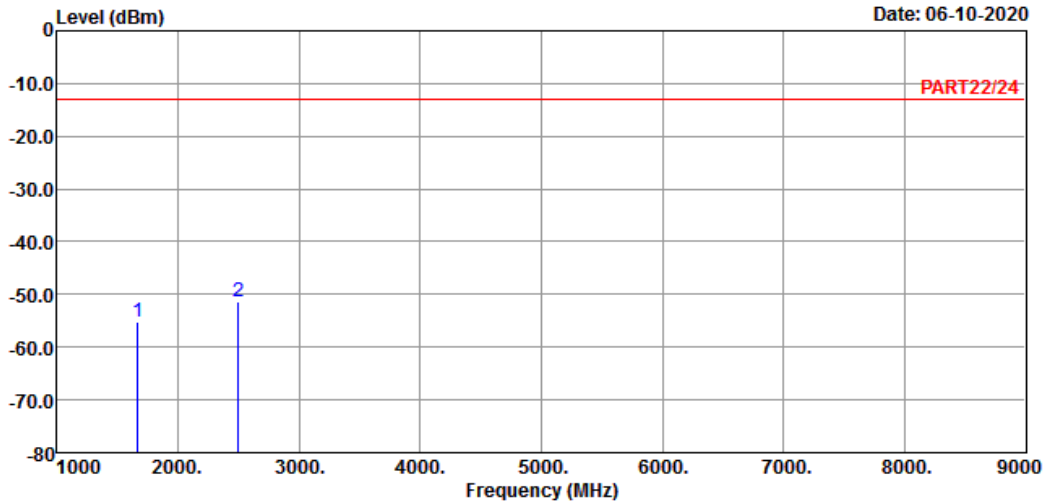

Site : 966 Chamber 5
Condition: PART22/24 HORIZONTAL
Remak : Cat-M1 Band 26 QPSK_15M Link_L-CH
Tested by: Jisyong Wang

	Freq	Level	Read Level	Limit	Line Factor	Over Limit	Remark
	MHz	dBm	dBm	dBm	dB	dB	
1	1663.00	-55.11	-41.28	-13.00	-13.83	-42.11	Peak
2	2494.50	-51.23	-41.17	-13.00	-10.06	-38.23	Peak



Bureau Veritas Consumer Products Services Ltd., Taoyuan Branch

A D T

Data: 4

Date: 06-10-2020

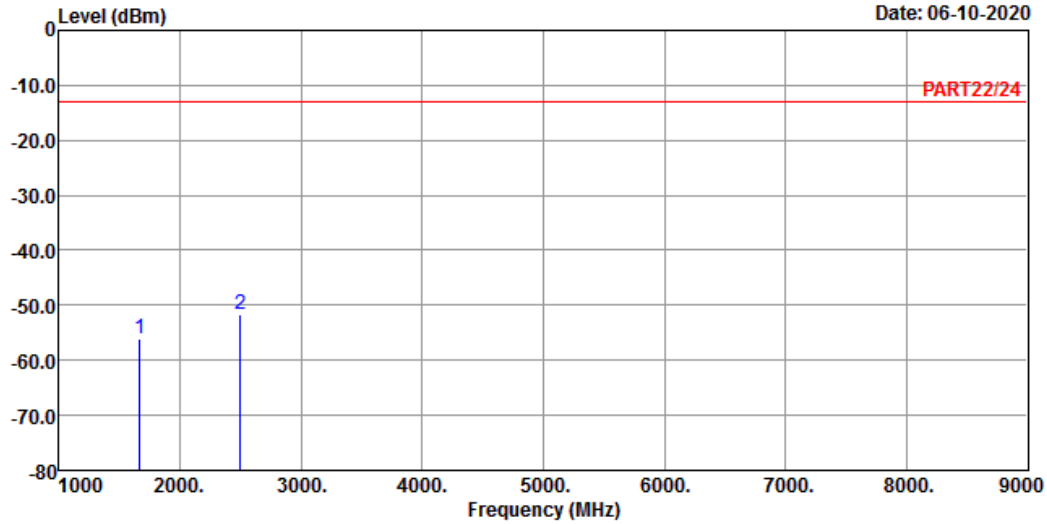

Site : 966 Chamber 5
 Condition: PART22/24 VERTICAL
 Remak : Cat-M1 Band 26 QPSK_15M Link_L-CH
 Tested by: Jisyong Wang

	Freq	Level	Read Level	Limit	Line Factor	Over Limit	Remark
	MHz	dBm	dBm	dBm	dB	dB	
1	1663.00	-56.11	-42.28	-13.00	-13.83	-43.11	Peak
2	2494.50	-51.75	-41.69	-13.00	-10.06	-38.75	Peak

Middle Channel



Bureau Veritas Consumer Products Services Ltd., Taoyuan Branch

A D T

Data: 3

Date: 06-10-2020

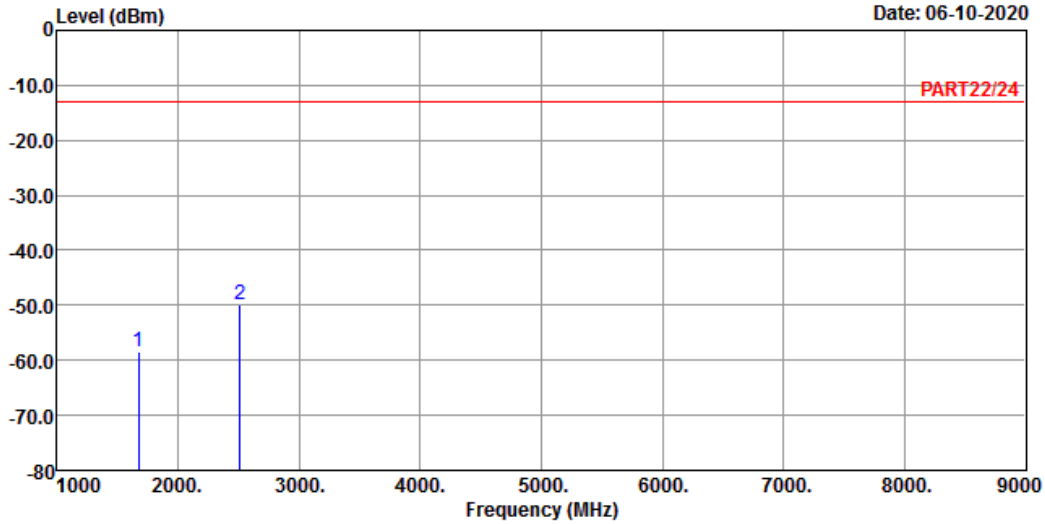

Site : 966 Chamber 5
 Condition: PART22/24 HORIZONTAL
 Remak : Cat-M1 Band 26 QPSK_15M Link_M-CH
 Tested by: Jisyong Wang

	Freq	Level	Read Level	Limit	Line Factor	Over Limit	Remark
	MHz	dBm	dBm	dBm	dB	dB	
1	1673.00	-58.56	-44.66	-13.00	-13.90	-45.56	Peak
2 pp	2509.50	-50.01	-39.93	-13.00	-10.08	-37.01	Peak



Bureau Veritas Consumer Products Services Ltd., Taoyuan Branch

A D T

Data: 4

Date: 06-10-2020

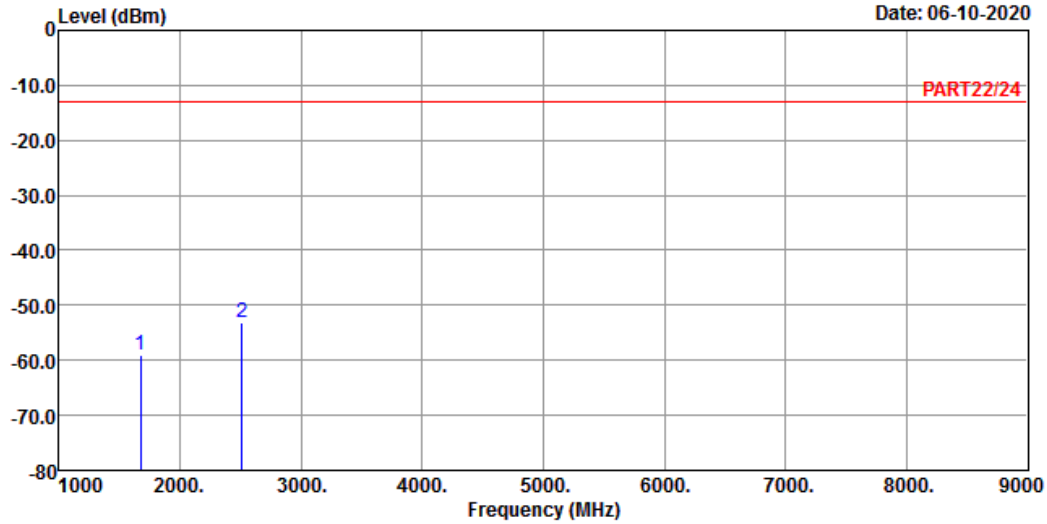

Site : 966 Chamber 5
 Condition: PART22/24 VERTICAL
 Remak : Cat-M1 Band 26 QPSK_15M Link_M-CH
 Tested by: Jisyong Wang

	Freq	Level	Read Level	Limit	Line Factor	Over Limit	Remark
	MHz	dBm	dBm	dBm	dB	dB	
1	1673.00	-59.03	-45.13	-13.00	-13.90	-46.03	Peak
2	2509.50	-53.05	-42.97	-13.00	-10.08	-40.05	Peak

High Channel



Bureau Veritas Consumer Products Services Ltd., Taoyuan Branch

A D T

Data: 7

Date: 06-10-2020

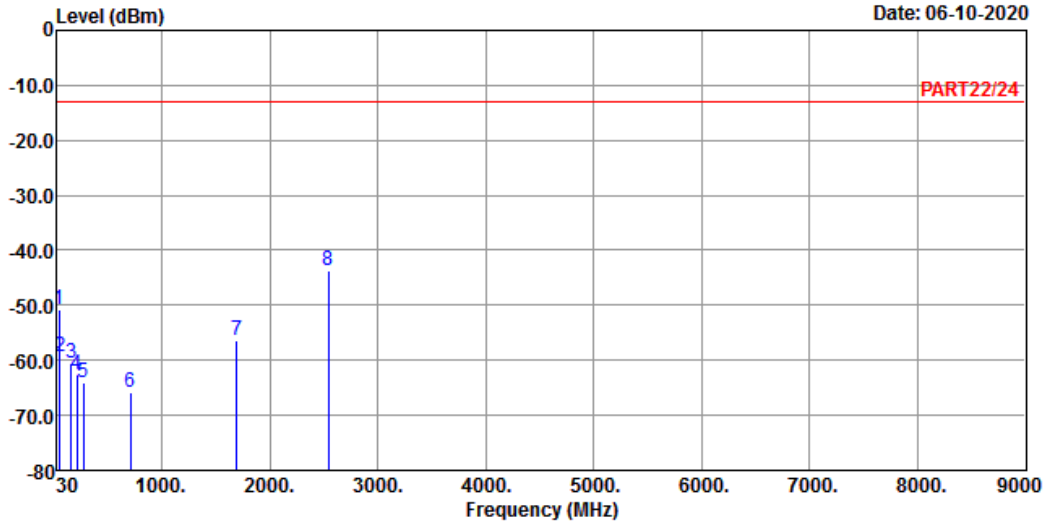

Site : 966 Chamber 5
 Condition: PART22/24 HORIZONTAL
 Remak : Cat-M1 Band 26 QPSK_5M Link_H-CH
 Tested by: Jisyong Wang

	Freq	Level	Read Level	Limit	Line	Factor	Over	Limit	Remark
	MHz	dBm	dBm	dBm		dB	dB	dB	
1	44.31	-50.85	-48.86	-13.00		-1.99	-37.85		Peak
2	54.30	-59.20	-53.13	-13.00		-6.07	-46.20		Peak
3	160.68	-60.50	-55.59	-13.00		-4.91	-47.50		Peak
4	209.28	-62.66	-55.03	-13.00		-7.63	-49.66		Peak
5	274.89	-64.03	-57.54	-13.00		-6.49	-51.03		Peak
6	712.30	-65.86	-65.99	-13.00		0.13	-52.86		Peak
7	1693.00	-56.52	-42.50	-13.00		-14.02	-43.52		Peak
8 pp	2539.50	-43.62	-33.56	-13.00		-10.06	-30.62		Peak



Bureau Veritas Consumer Products Services Ltd., Taoyuan Branch

A D T

Data: 8

Date: 06-10-2020

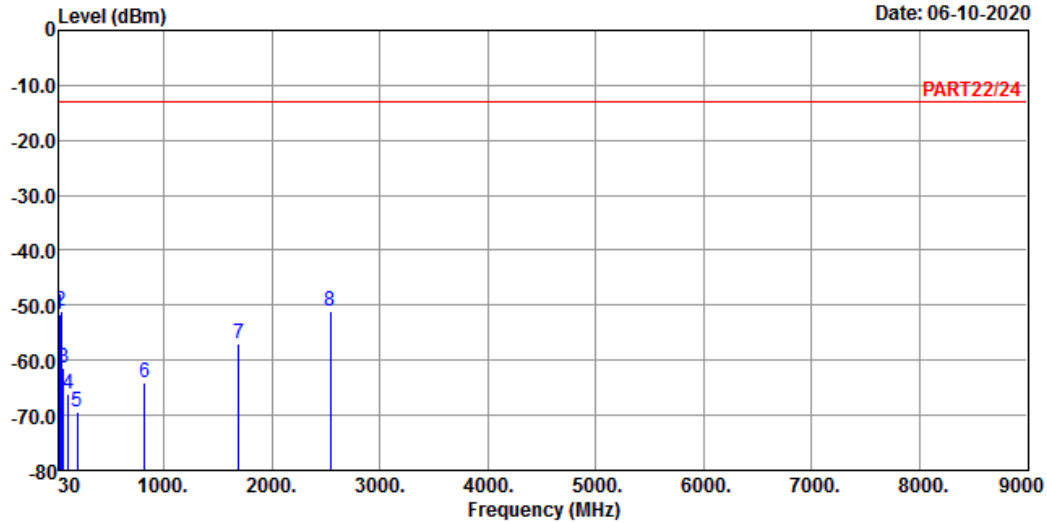

Site : 966 Chamber 5
 Condition: PART22/24 VERTICAL
 Remak : Cat-M1 Band 26 QPSK_5M Link_H-CH
 Tested by: Jisyong Wang

	Freq	Level	Read Level	Limit Line	Over Factor	Over Limit	Remark
	MHz	dBm	dBm	dBm	dB	dB	
1	30.81	-51.68	-51.57	-13.00	-0.11	-38.68	Peak
2	44.58	-50.95	-48.96	-13.00	-1.99	-37.95	Peak
3	67.26	-61.31	-53.13	-13.00	-8.18	-48.31	Peak
4	111.81	-66.04	-55.80	-13.00	-10.24	-53.04	Peak
5	193.89	-69.29	-61.83	-13.00	-7.46	-56.29	Peak
6	820.10	-64.18	-64.73	-13.00	0.55	-51.18	Peak
7	1693.00	-56.92	-42.90	-13.00	-14.02	-43.92	Peak
8	2539.50	-51.14	-41.08	-13.00	-10.06	-38.14	Peak

NB-IoT
 LTE Band 5
 Low Channel



Bureau Veritas Consumer Products Services Ltd., Taoyuan Branch

A D T

Data: 5

Date: 06-07-2020

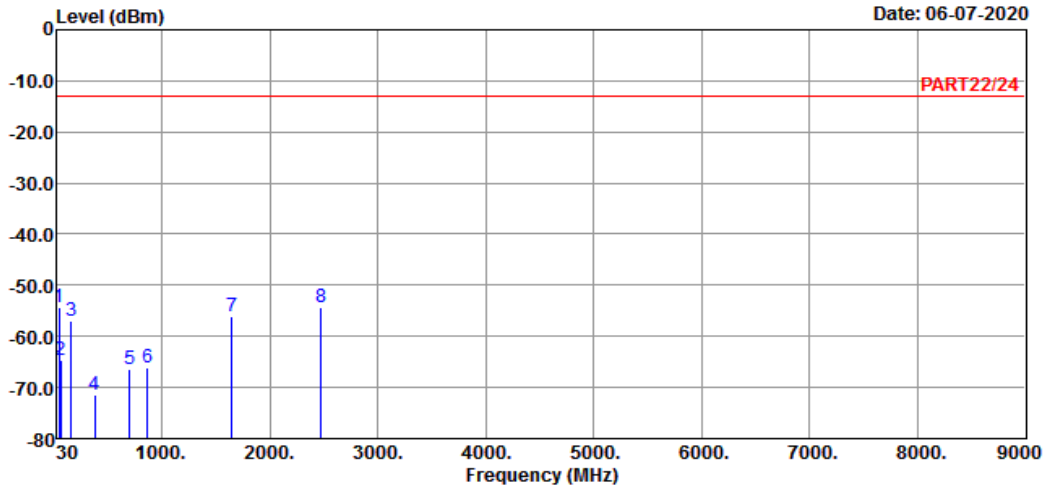

Site : 966 Chamber 5
 Condition: PART22/24 HORIZONTAL
 Remak : NB-IOT Band 5 Stand-alone_Link_L-Ch
 Tested by: Jisyong Wang

	Freq	Level	Read Level	Limit	Over	Over	Remark
	MHz	dBm	dBm	dBm	dB	dB	
1	44.55	-54.29	-52.30	-13.00	-1.99	-41.29	Peak
2	60.07	-64.58	-56.92	-13.00	-7.66	-51.58	Peak
3	160.95	-57.05	-52.14	-13.00	-4.91	-44.05	Peak
4	376.29	-71.45	-65.37	-13.00	-6.08	-58.45	Peak
5	702.21	-66.32	-66.26	-13.00	-0.06	-53.32	Peak
6	866.14	-66.24	-66.62	-13.00	0.38	-53.24	Peak
7	1648.40	-56.11	-42.37	-13.00	-13.74	-43.11	Peak
8 pp	2472.60	-54.25	-44.23	-13.00	-10.02	-41.25	Peak



Bureau Veritas Consumer Products Services Ltd., Taoyuan Branch

A D T

Data: 6

Date: 06-07-2020

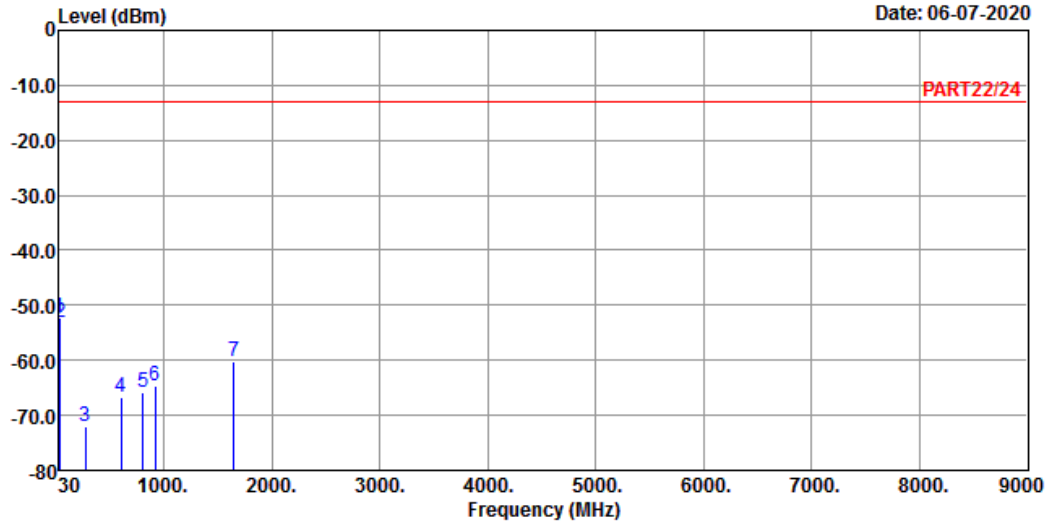

Site : 966 Chamber 5
 Condition: PART22/24 VERTICAL
 Remak : NB-IOT Band 5 Stand-alone_Link_L-Ch
 Tested by: Jisyong Wang

	Freq	Level	Read Level	Limit	Line	Factor	Over	Limit	Remark
	MHz	dBm	dBm	dBm		dB	dB		
1 pp	30.00	-52.25	-52.63	-13.00		0.38	-39.25		Peak
2	42.61	-53.28	-52.34	-13.00		-0.94	-40.28		Peak
3	269.59	-72.12	-65.73	-13.00		-6.39	-59.12		Peak
4	602.30	-66.83	-66.07	-13.00		-0.76	-53.83		Peak
5	805.03	-65.97	-66.66	-13.00		0.69	-52.97		Peak
6	920.46	-64.76	-65.84	-13.00		1.08	-51.76		Peak
7	1648.40	-60.11	-46.37	-13.00		-13.74	-47.11		Peak

Middle Channel



Bureau Veritas Consumer Products Services Ltd., Taoyuan Branch

A D T

Data: 3

Date: 06-07-2020

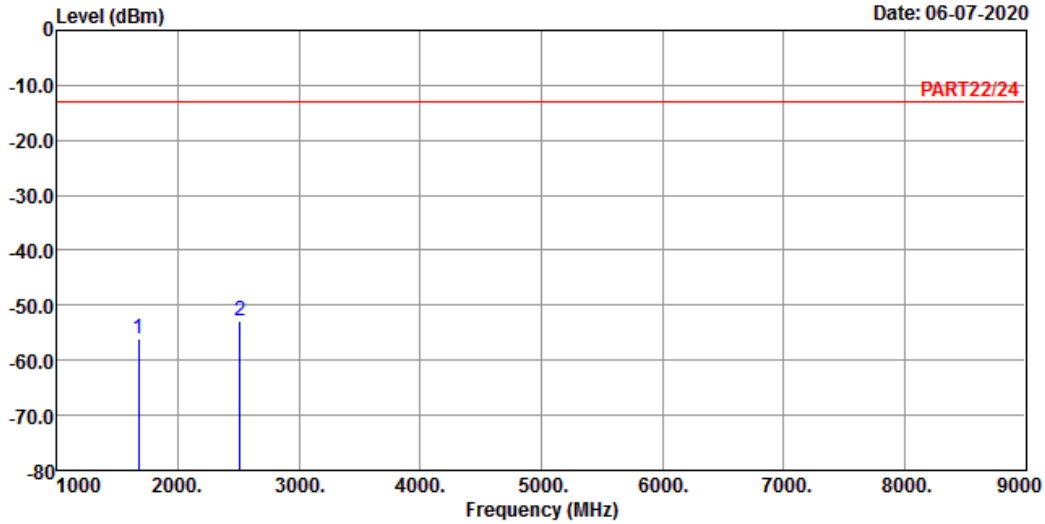

Site : 966 Chamber 5
 Condition: PART22/24 HORIZONTAL
 Remak : NB-IOT Band 5 Stand-alone_Link_M-Ch
 Tested by: Jisyong Wang

	Freq	Level	Read Level	Limit	Line Factor	Over Limit	Remark
	MHz	dBm	dBm	dBm	dB	dB	
1	1673.00	-55.99	-42.09	-13.00	-13.90	-42.99	Peak
2 pp	2509.50	-52.96	-42.88	-13.00	-10.08	-39.96	Peak



Bureau Veritas Consumer Products Services Ltd., Taoyuan Branch

A D T

Data: 4

Date: 06-07-2020

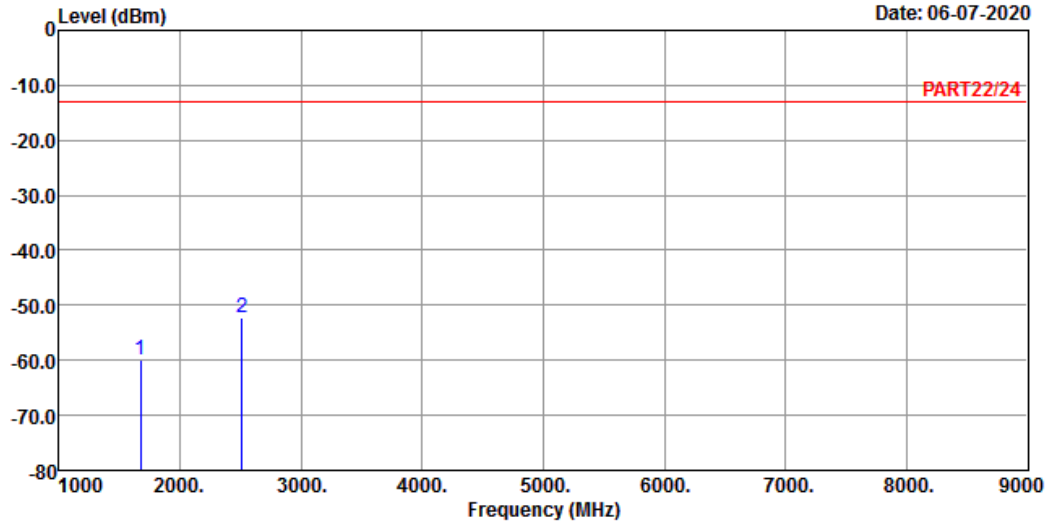

Site : 966 Chamber 5
 Condition: PART22/24 VERTICAL
 Remak : NB-IOT Band 5 Stand-alone_Link_M-Ch
 Tested by: Jisyong Wang

	Freq	Level	Read Level	Limit	Line Factor	Over Limit	Remark
	MHz	dBm	dBm	dBm	dB	dB	
1	1673.00	-59.86	-45.96	-13.00	-13.90	-46.86	Peak
2	pp 2509.50	-52.31	-42.23	-13.00	-10.08	-39.31	Peak

High Channel



Bureau Veritas Consumer Products Services Ltd., Taoyuan Branch

A D T

Data: 3

Date: 06-07-2020

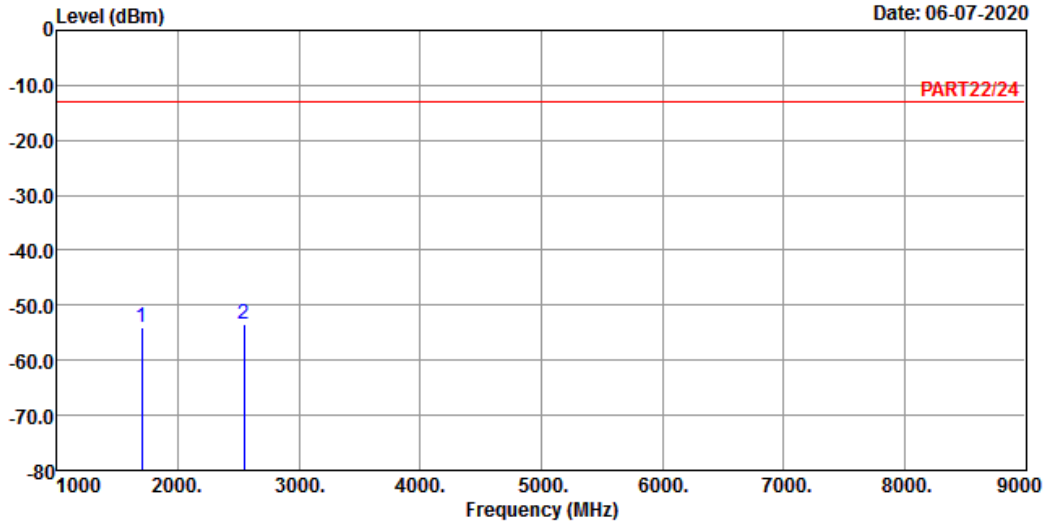

Site : 966 Chamber 5
 Condition: PART22/24 HORIZONTAL
 Remak : NB-IOT Band 5 Stand-alone_Link_H-Ch
 Tested by: Jisyong Wang

	Freq	Level	Read Level	Limit	Line Factor	Over Limit	Remark
	MHz	dBm	dBm	dBm	dB	dB	
1	1697.60	-53.99	-39.94	-13.00	-14.05	-40.99	Peak
2 pp	2546.40	-53.43	-43.37	-13.00	-10.06	-40.43	Peak



Bureau Veritas Consumer Products Services Ltd., Taoyuan Branch

A D T

Data: 4

Date: 06-07-2020

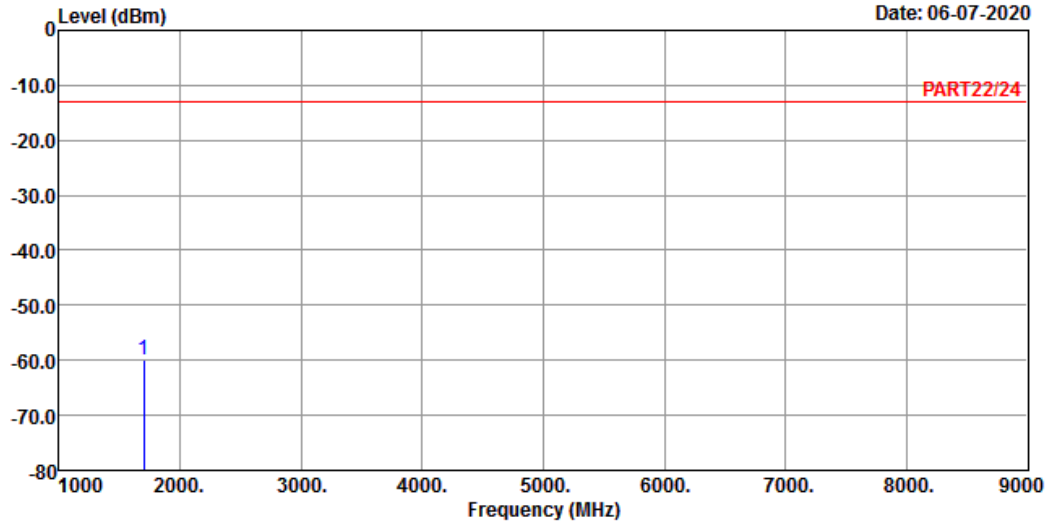

Site : 966 Chamber 5
 Condition: PART22/24 VERTICAL
 Remak : NB-IOT Band 5 Stand-alone_Link_H-Ch
 Tested by: Jisyong Wang

Freq	Level	Read Level	Limit	Line Factor	Over Limit	Remark
MHz	dBm	dBm	dBm	dB	dB	
1 pp 1697.60	-59.89	-45.84	-13.00	-14.05	-46.89	Peak

LTE Band 26
Low Channel



Bureau Veritas Consumer Products Services Ltd., Taoyuan Branch

A D T

Data: 3

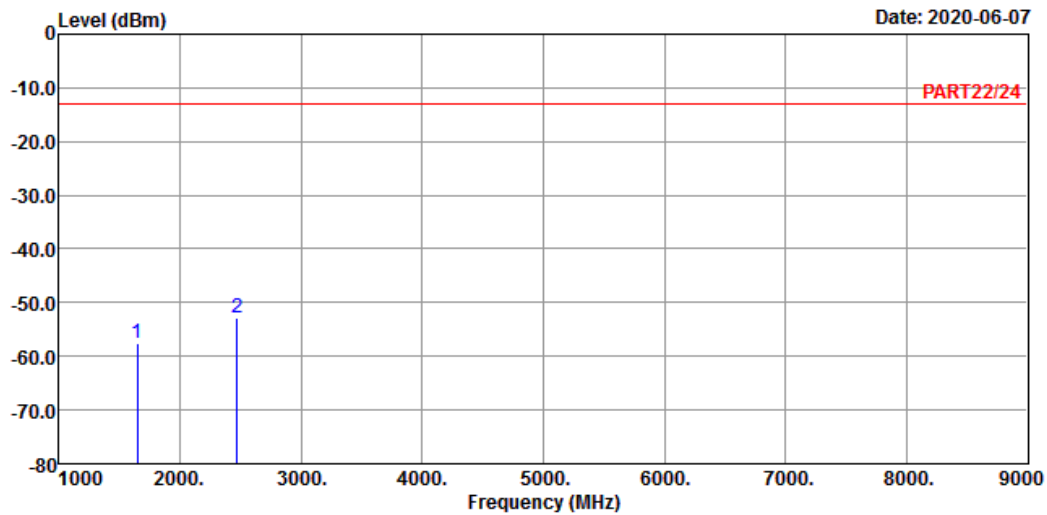

Site : 966 Chamber 5
Condition: PART22/24 HORIZONTAL
Remak : NB-IOT Band 26 Stand-alone_Link_L-Ch
Tested by: Jisyong Wang

	Freq	Level	Read Level	Limit	Line Factor	Over Limit	Remark
	MHz	dBm	dBm	dBm	dB	dB	
1	1648.40	-57.62	-43.88	-13.00	-13.74	-44.62	Peak
2	2472.60	-52.85	-42.83	-13.00	-10.02	-39.85	Peak



Bureau Veritas Consumer Products Services Ltd., Taoyuan Branch

A D T

Data: 4

Date: 2020-06-07

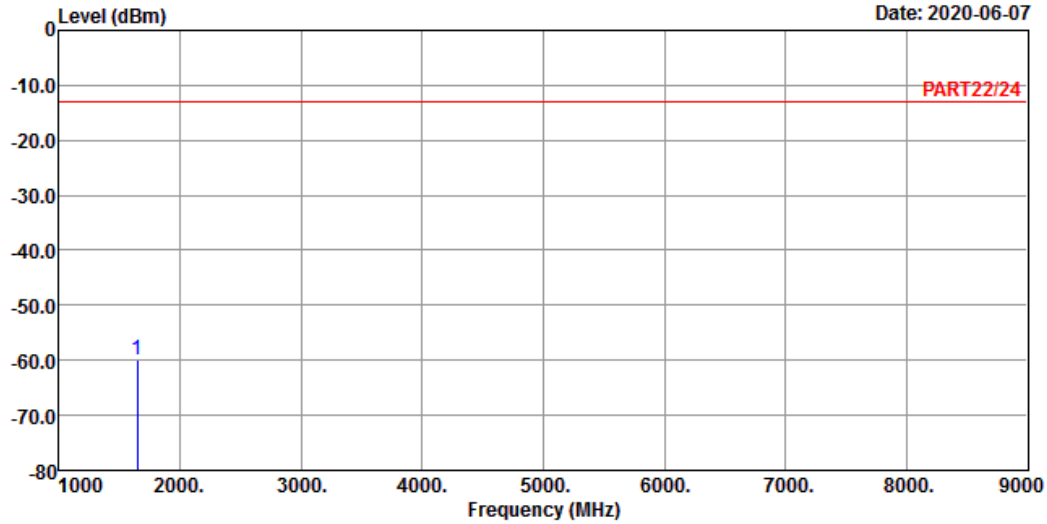

Site : 966 Chamber 5
 Condition: PART22/24 VERTICAL
 Remak : NB-IOT Band 26 Stand-alone_Link_L-Ch
 Tested by: Jisyong Wang

Freq	Level	Read Level	Limit	Line Factor	Over Limit	Remark
MHz	dBm	dBm	dBm	dB	dB	
1 pp 1648.40	-59.85	-46.11	-13.00	-13.74	-46.85	Peak

Middle Channel



Bureau Veritas Consumer Products Services Ltd., Taoyuan Branch

A D T

Data: 3

Date: 2020-06-07

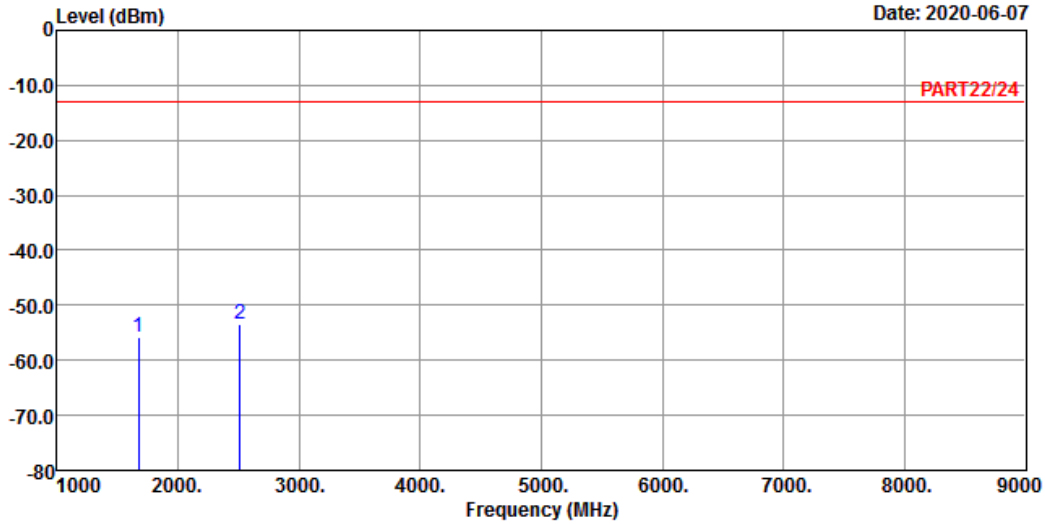

Site : 966 Chamber 5
 Condition: PART22/24 HORIZONTAL
 Remak : NB-IOT Band 26 Stand-alone_Link_M-Ch
 Tested by: Jisyong Wang

	Freq	Level	Read Level	Limit	Line Factor	Over Limit	Remark
	MHz	dBm	dBm	dBm	dB	dB	
1	1673.00	-55.89	-41.99	-13.00	-13.90	-42.89	Peak
2 pp	2509.50	-53.52	-43.44	-13.00	-10.08	-40.52	Peak



Bureau Veritas Consumer Products Services Ltd., Taoyuan Branch

A D T

Data: 4

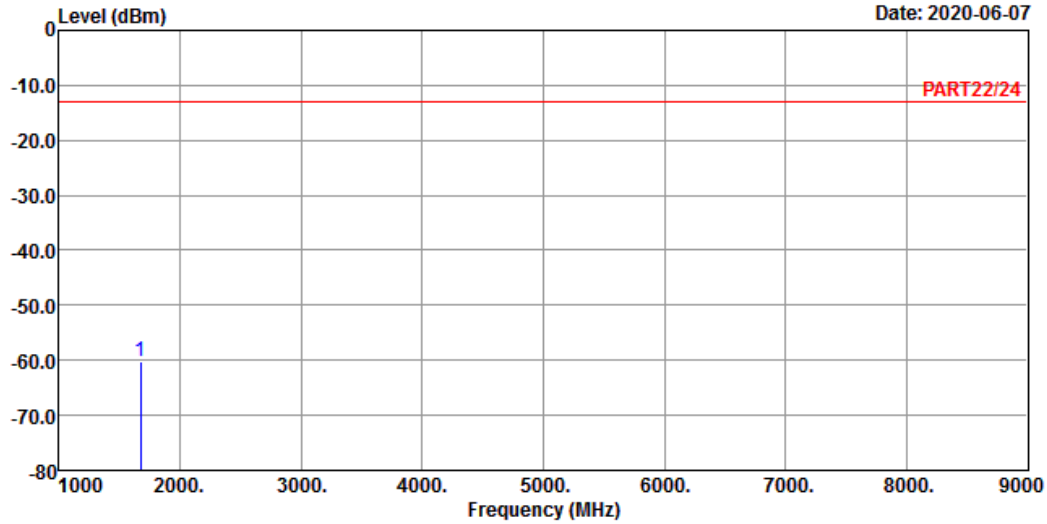

Site : 966 Chamber 5
 Condition: PART22/24 VERTICAL
 Remak : NB-IOT Band 26 Stand-alone_Link_M-Ch
 Tested by: Jisyong Wang

Freq	Level	Read Level	Limit	Line Factor	Over Limit	Remark
MHz	dBm	dBm	dBm	dB	dB	
1 pp 1673.00	-60.13	-46.23	-13.00	-13.90	-47.13	Peak

High Channel



Bureau Veritas Consumer Products Services Ltd., Taoyuan Branch

A D T

Data: 5

Date: 06-07-2020

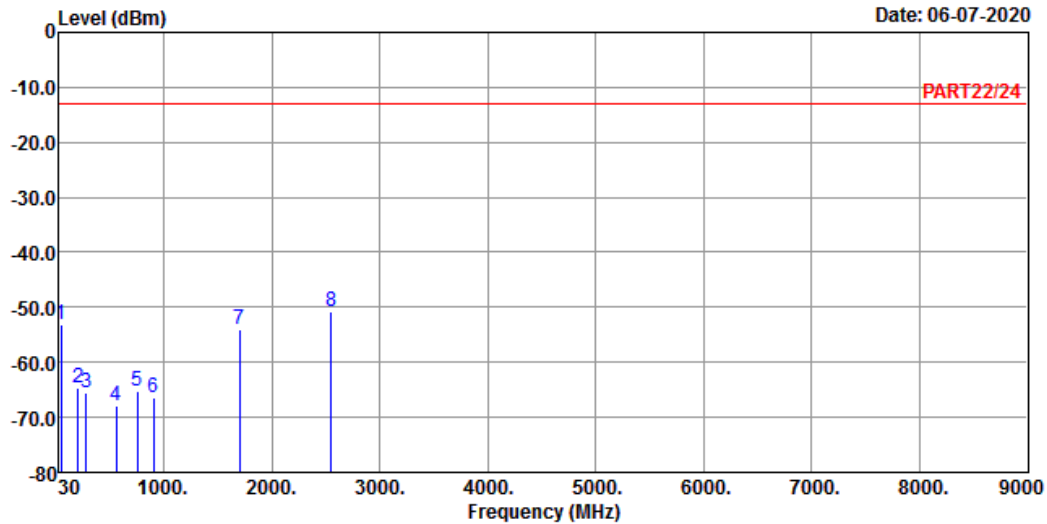

Site : 966 Chamber 5
 Condition: PART22/24 HORIZONTAL
 Remak : NB-IOT Band 26 Stand-alone_Link_H-Ch
 Tested by: Jisyong Wang

	Freq	Level	Read Level	Limit	Line	Factor	Over	Limit	Remark
	MHz	dBm	dBm	dBm		dB	dB	dB	
1	43.58	-53.20	-51.73	-13.00	-1.47	-40.20	Peak		
2	203.63	-64.53	-56.67	-13.00	-7.86	-51.53	Peak		
3	281.23	-65.68	-59.05	-13.00	-6.63	-52.68	Peak		
4	558.65	-67.98	-65.49	-13.00	-2.49	-54.98	Peak		
5	750.71	-65.30	-66.18	-13.00	0.88	-52.30	Peak		
6	901.06	-66.33	-66.93	-13.00	0.60	-53.33	Peak		
7	1697.60	-54.01	-39.96	-13.00	-14.05	-41.01	Peak		
8 pp	2546.40	-50.88	-40.82	-13.00	-10.06	-37.88	Peak		



Bureau Veritas Consumer Products Services Ltd., Taoyuan Branch

A D T

Data: 6

Date: 06-07-2020

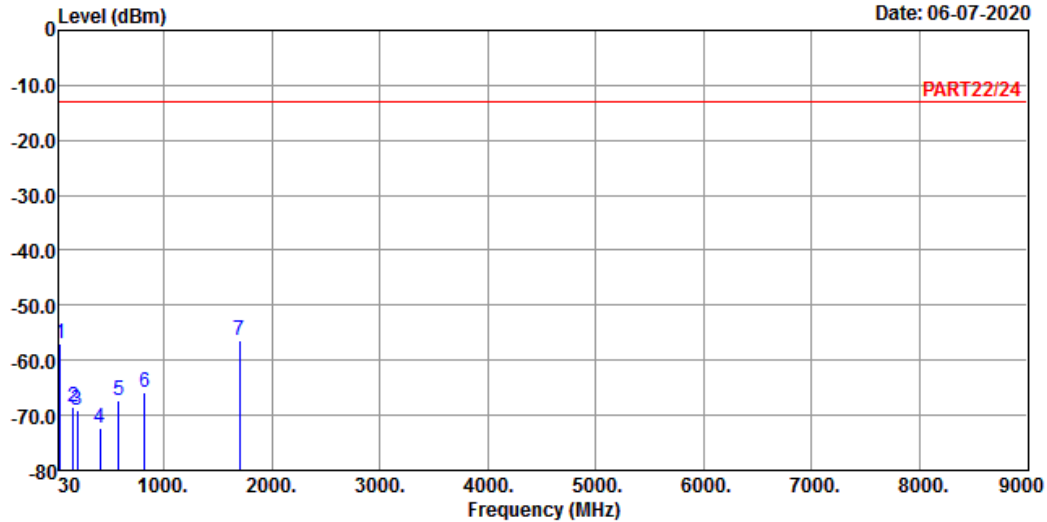

Site : 966 Chamber 5
 Condition: PART22/24 VERTICAL
 Remak : NB-IOT Band 26 Stand-alone_Link_H-Ch
 Tested by: Jisyoung Wang

	Freq	Level	Read Level	Limit	Line	Factor	Over	Limit	Remark
	MHz	dBm	dBm	dBm		dB	dB		
1	40.67	-56.93	-57.05	-13.00		0.12	-43.93		Peak
2	159.98	-68.47	-63.63	-13.00		-4.84	-55.47		Peak
3	195.87	-69.06	-61.41	-13.00		-7.65	-56.06		Peak
4	407.33	-72.35	-66.46	-13.00		-5.89	-59.35		Peak
5	582.90	-67.44	-65.96	-13.00		-1.48	-54.44		Peak
6	824.43	-65.77	-66.29	-13.00		0.52	-52.77		Peak
7 pp	1697.60	-56.51	-42.46	-13.00		-14.05	-43.51		Peak

5 Pictures of Test Arrangements

Please refer to the attached file (Test Setup Photo).

Appendix – Information of the Testing Laboratories

We, Bureau Veritas Consumer Products Services (H.K.) Ltd., Taoyuan Branch, were founded in 1988 to provide our best service in EMC, Radio, Telecom and Safety consultation. Our laboratories are FCC recognized accredited test firms and accredited according to ISO/IEC 17025.

If you have any comments, please feel free to contact us at the following:

Lin Kou EMC/RF Lab

Tel: 886-2-26052180

Fax: 886-2-26051924

Hsin Chu EMC/RF/Telecom Lab

Tel: 886-3-6668565

Fax: 886-3-6668323

Hwa Ya EMC/RF/Safety Lab

Tel: 886-3-3183232

Fax: 886-3-3270892

Email: service.adt@tw.bureauveritas.com

Web Site: www.bureauveritas-adt.com

The address and road map of all our labs can be found in our web site also.

--- END ---