



EMC Test Report

Product Name: Smart Phone

Model Number: DUB-LX1

Report No: SYHB(Z-EMC) 20181011030002-2

FCC ID: QISDUB-LX1

Reliability Laboratory of Huawei Technologies Co., Ltd.

(Global Compliance and Testing Center of Huawei Technologies Co., Ltd)

No.2 New City Avenue Songshan Lake Sci. &Tech. Industry Park, Dongguan, Guangdong, 523808,
P.R.C

Tel: +86 755 28780808 Fax: +86 755 89652518

Notice

1. The laboratory has passed the accreditation by China National Accreditation Service for Conformity Assessment (CNAS). The accreditation number is L0310 for site 1.
2. The laboratory has passed the accreditation by The American Association for Laboratory Accreditation (A2LA). The accreditation number is 2174.01 for site 1.
3. The laboratory has been listed by Industry Canada to perform electromagnetic emission measurements. The recognition numbers of test site are 6369A-1 for site 1.
4. The laboratory has been recognized by the US Federal Communications Commission (FCC) to perform compliance testing subject to the Commission's Declaration Of Conformity (DOC) and Certification rules. The Designation Number is CN1173, and the Test Firm Registration Number is 294140 for site 1.
5. The laboratory has been recognized by the US Federal Communications Commission (FCC) to perform compliance testing subject to the Commission's Declaration Of Conformity (DOC) and Certification rules. The Designation Number is CN5019, and the Test Firm Registration Number is 577730 for site 2.
6. The laboratory has passed the accreditation by The American Association for Laboratory Accreditation (NVLAP). The accreditation number is 4086F-1 for site 2.
7. The laboratory (Reliability Lab of Huawei Technologies Co., Ltd) is also named as “Global Compliance and Testing Center of Huawei Technologies Co., Ltd”, the both names have coexisted since 2009.
8. The test report is invalid if not marked with the stamps or the signatures of the persons responsible for performing, revising and approving the test report.
9. The test report is invalid if there is any evidence of erasure and/or falsification.
10. If there is any dissidence for the test report, please file objection to the test centre within 15 days from the date of receiving the test report.
11. Normally, the test report is only responsible for the samples that have undergone the test.
12. Context of the test report cannot be used partially or in full for publicity and/or promotional purposes without previous written approval of the laboratory.



Applicant: Huawei Technologies Co., Ltd.
Address: Administration Building, Headquarters of Huawei Technologies Co., Ltd., Bantian, Longgang District, Shenzhen, 518129, P.R.C

Date of Receipt Test Item: 2018-10-25
Start Date of Test: 2018-10-30
End Date of Test: 2018-11-22

Test Result: Pass

**Approved By
(Lab Manager)**

2018-11-23
Date

He Hao
Name

He Hao
Signature

**Prepared by
(Test Engineer)**

2018-11-22
Date

Chang Lina
Name

Chang Lina
Signature



Modification Record



No.	Last Report No.	Modification Description
1	NA	First Report.









TABLE OF CONTENT

1	General Information.....	6
1.1	EUT Description	6
1.2	Test Site Information.....	9
1.3	Applied Standards.....	9
2	Summary of Results	10
3	System Configuration during EMC Test	11
3.1	Test Mode	11
3.2	Test System Configuration	12
3.3	Cables Used during Test.....	14
3.4	Associated Equipment Used during Test	14
4	Electromagnetic Interference (EMI)	15
4.1	Radiated Disturbance 30MHz to 26.5GHz.....	15
4.2	Conducted Disturbance 0.15 MHz to 30MHz.....	17
5	Main Test Instruments	18
6	System Measurement Uncertainty	18
7	Test Data and Graph.....	19
7.1	Radiated Disturbance.....	19
7.2	Conducted Disturbance.....	22

1 General Information

1.1 EUT Description

EUT Description	
Product Name	Smart Phone
Model Number	DUB-LX1
Input voltage	3.82V
TX Frequency	GSM 850: 824MHz to 849MHz PCS 1900: 1850MHz to 1910MHz WCDMA Band II: 1850MHz to 1910MHz WCDMA Band V: 824MHz to 949MHz LTE BAND 5: 824MHz to 849MHz LTE BAND 7: 2500MHz to 2570MHz Bluetooth: 2400MHz to 2483.5MHz 2.4G WIFI: 2412MHz to 2462MHz
RX Frequency	GSM 850: 869MHz to 894MHz PCS 1900: 1930MHz to 1990MHz WCDMA Band II: 1930MHz to 1990MHz WCDMA Band V: 869MHz to 894MHz LTE BAND 5: 869MHz to 894MHz LTE BAND 7: 2620MHz to 2690MHz Bluetooth: 2400MHz to 2483.5MHz 2.4G WIFI: 2412MHz to 2462MHz GPS: 1575.42MHz BDS: 1561.098MHz GLONASS: 1597MHz -1607MHz FM: 87.5MHz to 108MHz
S/N	4FF0118A13000046
HW Version	HL3DUBM
SW Version	DUB-LX1 8.2.0.107(C900)
EUT Accessory	
USB Cable	Data Cable USB A Male to Micro Usb,100cm,Shielded Manufacturer: HONGLIN TECHNOLOGY CO., LTD. Ningbo Broad Telecommunication Co., Ltd LUXSHARE Precision Industry Co., Ltd FOXCONN INTERCONNECT TECHNOLOGY LIMITED
Adapter	Manufacturer:Huawei Technologies Co.,Ltd. Model: HW-050200E02 Input voltage: 100-240V 50/60Hz ,0.5A Output voltage: 5V  2A Rated Power: 10W SN: B95432J5T00024;K95401J3V00084; H9541RJ4L00140;
Adapter	Manufacturer:Huawei Technologies Co.,Ltd. Model: HW-050200A02 Input voltage: 100-240V 50/60Hz ,0.5A Output voltage: 5V  2A

	Rated Power: 10W SN: B95632J3B00021; K95601HAA00036;
Adapter	Manufacturer:Huawei Technologies Co.,Ltd. Model: HW-050200B02 Input voltage: 100-240V 50/60Hz ,0.5A Output voltage: 5V  2A Rated Power: 10W SN: H95316J4200029;B95332J3Y00059; K95301J3X00032;
Adapter	Manufacturer:Huawei Technologies Co.,Ltd. Model: HW-050200U02 Input voltage: 100-240V 50/60Hz ,0.5A Output voltage: 5V  2A Rated Power: 10W SN: B95532J5T00018;H955KAJ4M00153; K95501J3N00026;
Adapter	Manufacturer:Huawei Technologies Co.,Ltd. Model: HW-050200E01 Input voltage: 100-240V 50/60Hz ,0.5A Output voltage: 5V  2A Rated Power: 10W SN: B78714H7H00861;H787K8J5K00952; P78714J5255628;
Adapter	Manufacturer:Huawei Technologies Co.,Ltd. Model: HW-050200U01 Input voltage: 100-240V 50/60Hz 0.5A Output Voltage: 5V  5A Rated Power:10W SN: H786K9J4V01394;B78697J4J03533; P78621J4278130;
Adapter	Manufacturer:Huawei Technologies Co.,Ltd. Model: HW-050200A01 Input voltage: 100-240V 50/60Hz ,0.5A Output voltage: 5V  2A Rated Power: 10W SN: P78911H6A04740; B78975GCD22322; H789K7HA502790
Adapter	Manufacturer:Huawei Technologies Co.,Ltd. Model: HW-050200B01 Input voltage: 100-240V 50/60Hz ,0.5A Output voltage: 5V  2A Rated Power: 10W SN:H788K7H4N00955;P78817H7D35407; B78830H7H01619
Li-Polymer Battery	Manufacturer:Huawei Technologies Co.,Ltd. Battery Model: HB406689ECW Rated capacity: 3900mAh Nominal Voltage:  +3.82V Charging Voltage:  +4.40V SN: 2692SCI4239DDEFF; 5UUJAYI707X0052F
Earphone(22040322)	Manufacturer:



	Jiangxi Lianchuang Hongsheng Electronic Co. ,LTD Boluo County Quancheng Electronic Co.,ltd
Earphone(22040150)	Manufacturer: Jiangxi Lianchuang Hongsheng Electronic Co. ,LTD Boluo County Quancheng Electronic Co.,ltd

Remark: The above EUT's information is declared by manufacturer. Please refer to the specifications or user's manual for more detailed information.

1.2 Test Site Information

Site 1:	RELIABILITY LABORATORY OF HUAWEI TECHNOLOGIES CO., LTD.
Test Site Location:	No.2 New City Avenue Songshan Lake Sci. &Tech. Industry Park, Dongguan, Guangdong, P.R.C
Site 2:	Sporton International (Shenzhen) Inc.
Test Site Location:	No.3 Building, the third floor of south, Shahe River west, Fengzeyuan warehouse, Nanshan District, Shenzhen, Guangdong, P.R.China

1.3 Applied Standards

APPLIED STANDARD

47 CFR FCC Part 15, Subpart B

2 Summary of Results

Summary of Results				
Test Items	Test Mode	Performance Class & Required Performance Criteria	Result	Site
<u>Radiated Emissions</u> Enclosure Port	Mode 2~ Mode 5	CLASS B	Pass	Site2
<u>Conducted Emissions</u> <input type="checkbox"/> DC Power Port <input checked="" type="checkbox"/> AC Power Port <input type="checkbox"/> Telecommunication Ports	Mode 1~ Mode 5	CLASS B	Pass	Site1
Note: 1, Measurement taken is within the uncertainty of test system. 2, <input checked="" type="checkbox"/> The item has been tested; <input type="checkbox"/> The item has not been tested.				

During the measurement, the environmental conditions complied with the range listed as below.

Item	Required
Ambient temperature	15°C ~ 35°C
Relative humidity	25% ~ 75%
Atmospheric pressure	86kPa ~ 106kPa

3 System Configuration during EMC Test

3.1 Test Mode

The EUT was configured, installed, arranged and operated in a manner consistent with typical application. The following mode(s) were applied during the compliance test.

Test Mode	
Mode 1:	Charging +traffic +WIFI+BT+GNSS On +Earphone
Mode 2:	Charging +Camera On +Earphone +idle
Mode 3:	Charging +Video Playing +Earphone +idle
Mode 4:	Charging +FM +Earphone +idle
Mode 5:	USB Copy(EUT with PC) +Earphone

Remark:

- 1) If there is one kind of accessories with different models, each one should be applied throughout the compliance test respectively, however, only the worst case will be recorded in this report.
- 2) If EUT has more than one typical operation, only the worst test mode will be recorded in this report.

Traffic Mode:

When the EUT state is switched on and with Radio Resource Control (RRC) connection established.

Idle Mode:

When the EUT state is switched on but without Radio Resource Control (RRC) connection.

Worst Case:

- 1) Radiated Emission
Adapter (Model: HW-050200U02, SN: B95532J5T00018) + Charging + Video Playing +Earphone +idle the result is the worst (30MHz~1GHz).
Adapter (Model: HW-050200U02, SN: B95532J5T00018) + Charging + Video Playing +Earphone +idle the result is the worst (1GHz~18GHz).
Adapter (Model: HW-050200E01, SN: P78714J5255628) + Charging + Video Playing +Earphone +idle the result is the worst (18GHz~26.5GHz).
- 2) Conducted Emission
Adapter (Model: HW-050200B01, SN: B78830H7H01619) + Charging +Video Playing +Earphone +idle the result is the worst.

3.2 Test System Configuration

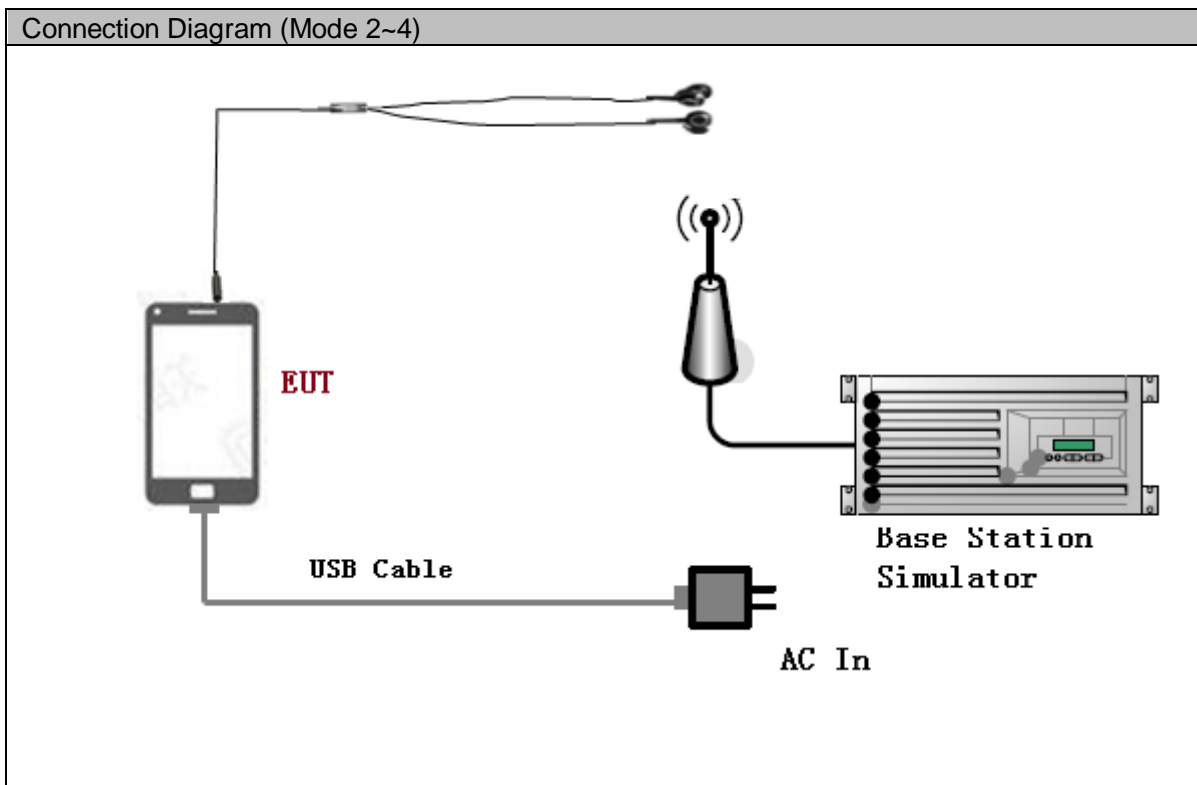
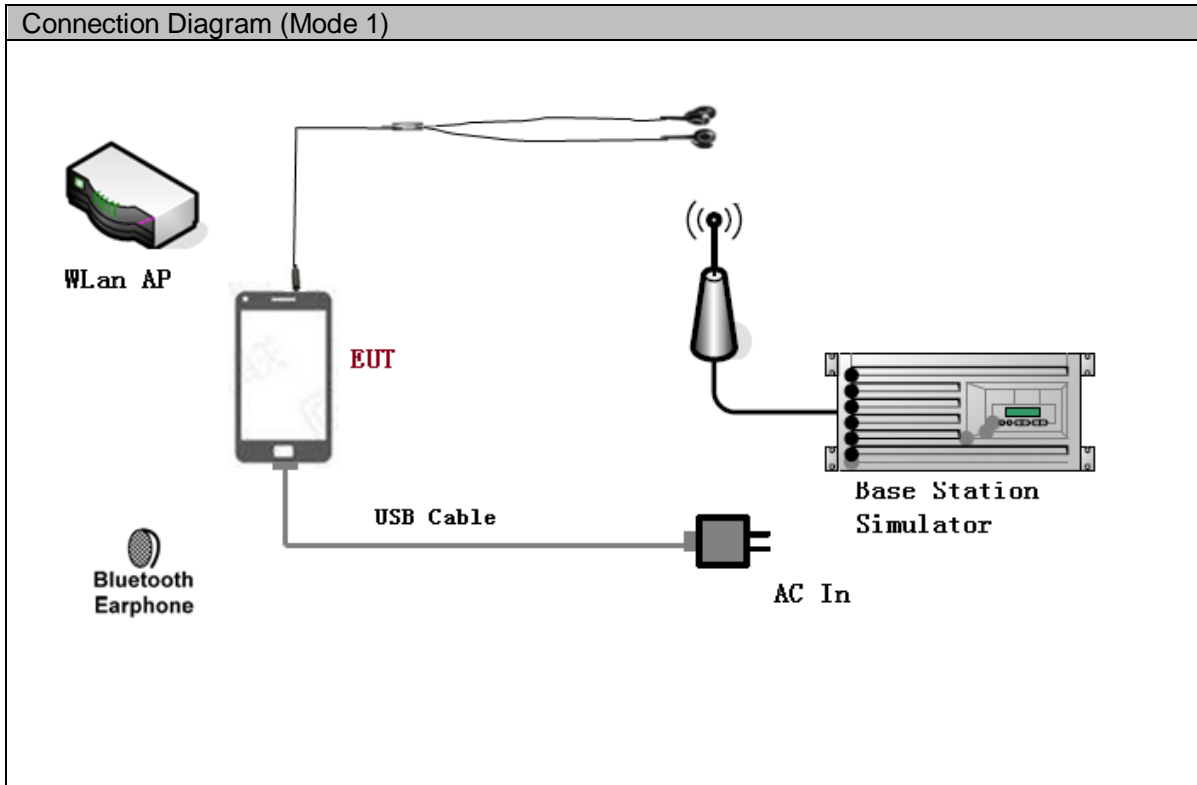

Connection Diagram (Mode 5)

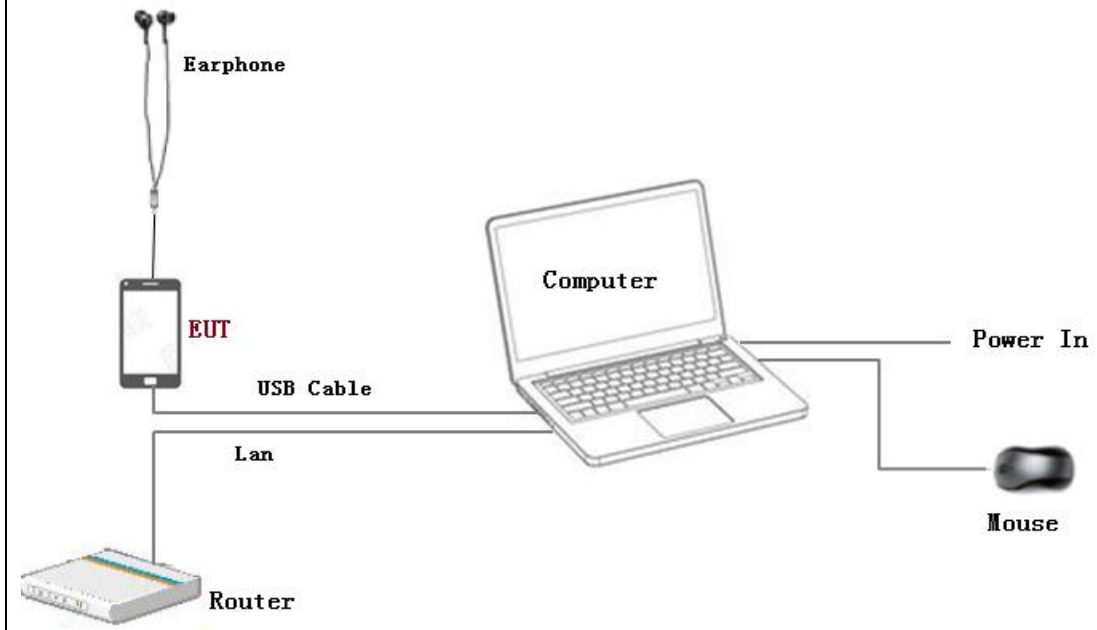

3.3 Cables Used during Test

Cable	Quantity	Length	Type of Cable
USB	1	<3m	Shielded
Earphone	1	<3m	Unshielded

3.4 Associated Equipment Used during Test

Name	Model	Manufacturer	S/N	Calibrated Deadline	Cal interval (month)
Radio Communication Tester	CMU200	R&S	3608082535	2019-03-14	12
Radio Communication Tester	MT8820C	Anritsu	A110518805	2019-05-07	12
Base Station	CMW500	R&S	150791	2019-07-17	12
Notebook	S3	ThinkPad	A140714638	/	/
Notebook	171501-AQ	ThinkPad	S180905FGE06	/	/
Mouse	MOHQUO	HP	GIK28AA	/	/
Mouse	N231	Logitech	/	/	/

4 Electromagnetic Interference (EMI)

4.1 Radiated Disturbance 30MHz to 26.5GHz

4.1.1 Test Procedure

The test site semi-anechoic chamber has met the requirement of NSA tolerance 4dB according to the standards: ANCI C63.4: 2014. The test distance was 3m. The set-up and test methods were according to ANCI C63.4: 2014.

A preliminary scan and a final scan of the emissions were made from 30 MHz to 26.5 GHz by using test script of software; The emissions were measured using Quasi-Peak Detector (30MHz~1GHz) and AV/PK detector (above 1GHz). The maximal emission value was acquired by adjusting the antenna height, polarisation and turntable azimuth in accordance with the software setup. Normally, the height range of antenna was 1m to 4m. The azimuth range of turntable was 0° to 360°. The receiving antenna has two polarizations V and H.

Measurement bandwidth (RBW) for 30MHz to 1000 MHz: 120 kHz;

Measurement bandwidth (RBW) for 1000MHz to 26500 MHz: 1MHz;

EUT was configured in idle mode and the test performed at worst emission state.

4.1.2 Test setup

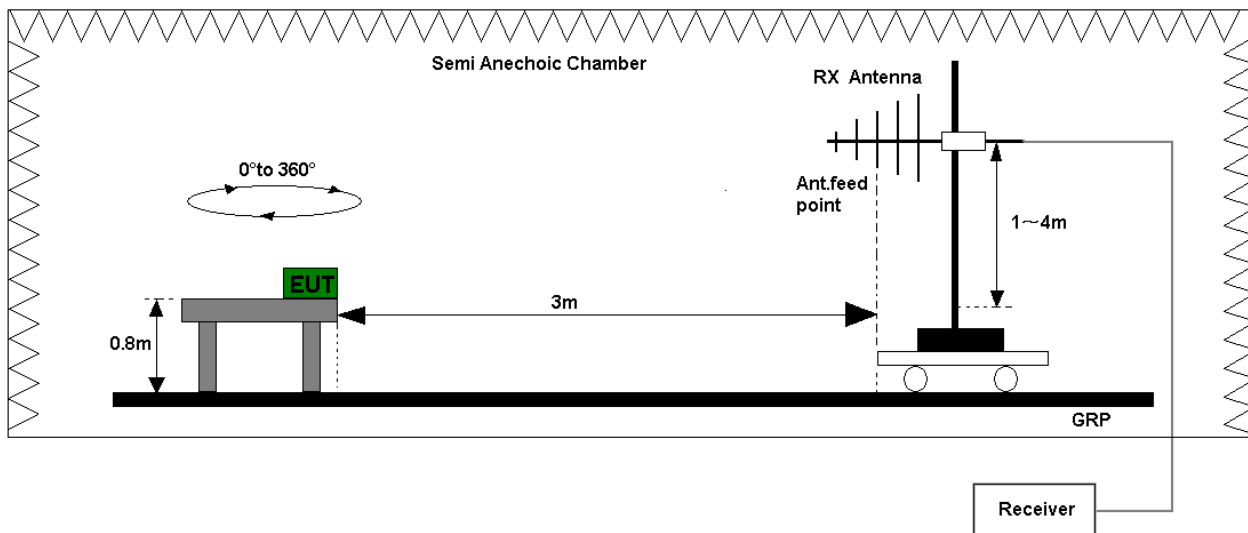

Figure 1. Test set-up of radiated disturbance(30MHz-1GHz)

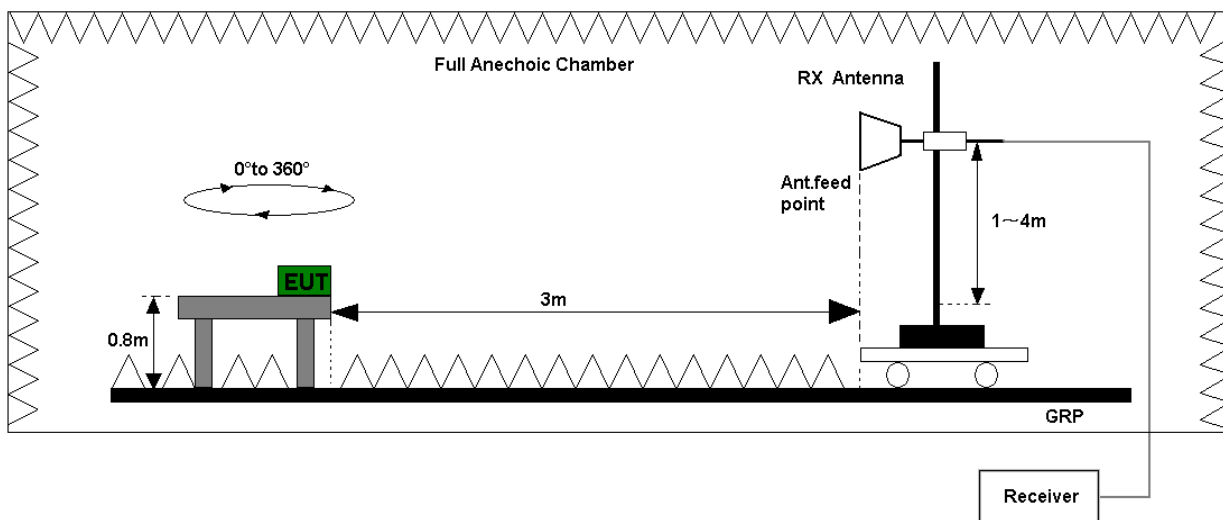

Figure 2. Test set-up of radiated disturbance(above 1GHz)

4.1.3 Test Results

The EUT has met the requirements for Radiated Emission of enclosure port.
Refer to the section 7.1.1 of this report for test data.

Test Limits (Class B)				
Frequency of Emission (MHz)	Radiated Limit			
	Unit(μ V/m)		Unit(dB μ V/m)	
30-88	100		40	
88-216	150		43.5	
216-960	200		46	
Above 960	500		54	
Above 1000	AV	PK	AV	PK
	500	5000	54	74

4.2 Conducted Disturbance 0.15 MHz to 30MHz

4.2.1 Test Procedure

The Table-top EUT was placed upon a non-metallic table 0.8 m above the horizontal metal reference ground plane. EUT was connected to LISN and LISN was connected to reference Ground Plane. EUT was 80cm away from LISN. The set-up and test methods were according to ANCI C63.4: 2014 Conducted Disturbance at AC Port measurements were undertaken on the L and N Lines. The emissions were measured using a Quasi-Peak Detector and Average Detector.

EUT was communicated with the simulator through Air interface, the simulator controls the EUT to transmitter the maximum power which defined in specification of product. The EUT operated on the typical channel.

Measurement bandwidth (RBW) for 150 kHz to 30 MHz: 9 kHz;

The EUT was set in the shielded chamber and operated under nominal conditions.

4.2.2 Test Setup

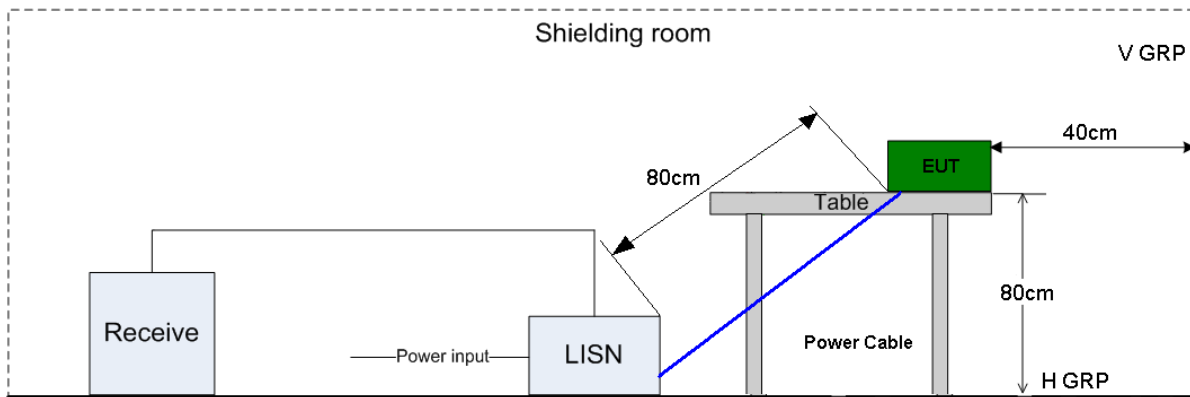

Figure 3. Test Set-up of conducted disturbance

4.2.3 Test Results

The EUT has met requirements for Conducted disturbance of power lines.

Refer to the section 7.2.1 of this report for test data.

Test Limit of AC Power Port		
Frequency range	150kHz ~ 30MHz	
Frequency	Voltage limits	
	QP (dB μ V)	AV (dB μ V)
0.15MHz~0.5MHz	66-56	56-46
0.5MHz-5MHz	56	46
5MHz~30MHz	60	50

5 Main Test Instruments

Main Test Equipments						
Test item	Test Instrument	Model	S/N	Manufacturer	Calibrated Deadline	Cal interval
RE	EMI Test Receiver&SA	N9038A	MY52260185	Agilent	Aug. 29,2019	12
	Bilog Antenna	CBL6112D	35407	TeseQ	Jun. 4,2019	12
	Double Ridge Horn Antenna	3117	119436	ETS Lindgren	Jun. 27,2019	12
	SHF-EHF Horn	AH-840	101071	com-power	Mar. 29,2019	12
	LF Amplifier	BPA-530	102209	Burgeon	Apr. 19,2019	12
	HF Amplifier(1G-18G)	AMF-7D-00101800-30-10P-R	1707137	MITEQ	Oct. 17, 2019	12
	HF Amplifier(18G-40G)	TTA1840-35-HG	1871923	MITEQ	Jul. 16,2019	12
CE	EMI Test receiver	ESCI	101163	R&S	Jan.18,2019	12
	Artificial Mains Network	ENV4200	100134	R&S	May. 07,2019	12
	Artificial Mains Network	ENV216	100382	R&S	May. 07, 2019	12
Software Information						
Test Item	Software Name	Manufacturer		Version		
RE	E3	AUDIX		6.2009-8-24(sporton)		
CE	EMC32	R&S		V9.25.0		

6 System Measurement Uncertainty

For a 95% confidence level, the measurement expanded uncertainties for defined systems, in accordance with the recommendations of ISO 17025 were:

System Measurement Uncertainty		
Items	Extended Uncertainty	
RE(30MHz-1GHz)	Field strength (dB μ V/m)	U=4.8dB; k=2
RE(1GHz-18GHz)	Field strength (dB μ V/m)	U=5dB; k=2
RE(18GHz-26.5GHz)	Field strength (dB μ V/m)	U=4.3dB; k=2
CE	Disturbance Voltage (dB μ V)	U=2.3dB; k=2

7 Test Data and Graph

Only the worst test results were shown

7.1 Radiated Disturbance

7.1.1 30MHz~1GHz

Test Mode 3: Charging+ Video Playing + Earphone +idle

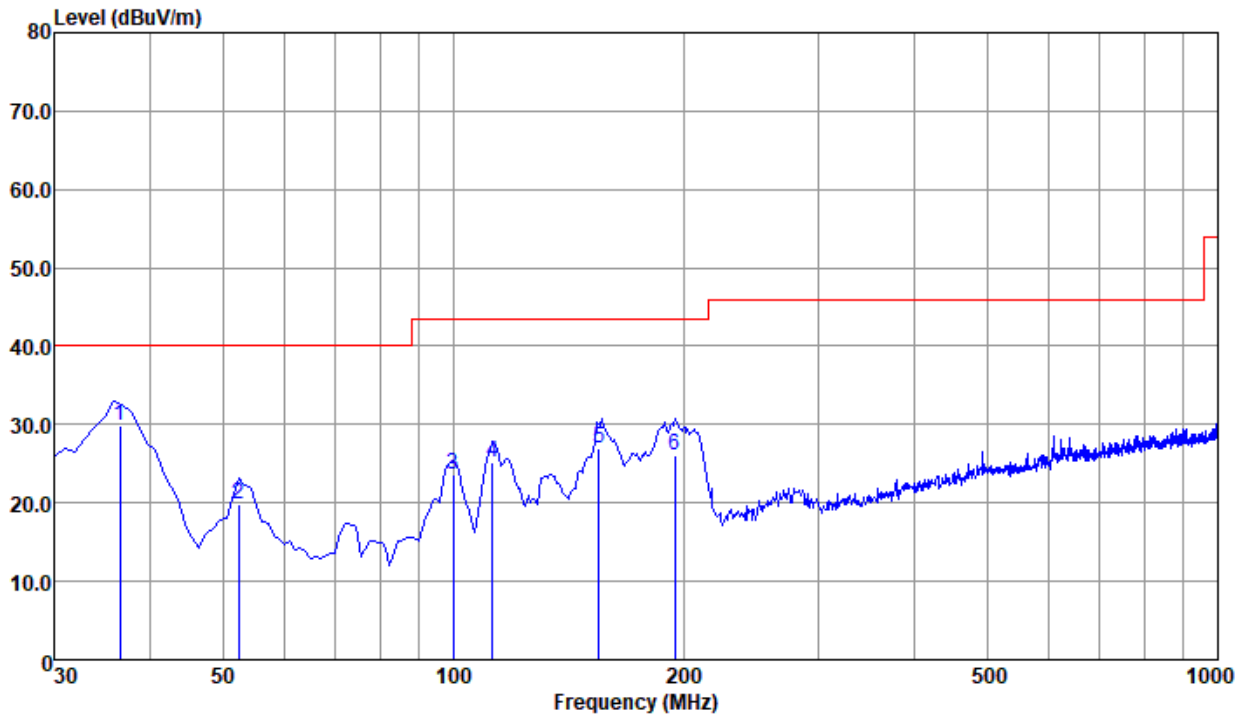

	Freq	Level	Over Limit	Limit Line	ReadAntenna Level	Antenna Factor	Cable Loss	Preamp Factor	Remark	
	MHz	dBuV/m	dB	dBuV/m	dBuV	dB/m	dB	dB		
1	pp	36.62	29.92	-10.08	40.00	40.84	20.34	0.34	31.60	QP
2		52.31	19.89	-20.11	40.00	37.24	13.76	0.49	31.60	QP
3		99.84	23.56	-19.94	43.50	37.51	16.70	0.85	31.50	QP
4		112.45	25.29	-18.21	43.50	38.30	17.50	0.97	31.48	QP
5		155.10	26.97	-16.53	43.50	40.68	16.33	1.34	31.38	QP
6		194.90	26.12	-17.38	43.50	40.24	15.50	1.59	31.21	QP

Note:

Level = Reading level by receiver + Transd (Antenna factor + cable loss – preamplifier gain)

The reading level is calculated by software which is not shown in the sheet.

7.1.2 1GHz~18GHz

Test Mode 3: Charging + Video Playing +Earphone +idle

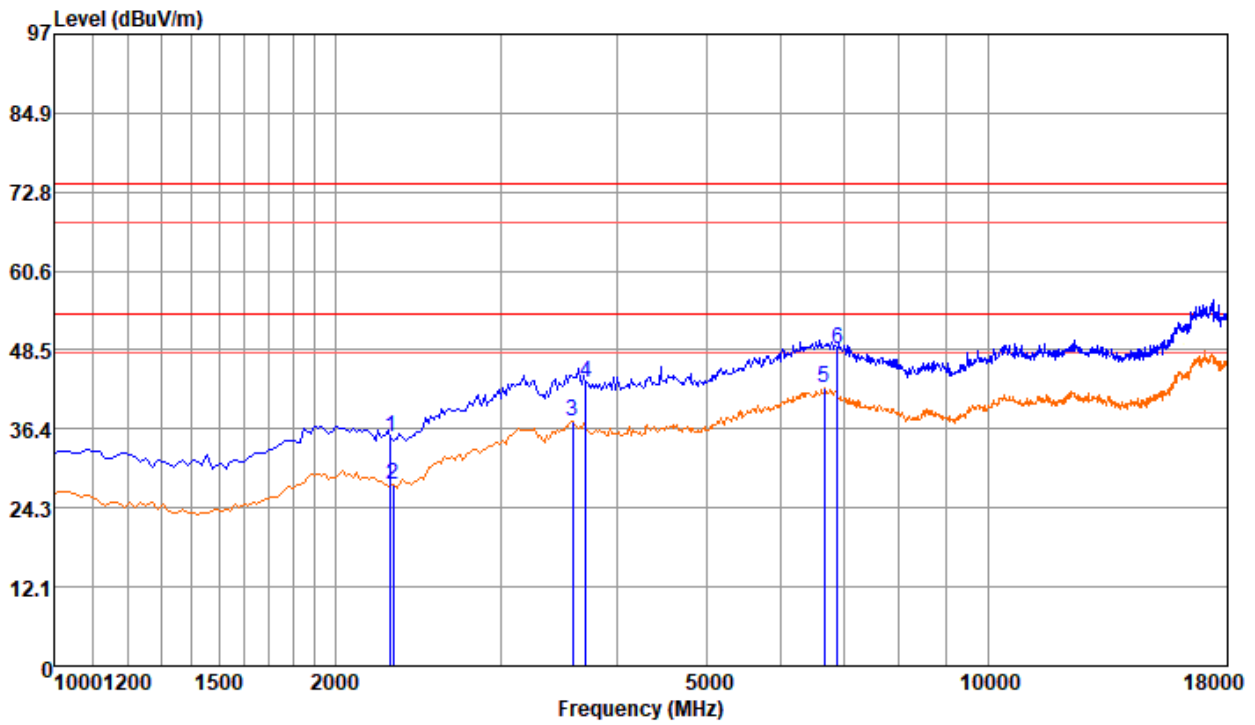

	Freq	Level	Over Limit	Limit Line	ReadAntenna Level	Antenna Factor	Cable Loss	Preamp Factor	Remark
	MHz	dBuV/m	dB	dBuV/m	dBuV	dB/m	dB	dB	
1	2292.00	35.16	-38.84	74.00	55.53	31.61	6.56	58.54	Peak
2	2307.00	27.76	-26.24	54.00	48.06	31.59	6.65	58.54	Average
3	3584.00	37.54	-16.46	54.00	52.24	34.17	9.61	58.48	Average
4	3703.00	43.51	-30.49	74.00	58.54	33.70	9.80	58.53	Peak
5 pp	6670.00	42.72	-11.28	54.00	51.23	34.99	15.63	59.13	Average
6 pk	6882.00	48.52	-25.48	74.00	57.44	34.94	15.33	59.19	Peak

Note:

Level = Reading level by receiver + Transd (Antenna factor + cable loss – preamplifier gain)

The reading level is calculated by software which is not shown in the sheet.

7.1.3 18GHz~26.5GHz

Test Mode 3: Charging + Video Playing +Earphone +idle

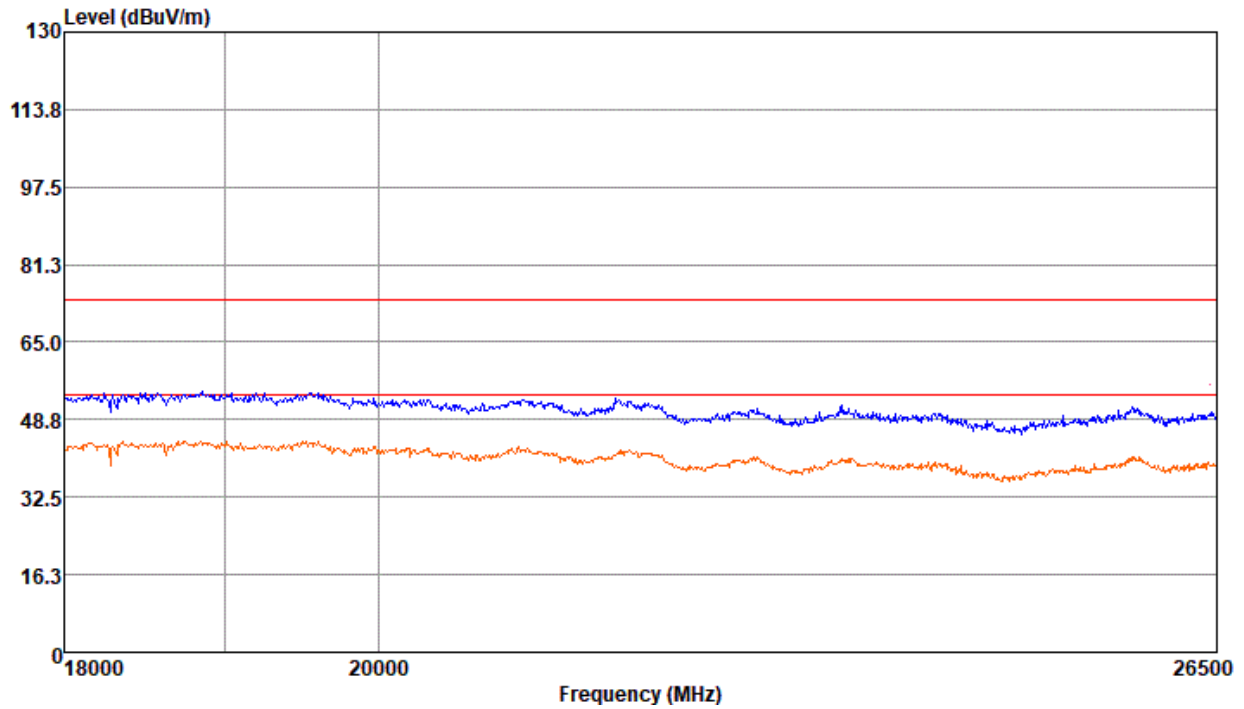

Note : No abnormalities were found in the “18 GHz to 26.5 GHz” test range, so no mark point was made.

7.2 Conducted Disturbance

7.2.1 AC Port Test Data

Test Mode 3: Charging +Video Playing +Earphone +idle

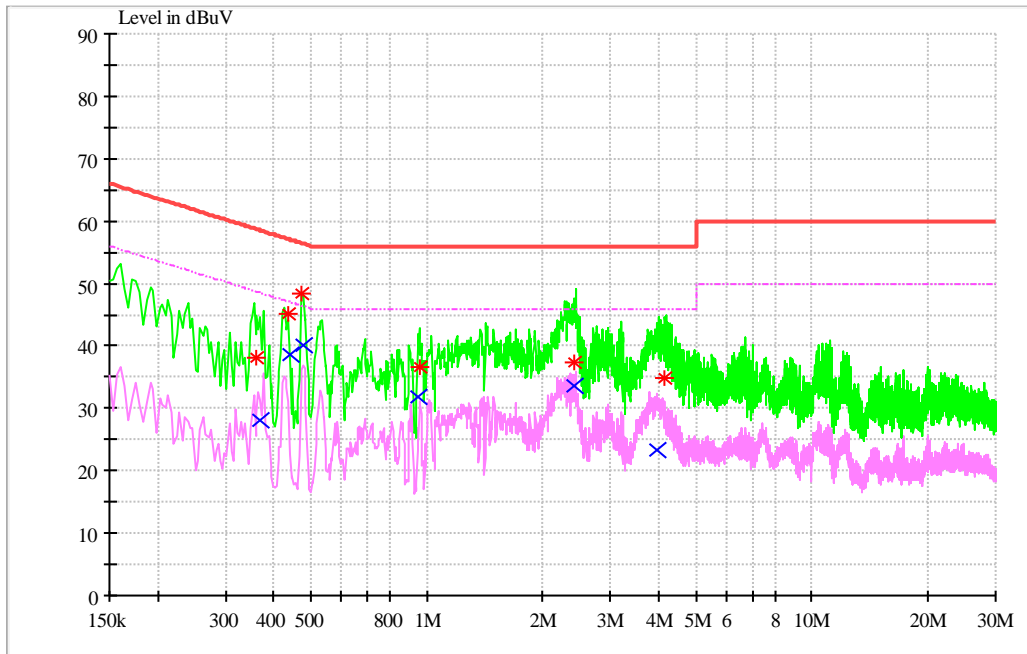

MEASUREMENT RESULT: QP Detector

Frequency MHz	Level dB μ V	Line	Transd dB	Margin dB	Limit dB μ V	PE
0.35879	37.99	N	9.7	20.76	58.75	FLO
0.438012	45.2	N	9.7	11.9	57.10	FLO
0.474477	48.33	N	9.7	8.11	56.44	FLO
0.960223	36.59	L1	9.8	19.41	56	FLO
2.419316	37.44	N	9.8	18.56	56	FLO
4.160828	34.77	N	10	21.23	56	FLO

MEASUREMENT RESULT: AV Detector

Frequency MHz	Level dB μ V	Line	Transd dB	Margin dB	Limit dB μ V	PE
0.369857	28.18	N	9.7	20.32	48.5	FLO
0.439848	38.55	N	9.7	8.51	47.06	FLO
0.475947	40.04	N	9.7	6.37	46.41	FLO
0.953559	31.85	L1	9.7	14.15	46	FLO
2.413835	33.63	N	9.7	12.37	46	FLO
3.954968	23.22	L1	9.8	22.78	46	FLO

-----END-----