

TEST REPORT

CERTIFICATE OF CONFORMITY

Standard: 47 CFR FCC Part 96
47 CFR FCC Part 2

Report No.: RFBEIH-WTW-P23030259-1

FCC ID: P27RP131CBRS-P

Product: Video Bridge Adapter

Brand: Sercomm, MosoLabs

Model No.: RP131CBRS-P

Received Date: 2023/3/8

Test Date: 2023/3/20 ~ 2023/4/11

Issued Date: 2023/4/27

Applicant: Sercomm Corp.

Address: 8F, No. 3-1, YuanQu St., NanKang, Taipei 115, Taiwan, R.O.C.

Issued By: Bureau Veritas Consumer Products Services (H.K.) Ltd., Taoyuan Branch
Lin Kou Laboratories

Lab Address: No. 47-2, 14th Ling, Chia Pau Vil., Lin Kou Dist., New Taipei City, Taiwan

Test Location: No. 19, Hwa Ya 2nd Rd., Wen Hwa Vil., Kwei Shan Dist., Taoyuan City 33383, TAIWAN

FCC Registration / 788550 / TW0003

Designation Number:

Approved by: Jeremy Lin , **Date:** 2023/4/27
Jeremy Lin / Project Engineer

This test report consists of 80 pages in total. It may be duplicated completely for legal use with the approval of the applicant. It should not be reproduced except in full, without the written approval of our laboratory. The test results in the report only apply to the tested sample. The test results in this report are traceable to the national or international standards.



Prepared by : Polly Chien / Specialist

This report is governed by, and incorporates by reference, the Conditions of Testing as posted at the date of issuance of this report at <http://www.bureauveritas.com/home/about-us/our-business/cps/about-us/terms-conditions/> and is intended for your exclusive use. Any copying or replication of this report to or for any other person or entity, or use of our name or trademark, is permitted only with our prior written permission. This report sets forth our findings solely with respect to the test samples identified herein. The results set forth in this report are not indicative or representative of the quality or characteristics of the lot from which a test sample was taken or any similar or identical product unless specifically and expressly noted. Our report includes all of the tests requested by you and the results thereof based upon the information that you provided to us. Measurement uncertainty is only provided upon request for accredited tests. Statements of conformity are based on simple acceptance criteria without taking measurement uncertainty into account, unless otherwise requested in writing. You have 60 days from date of issuance of this report to notify us of any material error or omission caused by our negligence or if you require measurement uncertainty; provided, however, that such notice shall be in writing and shall specifically address the issue you wish to raise. A failure to raise such issue within the prescribed time shall constitute your unqualified acceptance of the completeness of this report, the tests conducted and the correctness of the report contents.

Table of Contents

Release Control Record	4
1 Certificate	5
2 Summary of Test Results	6
2.1 Measurement Uncertainty	6
2.2 Supplementary Information	6
3 General Information	7
3.1 General Description of EUT	7
3.2 Antenna Description of EUT	8
3.3 Test Mode Applicability and Tested Channel Detail	9
3.4 Test Program Used and Operation Descriptions	11
3.5 Connection Diagram of EUT and Peripheral Devices	11
3.6 Configuration of Peripheral Devices and Cable Connections	11
4 Test Instruments	12
4.1 Maximum EIRP	12
4.2 Modulation Characteristics	12
4.3 Peak to Average Ratio	12
4.4 Bandwidth	12
4.5 Conducted Spurious Emissions	12
4.6 Radiated Spurious Emissions below 1GHz	13
4.7 Radiated Spurious Emissions above 1GHz	14
4.8 Frequency Stability	14
5 Limits of Test Items	15
5.1 Maximum EIRP	15
5.2 Modulation Characteristics	15
5.3 Peak to Average Ratio	15
5.4 Bandwidth	15
5.5 Conducted Spurious Emissions	15
5.6 Radiated Spurious Emissions below 1GHz	15
5.7 Radiated Spurious Emissions above 1GHz	16
5.8 Frequency Stability	16
6 Test Arrangements	17
6.1 Maximum EIRP	17
6.1.1 Test Setup	17
6.1.2 Test Procedure	17
6.2 Modulation Characteristics	18
6.2.1 Test Setup	18
6.2.2 Test Procedure	18
6.3 Peak to Average Ratio	18
6.3.1 Test Setup	18
6.3.2 Test Procedure	18
6.4 Bandwidth	19
6.4.1 Test Setup	19
6.4.2 Test Procedure	19
6.5 Conducted Spurious Emissions	21
6.5.1 Test Setup	21
6.5.2 Test Procedure	21
6.6 Radiated Spurious Emissions below 1GHz	22
6.6.1 Test Setup	22
6.6.2 Test Procedure	22
6.7 Radiated Spurious Emissions above 1GHz	23
6.7.1 Test Setup	23
6.7.2 Test Procedure	23
6.8 Frequency Stability	24
6.8.1 Test Setup	24



6.8.2	Test Procedure	24
7	Test Results of Test Item	25
7.1	Maximum EIRP	25
7.1.1	LTE Band 48	25
7.2	Modulation Characteristics	34
7.2.1	LTE Band 48	34
7.3	Peak to Average Ratio	35
7.3.1	LTE Band 48	35
7.4	Bandwidth	39
7.4.1	LTE Band 48	39
7.5	Conducted Spurious Emissions	43
7.5.1	LTE Band 48	43
7.6	Radiated Spurious Emissions below 1GHz	67
7.6.1	LTE Band 48	67
7.7	Radiated Spurious Emissions above 1GHz	69
7.7.1	LTE Band 48	69
7.8	Frequency Stability	75
7.8.1	LTE Band 48	75
8	Pictures of Test Arrangements	79
9	Information of the Testing Laboratories	80



Release Control Record

Issue No.	Description	Date Issued
RFBEIH-WTW-P23030259-1	Original release.	2023/4/27

1 Certificate

Product: Video Bridge Adapter

Brand: Sercomm, MosoLabs

Test Model: RP131CBRS-P

Sample Status: Engineering sample

Applicant: Sercomm Corp.

Test Date: 2023/3/20 ~ 2023/4/11

Standard: 47 CFR FCC Part 96
47 CFR FCC Part 2

Measurement procedure: ANSI/TIA/EIA-603-E 2016
ANSI C63.26-2015
KDB 971168 D01 Power Meas License Digital Systems v03r01
KDB 940660 D01 Part 96 CBRS Eqpt v03

The above equipment has been tested by **Bureau Veritas Consumer Products Services (H.K.) Ltd., Taoyuan Branch**, and found compliance with the requirement of the above standards. The test record, data evaluation & Equipment Under Test (EUT) configurations represented herein are true and accurate accounts of the measurements of the sample's RF characteristics under the conditions specified in this report.

2 Summary of Test Results

47 CFR FCC Part 96 & Part 2			
Standard / Clause	Test Item	Result	Remark
FCC 47 CFR Part 2.1046 FCC 47 CFR Part 96.41(b)	Maximum EIRP	Pass	Meet the requirement of limit.
FCC 47 CFR Part 2.1047	Modulation Characteristics	Pass	Meet the requirement of limit.
FCC 47 CFR Part 96.41(g)	Peak to Average Ratio	Pass	Meet the requirement of limit.
FCC 47 CFR Part 2.1049	Bandwidth	Pass	Meet the requirement of limit.
FCC 47 CFR Part 2.1051 FCC 47 CFR Part 96.41(e)	Conducted Spurious Emissions	Pass	Meet the requirement of limit.
FCC 47 CFR Part 2.1053 FCC 47 CFR Part 96.41(e)	Radiated Spurious Emissions below 1GHz	Pass	Minimum passing margin is -4.82 dB at 53.28 MHz
FCC 47 CFR Part 2.1053 FCC 47 CFR Part 96.41(e)	Radiated Spurious Emissions above 1GHz	Pass	Minimum passing margin is -3.21 dB at 7120.00 MHz
FCC 47 CFR Part 2.1055	Frequency Stability	Pass	Meet the requirement of limit.

Note: Determining compliance based on the results of the compliance measurement, not taking into account measurement instrumentation uncertainty.

2.1 Measurement Uncertainty

Where relevant, the following measurement uncertainty levels have been estimated for tests performed on the EUT as specified in CISPR 16-4-2:

Measurement	Specification	Expanded Uncertainty (k=2) (±)
Radiated Spurious Emissions below 1GHz	9kHz ~ 30MHz	2.44 dB
	30MHz ~ 200MHz	2.93 dB
	200MHz ~ 1000MHz	2.95 dB
Radiated Spurious Emissions above 1GHz	1GHz ~ 18GHz	2.26 dB
	18GHz ~ 40GHz	1.94 dB

The other instruments specified are routine verified to remain within the calibrated levels, no measurement uncertainty is required to be calculated.

2.2 Supplementary Information

There is not any deviation from the test standards for the test method, and no modifications required for compliance.

3 General Information

3.1 General Description of EUT

Product	Video Bridge Adapter
Brand	Sercomm, MosoLabs
Test Model	RP131CBRS-P
Status of EUT	Engineering sample
Power Supply Rating	120Vac, 0.6A

Note:

1. EUT Overview

Full Maximum EIRP (dBm/channel bandwidth)

Band / Bandwidth	TX Frequency Range (MHz)	Max. EIRP Power	
		QPSK	16QAM
LTE Band 48 (Channel Bandwidth 5MHz)	3552.5-3697.5	194.536mW (22.89dBm/channel bandwidth)	192.752mW (22.85dBm/channel bandwidth)
LTE Band 48 (Channel Bandwidth 10MHz)	3555.0-3695.0	193.197mW (22.86dBm/channel bandwidth)	191.426mW (22.82dBm/channel bandwidth)
LTE Band 48 (Channel Bandwidth 15MHz)	3557.5-3692.5	193.197mW (22.86dBm/channel bandwidth)	186.209mW (22.70dBm/channel bandwidth)
LTE Band 48 (Channel Bandwidth 20MHz)	3560.0-3690.0	193.642mW (22.87dBm/channel bandwidth)	191.867mW (22.83dBm/channel bandwidth)

Maximum EIRP (dBm/10MHz)

Band / Bandwidth	TX Frequency Range (MHz)	Max. EIRP Power	
		QPSK	16QAM
LTE Band 48 (Channel Bandwidth 5MHz)	3552.5-3697.5	194.536mW (22.89dBm/10MHz)	192.752mW (22.85dBm/10MHz)
LTE Band 48 (Channel Bandwidth 10MHz)	3555.0-3695.0	193.197mW (22.86dBm/10MHz)	191.426mW (22.82dBm/10MHz)
LTE Band 48 (Channel Bandwidth 15MHz)	3557.5-3692.5	186.638mW (22.71dBm/10MHz)	179.887mW (22.55dBm/10MHz)
LTE Band 48 (Channel Bandwidth 20MHz)	3560.0-3690.0	187.932mW (22.74dBm/10MHz)	185.780mW (22.69dBm/10MHz)

Band / Bandwidth	TX Frequency Range (MHz)	Emission Designator	
		QPSK	16QAM
LTE Band 48 (Channel Bandwidth 5MHz)	3552.5-3697.5	4M48G7D	4M48D7W
LTE Band 48 (Channel Bandwidth 10MHz)	3555.0-3695.0	8M93G7D	8M92D7W
LTE Band 48 (Channel Bandwidth 15MHz)	3557.5-3692.5	13M4G7D	13M4D7W
LTE Band 48 (Channel Bandwidth 20MHz)	3560.0-3690.0	17M9G7D	17M9D7W

2. The above EUT information is declared by manufacturer and for more detailed features description, please refers to the manufacturer's specifications or user's manual.

3.2 Antenna Description of EUT

1. The antenna information is listed as below.

Antenna No.	Antenna Type	Antenna Connector	Gain (dBi)
ANT 1 (1TX 1RX)	PIFA	Murata	2.9
ANT 2 (1RX)	PIFA	I-Pex	2.8

* The above Antenna information is declared by manufacturer and for more detailed features description, please refer to the manufacturer's specifications, the laboratory shall not be held responsible.

3.3 Test Mode Applicability and Tested Channel Detail

Pre-Scan:	EUT can be used in the following ways: X-axis/ Y-axis/ Z-axis. Pre-scan these ways and find the worst case as a representative test condition.
Worst Case:	X-axis/ Y-axis/ Z-axis Worst Condition: X-axis

Test Item	Tested Channel	Channel Bandwidth	Modulation	Mode
EIRP	55265 (3552.50 MHz) 55990 (3625.00 MHz) 56715 (3697.50 MHz)	5 MHz	QPSK / 16QAM	1 RB Half RB Full RB
	55290 (3555.00 MHz) 55990 (3625.00 MHz) 56690 (3695.00 MHz)	10 MHz	QPSK / 16QAM	1 RB Half RB Full RB
	55315 (3557.50 MHz) 55990 (3625.00 MHz) 56665 (3692.50 MHz)	15 MHz	QPSK / 16QAM	1 RB Half RB Full RB
	55340 (3560.00 MHz) 55990 (3625.00 MHz) 56640 (3690.00 MHz)	20 MHz	QPSK / 16QAM	1 RB Half RB Full RB
Modulation Characteristics	55990 (3625.00 MHz)	20 MHz	QPSK / 16QAM	Full RB
Frequency Stability	55265 (3552.50 MHz) 56715 (3697.50 MHz)	5 MHz	QPSK	Full RB
	55290 (3555.00 MHz) 56690 (3695.00 MHz)	10 MHz	QPSK	Full RB
	55315 (3557.50 MHz) 56665 (3692.50 MHz)	15 MHz	QPSK	Full RB
	55340 (3560.00 MHz) 56640 (3690.00 MHz)	20 MHz	QPSK	Full RB
Occupied Bandwidth	55265 (3552.50 MHz) 55990 (3625.00 MHz) 56715 (3697.50 MHz)	5 MHz	QPSK / 16QAM	Full RB
	55290 (3555.00 MHz) 55990 (3625.00 MHz) 56690 (3695.00 MHz)	10 MHz	QPSK / 16QAM	Full RB
	55315 (3557.50 MHz) 55990 (3625.00 MHz) 56665 (3692.50 MHz)	15 MHz	QPSK / 16QAM	Full RB
	55340 (3560.00 MHz) 55990 (3625.00 MHz) 56640 (3690.00 MHz)	20 MHz	QPSK / 16QAM	Full RB
Peak to Average Ratio	55265 (3552.50 MHz) 55990 (3625.00 MHz) 56715 (3697.50 MHz)	5 MHz	QPSK / 16QAM	1 RB
	55290 (3555.00 MHz) 55990 (3625.00 MHz) 56690 (3695.00 MHz)	10 MHz	QPSK / 16QAM	1 RB
	55315 (3557.50 MHz) 55990 (3625.00 MHz) 56665 (3692.50 MHz)	15 MHz	QPSK / 16QAM	1 RB
	55340 (3560.00 MHz) 55990 (3625.00 MHz) 56640 (3690.00 MHz)	20 MHz	QPSK / 16QAM	1 RB



Test Item	Tested Channel	Channel Bandwidth	Modulation	Mode
Conducted Emission	55265 (3552.50 MHz) 55990 (3625.00 MHz) 56715 (3697.50 MHz)	5 MHz	QPSK	1 RB Full RB
	55290 (3555.00 MHz) 55990 (3625.00 MHz) 56690 (3695.00 MHz)	10 MHz	QPSK	1 RB Full RB
	55315 (3557.50 MHz) 55990 (3625.00 MHz) 56665 (3692.50 MHz)	15 MHz	QPSK	1 RB Full RB
	55340 (3560.00 MHz) 55990 (3625.00 MHz) 56640 (3690.00 MHz)	20 MHz	QPSK	1 RB Full RB
RE Below 1GHz	55340 (3560.00 MHz)	20 MHz	QPSK	1 RB
RE Above 1GHz	55265 (3552.50 MHz) 55990 (3625.00 MHz) 56715 (3697.50 MHz)	5 MHz	QPSK	1 RB
	55340 (3560.00 MHz) 55990 (3625.00 MHz) 56640 (3690.00 MHz)	20 MHz	QPSK	1 RB

3.4 Test Program Used and Operation Descriptions

There is no need to controlling software during the test, and the EUT can be paired with the Radio Communication Analyzer to test the connection when it is powered on.

3.5 Connection Diagram of EUT and Peripheral Devices

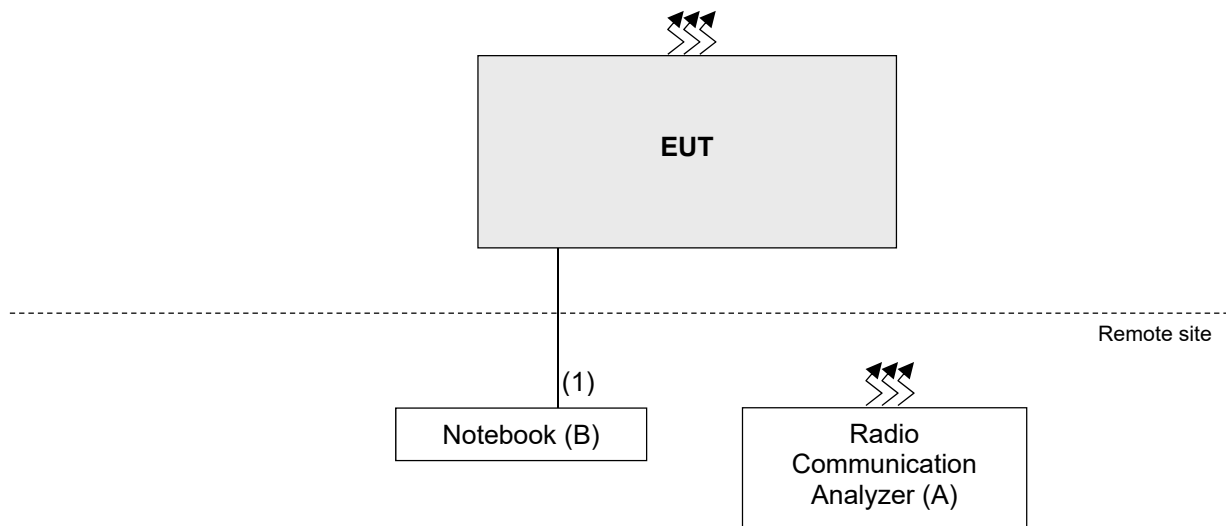

3.6 Configuration of Peripheral Devices and Cable Connections

ID	Product	Brand	Model No.	Serial No.	FCC ID	Remarks
A	Radio Communication Analyzer	Anritsu	MT8821C	6201462755	N/A	Provided by Lab
B	Notebook	Lenovo	X250ALT5	PC06HPSE	N/A	Provided by Client

ID	Cable Descriptions	Qty.	Length (m)	Shielding (Yes/No)	Cores (Qty.)	Remarks
1	LAN Cable	1	10	N	0	Provided by Lab

4 Test Instruments

The calibration interval of the all test instruments are 12 months and the calibrations are traceable to NML/ROC and NIST/USA.

4.1 Maximum EIRP

Description Manufacturer	Model No.	Serial No.	Calibrated Date	Calibrated Until
N9030B - PXA Signal Analyzer KEYSIGHT	N9030B	MY57140488	2023/3/06	2024/3/05
Radio Communication Analyzer Anritsu	MT8821C	6201462755	2023/3/3	2024/3/2
Software BV	ADT_RF Test Software V6.6.5.4	N/A	N/A	N/A

Notes:

1. The test was performed in Oven room.
2. Tested Date: 2023/4/11

4.2 Modulation Characteristics

Description Manufacturer	Model No.	Serial No.	Calibrated Date	Calibrated Until
N9030B - PXA Signal Analyzer KEYSIGHT	N9030B	MY57140938	2023/3/16	2024/3/15
Radio Communication Analyzer Anritsu	MT8821C	6201462755	2023/3/3	2024/3/2
Software BV	ADT_RF Test Software V6.6.5.4	N/A	N/A	N/A

Notes:

1. The test was performed in Oven room.
2. Tested Date: 2023/4/11

4.3 Peak to Average Ratio

1. Refer to section 4.2 to get information of the instruments.
2. Tested Date: 2023/3/23

4.4 Bandwidth

1. Refer to section 4.2 to get information of the instruments.
2. Tested Date: 2023/3/24

4.5 Conducted Spurious Emissions

1. Refer to section 4.2 to get information of the instruments.
2. Tested Date: 2023/3/24-2023/4/11

4.6 Radiated Spurious Emissions below 1GHz

Description Manufacturer	Model No.	Serial No.	Calibrated Date	Calibrated Until
Signal Analyzer Agilent	N9010A	MY52220314	2022/12/09	2023/12/08
Loop Antenna TESEQ	HLA 6121	45745	2022/07/27	2023/07/26
Pre-amplifier EMCI	EMC001340	980142	2022/06/02	2023/06/01
RF Coaxial Cable EMCI	5D-NM-BM	140903+140902	2023/01/07	2024/01/06
Preamplifier EMCI	EMC 330H	980112	2022/10/01	2023/09/30
BILOG Antenna SCHWARZBECK	VULB 9168	9168-472	2022/10/21	2023/10/20
RF Coaxial Cable WOKEN	8D-FB	Cable-Ch10-01	2022/09/15	2023/09/14
HORN Antenna SCHWARZBECK	BBHA 9120D	9120D-969	2022/11/13	2023/11/12
Preamplifier EMCI	EMC 012645	980115	2022/10/01	2023/09/30
RF Coaxial Cable EMCI	EMC104-SM-SM-8000	171005	2022/10/01	2023/09/30
RF Coaxial Cable HUBER+SUHNER	SUCOFLEX 104	EMC104-SM-SM-1000(140807)	2022/10/01	2023/09/30
RF FLITER MICRO-TRONICS	BRM50716	060	2023/01/11	2024/01/10
RF FLITER MICRO-TRONICS	BRM17690	004	2023/01/11	2024/01/10
Broadband Horn Antenna SCHWARZBECK	BBHA 9170	148	2022/11/13	2023/11/12
RF Coaxial Cable HUBER+SUHNER&EMCI	SUCOFLEX 104& EMC104-SM-SM8000	CABLE-CH9-02 (248780+171006)	2023/01/07	2024/01/06
RF Coaxial Cable HUBER+SUHNER	SUCOFLEX 104	CABLE-CH9-(250795/4)	2023/01/07	2024/01/06
RF Coaxial Cable EMCI	EMC102-KM-KM-600	150928	2022/07/09	2023/07/08
RF Coaxial Cable EMCI	EMC102-KM-KM-3000	150929	2022/07/09	2023/07/08
Software BV ADT	ADT_Radiated_ V7.6.15.9.5	NA	NA	NA
Antenna Tower Max-Full	MFA-440H	AT93021705	NA	NA
Turn Table Max-Full	MFT-201SS	NA	NA	NA
Antenna Tower & Turn Table Controller Max-Full	MF-7802	NA	NA	NA
Boresight antenna tower fixture BV	BAF-02	7	NA	NA
Radio Communication Analyzer Anritsu	MT8821C	6201462755	2023/03/03	2024/03/02

Notes:

1. The test was performed in HY - 966 chamber 5.
2. Tested Date: 2023/3/20

4.7 Radiated Spurious Emissions above 1GHz

Refer to section 4.6 to get information of the instruments.

4.8 Frequency Stability

Description Manufacturer	Model No.	Serial No.	Calibrated Date	Calibrated Until
AC Power Supply Extech	CFW-105	E000603	N/A	N/A
Digital Multimeter Fluke	87-III	70360742	2022/6/23	2023/6/22
Software BV	ADT_RF Test Software V6.6.5.4	N/A	N/A	N/A
Spectrum Analyzer R&S	FSV40	100980	2022/4/20	2023/4/19
Temperature & Humidity Chamber TERCHY	HRM-120RF	931022	2022/12/27	2023/12/26
Radio Communication Analyzer Anritsu	MT8821C	6201462755	2023/3/3	2024/3/2

Notes:

1. The test was performed in Oven room.
2. Tested Date: 2023/4/11

5 Limits of Test Items

5.1 Maximum EIRP

Device		Maximum EIRP (dBm/10 MHz)
<input checked="" type="checkbox"/>	End User Device	23
<input type="checkbox"/>	Category A CBSD	30
<input type="checkbox"/>	Category B CBSD	47

5.2 Modulation Characteristics

A curve or equivalent data which shows that the equipment will meet the modulation requirements of the rules under which the equipment is to be licensed.

5.3 Peak to Average Ratio

In measuring transmissions in this band using an average power technique, the peak to-average ratio (PAR) of the transmission may not exceed 13 dB.

5.4 Bandwidth

According to FCC 47 CFR part 2.1049, the occupied bandwidth, that is the frequency bandwidth such that, below its lower and above its upper frequency limits, the mean powers radiated are each equal to 0.5% of the total mean power radiated by a given emission.

5.5 Conducted Spurious Emissions

Power of any emissions outside the Fundamental	Limit
Within 0-10MHz above the Assigned Channel	-13 dBm/MHz
Within 0-10MHz below the Assigned Channel	
Greater than 10MHz above the Assigned Channel	-25 dBm/MHz
Greater than 10MHz below the Assigned Channel	
Power of any emission below 3530MHz	-40 dBm/MHz
Power of any emission above 3720MHz	

5.6 Radiated Spurious Emissions below 1GHz

Power of any emissions outside the Fundamental	Limit
Within 0-10MHz above the Assigned Channel	-13 dBm/MHz
Within 0-10MHz below the Assigned Channel	
Greater than 10MHz above the Assigned Channel	-25 dBm/MHz
Greater than 10MHz below the Assigned Channel	
Power of any emission below 3530MHz	-40 dBm/MHz
Power of any emission above 3720MHz	

5.7 Radiated Spurious Emissions above 1GHz

Power of any emissions outside the Fundamental	Limit
Within 0-10MHz above the Assigned Channel	-13 dBm/MHz
Within 0-10MHz below the Assigned Channel	
Greater than 10MHz above the Assigned Channel	-25 dBm/MHz
Greater than 10MHz below the Assigned Channel	
Power of any emission below 3530MHz	-40 dBm/MHz
Power of any emission above 3720MHz	

5.8 Frequency Stability

The frequency stability shall be sufficient to ensure that the fundamental emissions stay within the authorized bands of operation (authorized frequency block).

6 Test Arrangements

6.1 Maximum EIRP

6.1.1 Test Setup

Conducted Power Measurement:

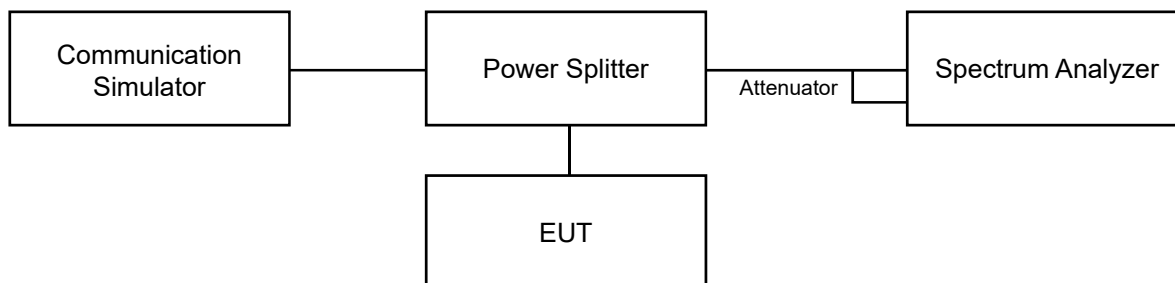

6.1.2 Test Procedure

Conducted Power Measurement:

The EUT is configured by emulator to set data modulation and maximum power using WWAN technology. The power measurement was performed on emulator and power value was measured from power function on emulator. Set the EUT to transmit under low, middle and high channel and record the power level shown on simulator.

Measurement method refers to ANSI C63.26 section 5.2.4.4.

- a. Set span to $2 \times$ to $3 \times$ the OBW.
- b. Set RBW = 1% to 5% of the OBW.
- c. Set VBW $\geq 3 \times$ RBW.
- d. Set number of measurement points in sweep $\geq 2 \times$ span / RBW.
- e. Set Sweep time = auto-couple.
- f. Detector = power averaging (rms).
- g. Set sweep trigger to "free run."
- h. Trace average at least 100 traces in power averaging (rms) mode.
- i. Compute power by integrating the spectrum across the OBW of the signal using the instrument's band or channel power measurement function with band/channel limits set equal to the OBW band edges.
- j. If Duty cycle < 98%, Add $10 \log (1/\text{duty cycle})$ to the measured power level to compute the average power during continuous transmission.
- k. For per 10MHz method, channel power integrating bandwidth 10MHz is used for bandwidth 5M, 10M, 15M and 20M. For full power method, channel power integrating bandwidth 10MHz is used for bandwidth 5M, 10M, integrating bandwidth 15MHz is used for bandwidth 15M, integrating bandwidth 20MHz is used for bandwidth 20M.

Maximum EIRP / ERP

The relevant equation for determining the maximum ERP or EIRP from the measured RF output power is given in Equation as follows:

$$\text{EIRP} = P_{\text{Meas}} + G_{\text{T}}$$

$$\text{ERP} = P_{\text{Meas}} + G_{\text{T}} - 2.15$$

where

ERP or EIRP effective radiated power or equivalent isotropically radiated power, respectively

(expressed in the same units as P_{Meas} , e.g., dBm or dBW)

P_{Meas} measured transmitter output power or PSD, in dBm or dBW

G_{T} gain of the transmitting antenna, in dBd (ERP) or dBi (EIRP)

6.2 Modulation Characteristics

6.2.1 Test Setup

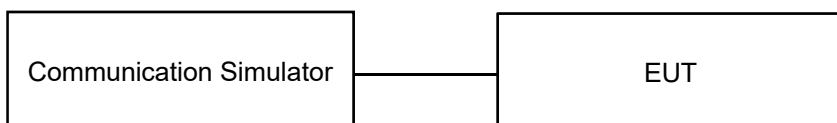

6.2.2 Test Procedure

Connect the EUT to Communication Simulator via the antenna connector, the frequency band is set as EUT supported Modulation and Channels, the EUT output is matched with 50 ohm load, the waveform quality and constellation of the EUT was tested.

6.3 Peak to Average Ratio

6.3.1 Test Setup

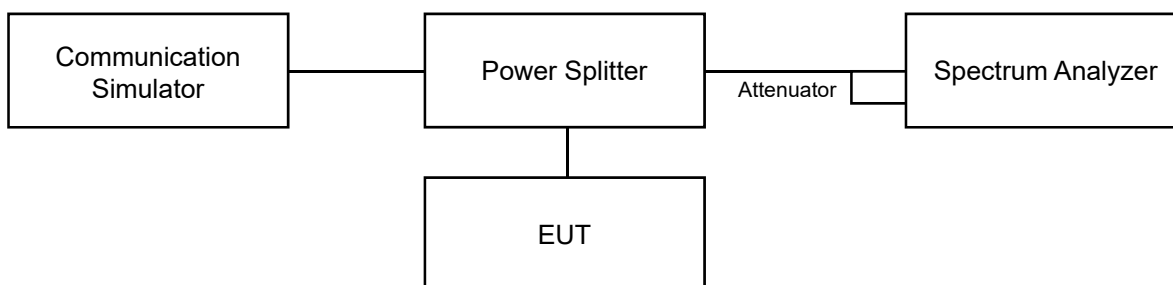

6.3.2 Test Procedure

- Set resolution/measurement bandwidth \geq signal's occupied bandwidth;
- Set the number of counts to a value that stabilizes the measured CCDF curve;
- Record the maximum PAPR level associated with a probability of 0.1%.

6.4 Bandwidth

6.4.1 Test Setup

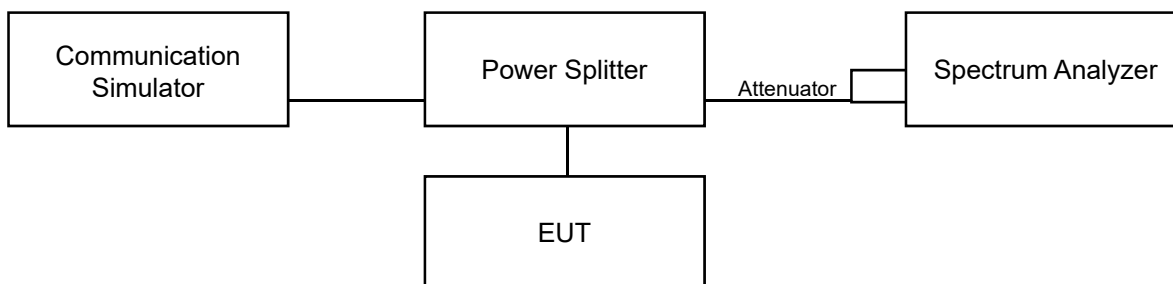

6.4.2 Test Procedure

For the 26 dBc bandwidth measurement method, please refer to section 5.4.3 of ANSI C63.26.

- a. The spectrum analyzer center frequency is set to the nominal EUT channel center frequency. The span range for the spectrum analyzer shall be wide enough to see sufficient roll off of the signal to make the measurement.
- b. The nominal RBW shall be in the range of 1% to 5% of the anticipated OBW, and the VBW shall be set $\geq 3 \times$ RBW.
- c. Set the reference level of the instrument as required to prevent the signal amplitude from exceeding the maximum spectrum analyzer input mixer level for linear operation. See guidance provided in 4.2.3.
- d. The dynamic range of the spectrum analyzer at the selected RBW shall be more than 10 dB below the target “-X dB” requirement, i.e., if the requirement calls for measuring the -26 dB OBW, the spectrum analyzer noise floor at the selected RBW shall be at least 36 dB below the reference level.
- e. Set spectrum analyzer detection mode to peak, and the trace mode to max hold.
- f. Determine the following reference values: Set the EUT to transmit a modulated signal. Allow the trace to stabilize. Set the spectrum analyzer marker to the highest level of the displayed trace (this is the reference value).
- g. Determine the “-X dB amplitude” as equal to (Reference Value - X). Alternatively, this calculation can be performed on the spectrum analyzer using the delta-marker measurement function.
- h. Place two markers, one at the lowest and the other at the highest frequency of the envelope of the spectral display such that each marker is at or slightly below the “-X dB amplitude” determined in step f). If a marker is below this “-X dB amplitude” value it should be as close as possible to this value. The OBW is the positive frequency difference between the two markers.
- i. The OBW shall be reported by providing plot(s) of the measuring instrument display, to include markers depicting the relevant frequency and amplitude information (e.g., marker table). The frequency and amplitude axis and scale shall be clearly labeled. Tabular data may be reported in addition to the plot(s).

For the occupied bandwidth measurement method, please refer to section 5.4.4 of ANSI C63.26.

- a. The spectrum analyzer center frequency is set to the nominal EUT channel center frequency. The span range for the spectrum analyzer shall be wide enough to see sufficient roll off of the signal to make the measurement.
- b. The nominal RBW shall be in the range of 1% to 5% of the anticipated OBW, and the VBW shall be set $\geq 3 \times$ RBW.
- c. Set the reference level of the instrument as required to prevent the signal amplitude from exceeding the maximum spectrum analyzer input mixer level for linear operation. See guidance provided in 4.2.3.
- d. The dynamic range of the spectrum analyzer at the selected RBW shall be more than 10 dB below the target “-X dB” requirement, i.e., if the requirement calls for measuring the -26 dB OBW, the spectrum analyzer noise floor at the selected RBW shall be at least 36 dB below the reference level.
- e. Set spectrum analyzer detection mode to peak, and the trace mode to max hold.
- f. Determine the reference value by either of the following:
 - g. 1) Set the EUT to transmit a modulated signal. Allow the trace to stabilize. Set the spectrum analyzer marker to the highest level of the displayed trace (this is the reference value).
 - h. 2) Set the EUT to transmit an unmodulated carrier. Set the spectrum analyzer marker to the level of the carrier.
- i. Determine the “-X dB amplitude” as equal to (Reference Value - X). Alternatively, this calculation can be performed on the spectrum analyzer using the delta-marker measurement function.
- j. If the reference value was determined using an unmodulated carrier, turn the EUT modulation on, then either clear the existing trace or start a new trace on the spectrum analyzer and allow the new trace to stabilize. Otherwise the trace from step f) shall be used for step i).
- k. Place two markers, one at the lowest and the other at the highest frequency of the envelope of the spectral display such that each marker is at or slightly below the “-X dB amplitude” determined in step f). If a marker is below this “-X dB amplitude” value it should be as close as possible to this value. The OBW is the positive frequency difference between the two markers. The spectral envelope can cross the “-X dB amplitude” at multiple points. The lowest or highest frequency shall be selected as the frequencies that are the farthest away from the center frequency at which the spectral envelope crosses the “-X dB amplitude.”
- l. The OBW shall be reported by providing plot(s) of the measuring instrument display, to include markers depicting the relevant frequency and amplitude information (e.g., marker table). The frequency and amplitude axis and scale shall be clearly labeled. Tabular data may be reported in addition to the plot(s).

6.5 Conducted Spurious Emissions

6.5.1 Test Setup

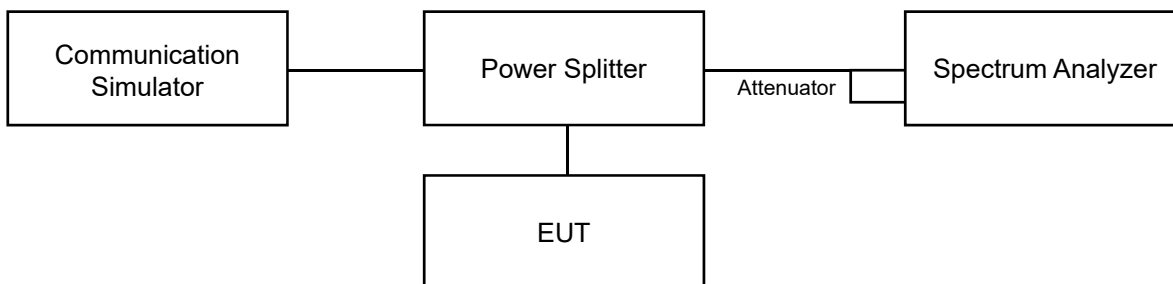

6.5.2 Test Procedure

- a. Measurement refer to ANSI C63.26 section 5.7.
- b. All measurements were done at 3 channels: low, middle and high operational frequency range.
- c. Measuring frequency range is from 9 kHz up to the tenth harmonic of the highest fundamental frequency or to 40 GHz, whichever is lower. 20 dB attenuation pad is connected with spectrum.
- d. The fundamental frequency above 1 GHz, the spectrum set RBW = 1 MHz, VBW = 3 MHz, Detector = Average.
- e. The fundamental frequency below 1 GHz, the spectrum set RBW \geq 100 kHz, VBW \geq 3 x RBW, Detector = Average.
- f. Measuring frequency band edge, narrow RBW (no less than 1% of the OBW) is used for conducted emission measurement.

6.6 Radiated Spurious Emissions below 1GHz

6.6.1 Test Setup

For radiated emission 30 MHz to 1 GHz

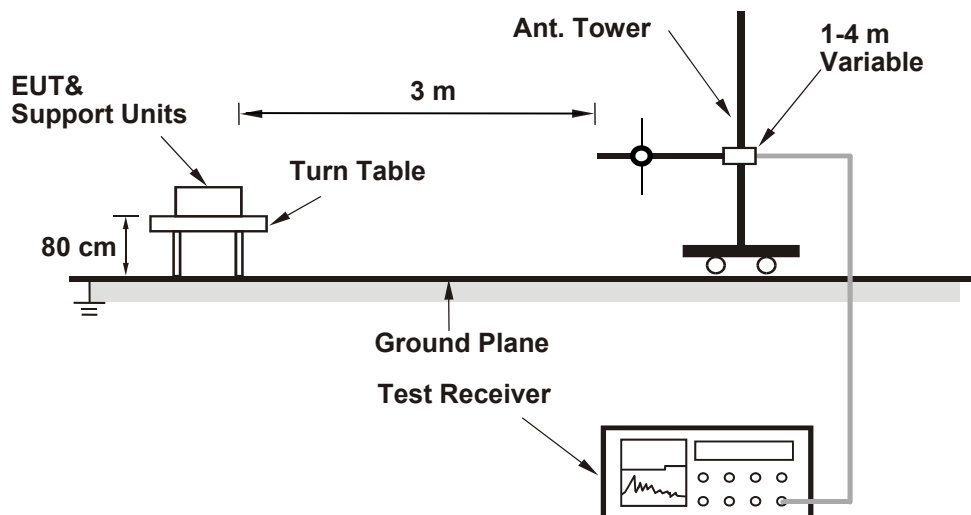

For the actual test configuration, please refer to the attached file (Test Setup Photo).

6.6.2 Test Procedure

The EUT is configured by emulator to set data modulation and maximum power using WWAN technology.

- In the semi-anechoic chamber, EUT placed on the 0.8 m (below or equal 1 GHz) height of turn table, rotated the table around 360 degrees to search the maximum radiation power and receiver antenna shall be rotated vertical and horizontal polarization and moved height from 1 m to 4 m to find the maximum polar radiated power. The "Read Value" is the spectrum reading the maximum power value.
- The height of antenna is varied from one meter to four meters above the ground to determine the maximum value of the field strength. Both horizontal and vertical polarizations of the antenna are set to make the measurement.
- Perform a field strength measurement and record the worse read value, is the field strength value via a spectrum reading obtained corrected for antenna factor, cable loss and pre-amplifier factor and then mathematically convert the measured field strength level to EIRP/ERP level.
- Following C63.26 section 5.5 and 5.2.7
- $EIRP (dBm) = E (dB\mu V/m) + 20\log(D) - 104.8$; where D is the measurement distance (in the far field region) in m.
- $ERP (dBm) = E (dB\mu V/m) + 20\log(D) - 104.8 - 2.15$; where D is the measurement distance (in the far field region) in m.

Note:

- The resolution bandwidth and video bandwidth of test receiver/spectrum analyzer is 1 MHz/3 MHz.
- The emission levels were against the limit of frequency range 9 kHz ~ 30 MHz:
The amplitude of spurious emissions attenuated more than 20 dB below the permissible value is not required to be report.

6.7 Radiated Spurious Emissions above 1GHz

6.7.1 Test Setup

For radiated emission above 1 GHz

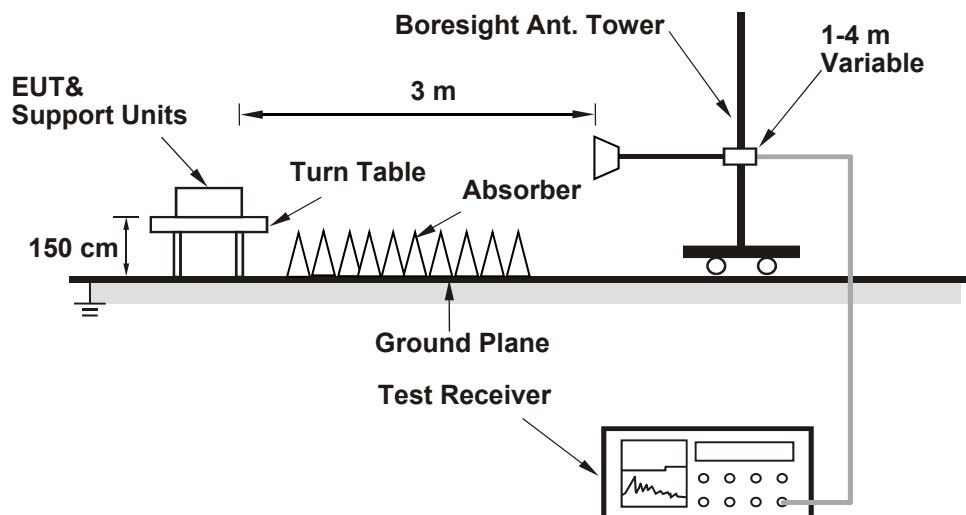

For the actual test configuration, please refer to the attached file (Test Setup Photo).

6.7.2 Test Procedure

The EUT is configured by emulator to set data modulation and maximum power using WWAN technology.

- In the semi-anechoic chamber, EUT placed on the 1.5 m height of turn table, rotated the table around 360 degrees to search the maximum radiation power and receiver antenna shall be rotated vertical and horizontal polarization and moved height from 1 m to 4 m to find the maximum polar radiated power. The "Read Value" is the spectrum reading the maximum power value.
- The height of antenna is varied from one meter to four meters above the ground to determine the maximum value of the field strength. Both horizontal and vertical polarizations of the antenna are set to make the measurement.
- Perform a field strength measurement and record the worse read value, is the field strength value via a spectrum reading obtained corrected for antenna factor, cable loss and pre-amplifier factor and then mathematically convert the measured field strength level to EIRP/ERP level.
- Following C63.26 section 5.5 and 5.2.7
- $EIRP (dBm) = E (dB\mu V/m) + 20\log(D) - 104.8$; where D is the measurement distance (in the far field region) in m.
- $ERP (dBm) = E (dB\mu V/m) + 20\log(D) - 104.8 - 2.15$; where D is the measurement distance (in the far field region) in m.

Note:

- The resolution bandwidth and video bandwidth of test receiver/spectrum analyzer is 1 MHz/3 MHz.

6.8 Frequency Stability

6.8.1 Test Setup

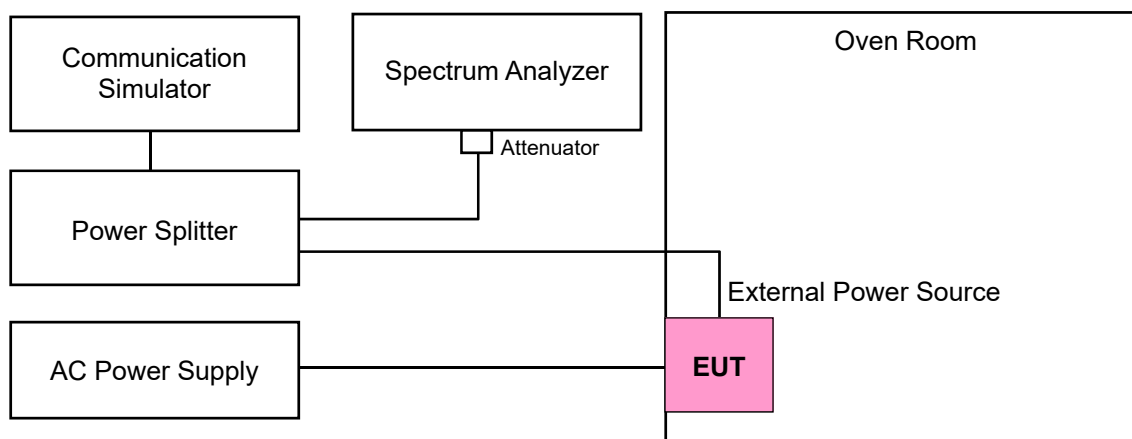

6.8.2 Test Procedure

The EUT is configured by emulator to set data modulation and maximum power using WWAN technology.

- Device is placed at the oven room. The oven room could control the temperatures and humidity. Power warm up is at least 15 min and power applied should perform before recording frequency error.
- EUT is connected the external power supply to control the AC input power. The test voltage range is from minimum to maximum working voltage. Each step shall be record the frequency error rate.
- The temperature range step is 10 degrees in this test items. All temperature levels shall be hold the $\pm 0.5^{\circ}\text{C}$ during the measurement testing. The each temperature step shall be at least 0.5 hours, consider the EUT could be test under the stability condition.

Note: The frequency error was recorded frequency error from the communication simulator.

7 Test Results of Test Item

7.1 Maximum EIRP

Input Power:	120Vac, 60Hz	Environmental Conditions:	22°C, 72% RH	Tested By:	James Yang
--------------	--------------	---------------------------	--------------	------------	------------

7.1.1 LTE Band 48

Full Conducted Output Power (dBm/channel bandwidth)

LTE Band 48						
BW	MCS Index	RB Size	RB Offset	Low	Mid	High
		Channel		55340	55990	56640
		Frequency (MHz)		3560	3625	3690
20M	QPSK	1	0	18.35	19.97	17.26
		1	50	18.29	19.88	17.20
		1	99	18.28	19.94	17.25
		50	0	18.30	19.76	17.18
		50	25	18.26	19.92	17.16
		50	50	18.28	19.73	17.21
		100	0	18.26	19.82	17.13
20M	16QAM	1	0	18.33	19.71	17.25
		1	50	18.30	19.93	17.16
		1	99	18.24	19.74	17.23
		50	0	18.30	19.91	17.22
		50	25	18.22	19.82	17.15
		50	50	18.26	19.91	17.13
		100	0	18.22	19.83	17.11
LTE Band 48						
BW	MCS Index	RB Size	RB Offset	Low	Mid	High
		Channel		55315	55990	56665
		Frequency (MHz)		3557.5	3625	3692.5
15M	QPSK	1	0	17.94	19.96	17.05
		1	37	17.85	19.73	16.99
		1	74	17.87	19.90	17.01
		36	0	17.90	19.84	17.02
		36	19	17.86	19.73	16.96
		36	39	17.88	19.74	16.99
		75	0	17.88	19.75	16.98
15M	16QAM	1	0	17.89	19.76	17.03
		1	37	17.85	19.73	16.96
		1	74	17.88	19.72	16.87
		36	0	17.79	19.80	16.92
		36	19	17.80	19.79	17.00
		36	39	17.76	19.70	17.01
		75	0	17.83	19.79	16.87

LTE Band 48						
BW	MCS Index	RB Size	RB Offset	Low	Mid	High
		Channel		55290	55990	56690
		Frequency (MHz)		3555	3625	3695
10M	QPSK	1	0	19.96	19.94	19.86
		1	24	19.74	19.71	19.91
		1	49	19.83	19.81	19.83
		25	0	19.70	19.77	19.91
		25	12	19.78	19.93	19.77
		25	25	19.83	19.90	19.83
		50	0	19.85	19.72	19.94
10M	16QAM	1	0	19.70	19.70	19.70
		1	24	19.89	19.75	19.83
		1	49	19.89	19.74	19.88
		25	0	19.82	19.92	19.89
		25	12	19.83	19.91	19.87
		25	25	19.71	19.78	19.78
		50	0	19.88	19.73	19.81
LTE Band 48						
BW	MCS Index	RB Size	RB Offset	Low	Mid	High
		Channel		55265	55990	56715
		Frequency (MHz)		3552.5	3625	3697.5
5M	QPSK	1	0	19.99	19.88	19.79
		1	12	19.83	19.74	19.88
		1	24	19.87	19.88	19.84
		12	0	19.75	19.93	19.93
		12	6	19.77	19.81	19.80
		12	13	19.77	19.87	19.91
		25	0	19.76	19.74	19.90
5M	16QAM	1	0	19.94	19.78	19.95
		1	12	19.74	19.94	19.89
		1	24	19.76	19.91	19.71
		12	0	19.76	19.79	19.76
		12	6	19.90	19.77	19.73
		12	13	19.81	19.86	19.75
		25	0	19.91	19.75	19.82

Conducted Output Power (dBm/ 10MHz)

LTE Band 48						
BW	MCS Index	RB Size	RB Offset	Low	Mid	High
		Channel		55340	55990	56640
		Frequency (MHz)		3560	3625	3690
20M	QPSK	1	0	18.19	19.84	17.11
		1	50	18.16	19.71	17.02
		1	99	18.12	19.77	17.06
		50	0	18.20	19.60	17.06
		50	25	18.09	19.82	17.05
		50	50	18.15	19.57	17.04
		100	0	15.70	17.33	14.90
20M	16QAM	1	0	18.18	19.59	17.05
		1	50	18.19	19.79	17.04
		1	99	18.06	19.64	17.04
		50	0	18.14	19.73	17.03
		50	25	18.02	19.67	16.99
		50	50	18.16	19.72	16.94
		100	0	15.65	17.21	14.85
LTE Band 48						
BW	MCS Index	RB Size	RB Offset	Low	Mid	High
		Channel		55315	55990	56665
		Frequency (MHz)		3557.5	3625	3692.5
15M	QPSK	1	0	17.75	19.81	16.91
		1	37	17.73	19.57	16.88
		1	74	17.77	19.72	16.90
		36	0	17.79	19.74	16.92
		36	19	17.69	19.63	16.86
		36	39	17.70	19.55	16.83
		75	0	16.44	18.33	15.81
15M	16QAM	1	0	17.75	19.58	16.84
		1	37	17.66	19.55	16.82
		1	74	17.78	19.62	16.75
		36	0	17.68	19.64	16.77
		36	19	17.64	19.65	16.80
		36	39	17.64	19.50	16.85
		75	0	16.32	18.38	15.74

LTE Band 48						
BW	MCS Index	RB Size	RB Offset	Low	Mid	High
		Channel		55290	55990	56690
		Frequency (MHz)		3555	3625	3695
10M	QPSK	1	0	19.96	19.94	19.86
		1	24	19.74	19.71	19.91
		1	49	19.83	19.81	19.83
		25	0	19.70	19.77	19.91
		25	12	19.78	19.93	19.77
		25	25	19.83	19.90	19.83
		50	0	19.85	19.72	19.94
10M	16QAM	1	0	19.70	19.70	19.70
		1	24	19.89	19.75	19.83
		1	49	19.89	19.74	19.88
		25	0	19.82	19.92	19.89
		25	12	19.83	19.91	19.87
		25	25	19.71	19.78	19.78
		50	0	19.88	19.73	19.81
LTE Band 48						
BW	MCS Index	RB Size	RB Offset	Low	Mid	High
		Channel		55265	55990	56715
		Frequency (MHz)		3552.5	3625	3697.5
5M	QPSK	1	0	19.99	19.88	19.79
		1	12	19.83	19.74	19.88
		1	24	19.87	19.88	19.84
		12	0	19.75	19.93	19.93
		12	6	19.77	19.81	19.80
		12	13	19.77	19.87	19.91
		25	0	19.76	19.74	19.90
5M	16QAM	1	0	19.94	19.78	19.95
		1	12	19.74	19.94	19.89
		1	24	19.76	19.91	19.71
		12	0	19.76	19.79	19.76
		12	6	19.90	19.77	19.73
		12	13	19.81	19.86	19.75
		25	0	19.91	19.75	19.82



Spectrum Plot of Worst Value

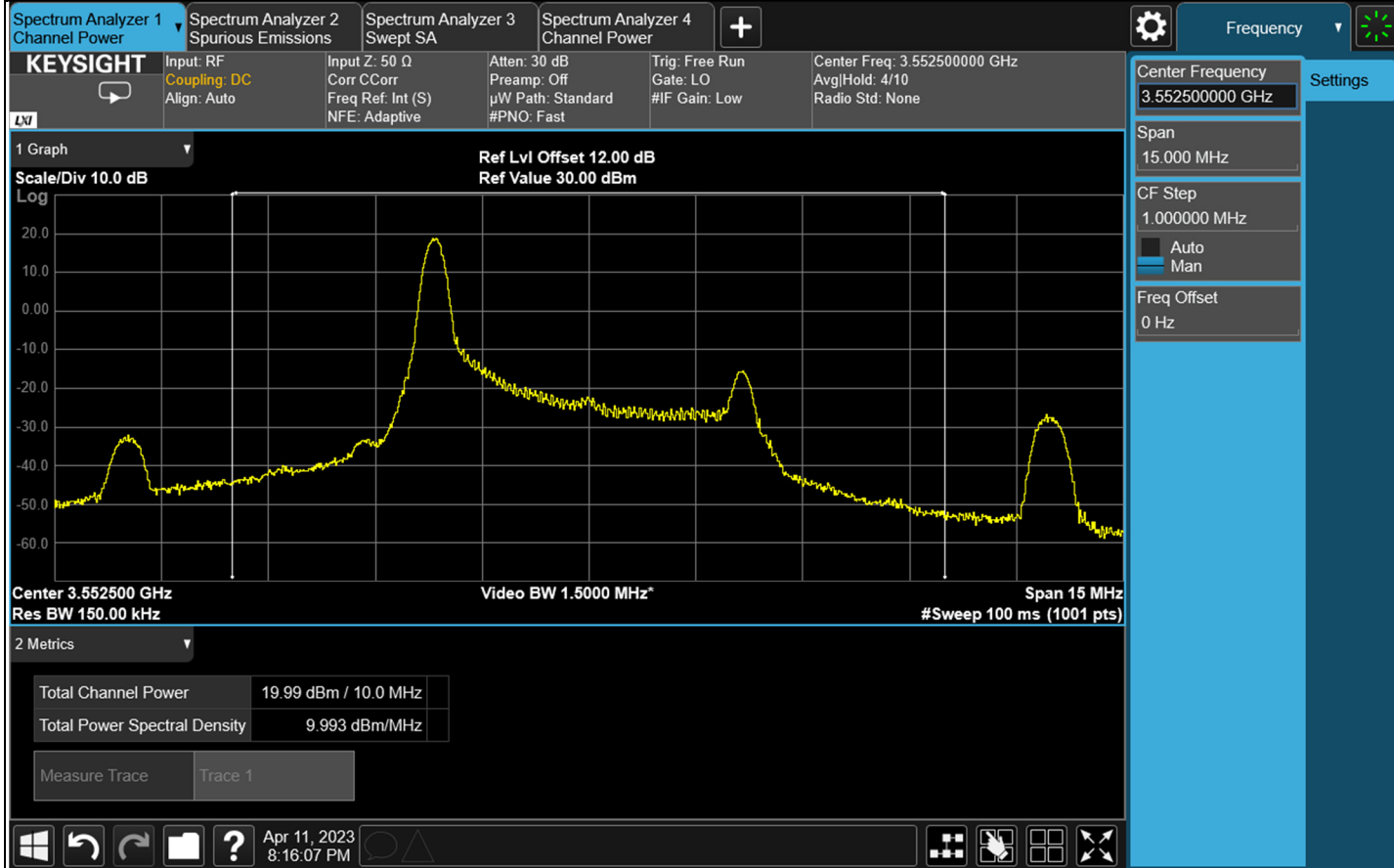

Full Maximum EIRP (dBm/channel bandwidth)

LTE Band 48						
BW	MCS Index	RB Size	RB Offset	Low	Mid	High
		Channel		55340	55990	56640
		Frequency (MHz)		3560	3625	3690
20M	QPSK	1	0	21.25	22.87	20.16
		1	50	21.19	22.78	20.10
		1	99	21.18	22.84	20.15
		50	0	21.20	22.66	20.08
		50	25	21.16	22.82	20.06
		50	50	21.18	22.63	20.11
		100	0	21.16	22.72	20.03
20M	16QAM	1	0	21.23	22.61	20.15
		1	50	21.20	22.83	20.06
		1	99	21.14	22.64	20.13
		50	0	21.20	22.81	20.12
		50	25	21.12	22.72	20.05
		50	50	21.16	22.81	20.03
		100	0	21.12	22.73	20.01
LTE Band 48						
BW	MCS Index	RB Size	RB Offset	Low	Mid	High
		Channel		55315	55990	56665
		Frequency (MHz)		3557.5	3625	3692.5
15M	QPSK	1	0	20.84	22.86	19.95
		1	37	20.75	22.63	19.89
		1	74	20.77	22.80	19.91
		36	0	20.80	22.74	19.92
		36	19	20.76	22.63	19.86
		36	39	20.78	22.64	19.89
		75	0	20.78	22.65	19.88
15M	16QAM	1	0	20.79	22.66	19.93
		1	37	20.75	22.63	19.86
		1	74	20.78	22.62	19.77
		36	0	20.69	22.70	19.82
		36	19	20.70	22.69	19.90
		36	39	20.66	22.60	19.91
		75	0	20.73	22.69	19.77

*EIRP (dBm / Channel Bandwidth) = Conducted Output Power (dBm / Channel Bandwidth) + Antenna Gain (dBi).

LTE Band 48						
BW	MCS Index	RB Size	RB Offset	Low	Mid	High
		Channel		55290	55990	56690
		Frequency (MHz)		3555	3625	3695
10M	QPSK	1	0	22.86	22.84	22.76
		1	24	22.64	22.61	22.81
		1	49	22.73	22.71	22.73
		25	0	22.60	22.67	22.81
		25	12	22.68	22.83	22.67
		25	25	22.73	22.80	22.73
		50	0	22.75	22.62	22.84
10M	16QAM	1	0	22.60	22.60	22.60
		1	24	22.79	22.65	22.73
		1	49	22.79	22.64	22.78
		25	0	22.72	22.82	22.79
		25	12	22.73	22.81	22.77
		25	25	22.61	22.68	22.68
		50	0	22.78	22.63	22.71
LTE Band 48						
BW	MCS Index	RB Size	RB Offset	Low	Mid	High
		Channel		55265	55990	56715
		Frequency (MHz)		3552.5	3625	3697.5
5M	QPSK	1	0	22.89	22.78	22.69
		1	12	22.73	22.64	22.78
		1	24	22.77	22.78	22.74
		12	0	22.65	22.83	22.83
		12	6	22.67	22.71	22.70
		12	13	22.67	22.77	22.81
		25	0	22.66	22.64	22.80
5M	16QAM	1	0	22.84	22.68	22.85
		1	12	22.64	22.84	22.79
		1	24	22.66	22.81	22.61
		12	0	22.66	22.69	22.66
		12	6	22.80	22.67	22.63
		12	13	22.71	22.76	22.65
		25	0	22.81	22.65	22.72

*EIRP (dBm / Channel Bandwidth) = Conducted Output Power (dBm / Channel Bandwidth) + Antenna Gain (dBi).

Maximum EIRP (dBm/10MHz)

LTE Band 48						
BW	MCS Index	RB Size	RB Offset	Low	Mid	High
		Channel		55340	55990	56640
		Frequency (MHz)		3560	3625	3690
20M	QPSK	1	0	21.09	22.74	20.01
		1	50	21.06	22.61	19.92
		1	99	21.02	22.67	19.96
		50	0	21.10	22.50	19.96
		50	25	20.99	22.72	19.95
		50	50	21.05	22.47	19.94
		100	0	18.60	20.23	17.80
20M	16QAM	1	0	21.08	22.49	19.95
		1	50	21.09	22.69	19.94
		1	99	20.96	22.54	19.94
		50	0	21.04	22.63	19.93
		50	25	20.92	22.57	19.89
		50	50	21.06	22.62	19.84
		100	0	18.55	20.11	17.75
LTE Band 48						
BW	MCS Index	RB Size	RB Offset	Low	Mid	High
		Channel		55315	55990	56665
		Frequency (MHz)		3557.5	3625	3692.5
15M	QPSK	1	0	20.65	22.71	19.81
		1	37	20.63	22.47	19.78
		1	74	20.67	22.62	19.80
		36	0	20.69	22.64	19.82
		36	19	20.59	22.53	19.76
		36	39	20.60	22.45	19.73
		75	0	19.34	21.23	18.71
15M	16QAM	1	0	20.65	22.48	19.74
		1	37	20.56	22.45	19.72
		1	74	20.68	22.52	19.65
		36	0	20.58	22.54	19.67
		36	19	20.54	22.55	19.70
		36	39	20.54	22.40	19.75
		75	0	19.22	21.28	18.64

*EIRP (dBm /10MHz) = Conducted Output Power (dBm / 10MHz)) + Antenna Gain (dBi).

LTE Band 48						
BW	MCS Index	RB Size	RB Offset	Low	Mid	High
		Channel		55290	55990	56690
		Frequency (MHz)		3555	3625	3695
10M	QPSK	1	0	22.86	22.84	22.76
		1	24	22.64	22.61	22.81
		1	49	22.73	22.71	22.73
		25	0	22.60	22.67	22.81
		25	12	22.68	22.83	22.67
		25	25	22.73	22.80	22.73
		50	0	22.75	22.62	22.84
10M	16QAM	1	0	22.60	22.60	22.60
		1	24	22.79	22.65	22.73
		1	49	22.79	22.64	22.78
		25	0	22.72	22.82	22.79
		25	12	22.73	22.81	22.77
		25	25	22.61	22.68	22.68
		50	0	22.78	22.63	22.71
LTE Band 48						
BW	MCS Index	RB Size	RB Offset	Low	Mid	High
		Channel		55265	55990	56715
		Frequency (MHz)		3552.5	3625	3697.5
5M	QPSK	1	0	22.89	22.78	22.69
		1	12	22.73	22.64	22.78
		1	24	22.77	22.78	22.74
		12	0	22.65	22.83	22.83
		12	6	22.67	22.71	22.70
		12	13	22.67	22.77	22.81
		25	0	22.66	22.64	22.80
5M	16QAM	1	0	22.84	22.68	22.85
		1	12	22.64	22.84	22.79
		1	24	22.66	22.81	22.61
		12	0	22.66	22.69	22.66
		12	6	22.80	22.67	22.63
		12	13	22.71	22.76	22.65
		25	0	22.81	22.65	22.72

*EIRP (dBm /10MHz) = Conducted Output Power (dBm / 10MHz)) + Antenna Gain (dBi).

7.2 Modulation Characteristics

Input Power:	120Vac, 60Hz	Environmental Conditions:	22°C, 72% RH	Tested By:	James Yang
--------------	--------------	---------------------------	--------------	------------	------------

7.2.1 LTE Band 48

LTE Band 48, Channel Bandwidth: 20 MHz

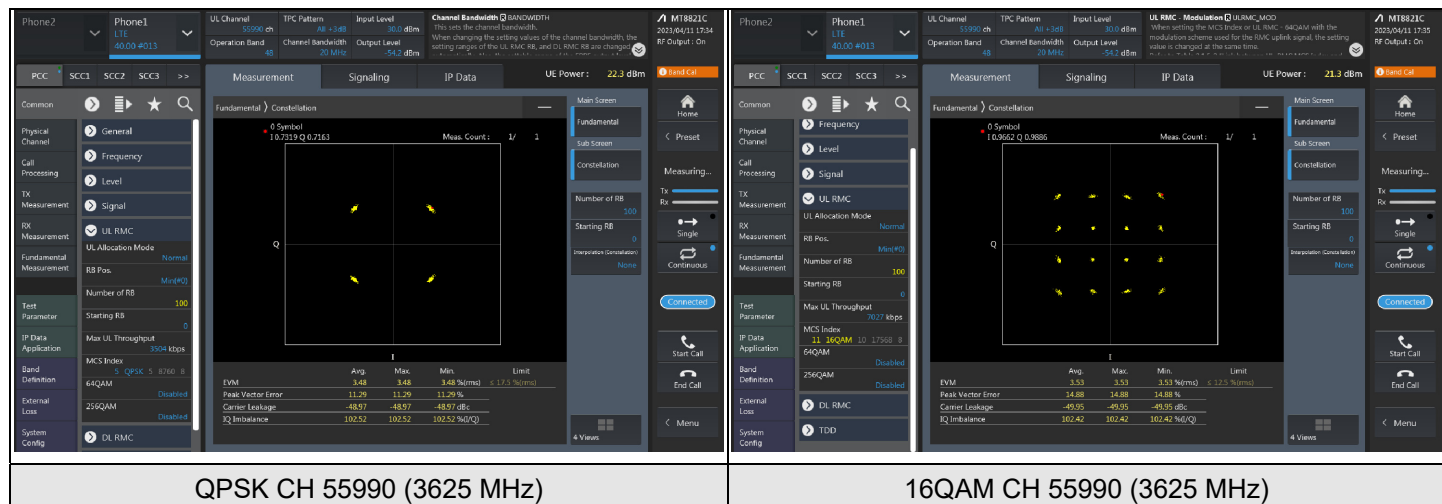

7.3 Peak to Average Ratio

Input Power:	120Vac, 60Hz	Environmental Conditions:	22°C, 72% RH	Tested By:	James Yang
--------------	--------------	---------------------------	--------------	------------	------------

7.3.1 LTE Band 48

LTE Band 48, Channel Bandwidth: 5 MHz

Modulation	Channel	Frequency (MHz)	Measurement Value(dB)	Limit (dB)	Result
QPSK	55265	3552.5	6.39	13	PASS
QPSK	55990	3625	6.16	13	PASS
QPSK	56715	3697.5	5.43	13	PASS
16QAM	55265	3552.5	6.94	13	PASS
16QAM	55990	3625	6.66	13	PASS
16QAM	56715	3697.5	6.49	13	PASS

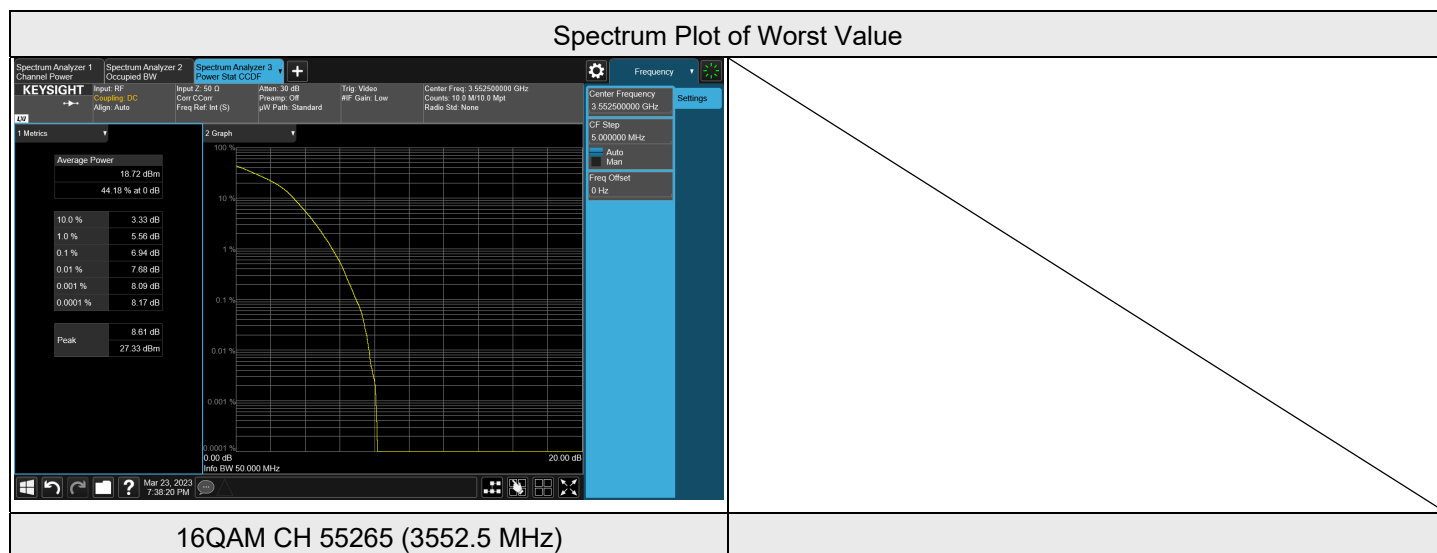

LTE Band 48, Channel Bandwidth: 10 MHz

Modulation	Channel	Frequency (MHz)	Measurement Value(dB)	Limit (dB)	Result
QPSK	55290	3555	6.31	13	PASS
QPSK	55990	3625	6.21	13	PASS
QPSK	56690	3695	5.57	13	PASS
16QAM	55290	3555	6.92	13	PASS
16QAM	55990	3625	6.75	13	PASS
16QAM	56690	3695	6.57	13	PASS

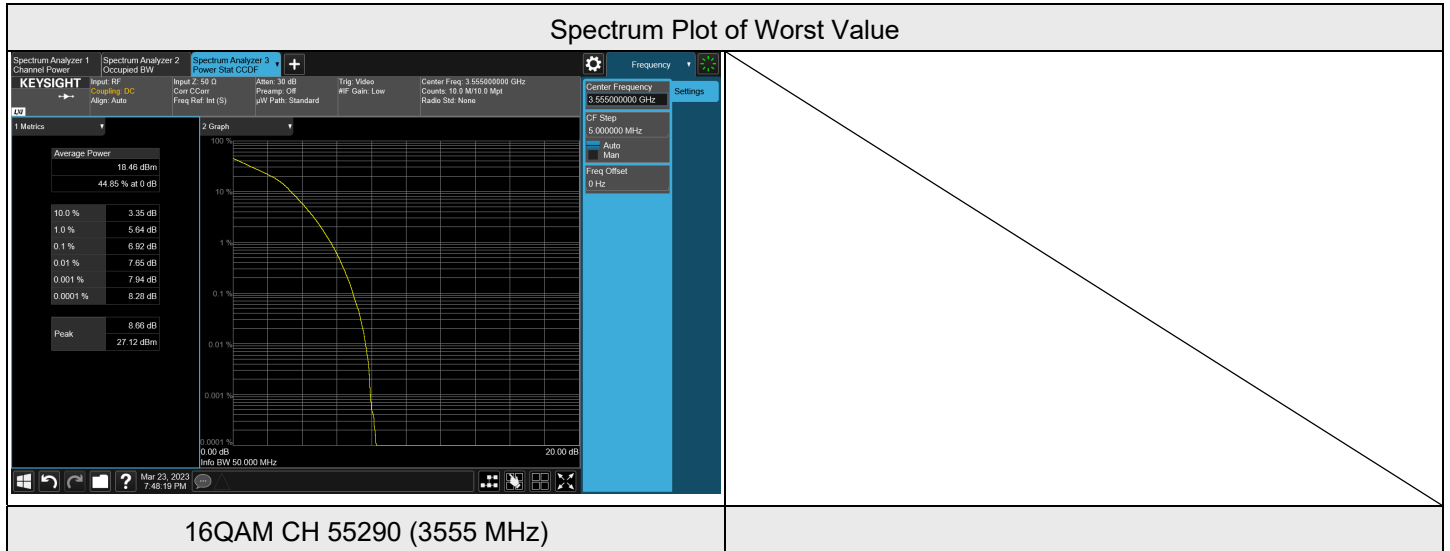

LTE Band 48, Channel Bandwidth: 15 MHz

Modulation	Channel	Frequency (MHz)	Measurement Value(dB)	Limit (dB)	Result
QPSK	55315	3557.5	6.24	13	PASS
QPSK	55990	3625	6.04	13	PASS
QPSK	56665	3692.5	5.71	13	PASS
16QAM	55315	3557.5	7.00	13	PASS
16QAM	55990	3625	6.80	13	PASS
16QAM	56665	3692.5	6.67	13	PASS

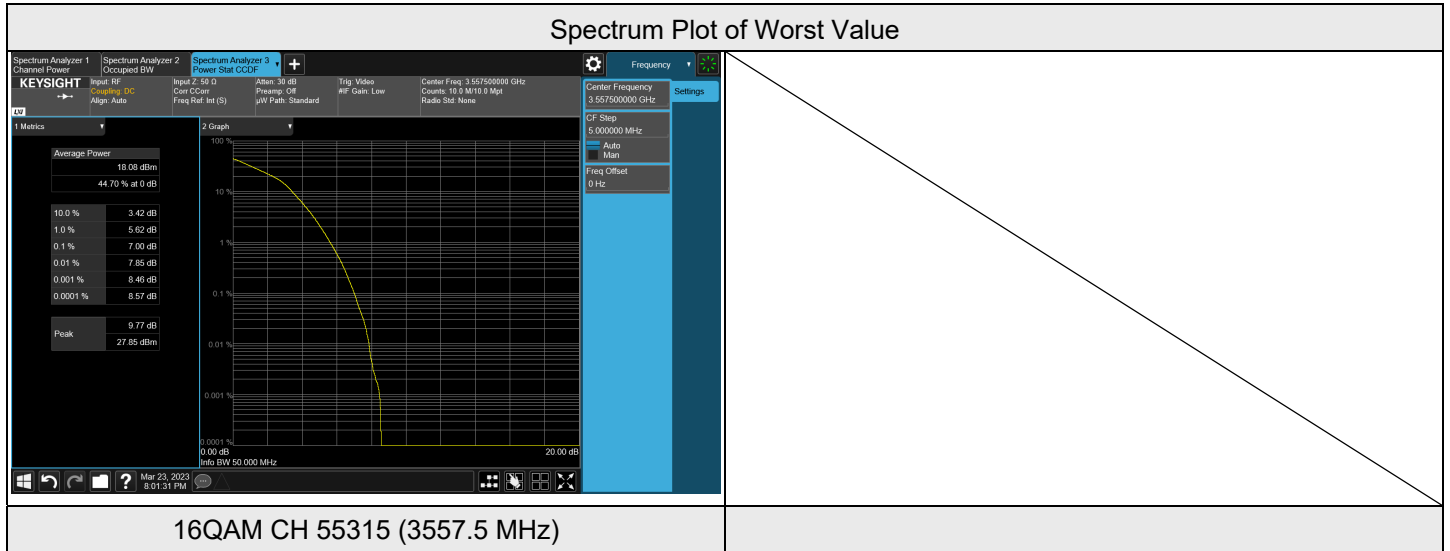

LTE Band 48, Channel Bandwidth: 20 MHz

Modulation	Channel	Frequency (MHz)	Measurement Value(dB)	Limit (dB)	Result
QPSK	55340	3560	6.27	13	PASS
QPSK	55990	3625	6.09	13	PASS
QPSK	56640	3690	5.67	13	PASS
16QAM	55340	3560	7.10	13	PASS
16QAM	55990	3625	6.79	13	PASS
16QAM	56640	3690	6.53	13	PASS

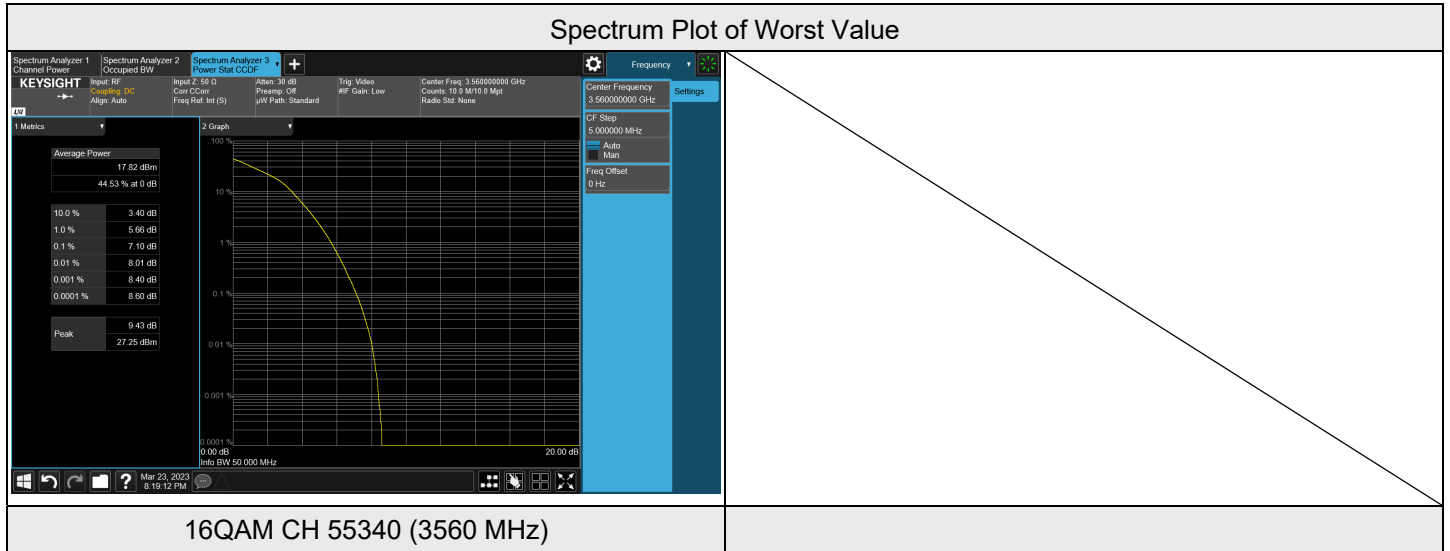

7.4 Bandwidth

Input Power:	120Vac, 60Hz	Environmental Conditions:	22°C, 72% RH	Tested By:	James Yang
--------------	--------------	---------------------------	--------------	------------	------------

7.4.1 LTE Band 48

LTE Band 48, Channel Bandwidth: 5 MHz

Modulation	Channel	Frequency (MHz)	Occupied Bandwidth (MHz)	26 dB Bandwidth (MHz)
QPSK	55265	3552.5	4.476	5.317
QPSK	55990	3625	4.480	5.086
QPSK	56715	3697.5	4.472	4.993
16QAM	55265	3552.5	4.479	5.253
16QAM	55990	3625	4.473	5.119
16QAM	56715	3697.5	4.476	5.162

Spectrum Plot of Worst Value

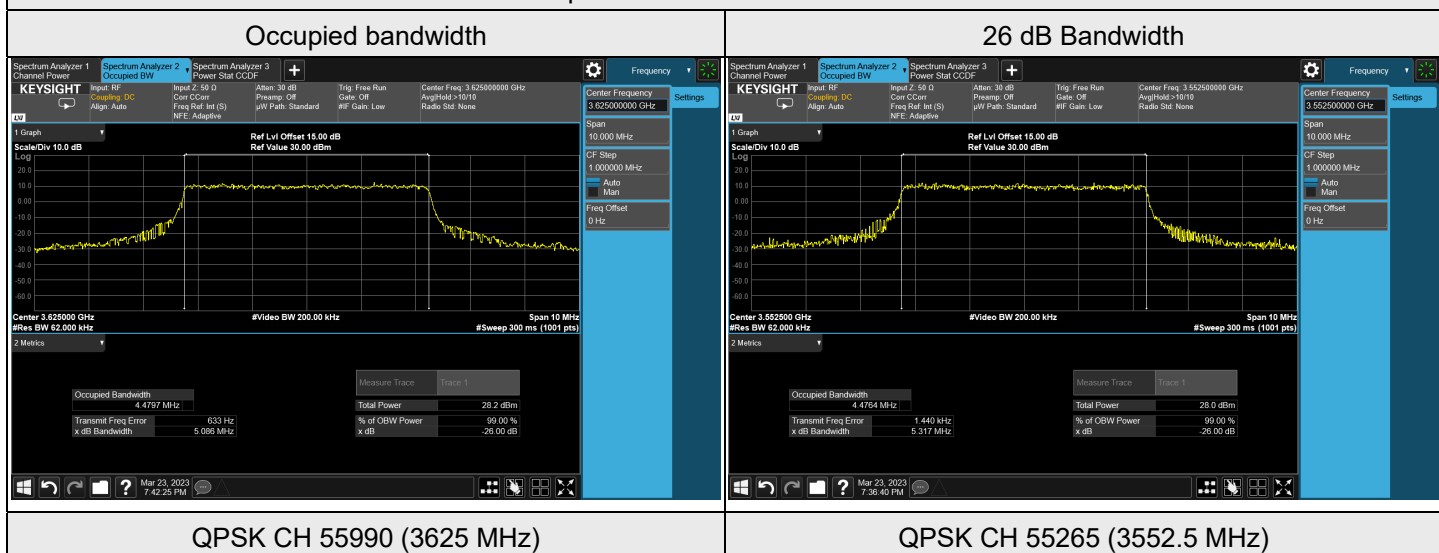



LTE Band 48, Channel Bandwidth: 10 MHz

Modulation	Channel	Frequency (MHz)	Occupied Bandwidth (MHz)	26 dB Bandwidth (MHz)
QPSK	55290	3555	8.928	9.921
QPSK	55990	3625	8.923	9.960
QPSK	56690	3695	8.922	9.974
16QAM	55290	3555	8.920	9.772
16QAM	55990	3625	8.913	9.769
16QAM	56690	3695	8.911	9.810

Spectrum Plot of Worst Value

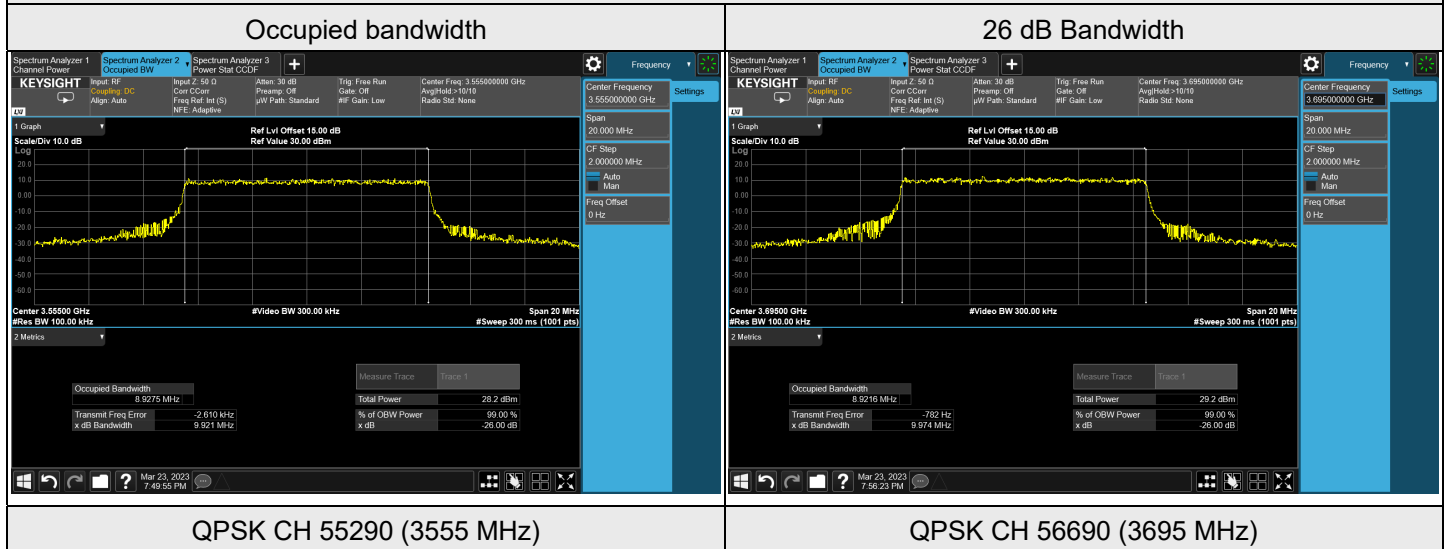



LTE Band 48, Channel Bandwidth: 15 MHz

Modulation	Channel	Frequency (MHz)	Occupied Bandwidth (MHz)	26 dB Bandwidth (MHz)
QPSK	55315	3557.5	13.428	16.570
QPSK	55990	3625	13.403	16.150
QPSK	56665	3692.5	13.416	16.140
16QAM	55315	3557.5	13.414	16.620
16QAM	55990	3625	13.425	16.610
16QAM	56665	3692.5	13.422	16.560

Spectrum Plot of Worst Value

