

Description: 2.4-2.4835GHz Ceramic SMT antenna, 4x6.25mm keep out area

Series: Chip Antenna

PART NUMBER: W3008C

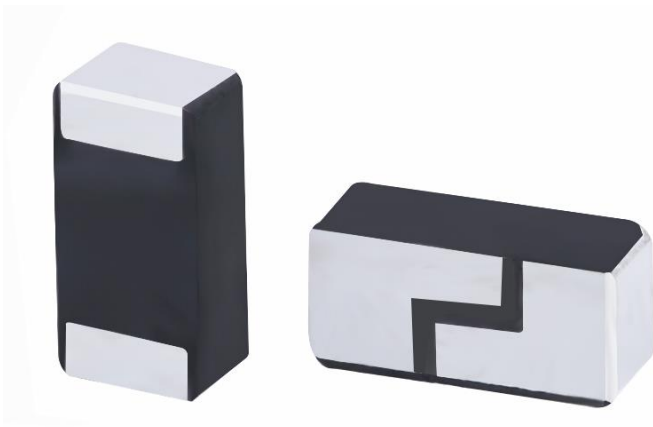

### Features:

- 2400-2483.5MHz
- Size: 3.2 x 1.6 x 1.1mm
- Efficiency: 68 %
- Gain: 1.3 dBi
- Polarization: Linear
- Power Handling: 5W
- RoHS Compliant
- Moisture Sensitivity Level MSL1

### Applications:

- Bluetooth, BLE, Zigbee, WiFi
- 2.4GHz ISM band radios

All dimensions are in mm / inches

Issue: 1946

In the effort to improve our products, we reserve the right to make changes judged to be necessary.

CONFIDENTIAL AND PROPRIETARY INFORMATION

This document contains confidential and proprietary information of Pulse Electronics, Inc. (Pulse) and is protected by copyright, trade secret and other state and federal laws. Its receipt or possession does not convey any rights to reproduce, disclose its contents, or to manufacture, use or sell anything it may describe. Reproduction, disclosure or use without specific written authorization of Pulse is strictly forbidden.

For more information:

Pulse Worldwide Headquarters  
15255 Innovation Drive #100  
San Diego, CA 92128  
USA  
Tel: 1-858-674-8100

Pulse/Larsen Antennas  
18110 SE 34<sup>th</sup> St Bldg 2 Suite 250  
Vancouver, WA 98683  
USA  
Tel: 1-360-944-7551

Europe Headquarters  
Pulse GmbH & Do, KG  
Zeppelinstrasse 15  
Herrenberg, Germany  
Tel: 49 7032 7806 0

Pulse (Suzhou) Wireless Products Co, Inc.  
99 Huo Ju Road(#29 Bldg,4<sup>th</sup> Phase  
Suzhou New District  
Jiangsu Province, Suzhou 215009 PR China  
Tel: 86 512 6807 9998



Description: **2.4-2.4835GHz Ceramic SMT antenna, 4x6.25mm keep out area**

Series: **Chip Antenna**

**PART NUMBER: W3008C**

### ELECTRICAL SPECIFICATIONS

Frequency	2400-2483.5MHz
Nominal Impedance	50 Ω
Return Loss	-8dB
Radiation Pattern	Omni
Gain	1.3dBi
Efficiency	68%
Polarization	Linear
Power Withstanding	5W

### MECHANICAL SPECIFICATIONS

Weight	0.03 g
Overall Length	3.2 [0.126] MM [INCHES]
Over all width	1.6 [0.063] MM [INCHES]
Over all thickness	1.1 [0.043] MM [INCHES]
MSL (Moisture Sensitivity Level)	1

### ENVIRONMENTAL SPECIFICATIONS

Operating Temperature	-40~+85° C
Storage Temperature	-40~+85° C
RoHS Compliant	Yes

(\* ) All RF parameters measured on 80\*37mm PCB with 4\*6.25mm clearance in free space. No matching component used.

Issue: 1946

In the effort to improve our products, we reserve the right to make changes judged to be necessary.

CONFIDENTIAL AND PROPRIETARY INFORMATION

This document contains confidential and proprietary information of Pulse Electronics, Inc. (Pulse) and is protected by copyright, trade secret and other state and federal laws. Its receipt or possession does not convey any rights to reproduce, disclose its contents, or to manufacture, use or sell anything it may describe. Reproduction, disclosure or use without specific written authorization of Pulse is strictly forbidden.

Description: 2.4-2.4835GHz Ceramic SMT antenna, 4x6.25mm keep out area

Series: Chip Antenna

PART NUMBER: W3008C

MECHANICAL DRAWING

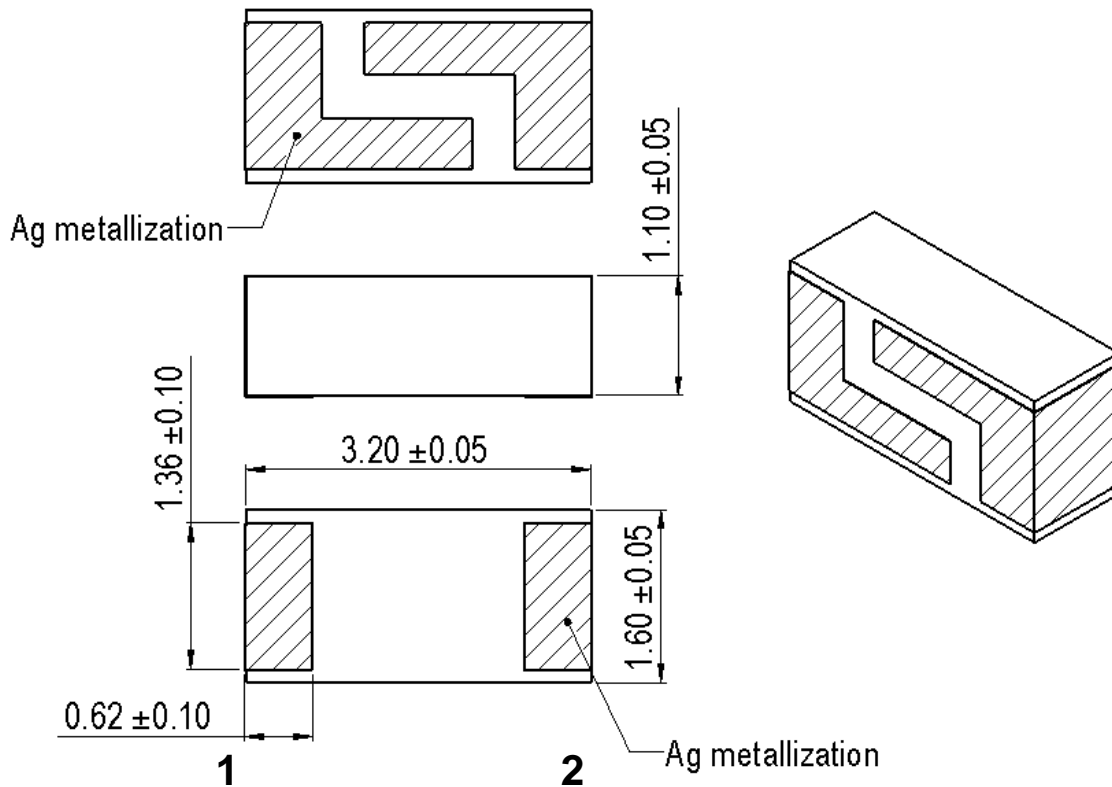

No.	Terminal Name	Terminal Dimensions
1	Feed /GND	0.62 x 1.36 mm
2	Feed /GND	0.62 x 1.36 mm
Antenna is symmetrical, either one of pads 1 or 2 can be used as feed terminal		

Note: This type of antenna is called loaded PIFA. One pad (on the bottom of the ceramic chip antenna) that feedline and GND are connected is a basic PIFA antenna structure. And, another pad on the other side that only GND is connected is for capacitive loading. Loaded capacitive value is optimized by the gap distance between two pads on the top surface. In PIFA, there is short mechanism usually in proximity to feed. This RF shorting affects impedance and current distribution mechanism of antenna. The actual antenna top face can seem to be mirrored, however it can be used same as the non-mirrored version. Please follow the design recommendation specified in this data sheet for either case.

Description: 2.4-2.4835GHz Ceramic SMT antenna, 4x6.25mm keep out area

Series: Chip Antenna

PART NUMBER: W3008C

MECHANICAL DRAWING AND TERMINAL CONFIGURATION

*Ground cleared under antenna, clearance area 4 mm x 6.25mm*

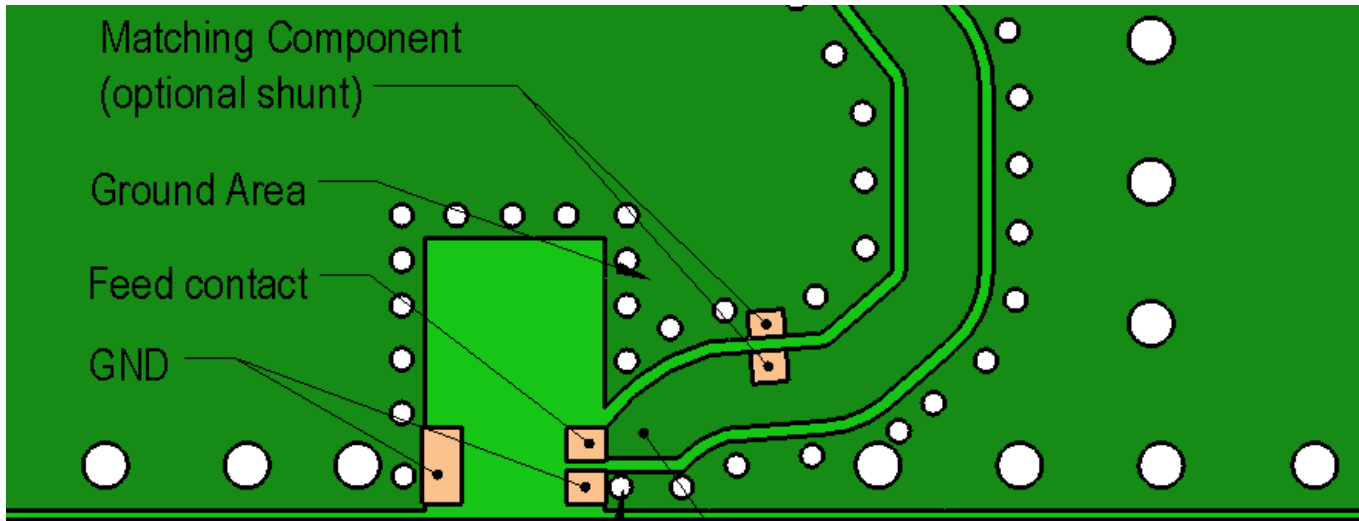

Ground Via Hole  
Ground area should be surround with ground via holes

Feed line 50Ohm  
Any type of 50 Ohm feed line can be used. inner layers on feed line area need to designed to give 50 Ohm characteristics to feed line.

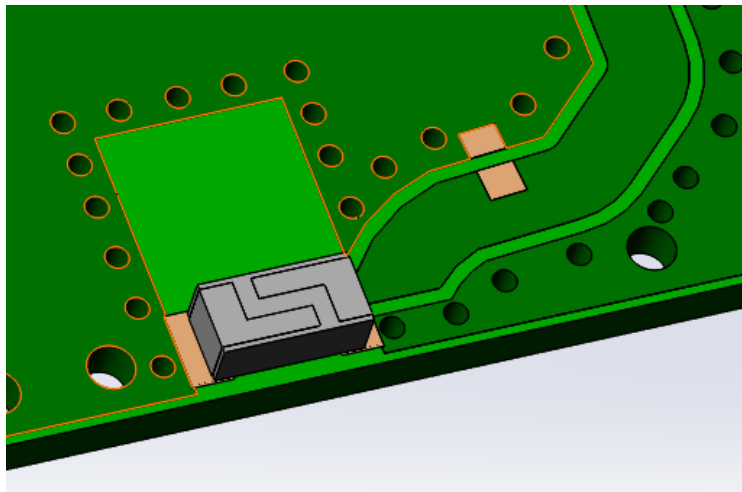

Issue: 1946

In the effort to improve our products, we reserve the right to make changes judged to be necessary.

CONFIDENTIAL AND PROPRIETARY INFORMATION

This document contains confidential and proprietary information of Pulse Electronics, Inc. (Pulse) and is protected by copyright, trade secret and other state and federal laws. Its receipt or possession does not convey any rights to reproduce, disclose its contents, or to manufacture, use or sell anything it may describe. Reproduction, disclosure or use without specific written authorization of Pulse is strictly forbidden.

Description: 2.4-2.4835GHz Ceramic SMT antenna, 4x6.25mm keep out area

Series: Chip Antenna

PART NUMBER: W3008C

**MECHANICAL DRAWING AND TERMINAL CONFIGURATION**

*Recommended Antenna Pad Dimensions on PCB Layout (top surface)  
Ground cleared under antenna, clearance area 4 mm x 6.25 mm*

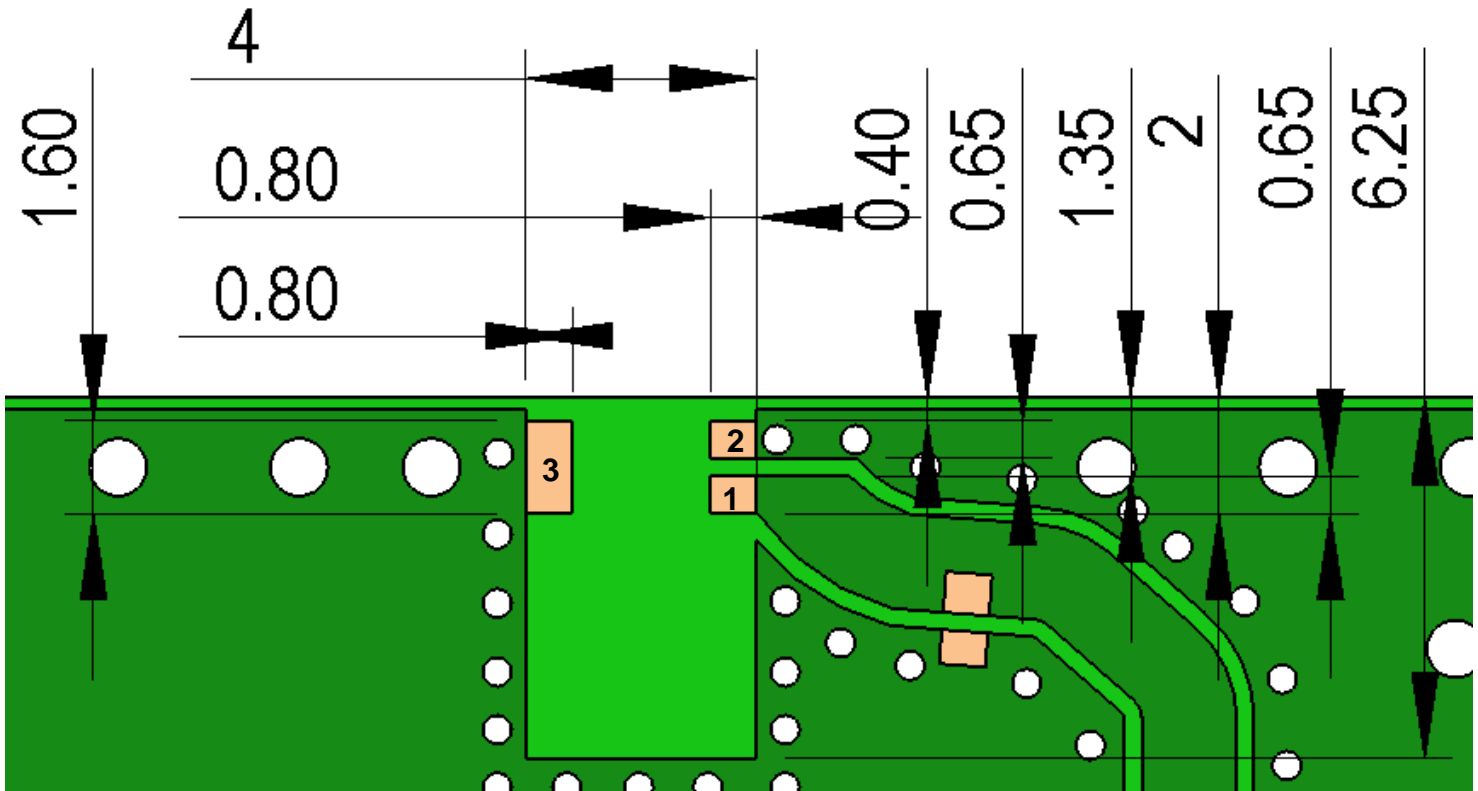

PCB contact pads		
No.	Terminal Name	Terminal Dimensions
1	Feed	0,80 x 0,65 mm
2	GND	0,80 x 0,65 mm
3	GND	0,80 x 1,60 mm

Description: 2.4-2.4835GHz Ceramic SMT antenna, 4x6.25mm keep out area

Series: Chip Antenna

PART NUMBER: W3008C

MECHANICAL DRAWING AND TERMINAL CONFIGURATION

*Recommended Antenna Pad Dimensions on PCB Layout (bottom surface)  
Ground cleared under antenna, clearance area 4 mm x 6.25 mm*

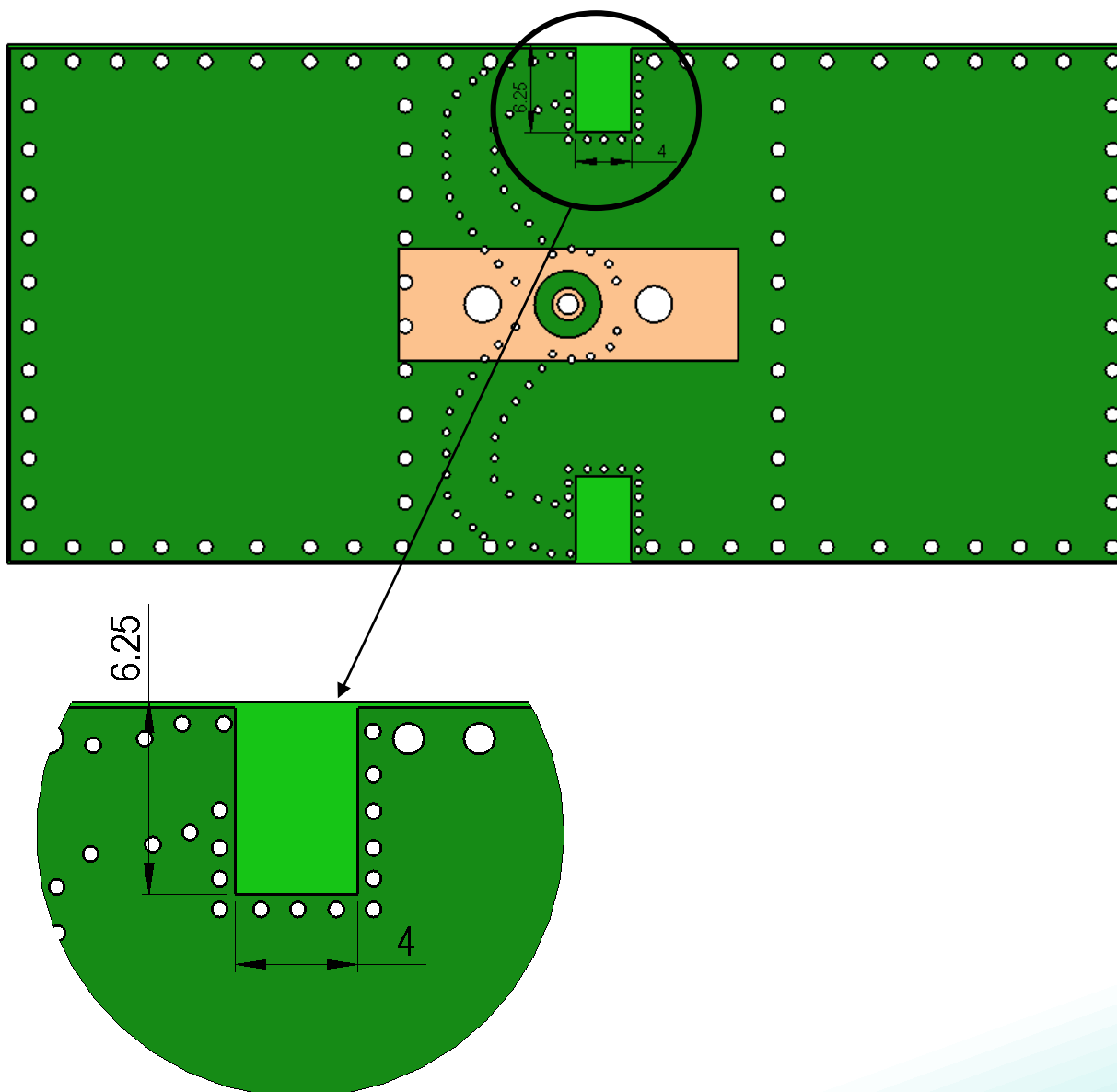

Issue: 1946

In the effort to improve our products, we reserve the right to make changes judged to be necessary.

CONFIDENTIAL AND PROPRIETARY INFORMATION

This document contains confidential and proprietary information of Pulse Electronics, Inc. (Pulse) and is protected by copyright, trade secret and other state and federal laws. Its receipt or possession does not convey any rights to reproduce, disclose its contents, or to manufacture, use or sell anything it may describe. Reproduction, disclosure or use without specific written authorization of Pulse is strictly forbidden.

Description: 2.4-2.4835GHz Ceramic SMT antenna, 4x6.25mm keep out area

Series: Chip Antenna

PART NUMBER: W3008C

MECHANICAL DRAWING AND TERMINAL CONFIGURATION

*Recommended test board layout for electrical characteristic measurement, test board outline size 80 x 37mm*

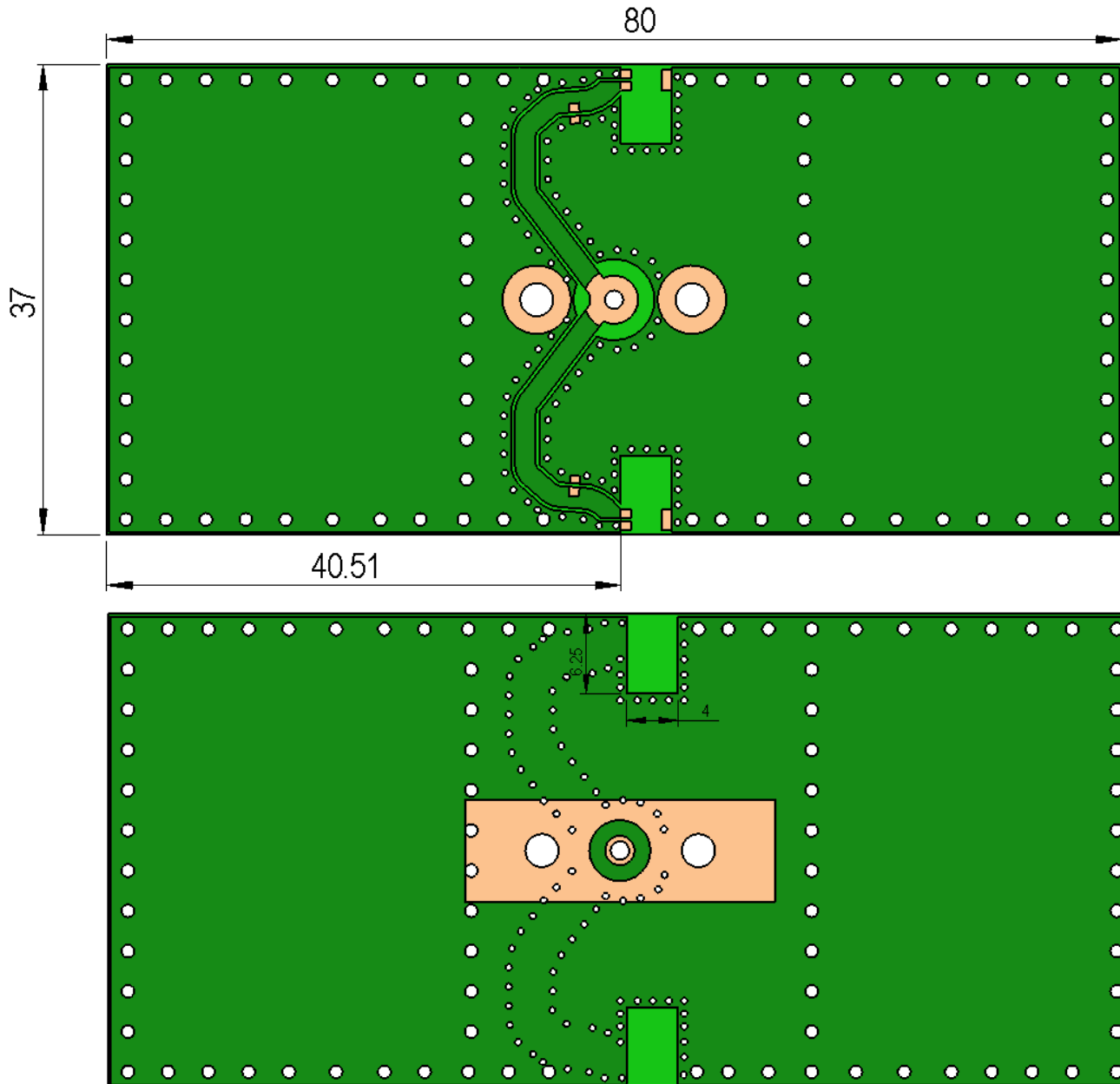

Issue: 1946

In the effort to improve our products, we reserve the right to make changes judged to be necessary.

CONFIDENTIAL AND PROPRIETARY INFORMATION

This document contains confidential and proprietary information of Pulse Electronics, Inc. (Pulse) and is protected by copyright, trade secret and other state and federal laws. Its receipt or possession does not convey any rights to reproduce, disclose its contents, or to manufacture, use or sell anything it may describe. Reproduction, disclosure or use without specific written authorization of Pulse is strictly forbidden.

Description: 2.4-2.4835GHz Ceramic SMT antenna, 4x6.25mm keep out area

Series: Chip Antenna

PART NUMBER: W3008C

CHARTS

Return loss

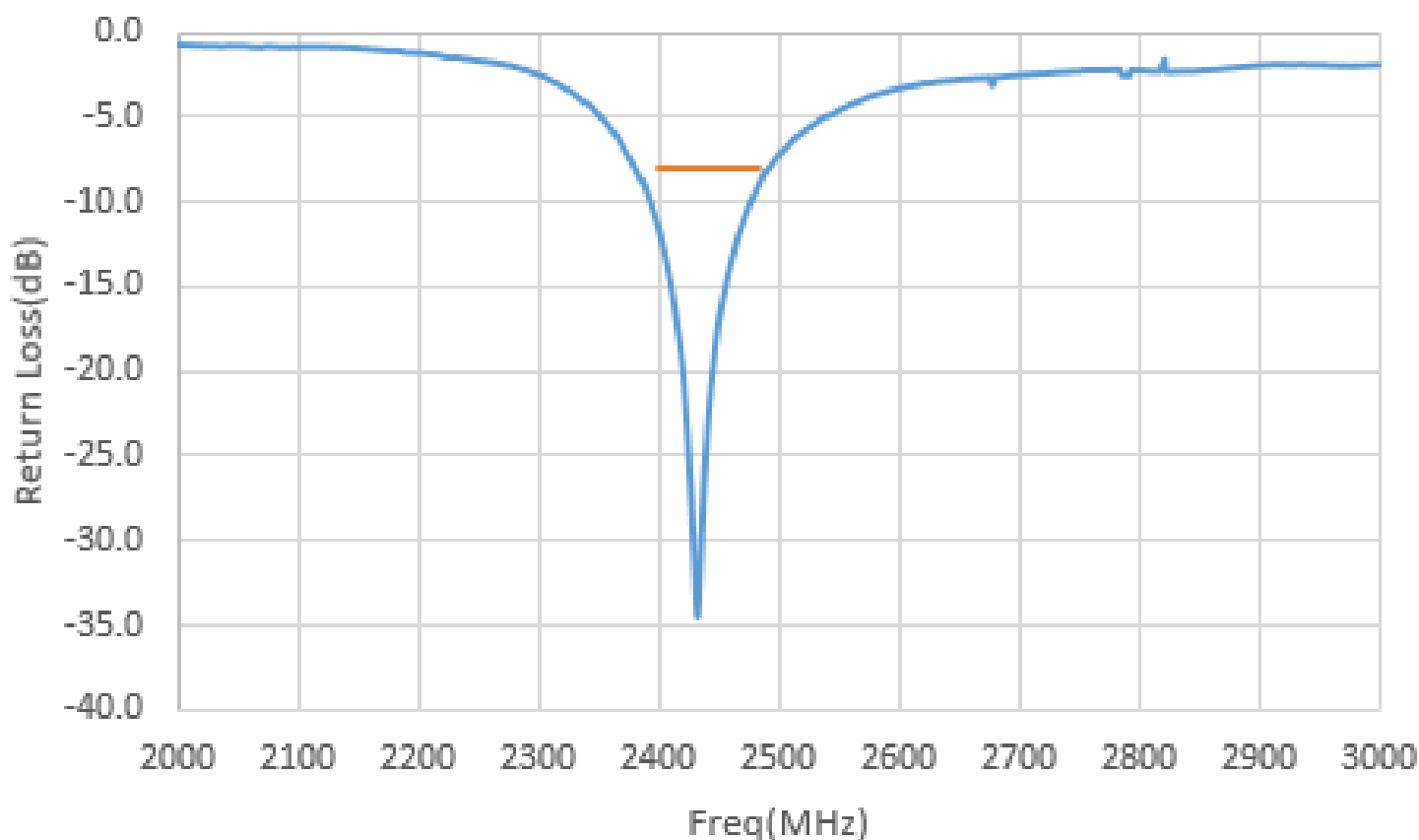

(\* All RF parameters measured on 80\*37mm PCB with 4\*6.25mm clearance in free space. No matching component used.

Issue: 1946

In the effort to improve our products, we reserve the right to make changes judged to be necessary.

CONFIDENTIAL AND PROPRIETARY INFORMATION

This document contains confidential and proprietary information of Pulse Electronics, Inc. (Pulse) and is protected by copyright, trade secret and other state and federal laws. Its receipt or possession does not convey any rights to reproduce, disclose its contents, or to manufacture, use or sell anything it may describe. Reproduction, disclosure or use without specific written authorization of Pulse is strictly forbidden.



Description: 2.4-2.4835GHz Ceramic SMT antenna, 4x6.25mm keep out area

Series: Chip Antenna

PART NUMBER: W3008C

CHARTS

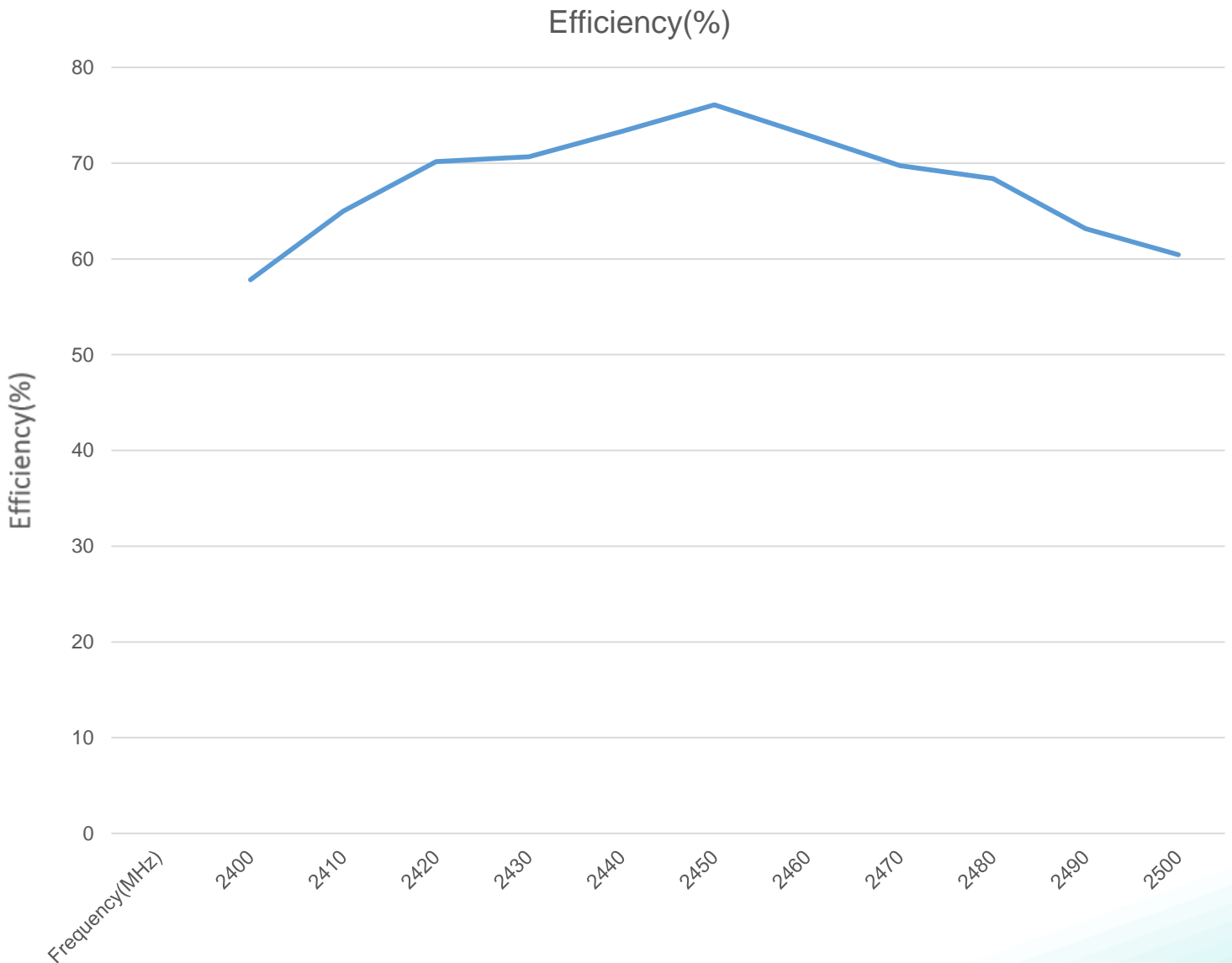

(\*) All RF parameters measured on 80\*37mm PCB with 4\*6.25mm clearance in free space. No matching component used.

Issue: 1946

In the effort to improve our products, we reserve the right to make changes judged to be necessary.

CONFIDENTIAL AND PROPRIETARY INFORMATION

This document contains confidential and proprietary information of Pulse Electronics, Inc. (Pulse) and is protected by copyright, trade secret and other state and federal laws. Its receipt or possession does not convey any rights to reproduce, disclose its contents, or to manufacture, use or sell anything it may describe. Reproduction, disclosure or use without specific written authorization of Pulse is strictly forbidden.

Description: 2.4-2.4835GHz Ceramic SMT antenna, 4x6.25mm keep out area

Series: Chip Antenna

PART NUMBER: W3008C

CHARTS

Peak Gain(dBi)

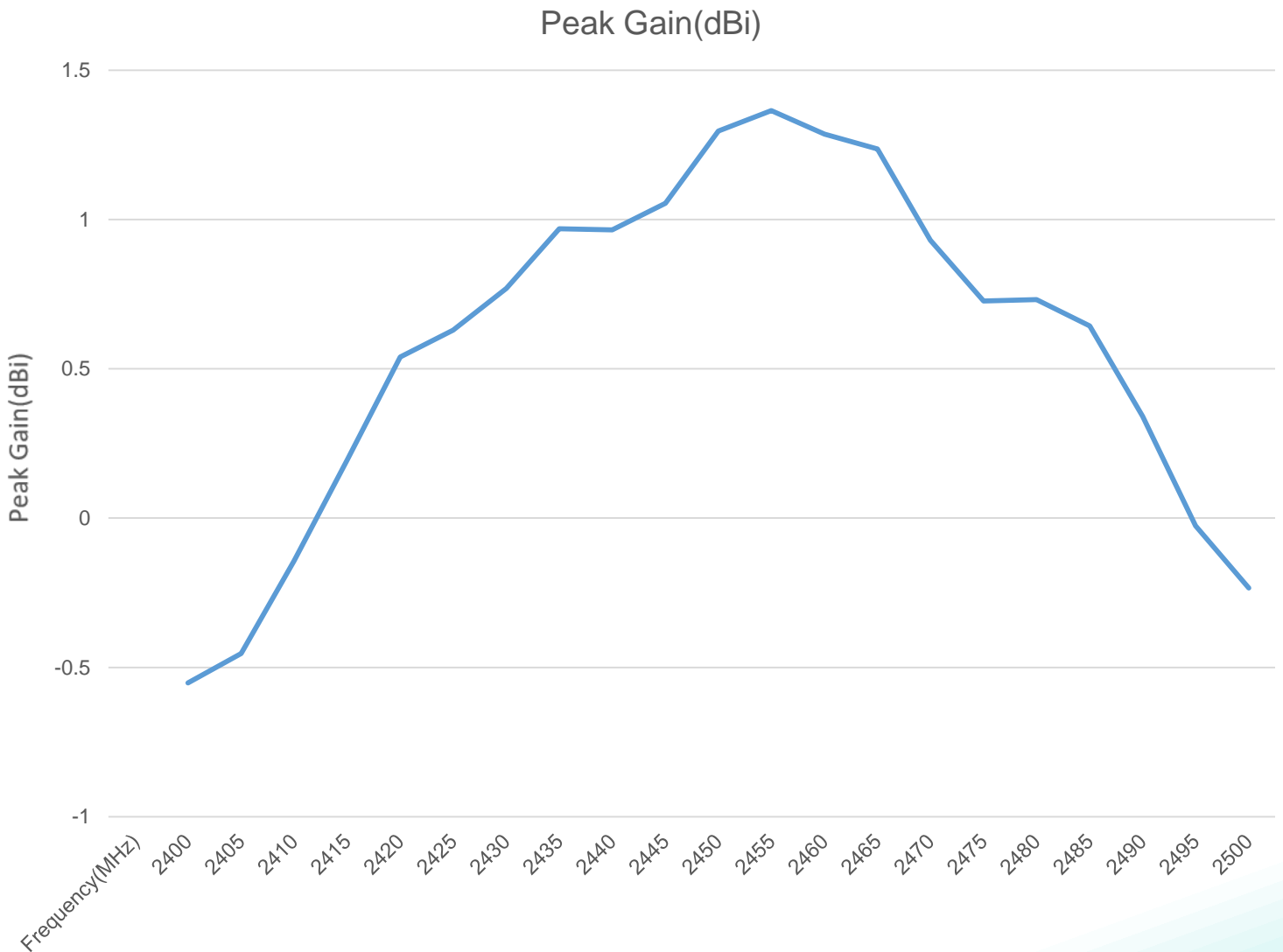

(\* ) All RF parameters measured on 80\*37mm PCB with 4\*6.25mm clearance in free space. No matching component used.

Issue: 1946

In the effort to improve our products, we reserve the right to make changes judged to be necessary.

CONFIDENTIAL AND PROPRIETARY INFORMATION

This document contains confidential and proprietary information of Pulse Electronics, Inc. (Pulse) and is protected by copyright, trade secret and other state and federal laws. Its receipt or possession does not convey any rights to reproduce, disclose its contents, or to manufacture, use or sell anything it may describe. Reproduction, disclosure or use without specific written authorization of Pulse is strictly forbidden.

Description: 2.4-2.4835GHz Ceramic SMT antenna, 4x6.25mm keep out area

Series: Chip Antenna

PART NUMBER: W3008C

CHARTS

Free Space Radiation Pattern

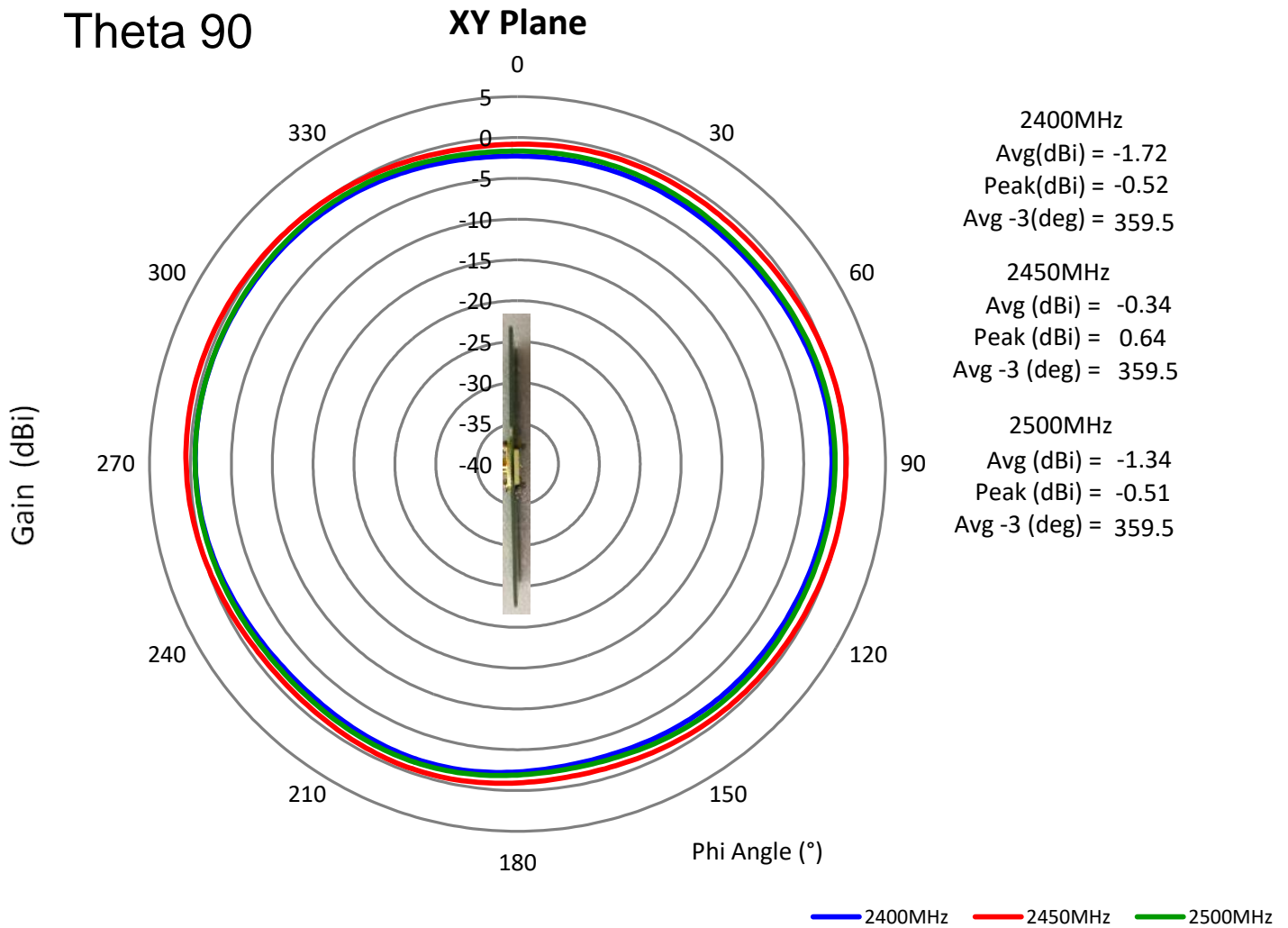

(\* All RF parameters measured on 80\*37mm PCB with 4\*6.25mm clearance in free space. No matching component used.

Issue: 1946

In the effort to improve our products, we reserve the right to make changes judged to be necessary.

CONFIDENTIAL AND PROPRIETARY INFORMATION

This document contains confidential and proprietary information of Pulse Electronics, Inc. (Pulse) and is protected by copyright, trade secret and other state and federal laws. Its receipt or possession does not convey any rights to reproduce, disclose its contents, or to manufacture, use or sell anything it may describe. Reproduction, disclosure or use without specific written authorization of Pulse is strictly forbidden.

Description: 2.4-2.4835GHz Ceramic SMT antenna, 4x6.25mm keep out area

Series: Chip Antenna

PART NUMBER: W3008C

CHARTS

Free Space Radiation Pattern

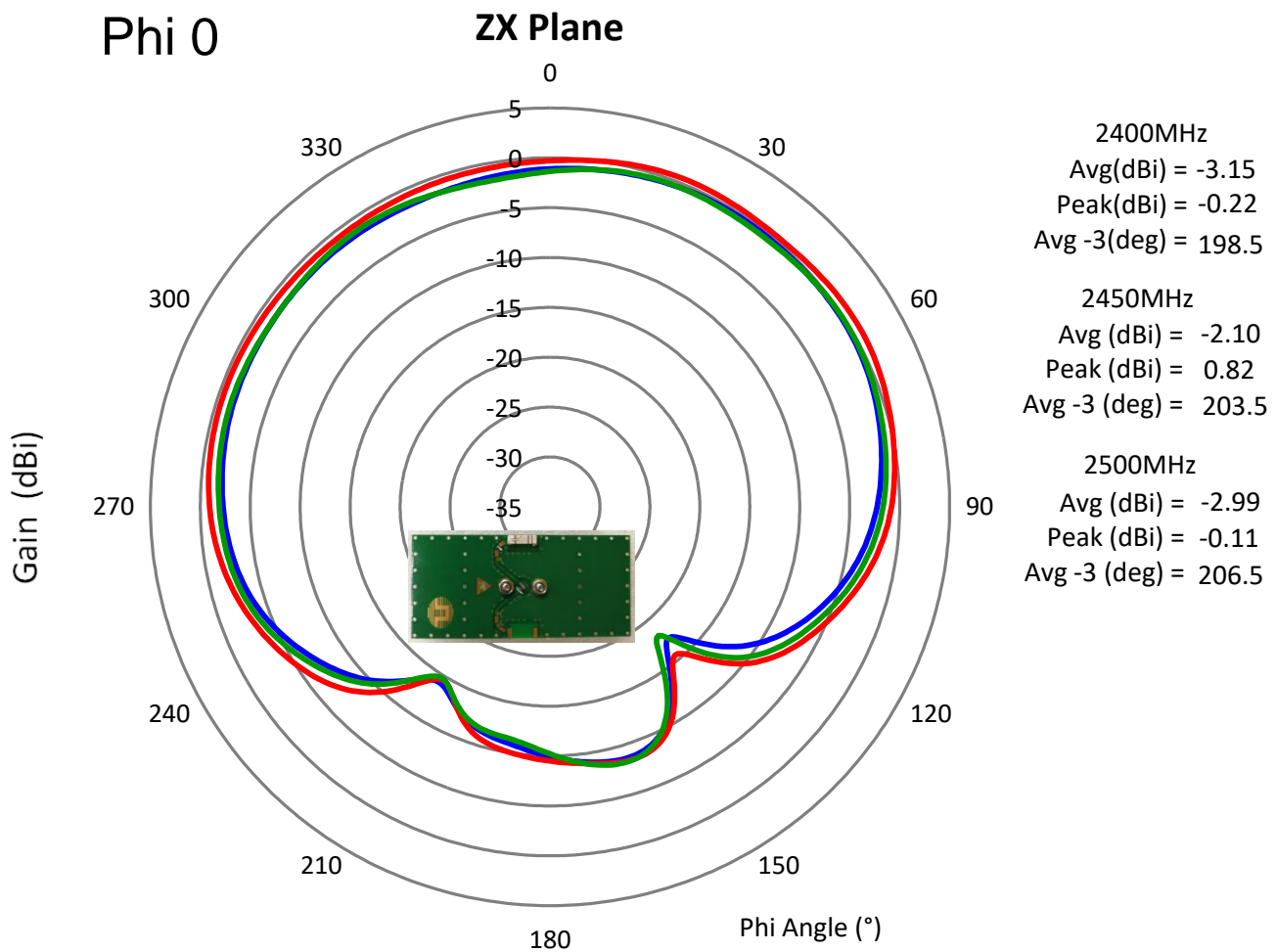

(\* All RF parameters measured on 80\*37mm PCB with 4\*6.25mm clearance in free space. No matching component used.

Issue: 1946

In the effort to improve our products, we reserve the right to make changes judged to be necessary.

CONFIDENTIAL AND PROPRIETARY INFORMATION

This document contains confidential and proprietary information of Pulse Electronics, Inc. (Pulse) and is protected by copyright, trade secret and other state and federal laws. Its receipt or possession does not convey any rights to reproduce, disclose its contents, or to manufacture, use or sell anything it may describe. Reproduction, disclosure or use without specific written authorization of Pulse is strictly forbidden.

Description: 2.4-2.4835GHz Ceramic SMT antenna, 4x6.25mm keep out area

Series: Chip Antenna

PART NUMBER: W3008C

CHARTS

Free Space Radiation Pattern

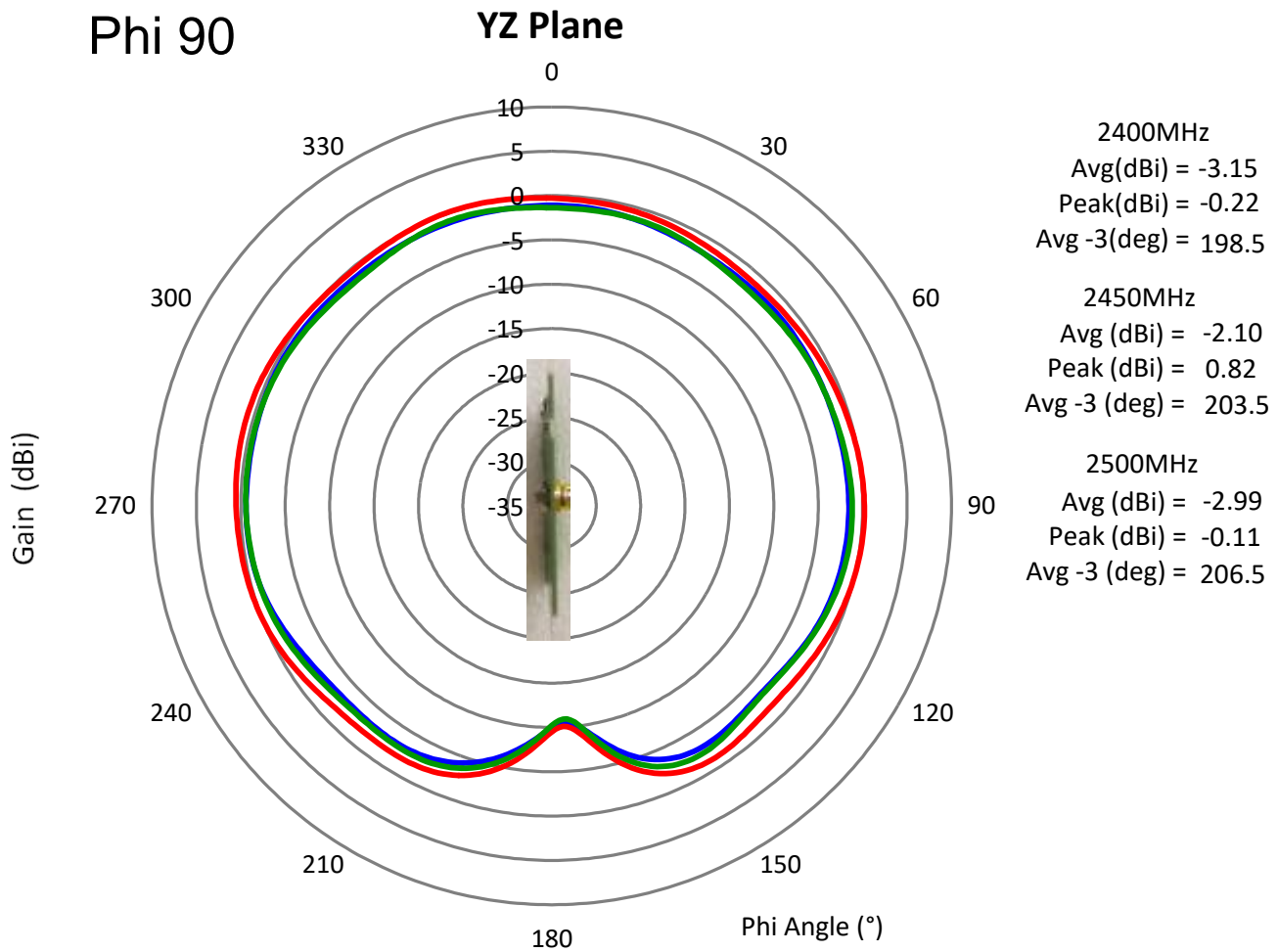

(\* All RF parameters measured on 80\*37mm PCB with 4\*6.25mm clearance in free space. No matching component used.

Issue: 1946

In the effort to improve our products, we reserve the right to make changes judged to be necessary.

CONFIDENTIAL AND PROPRIETARY INFORMATION

This document contains confidential and proprietary information of Pulse Electronics, Inc. (Pulse) and is protected by copyright, trade secret and other state and federal laws. Its receipt or possession does not convey any rights to reproduce, disclose its contents, or to manufacture, use or sell anything it may describe. Reproduction, disclosure or use without specific written authorization of Pulse is strictly forbidden.

**Description: 2.4-2.4835GHz Ceramic SMT antenna, 4x6.25mm keep out area**

**Series: Chip Antenna**

**PART NUMBER: W3008C**

**Recommendation for reflow soldering process**

Printing stencil thickness 0,15 - 0,25 mm is recommended for the solder paste. The maximum soldering temperature should not exceed 260°C. The temperature profile recommendations for reflow soldering process is presented in the Figures 1 and 2. The reflow profile

presented in figure 1 describes minimum reflow temperatures. The reflow profile presented in figure 2 describes maximum reflow temperatures. located at the center of the coverage area.

	Method of heat transfer	Controlled hot air convection
1	Average temperature gradient in preheating	2.5 °C/s
2	Soak time	2-3 minutes
3	Max temperature gradient in reflow	3 °C/s
4	Time above 217 °C	Max 30 sec
5	Peak temperature in reflow	230 °C for 10 seconds
6	Temperature gradient in cooling	Max -5 °C/s

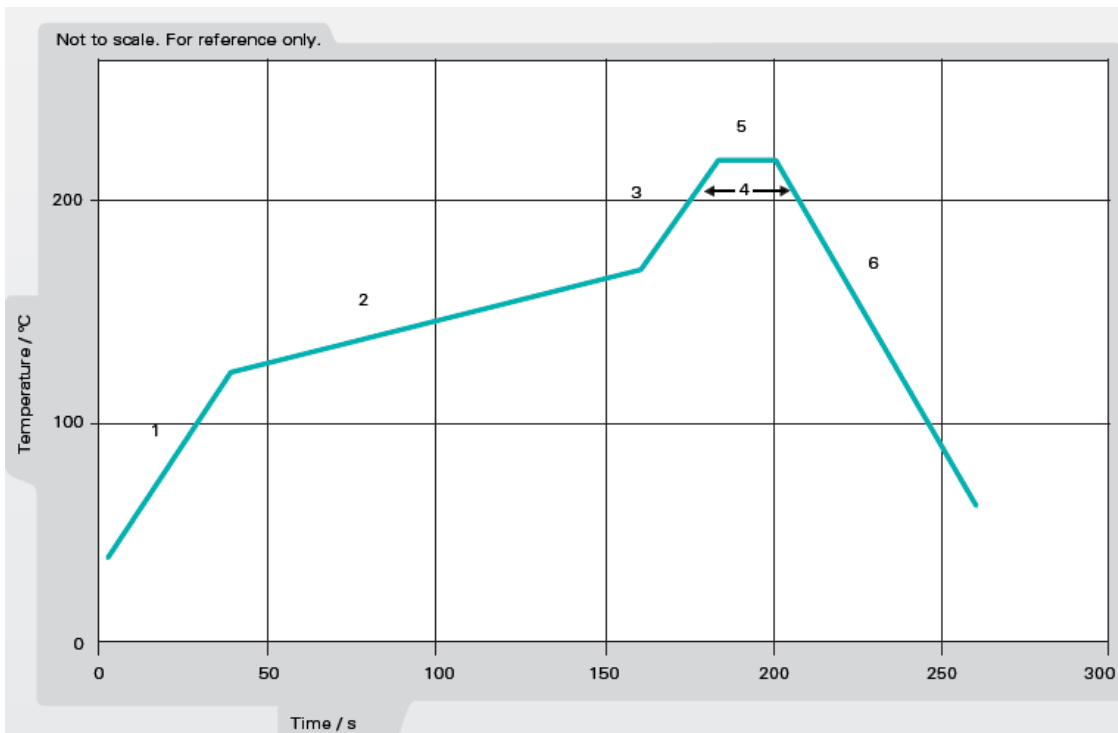

Figure 1. Minimum temperature profile recommendation for reflow soldering process

Description: 2.4-2.4835GHz Ceramic SMT antenna, 4x6.25mm keep out area

Series: Chip Antenna

PART NUMBER: W3008C

Recommendation for reflow soldering process

	Method of heat transfer	Controlled hot air convection
1	Average temperature gradient in preheating	2.5 °C/s
2	Soak time	2-3 minutes
3	Max temperature gradient in reflow	3 °C/s
4	Time above 217 °C	Max 60 sec
5	Time above 230 °C	Max 50 sec
6	Time above 250 °C	Max 10 sec
7	Peak temperature in reflow	260 °C for 5 seconds
8	Temperature gradient in cooling	Max -5 °C/s

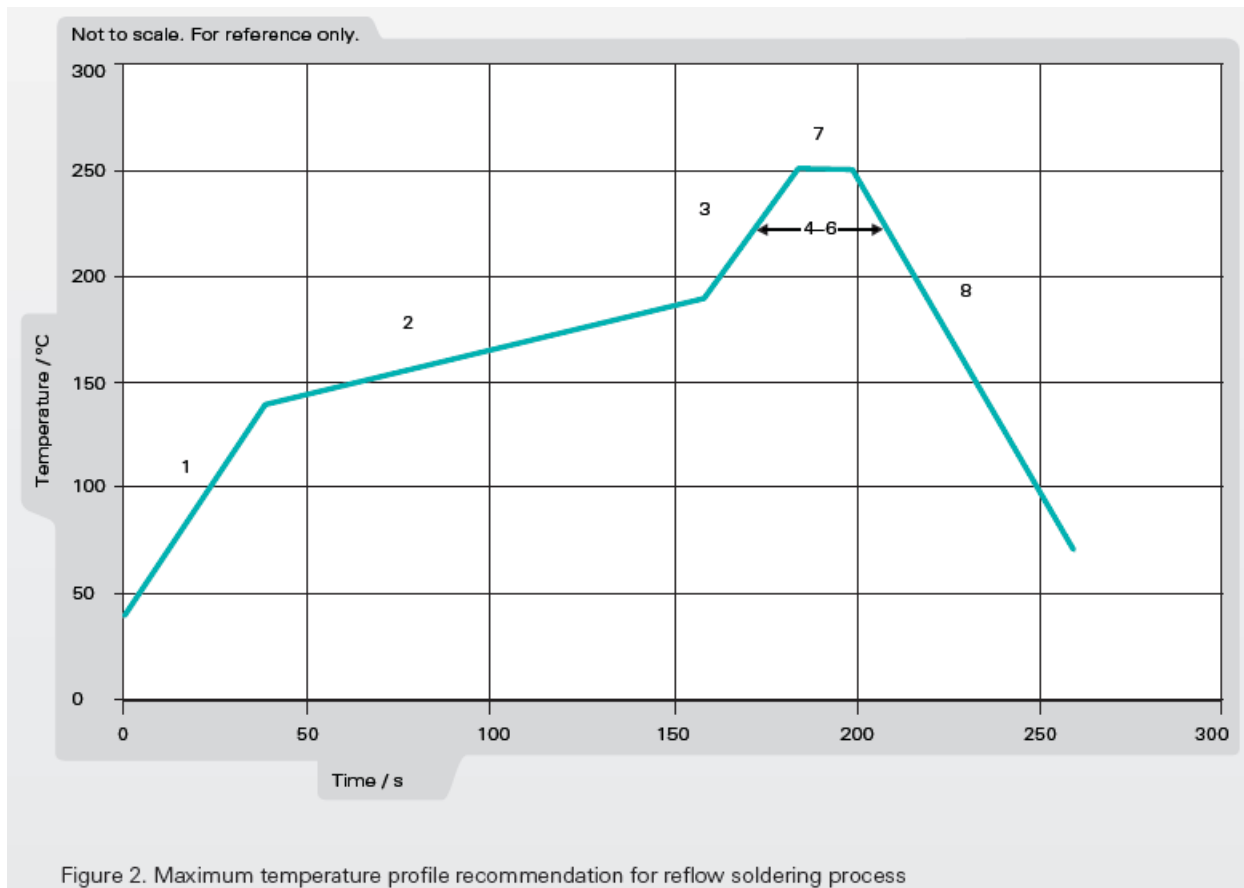

Issue: 1946

In the effort to improve our products, we reserve the right to make changes judged to be necessary.

CONFIDENTIAL AND PROPRIETARY INFORMATION

This document contains confidential and proprietary information of Pulse Electronics, Inc. (Pulse) and is protected by copyright, trade secret and other state and federal laws. Its receipt or possession does not convey any rights to reproduce, disclose its contents, or to manufacture, use or sell anything it may describe. Reproduction, disclosure or use without specific written authorization of Pulse is strictly forbidden.

Description: 2.4-2.4835GHz Ceramic SMT antenna, 4x6.25mm keep out area

Series: Chip Antenna

PART NUMBER: W3008C

**PACKAGING-1**

3000pcs antennas per 7" reel  
 5pcs 7" reel per inner package box  
 2pcs inner box per out box  
 Total 30000pcs antenna per out box  
 Out box size: 390mmx215mmx165mm

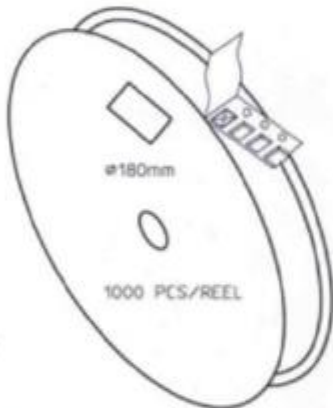
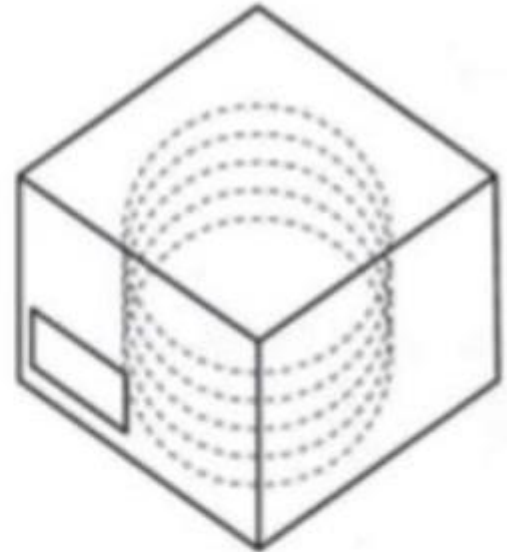

<p><b>NOT MOISTURE SENSITIVE</b></p>	<p><b>LEVEL</b></p> <div style="border: 1px solid black; padding: 5px; display: inline-block;"> <p><b>1</b></p> </div>
<p>These Devices do not require special storage conditions provided:</p> <ol style="list-style-type: none"> <li>1. They are maintained at conditions equal to or less than 30°C and 85% RH.</li> <li>2. They are solder reflowed at a peak body temperature which does not exceed 260°C.</li> </ol> <p>Note: Level 1 and body temperature defined by IPC/JEDEC J-STD-020</p>	

Issue: 1946

In the effort to improve our products, we reserve the right to make changes judged to be necessary.

CONFIDENTIAL AND PROPRIETARY INFORMATION

This document contains confidential and proprietary information of Pulse Electronics, Inc. (Pulse) and is protected by copyright, trade secret and other state and federal laws. Its receipt or possession does not convey any rights to reproduce, disclose its contents, or to manufacture, use or sell anything it may describe. Reproduction, disclosure or use without specific written authorization of Pulse is strictly forbidden.



**Description: 2.4-2.4835GHz Ceramic SMT antenna, 4x6.25mm keep out area**

**Series: Chip Antenna**

**PART NUMBER: W3008C**

**PACKAGING-2**

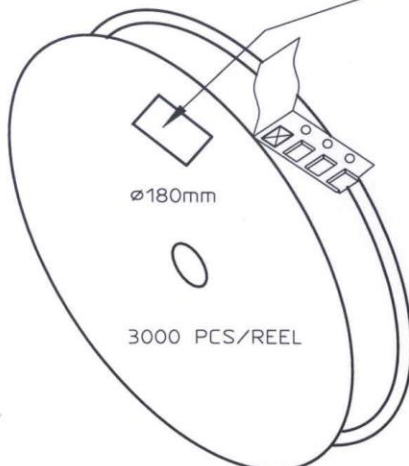

REEL LABEL INFORMATION:  
 - TRACEABILITY  
 - QUANTITY  
 - PRODUCT CODE

ø180mm  
 3000 PCS/REEL

CARRIER TAPE H85-00125  
 width=8,00 depth=1,22  
 COVER TAPE H85-00126  
 width=5,60

LENGTH OF TAPE:  
 - Leader section: min 350 mm before component section  
 - Trailer section: min 40 mm after component section.

Empty part cavities at leader and trailer section of the tape must be sealed with top cover tape.

BOX H85-00128 (182x182x132)	1 pcs
- LABEL	1 pcs/BOX
REEL H85-00127 (D180, W12)	10 pcs
- REEL LABEL	1 pcs/REEL

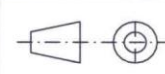
MATERIAL				
HANDLINGS				
		RATIO	DRWN 090507 PeHa H	
			DGNER	G
			CHKD	F
			APPRD	E
PRODUCT H90-OY805		APPRD BY	D	
DENOMINATION PACKING FORM			C	
			B	
			A	
VERSION		MOD/DATE/NAME		

Issue: 1946

In the effort to improve our products, we reserve the right to make changes judged to be necessary.

CONFIDENTIAL AND PROPRIETARY INFORMATION

This document contains confidential and proprietary information of Pulse Electronics, Inc. (Pulse) and is protected by copyright, trade secret and other state and federal laws. Its receipt or possession does not convey any rights to reproduce, disclose its contents, or to manufacture, use or sell anything it may describe. Reproduction, disclosure or use without specific written authorization of Pulse is strictly forbidden.

# Mouser Electronics

Authorized Distributor

Click to View Pricing, Inventory, Delivery & Lifecycle Information:

Pulse:

[W3008C](#)