

LINEAR

LINTREX C7

CATEGORY 5E CLASSIFIED OR CABLE OR

Steel
Stainless
Flexible
4
5
6
7
8
9
10
11
12

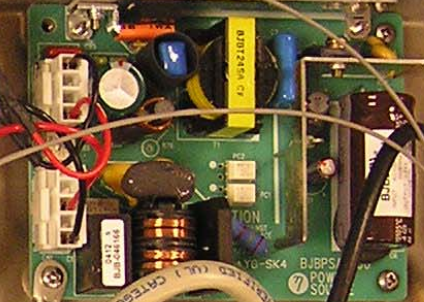
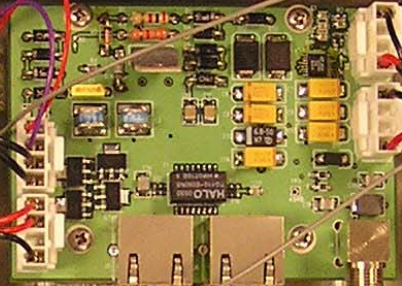
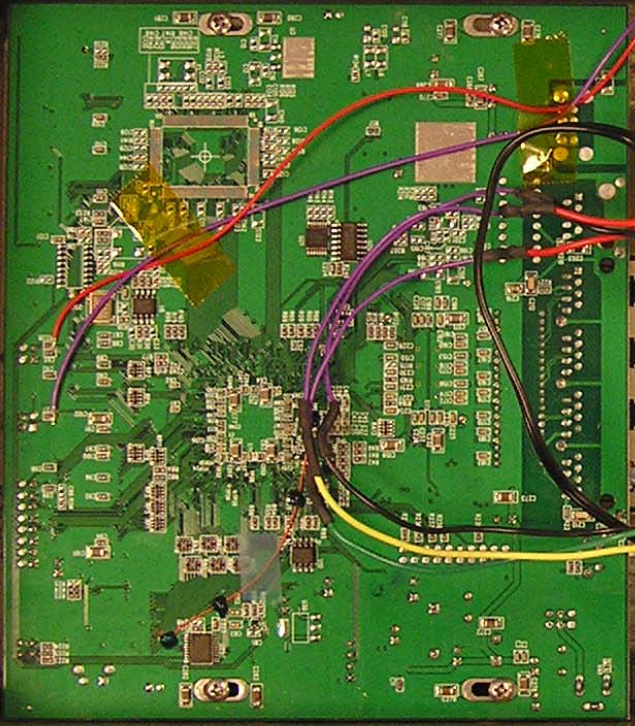
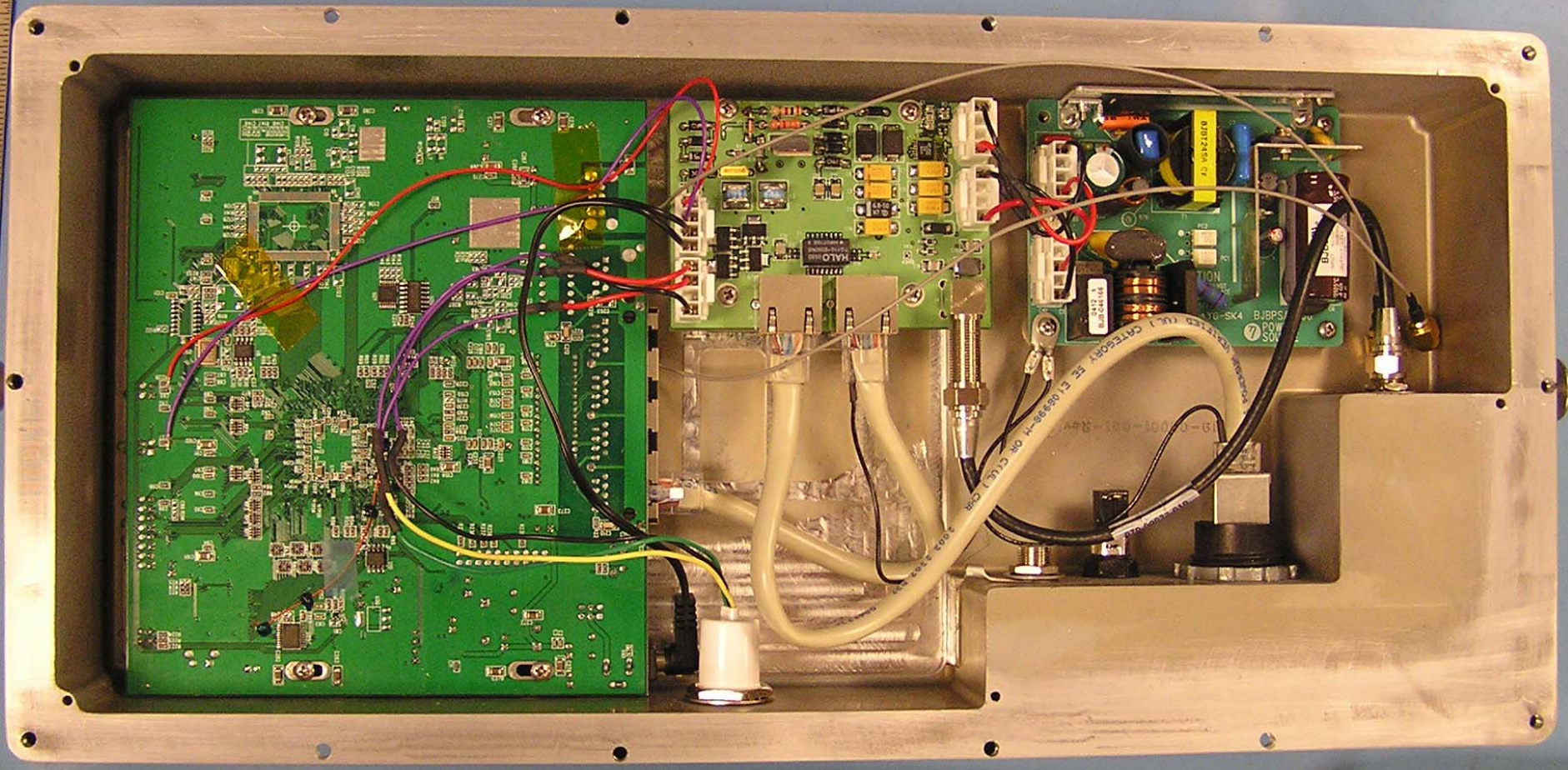

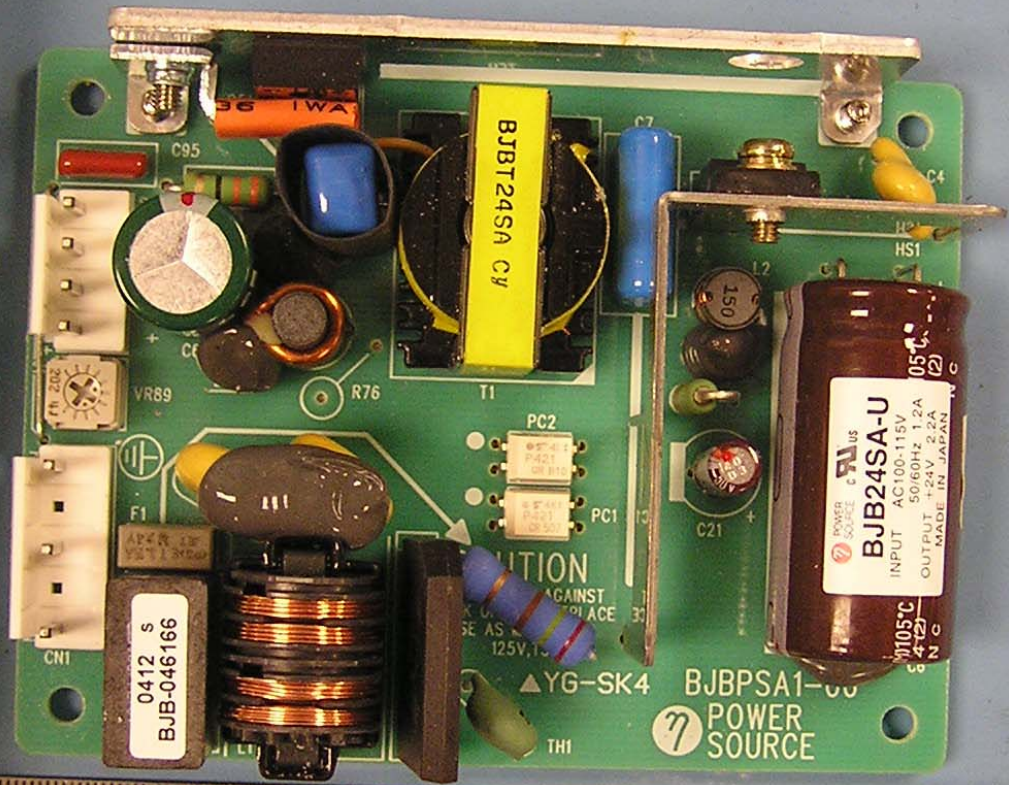

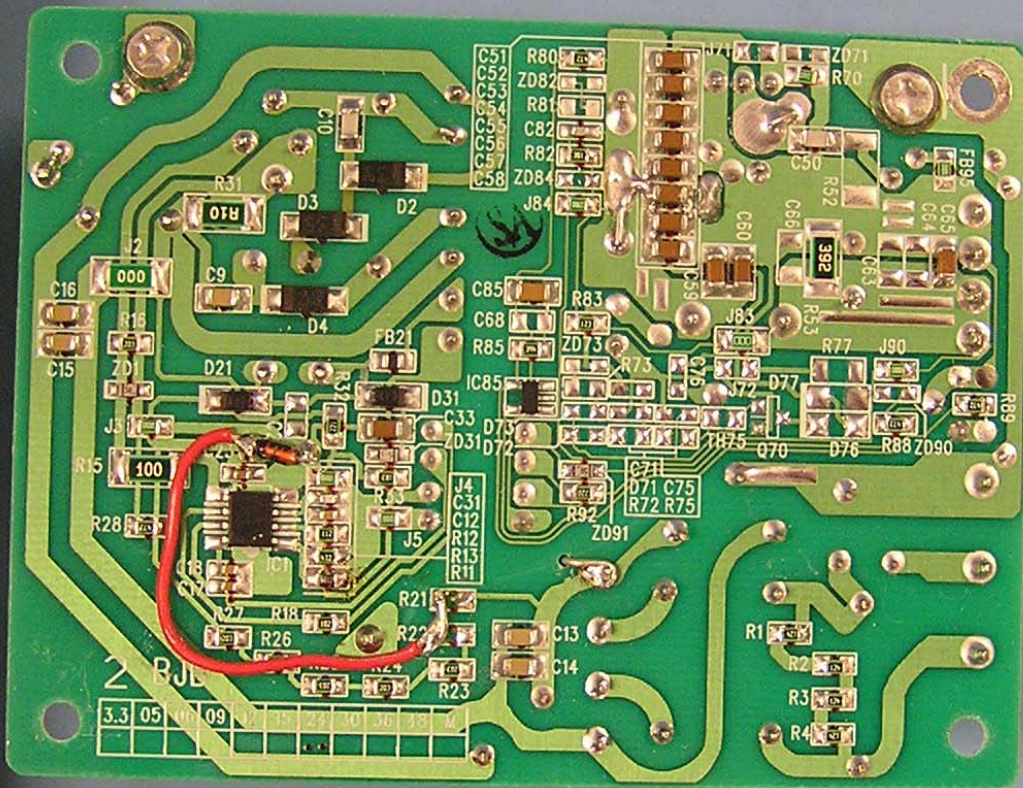

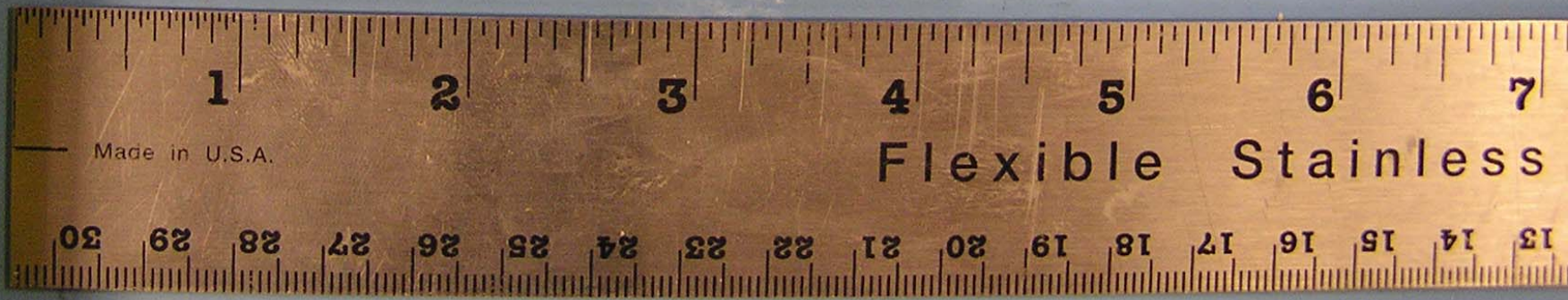
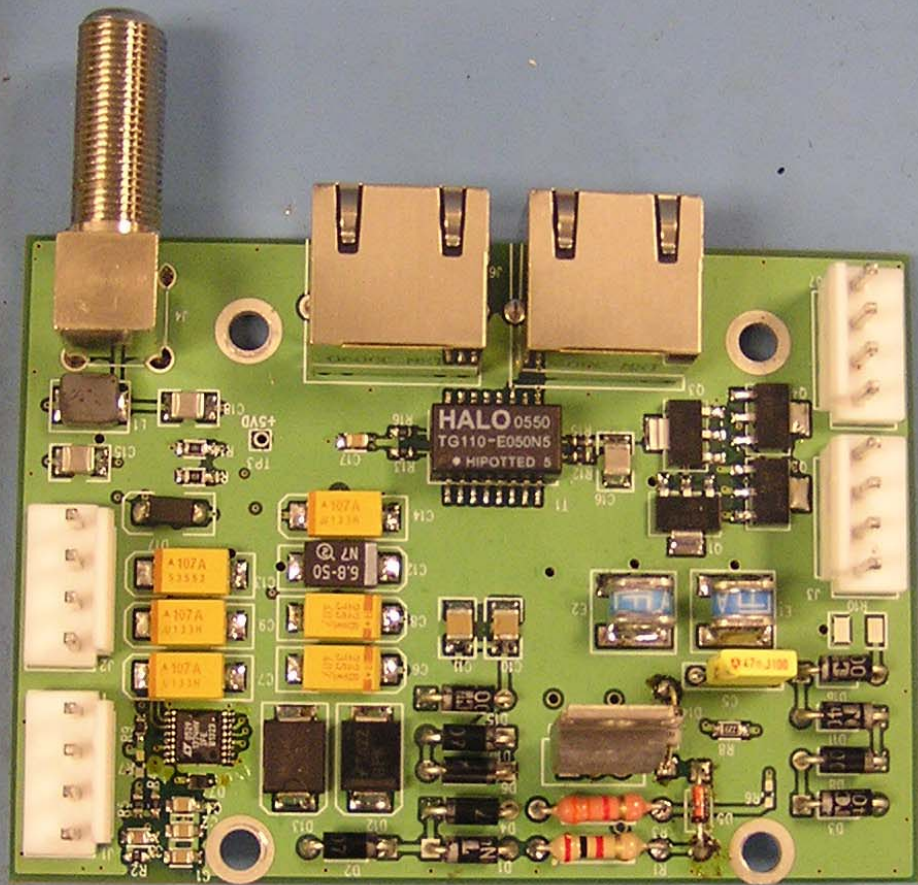

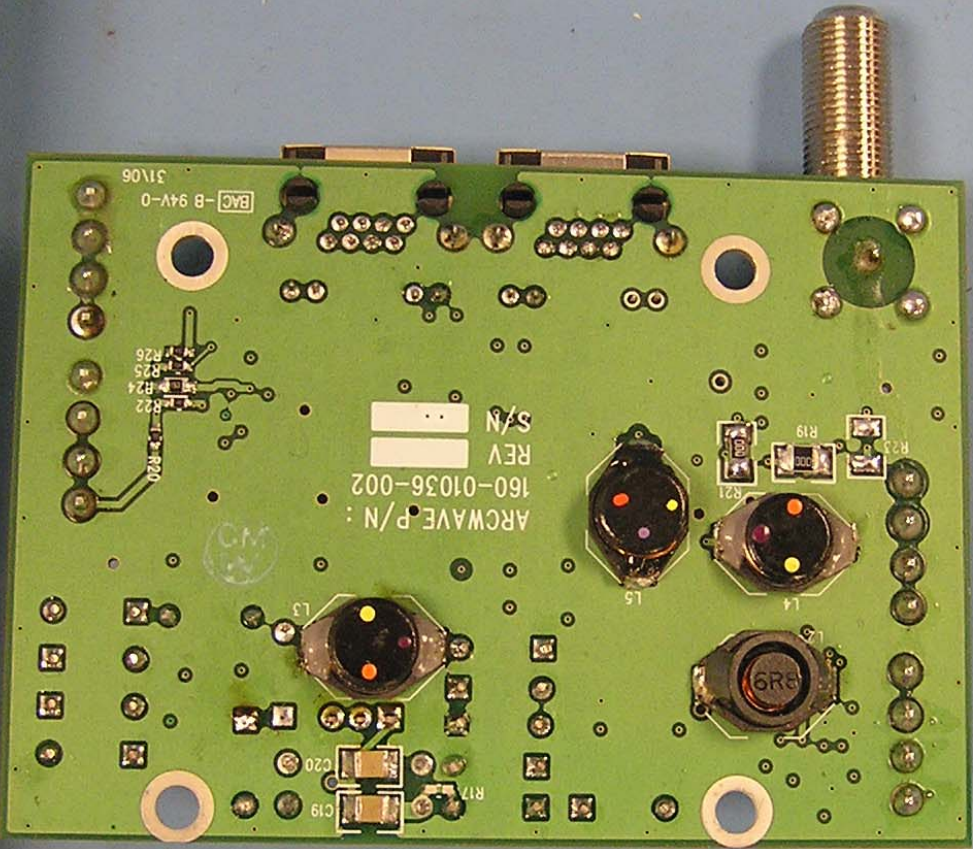

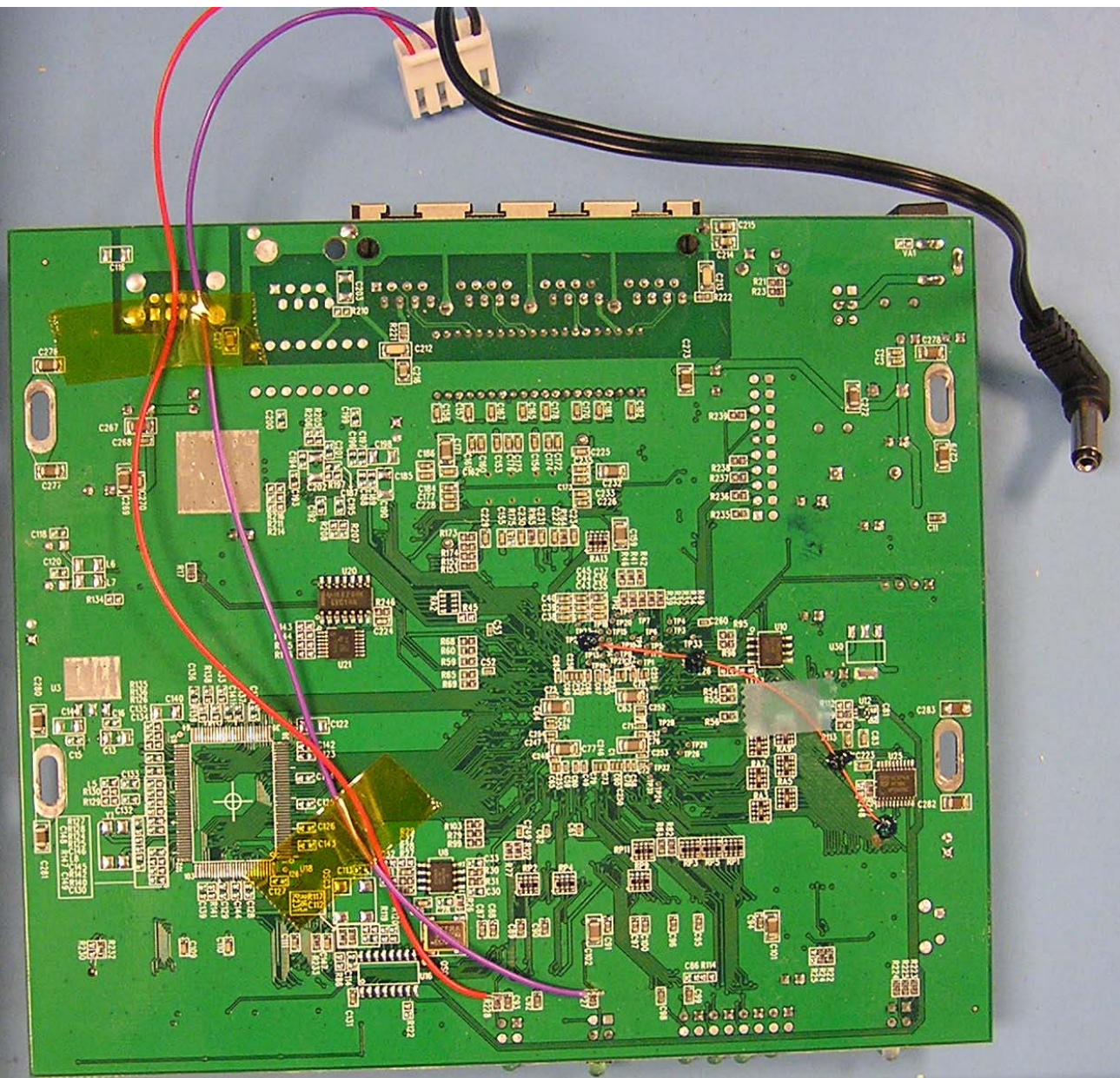
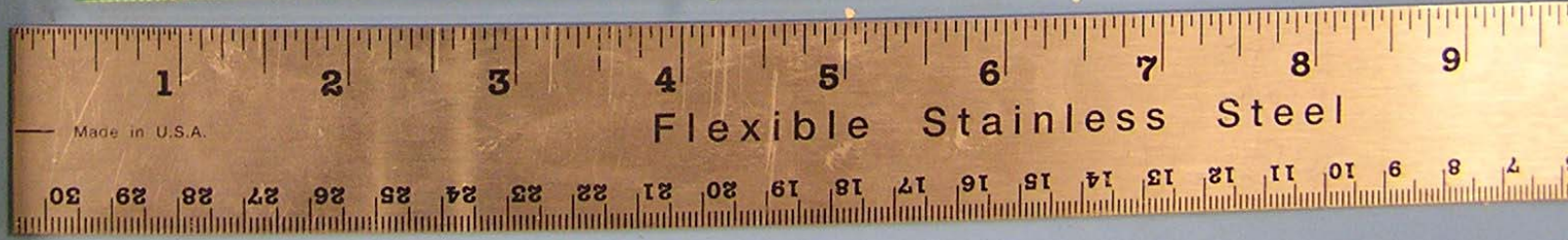

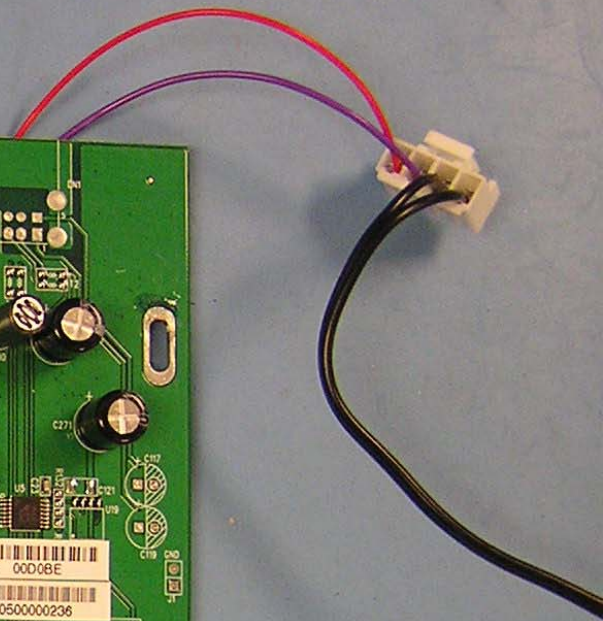
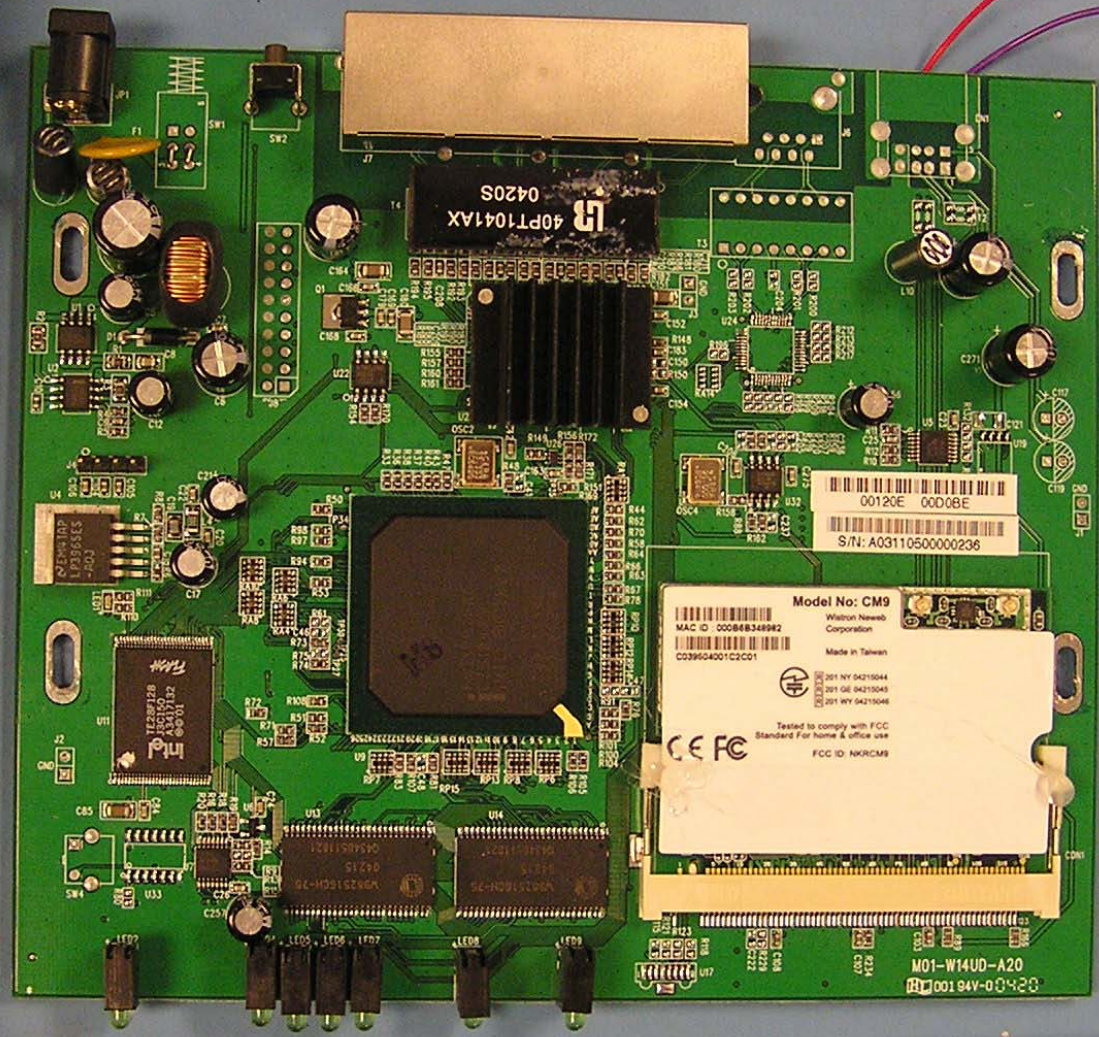



Model No: CM9

Wistron Neweb Corporation

Made in Taiwan



MAC ID : 000B6B348982



C039504001C2C01



201 NY 04215044

201 GE 04215045

201 WY 04215046

Tested to comply with FCC Standard For home & office use

FCC ID: NKRCM9



Made in U.S.A.

Flexible Stainless

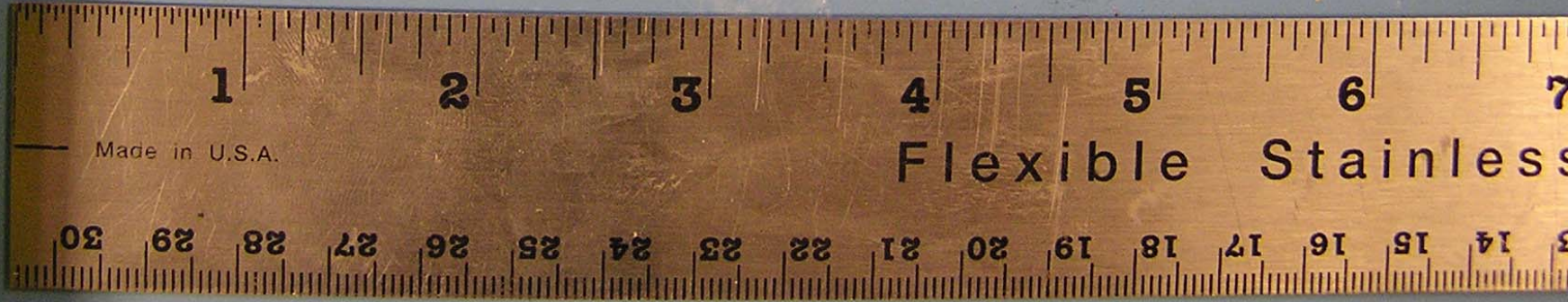
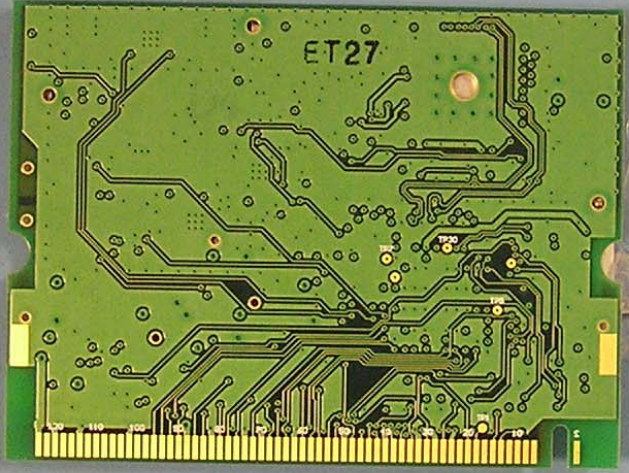

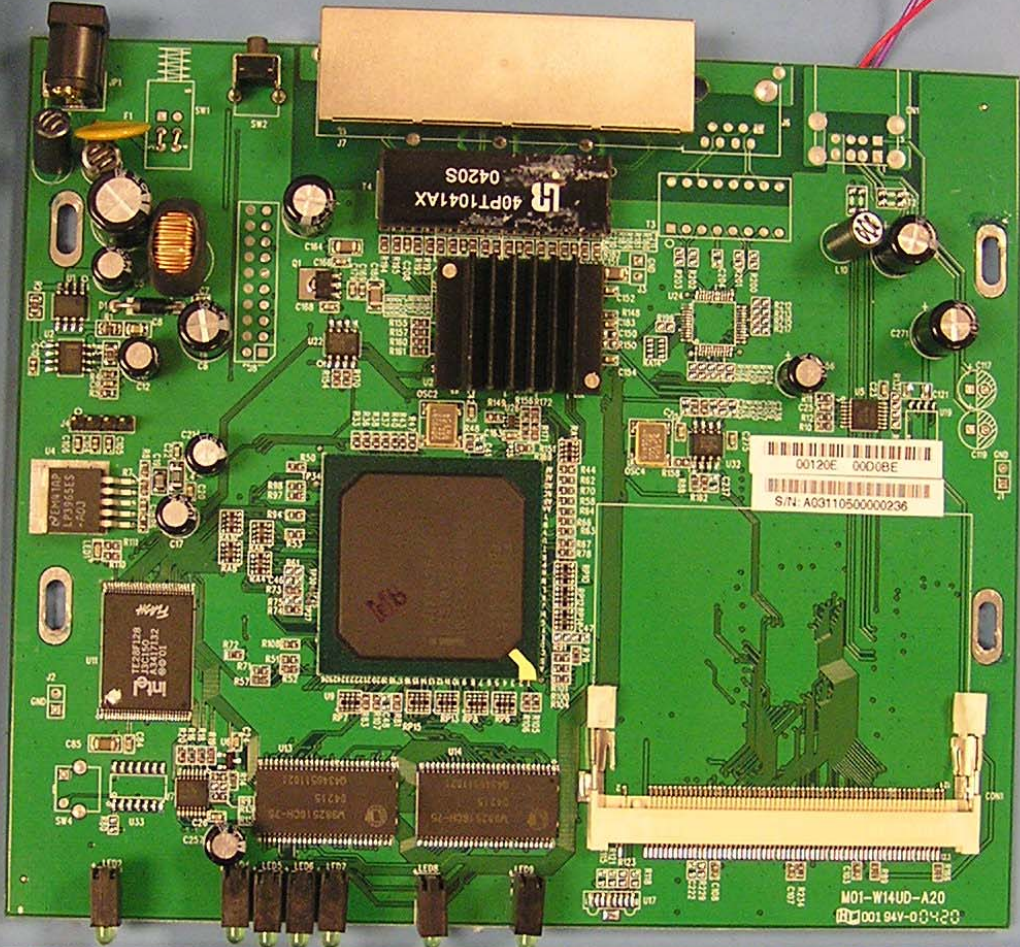

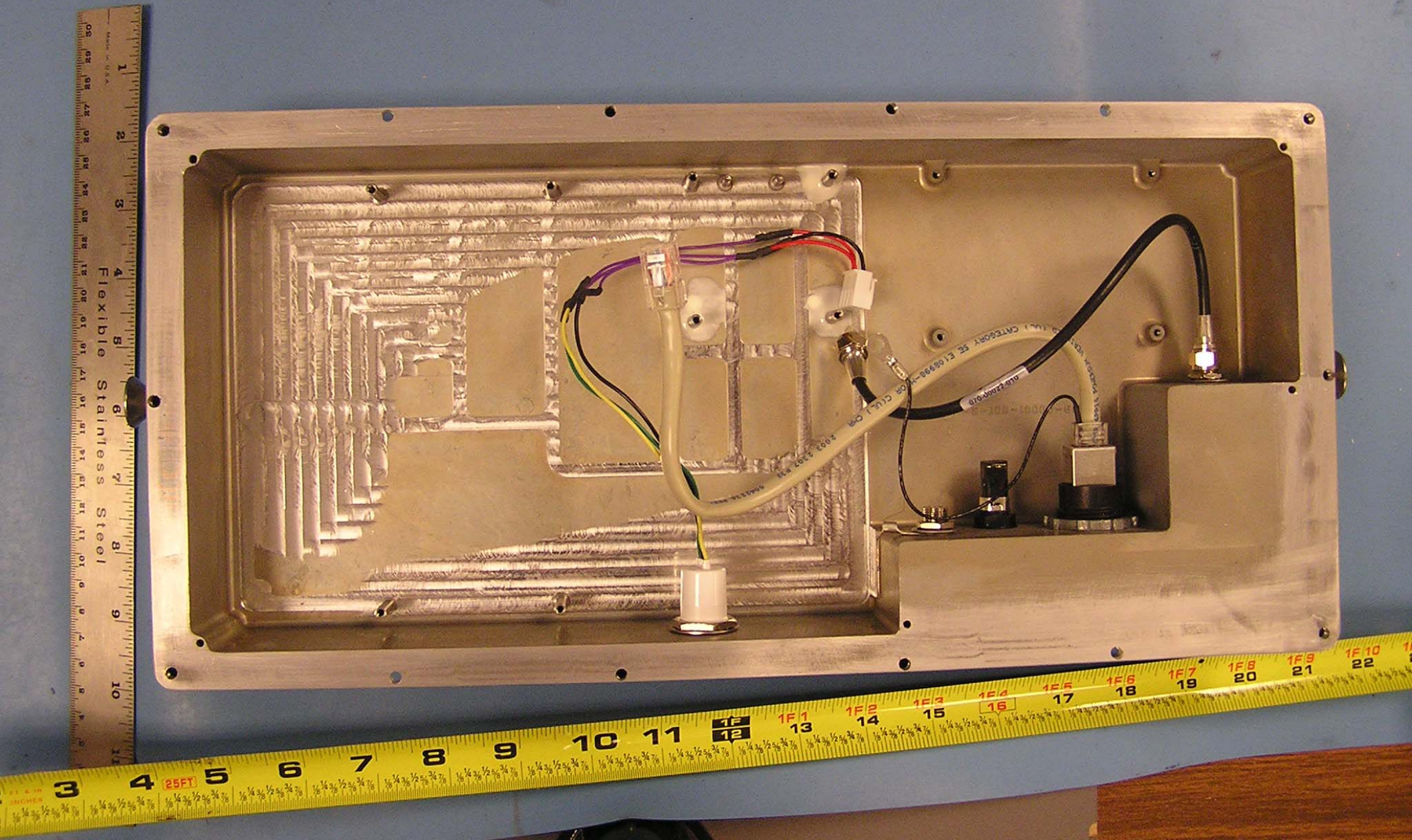

Flexible Stainless Steel

USA
MADE IN
AMERICA