



TEST REPORT

EUT Description	WLAN and BT, 2x2 PCIe M.2 1216 adapter card
Brand Name	Intel®
Model Name	BE201D2W
FCC / IC ID	PD9BE201D2 ; 1000M-BE201D2
Date of Test Start/End	2024-01-08 / 2024-02-21
Features	2x2 WiFi - Bluetooth® (see section 5)

Applicant	Intel Corporation S.A.S
Address	425 Rue de Goa – Le Cargo B6 – 06600 Antibes, FRANCE
Contact Person	Benjamin Lavenant
Telephone/Fax/ Email	Benjamin.lavenant@intel.com

Reference Standards	FCC CFR Title 47 Part 15 C RSS-247 issue 3, RSS-Gen A1 issue 5 - A1 (see section 1)
---------------------	---

Test Report identification	231120-06.TR08
Revision Control	Rev. 00 This test report revision replaces any previous test report revision (see section 8)

The test results relate only to the samples tested.
Reference to accreditation shall be used only by full reproduction of test report.

Issued by _____ Reviewed by _____

Robin Luciani
(Test Engineer Lead)

Zayd OUACHICHA
(Technical Manager)

Intel Corporation S.A.S – WRF Lab
425 rue de Goa – Le Cargo B6 - 06600, Antibes, France
Tel. +33493001400 / Fax +33493001401

Table of Contents

1. Standards, reference documents and applicable test methods	3
2. General conditions, competences and guarantees	3
3. Environmental Conditions	3
4. Test samples	4
5. EUT Features	5
6. Remarks and comments	5
7. Test Verdicts summary	6
7.1. 802.11 B/G/N/AX/BE 2.4GHZ	6
8. Document Revision History	6
Annex A. Test & System Description	7
A.1 MEASUREMENT SYSTEM.....	7
A.2 TEST EQUIPMENT LIST	9
A.3 MEASUREMENT UNCERTAINTY EVALUATION	10
Annex B. Test Results DTS	11
B.1 TEST CONDITIONS.....	11
B.2 TEST RESULTS TABLES	12
B.2.1 6dB & 99% Bandwidth	12
B.2.2 Maximum Output Power and antenna gain.....	15
B.2.3 Power Spectral Density	19
B.2.4 Out-of-band emission (conducted)	23
B.2.5 Radiated spurious emission.....	24
B.2.6 Out of band emissions - band-edge (conducted).....	42
Annex C. Photographs	69
C.1 TEST SETUP	69
C.2 TEST SAMPLE	71

1. Standards, reference documents and applicable test methods

FCC	<ol style="list-style-type: none"> 1. FCC Title 47 CFR part 15 - Subpart C – §15.247 Operation within the bands 902-928 MHz, 2400-2483.5 MHz, and 5725-5850 MHz. 2021-10-01 Edition 2. FCC Title 47 CFR part 15 - Subpart C – §15.209 Radiated emission limits; general requirements. 2021-10-01 Edition 3. FCC OET KDB 558074 D01 v05r02 - Guidance for compliance measurements on digital transmission system, frequency hopping spread spectrum system, and hybrid system devices operating under section 15.247 of the FCC rules. 4. FCC OET KDB 662911 D01 v02r01 - Emissions Testing of Transmitters with Multiple Outputs in the Same Band. 5. ANSI C63.10-2013 - American National Standard of Procedures for Compliance Testing of Unlicensed Wireless Devices
ISED	<ol style="list-style-type: none"> 1. RSS-247 Issue 3 - Digital Transmission Systems (DTSs), Frequency Hopping Systems (FHSs) and License-Exempt Local Area Network (LE-LAN) Devices. 2. RSS-Gen Issue 5 A1- General Requirements for Compliance of Radio Apparatus. 3. FCC OET KDB 558074 D01 v05r02 - Guidance for compliance measurements on digital transmission system, frequency hopping spread spectrum system, and hybrid system devices operating under section 15.247 of the FCC rules. 4. FCC OET KDB 662911 D01 v02r01 - Emissions Testing of Transmitters with Multiple Outputs in the Same Band. 5. ANSI C63.10-2013 - American National Standard of Procedures for Compliance Testing of Unlicensed Wireless Devices

2. General conditions, competences and guarantees

- ✓ Tests performed under FCC standards identified in section 1 are covered by A2LA accreditation.
- ✓ Tests performed under ISED standards identified in section 1 are covered by Cofrac accreditation.
- ✓ Intel Corporation SAS Wireless RF Lab (Intel WRF Lab) is an ISO/IEC 17025:2017 laboratory accredited by the American Association for Laboratory Accreditation (A2LA) with the certificate number 3478.01.
- ✓ Intel Corporation SAS Wireless RF Lab (Intel WRF Lab) is an Accredited Test Firm recognized by the FCC, with Designation Number FR0011.
- ✓ Intel Corporation SAS Wireless RF Lab (Intel WRF Lab) is an ISO/IEC 17025:2017 testing laboratory accredited by the French Committee for Accreditation (Cofrac) with the certificate number 1-6736.
- ✓ Intel Corporation SAS Wireless RF Lab (Intel WRF Lab) is a Registered Test Site listed by ISED, with ISED #1000Y and CAB identifier FR0005.
- ✓ Intel WRF Lab only provides testing services and is committed to providing reliable, unbiased test results and interpretations.
- ✓ Intel WRF Lab is liable to the client for the maintenance of the confidentiality of all information related to the item under test and the results of the test.
- ✓ Intel WRF Lab has developed calibration and proficiency programs for its measurement equipment to ensure correlated and reliable results to its customers.
- ✓ This report is only referred to the item that has undergone the test.
- ✓ This report does not imply an approval of the product by the Certification Bodies or competent Authorities.

3. Environmental Conditions

- ✓ At the site where the measurements were performed the following limits were not exceeded during the tests:

Temperature	23.3°C ± 0.6°C
Humidity	36.4% ± 3.2%

4. Test samples

Sample	Control #	Description	Model	Serial #	Date of receipt	Note
#01	231120-05.S13	WiFi 7 Module	BE201D2W	F8FE5ECDCA67	2024-02-06	Used for RF conducted tests
	200904-01.S10	Laptop	HP Opel	000075059C	2023-04-24	
	231109-03.S46	Extender Board	CRF DB 2230 BNJ	2202227961	2023-11-16	
#02	231120-05.S03	WiFi 7 Module	BE201D2W	60452EB8A3BC	2024-01-05	Used for Radiated Spurious Emissions tests
	220225-03.S07	Microwave Absorber	Eccosorb BSR-1	-	2022-03-14	
	231109-03.S48	Adaptor	PCB00866-00_A	124627	2023-11-24	
	200611-03.S31	Extender	ADEXELEC	-	2020-08-19	
	200504-04.S07	Laptop	Latitude 5401	BVHLK13	2020-06-02	
	230223-02.S47	Triband Antenna	-	005	2023-04-20	
	230223-02.S48	Triband Antenna	-	006	2023-04-20	
	231120-05.S21	WiFi 7 Module	BE201D2W	F8FE5CDCA49	2024-02-07	
	180001-01.S21	Socket	1216SD to M.2	-	2021-06-07	
#03	231120-05.S02	WiFi 7 Module	BE201D2W	60452EB8A407	2024-01-05	Used for Radiated Spurious Emissions tests
	220225-03.S07	Microwave Absorber	Eccosorb BSR-1	-	2022-03-14	
	231109-03.S47	Adaptor	PCB00866-00_A	124727	2023-11-24	
	220915-09.S01	Extender	ADEXELEC	-	2022-04-06	
	200611-03.S30	Laptop	Latitude 5401	6DJLK13	2020-08-19	
	230223-02.S49	Triband Antenna	-	007	2023-04-20	
	230223-02.S50	Triband Antenna	-	008	2023-04-20	
	231120-05.S20	WiFi 7 Module	BE201D2W	F8FE5ECDCB43	2024-02-07	
	180001-01.S21	Socket	1216SD to M.2	-	2021-06-07	

5. EUT Features

The herein information is provided by the customer

Intel WRF Lab declines any responsibility for the accuracy of the stated customer provided information, especially if it has any impact on the correctness of test results presented in this report

Brand Name	Intel®		
Model Name	BE201D2W		
Software Version	DRTU.05312.99.0.85 / DRTU.05726.99.0.86		
Driver Version	99.0.86.3		
Prototype / Production	Production		
Supported Radios	802.11b/g/n/ax/be	2.4GHz	
	802.11a/n/ac/ax/be	5.2GHz	
		5.6GHz	
		5.8GHz	
	802.11ax/be	6.0GHz	
	Bluetooth	2.4GHz	
Antenna Information	Transmitter	Chain A(1)	Chain B(2)
	Manufacturer	Intel WRF Lab	Intel WRF Lab
	Antenna type	PIFA	PIFA
	Part number	WRF-Tri Band-Antenna	WRF-Tri Band-Antenna
	Declared Antenna gain (dBi)	+2.95	+2.95

6. Remarks and comments

1. No deviations were made from the test methods listed in section 1 of this report

7. Test Verdicts summary

The statement of conformity to applicable standards in the table below are based on the measured values, without taking into account the measurement uncertainties.

7.1. 802.11 b/g/n/ax/be 2.4GHz

FCC part	RSS part	Test name	Verdict
15.247 (a) (2)	RSS-247 Clause 5.2 (a)	6dB Bandwidth	P
15.247 (b) (3)	RSS-247 Clause 5.4 (d)	Maximum output power and E.I.R.P	P
15.247 (e)	RSS-247 Clause 5.2 (b)	Power spectral density	P
15.247 (d) 15.209	RSS-247 Clause 5.5 RSS-Gen A1 Clause 8.9	Out-of-band Emissions (conducted)	P
15.247 (d) 15.209	RSS-247 Clause 5.5 RSS-Gen A1 Clause 8.9	Spurious Emissions (radiated)	P

P: Pass
F: Fail
NM: Not Measured
NA: Not Applicable

8. Document Revision History

Revision #	Modified by	Revision Details
Rev. 00	K.KHATIB T.MATHIEU	First Issue

Annex A. Test & System Description

A.1 Measurement System

Measurements were performed using the following setups, made in accordance to the general provisions of FCC OET KDB 558074 D01 DTS Meas Guidance.

The DUT was installed in a test fixture and this test fixture is connected to a laptop computer and AC/DC power adapter. The laptop computer was used to configure the EUT to continuously transmit at a specified output power using all different modes and modulation schemes, using the Intel proprietary tool DRTU.

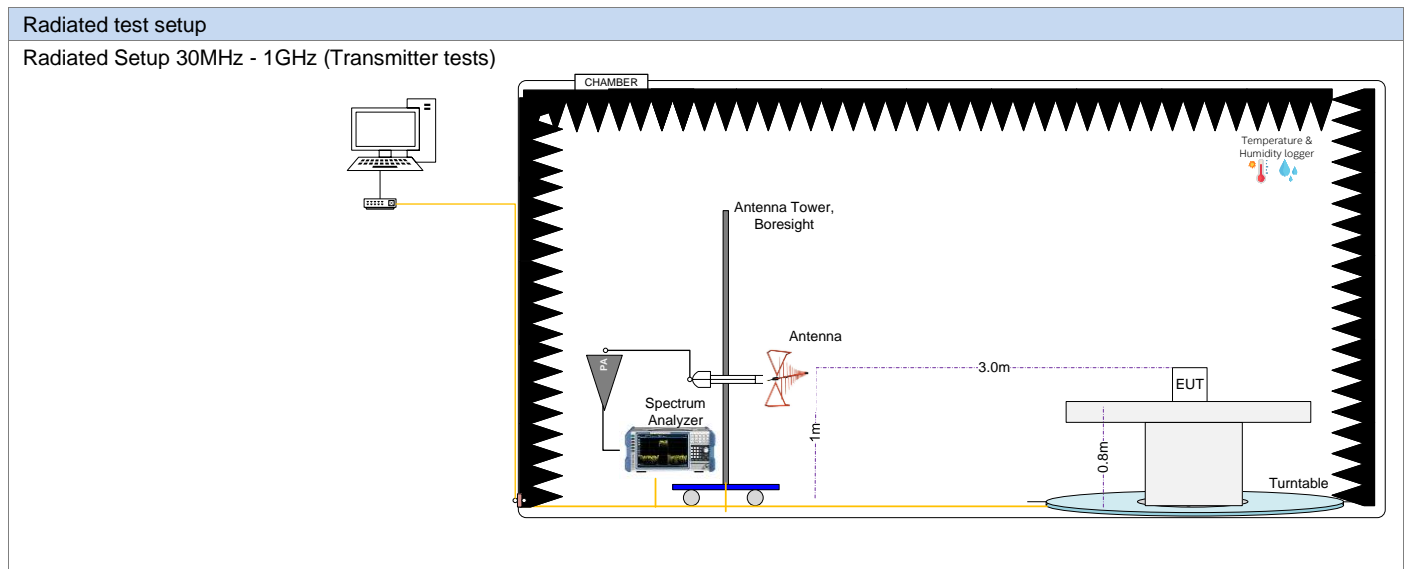
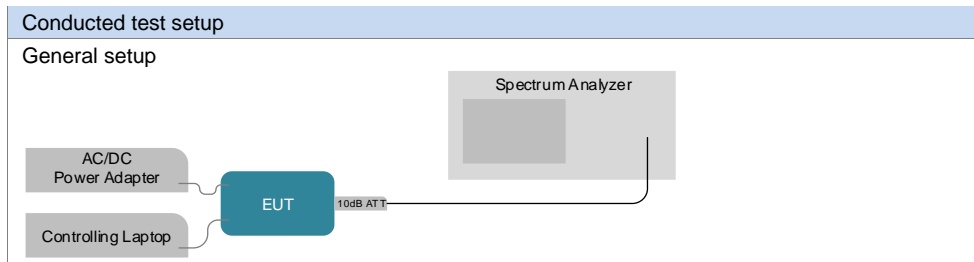

Radiated Setup 1GHz – 11GHz (Transmitter tests)

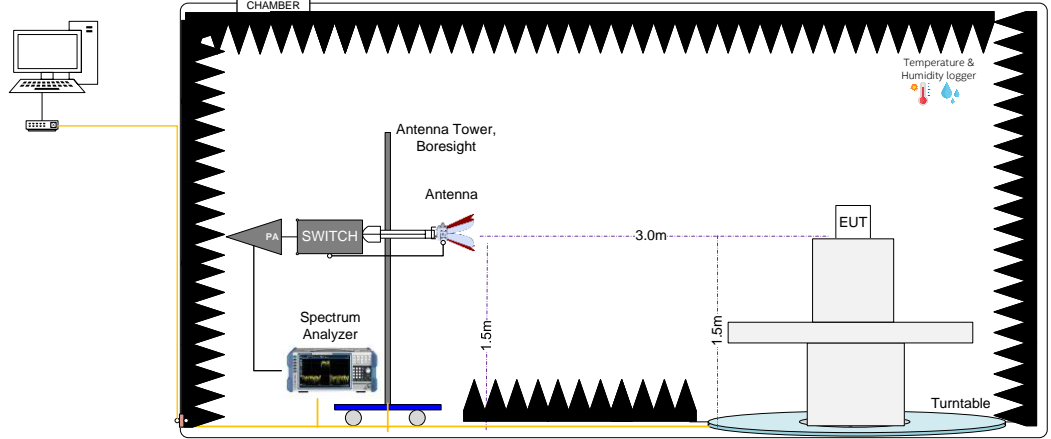

Radiated Setup 11GHz – 26GHz (Transmitter tests)

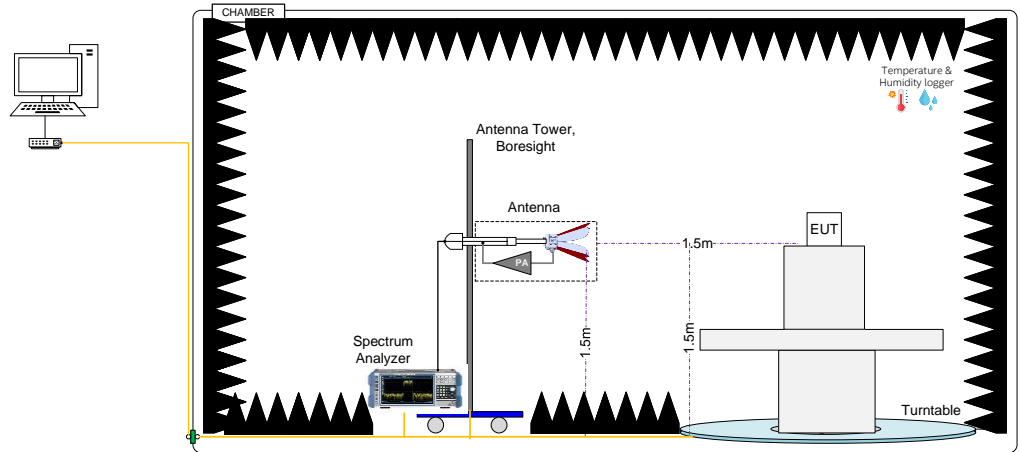

Sample Calculation

The spurious received voltage V (dB μ V) in the spectrum Analyzer is converted to Electric field strength using the transducer factor F corresponding to the Rx path Loss:

$$F \text{ (dB/m)} = \text{Rx Antenna Factor (dB/m)} + \text{Cable losses (dB)} - \text{Amplifiers Gain (dBi)}$$

$$E \text{ (dB}\mu\text{V)} = V \text{ (dB}\mu\text{V)} + F \text{ (dB/m)}$$

For field strength measurements made at other than the distance at which the applicable limit is specified, the field strength of the emission at the distance specified by the limit is deduced as follows:

$$E_{\text{SpecLimit}} = E_{\text{Meas}} + 20 \cdot \log(D_{\text{Meas}}/D_{\text{SpecLimit}})$$

where

$E_{\text{SpecLimit}}$ is the field strength of the emission at the distance specified by the limit, in dB μ V/m

E_{Meas} is the field strength of the emission at the measurement distance, in dB μ V/m

D_{Meas} is the measurement distance, in m

$D_{\text{SpecLimit}}$ is the distance specified by the limit, in m

A.2 Test Equipment List

Conducted setup

ID#	Device	Type/Model	Serial #	Manufacturer	Cal. Date	Cal. Due Date
018-002	Peak Power Meter	MA24406A	11138	ANRITSU	2023-10-05	2025-10-05
159-000	Spectrum Analyzer	FSV40	101072	Rohde & Schwarz	2023-03-23	2025-03-23
019-000	RF cable 100cm	PE360-100	N/A	PASTERNAK	2023-03-03	2024-03-03
019-002	10dB Attenuator + MH4	PE7395-10	N/A	PASTERNAK	2023-03-03	2024-03-03
363-000	Temp & Humidity Logger	RA12E-TH1-RAS	RA12-D0EB1A	AVITECH	2023-09-28	2025-09-28
413-000	Measurement SW v1.5.4.2	Octopi	N/A	Step AT	N/A	N/A

Radiated Setup #1

ID#	Device	Type/Model	Serial #	Manufacturer	Cal. Date	Cal. Due Date
006-000*	Anechoic Chamber	FACT3	5720	ETS-Lindgren	2022-01-21	2024-02-21
006-008	Measurement SW, v11.30	EMC32	100623	Rohde & Schwarz	N/A	N/A
259-000	Temp & Humidity Logger	RA12E-TH-RAS	RA12-B9BD70	Avtech	2022-06-27	2024-06-27
006-001	Turn Table	ETS	-	ETS-Lindgren	N/A	N/A
006-011	Boresight antenna mast	BAM 4.0-P	P/278/2890.01	Maturo	N/A	N/A
007-008	Double Horn Ridged antenna +PA	3116C-PA	00169308bis + 00196308	ETS-Lindgren	2023-0-30	2025-05-30
057-000	Double Horn Ridged antenna	3117	167062	ETS-Lindgren	2022-07-08	2024-07-08
058-000	Double Horn Ridged antenna	3116C	157511	ETS-Lindgren	2022-10-21	2024-10-21
006-061	Bi-Log Periodic antenna	CBL6143A	61382	Teseq	2022-10-24	2024-10-24
147-000	Spectrum analyzer	FSW43	101847	Rohde & Schwarz	2022-11-30	2024-11-30
301-000	Amplifier 9kHz-1300MHz	8447F	3113A07440	HP	2023-03-03	2024-03-03
261-000**	Amplifier 1GHz-18GHz	3117-PA	00157993	ETS-Lindgren	2023-02-20	2024-02-20
502-006	Amplifier 0.5GHz-40GHz	DEPA0540-43	2023A05	Diamond Engineering	2023-06-09	2024-06-09
009-007	RF Filter	ZHSS-k11G+	8493 1831830	Mini-Circuits	2023-06-09	2024-06-09
006-068	RF Switch	RC-2SP6T-40	02112090061	Micro-Circuits	2023-08-22	2024-08-22
006-066	Cable 7m – 25MHz to 40GHz	R286304174	20.46.370	Radiall	2023-08-16	2024-08-16
006-063	Cable 30cm – 1GHz to 40GHz	PE371-12	-	Pasternack	2023-02-27	2024-02-27
006-064	Cable 30cm – 1GHz to 40GHz	PE371-12	-	Pasternack	2023-02-27	2024-02-27
006-065	Cable 60cm – 25MHz to 1GHz	PE300-24	-	Pasternack	2023-06-02	2024-06-02

N/A: Not Applicable

*Within a grace period of 30 days

** This equipment wasn't used outside its calibration period.

Radiated Setup #2

ID#	Device	Type/Model	Serial #	Manufacturer	Cal. Date	Cal. Due Date
007-000	Anechoic chamber	RFD-FA-100	5996	ETS Lindgren	2021-09-14	2024-03-14
127-000	Spectrum Analyzer	FSV40	101358	Rohde & Schwarz	2023-01-27	2025-01-27
007-007	Double Ridge Horn (1- 18GHz)	3117	00152266	ETS Lindgren	2022-03-29	2024-03-29
007-006	Switch & Positioner	EMCenter	00151232	ETS Lindgren	N/A	N/A
059-000	Double Ridge Horn (1- 18GHz)	3117	201542	ETS-Lindgren	2023-09-26	2025-09-26
264-000**	Amplifier 1GHz-18GHz	3117-PA	00169546	ETS-Lindgren	2023-02-20	2024-02-20
007-011	RF Cable 1-18GHz - 6.5m	140-8500-11-51	001	Atem	2023-02-15	2024-02-15
007-005	Measurement SW, v11.20.00	EMC32	100401	Rohde & Schwarz	N/A	N/A
007-003	Antenna Tower	2171B-3.0M	00150123	ETS Lindgren	N/A	N/A
007-002	Turntable	-	-	ETS Lindgren	N/A	N/A
007-014*	RF Cable 18-40 GHz 6m	R286304009	1747364	Radiall	2023-02-16	2024-03-16
007-022*	RF Cable 1-18GHz, 1.5m	0501050991200GX	19.23.493	Radiall	2023-02-13	2024-03-13
007-015*	RF Cable 1GHz-18GHz 1.5m	-	-	Spirent	2023-02-13	2024-03-13
007-018*	RF Cable 1-9.5GHz 1.2m	0500990991200KE	-	Radiall	2023-02-13	2024-03-13
007-020*	RF Cable 1-18GHz, 1.2 m	2301761761200PJ	12.22.1104	Radiall	2023-02-15	2024-03-15
349-000	Temp & Humidity Logger	RA12E-TH1-RAS	RA12-D4F8C3	Avtech	2023-11-30	2025-11-30

N/A: Not Applicable

*Within a grace period of 30 days

** This equipment wasn't used outside its calibration period.

Shared Radiated Equipment

ID#	Device	Type/Model	Serial #	Manufacturer	Cal. Date	Cal. Due Date
412-000	DRTU Power finder V2.1	-	-	Intel	NA	NA
139-000	Power Sensor	NRP-Z81	104383	Rohde & Schwarz	2023-04-21	2025-04-21
061-000	Power Sensor	NRP-Z81	104386	Rohde & Schwarz	2022-03-25	2024-03-25
140-000	Power Sensor	NRP-Z81	104382	Rohde & Schwarz	2022-03-25	2024-03-25
423-000	Power Sensor	NRP-Z81	101152	Rohde & Schwarz	2022-05-18	2024-05-18

N/A: Not Applicable

A.3 Measurement Uncertainty Evaluation

The system uncertainty evaluation is shown in the table below with a coverage factor of $k = 2$ to indicate a 95% level of confidence:

Measurement type	Uncertainty	Unit
Timing	± 0.12	%
Power Spectral density	± 1.47	dB
Occupied bandwidth	± 2.07	%
Conducted Power	± 1.03	dB
Conducted Spurious Emission <26.5 GHz	± 2.93	dB
Radiated tests <1GHz	± 6.40	dB
Radiated tests 1GHz – 26.5 GHz	± 5.92	dB

Annex B. Test Results DTS

The herein test results were performed by:

Test case measurement	Test Peronnel
6dB Bandwidth	T.MATHIEU
Maximum output power and E.I.R.P	T.MATHIEU
Power spectral density	T.MATHIEU
Out-of-band Emissions (conducted)	T.MATHIEU
Spuirous Emissions (radiated)	K.KHATIB, R.SIMONINI

B.1 Test Conditions

For 802.11b/g modes the EUT can transmit at both CHAIN A and CHAIN B RF outputs individually, but not simultaneously.

For 802.11n20 & 802.11ax/be20 (20 MHz channel bandwidth), 802.11n40 & 802.11ax/be40 (40MHz channel bandwidth) modes the EUT can transmit at both CHAIN A and CHAIN B RF outputs individually, and also simultaneously.

The following data rates were selected based on preliminary testing that identified those rates as the worst cases for output power and spurious levels at the band edges:

Transmission	Mode	Bandwidth (MHz)	Worst Case Data Rate
SISO	802.11b	20	1Mbps
	802.11g	20	6Mbps
	802.11n	20	MCS0
		40	MCS0
	802.11ax/be	20	MCS0
		40	MCS0
MIMO	802.11n	20/40	HT8
	802.11ax/be	20/40	MCS0

B.2 Test Results Tables

B.2.1 6dB & 99% Bandwidth

Test limits

FCC part	RSS part	Limits
15.247 (a) (2)	RSS-247 Clause 5.2 (a)	Systems using digital modulation techniques may operate in the 902-928 MHz, 2400-2483.5 MHz, and 5725-5850 MHz bands. The minimum 6 dB bandwidth shall be at least 500 kHz.

Test procedure

The conducted setup shown in section *Test & System Description* was used to measure the 6dB & 99% Bandwidth. The antenna terminal of the EUT is connected to the spectrum through an attenuator, and the spectrum analyzer reading is compensated to include the RF path loss.

Results tables

Mode	Rate	Antenna	Channel	Freq [MHz]	6dB BW [MHz]	99% BW [MHz]
802.11b	1Mbps	SISO A	1	2412	8.99	13.45
			7	2442	9.04	13.69
			11	2462	9.00	13.48
			12	2467	9.04	13.49
			13	2472	9.03	13.45
		SISO B	1	2412	8.55	13.44
			7	2442	9.07	13.39
			11	2462	9.05	13.42
			12	2467	8.55	13.43
			13	2472	8.56	13.41
802.11g	6Mbps	SISO A	1	2412	15.30	16.73
			7	2442	13.48	16.71
			11	2462	13.85	16.71
			12	2467	15.08	16.72
			13	2472	16.35	16.41
		SISO B	1	2412	15.10	16.69
			7	2442	15.09	16.65
			11	2462	15.01	16.67
			12	2467	15.07	16.67
			13	2472	16.35	16.43
802.11n20	MCS0	SISO A	1	2412	15.92	17.79
			7	2442	15.08	17.79
			11	2462	15.03	17.76
			12	2467	15.06	17.77
		SISO B	13	2472	17.59	17.59
			1	2412	15.06	17.77
			7	2442	15.02	17.78
			11	2462	15.08	17.76
	HT8	MIMO A	12	2467	15.66	17.75
			13	2472	17.59	17.59
			1	2412	14.64	17.81
			7	2442	15.07	17.79
		MIMO B	11	2462	15.05	17.79
			12	2467	14.98	17.81
			13	2472	17.59	17.59
			1	2412	15.69	17.74
802.11n40	MCS0	SISO A	7	2442	32.61	36.21
			9	2452	34.38	36.20
			10	2457	32.55	36.20
			11	2462	35.29	36.13
		SISO B	3	2422	36.34	36.31
			7	2442	34.33	36.18
			9	2452	34.99	36.21
			10	2457	33.07	36.19
	HT8	MIMO A	11	2462	33.79	36.10
			3	2422	36.36	36.30
			7	2442	31.28	36.20
			9	2452	35.03	36.20
		MIMO B	10	2457	34.94	36.22
			11	2462	33.89	36.11
			3	2422	36.35	36.32
			7	2442	36.35	36.32
			9	2452	32.93	36.13
			7	2442	32.93	36.13
			9	2452	35.03	36.09
			10	2457	35.00	36.10
			11	2462	35.67	36.02
			11	2462	36.38	36.25

Mode	Rate	Antenna	Channel	Freq [MHz]	RU config.	6dB BW [MHz]	99% BW [MHz]		
802.11ax/be20	MCS0	SISO A	1	2412	Full	17.60	18.92		
					26/0	2.02	17.94		
					52/37	17.02	17.64		
					106/53	17.14	17.59		
			7	2442	Full	17.69	18.92		
					11	2462	Full	17.15	18.91
					12	2467	Full	17.79	18.94
					13	2472	Full	18.49	18.76
			13	2472	26/8	1.96	17.74		
					52/40	16.89	17.55		
					106/54	16.87	17.65		
					Full	17.42	18.91		
		SISO B	1	2412	26/0	2.08	17.47		
					52/37	16.96	17.52		
					106/53	17.07	17.91		
					Full	15.37	18.91		
			7	2442	11	2462	Full	15.04	18.93
					12	2467	Full	17.51	18.92
					13	2472	Full	18.41	18.74
					26/8	1.92	17.68		
			13	2472	52/40	15.67	17.45		
					106/54	15.65	17.82		
					Full	15.89	18.92		
					26/0	2.01	18.07		
		MIMO A	1	2412	52/37	17.02	17.93		
					106/53	17.10	17.76		
					Full	16.25	18.93		
					11	2462	Full	15.41	18.93
			7	2442	12	2467	Full	16.33	18.90
					13	2472	Full	18.48	18.75
					26/8	1.94	17.71		
					52/40	16.92	17.73		
			13	2472	106/54	16.88	17.54		
					Full	15.13	18.93		
					26/0	2.09	17.89		
					52/37	14.49	16.87		
		MIMO B	1	2412	106/53	17.14	16.65		
					Full	15.11	18.92		
					11	2462	Full	14.44	18.89
					12	2467	Full	15.07	18.91
			7	2442	13	2472	Full	18.70	18.74
					26/8	1.98	16.56		
					52/40	14.36	17.72		
					106/54	16.95	17.21		
			13	2472	Full	35.98	37.65		
					242/61	17.53	18.90		
					7	2442	Full	37.67	37.60
					9	2452	Full	35.68	37.63
SISO A	10	2457	Full	34.99	37.53				
			11	2462	Full	37.79	37.65		
			242/62	18.22	18.64				
			3	2422	Full	35.31	37.61		
	7	2442	242/61	17.97	18.85				
			9	2452	Full	35.15	37.61		
			10	2457	Full	36.68	37.59		
			11	2462	Full	35.51	37.57		
	13	2472	Full	37.88	37.66				
			242/62	18.37	18.62				
			3	2422	Full	36.99	37.63		
			7	2442	242/61	16.74	18.87		
SISO B	10	2457	Full	35.02	37.63				
			9	2452	Full	35.73	37.63		
			11	2462	Full	35.92	37.57		
			10	2457	Full	35.92	37.57		
	7	2442	11	2462	Full	37.50	37.63		
			242/62	18.39	18.63				
			3	2422	Full	35.11	37.60		
			7	2442	242/61	16.19	18.84		
	13	2472	9	2452	Full	34.94	37.61		
			10	2457	Full	35.78	37.63		
			11	2462	Full	32.80	37.62		
			11	2462	Full	37.70	37.64		
MIMO A	11	2462	242/62	18.50	18.66				
			3	2422	Full	35.11	37.60		
			7	2442	Full	34.94	37.61		
			9	2452	Full	35.78	37.63		
MIMO B	11	2462	10	2457	Full	32.80	37.62		
			11	2462	Full	37.70	37.64		
			10	2457	Full	32.80	37.62		
			11	2462	Full	37.70	37.64		

Max Value

B.2.2 Maximum Output Power and antenna gain

Test limits

	Limits
FCC Part 15.247 (b) (3)	<p>(b) The maximum peak conducted output power of the intentional radiator shall not exceed the following:</p> <p>(3) For systems using digital modulation in the 902-928 MHz, 2400-2483.5 MHz, and 5725-5850 MHz bands: 1 Watt. As an alternative to a peak power measurement, compliance with the one Watt limit can be based on a measurement of the maximum conducted output power. Maximum Conducted Output Power is defined as the total transmit power delivered to all antennas and antenna elements averaged across all symbols in the signaling alphabet when the transmitter is operating at its maximum power control level. Power must be summed across all antennas and antenna elements. The average must not include any time intervals during which the transmitter is off or is transmitting at a reduced power level.</p> <p>(4) The conducted output power limit specified in paragraph (b) of this section is based on the use of antennas with directional gains that do not exceed 6 dBi.</p>
RSS-247 Clause 5.4 (d)	<p>For DTSs employing digital modulation techniques operating in the bands 902-928 MHz and 2400-2483.5 MHz, the maximum peak conducted output power shall not exceed 1W. The e.i.r.p. shall not exceed 4 W, except as provided in section 5.4(e).</p> <p>As an alternative to a peak power measurement, compliance can be based on a measurement of the maximum conducted output power. The maximum conducted output power is the total transmit power delivered to all antennas and antenna elements, averaged across all symbols in the signalling alphabet when the transmitter is operating at its maximum power control level. Power must be summed across all antennas and antenna elements. The average must not include any time intervals during which the transmitter is off or transmitting at a reduced power level. If multiple modes of operation are implemented, the maximum conducted output power is the highest total transmit power occurring in any mode.</p>

Test procedure

The Maximum Peak Conducted Output Power was measured using a broadband peak power meter methods for 20MHz and 40MHz channel bandwidth as authorized in chapter 2.0 “*Power limits, definitions and device configuration*” of FCC OET KDB 558074 D01.

For MIMO mode, according to the measure-and-sum approach defined in FCC OET KDB 662911 D01 - Guidance for Emission Testing of Transmitters with Multiple Outputs in the Same Band, the conducted emission level (e.g., transmit power or power in specified bandwidth) is measured at each antenna port. The measured results at the various antenna ports are then summed mathematically in linear power units to determine the total emission level from the device.

The EIRP power (dBm) is calculated by adding the declared maximum antenna gain to the measured conducted power.

The conducted setup shown in section *Test & System Description* was used to measure the maximum conducted output power. The antenna terminal of the EUT is connected to the spectrum through an attenuator, and the spectrum analyzer reading is compensated to include the RF path loss.

Results tables:

Maximum peak power are shown in table below with min and max values highlighted. Maximum average output power are shown for indicative purpose only

Mode	Rate	# Ch	Freq [MHz]	Ant	Meas Peak Cond.Power [dBm]	EIRP [dBm]	EIRP [mW]	Peak Cond.Power [mW]	Meas. Avg Cond.Power [dBm]	Max. Avg Cond.Power* [dBm]	EIRP [mW]	Avg Cond.Power [mW]	
802.11b	1Mbps	1	2412	SISO A	25.87	28.87	770.90	386.37	22.71	22.71	372.39	186.64	
				SISO B	25.88	28.88	772.68	387.26	22.78	22.78	378.44	189.67	
		7	2442	SISO A	26.31	29.31	853.10	427.56	23.14	23.14	411.15	206.06	
				SISO B	27.27	30.27	1064.14	533.33	24.15	24.15	518.80	260.02	
		11	2462	SISO A	26.26	29.26	843.33	422.67	23.09	23.09	406.44	203.70	
				SISO B	27.43	30.43	1104.08	553.35	24.25	24.25	530.88	266.07	
12	2467	SISO A	24.48	27.48	559.76	280.54	21.30	21.30	269.15	134.90			
		SISO B	25.33	28.33	680.77	341.19	22.18	22.18	329.61	165.20			
13	2472	SISO A	22.52	25.52	356.45	178.65	19.34	19.34	171.40	85.90			
		SISO B	22.88	25.88	387.26	194.09	19.72	19.72	187.07	93.76			
802.11g	6Mbps	1	2412	SISO A	24.71	27.71	590.20	295.80	20.63	20.73	235.86	118.21	
				SISO B	25.85	28.85	767.36	384.59	21.98	22.08	321.86	161.31	
		7	2442	SISO A	29.52	32.52	1786.49	895.36	21.13	21.23	264.64	132.64	
				SISO B	25.75	28.75	749.89	375.84	22.59	22.69	370.39	185.64	
		11	2462	SISO A	29.26	32.26	1682.67	843.33	20.87	20.97	249.26	124.93	
				SISO B	24.87	27.87	612.35	306.90	21.72	21.82	303.15	151.94	
12	2467	SISO A	25.70	28.70	741.31	371.54	17.32	17.42	110.07	55.16			
		SISO B	26.49	29.49	889.20	445.66	18.12	18.22	132.33	66.32			
13	2472	SISO A	21.63	24.63	290.40	145.55	13.56	13.66	46.31	23.21			
		SISO B	22.88	25.88	387.26	194.09	14.79	14.89	61.47	30.81			
802.11n20	MCS0	1	2412	SISO A	28.66	31.66	1465.55	734.51	20.38	20.38	217.77	109.14	
				SISO B	29.79	32.79	1901.08	952.80	21.51	21.51	282.49	141.58	
		7	2442	SISO A	25.01	28.01	632.41	316.96	21.11	21.11	257.63	129.12	
				SISO B	25.49	28.49	706.32	354.00	22.31	22.31	339.63	170.22	
		11	2462	SISO A	24.05	27.05	506.99	254.10	20.82	20.82	240.99	120.78	
				SISO B	24.95	27.95	623.73	312.61	21.87	21.87	306.90	153.82	
	12	2467	SISO A	25.59	28.59	722.77	362.24	17.24	17.24	105.68	52.97		
			SISO B	27.38	30.38	1091.44	547.02	19.07	19.07	161.06	80.72		
	13	2472	SISO A	21.64	24.64	291.07	145.88	13.59	13.59	45.60	22.86		
			SISO B	22.94	25.94	392.64	196.79	14.85	14.85	60.95	30.55		
	HT8	1	2412	MIMO A	24.55	27.55	568.85	285.10	19.25	19.25	167.88	84.14	
				MIMO B	25.61	28.61	726.11	363.92	20.49	20.49	223.36	111.94	
				Combined A+B	28.12	31.12	1294.96	649.02	22.92	22.92	391.24	196.08	
			7	2442	MIMO A	24.06	27.06	508.16	254.68	20.69	20.69	233.88	117.22
					MIMO B	25.34	28.34	682.34	341.98	21.82	21.82	303.39	152.05
					Combined A+B	27.76	30.76	1190.50	596.66	24.30	24.30	537.27	269.27
		11	2462	MIMO A	24.09	27.09	511.68	256.45	20.41	20.41	219.28	109.90	
				MIMO B	25.37	28.37	687.07	344.35	20.36	20.36	216.77	108.64	
Combined A+B				27.79	30.79	1198.75	600.80	23.40	23.40	436.05	218.54		
12		2467	MIMO A	23.47	26.47	443.61	222.33	15.12	15.12	64.86	32.51		
			MIMO B	24.85	27.85	609.54	305.49	16.36	16.36	86.30	43.25		
			Combined A+B	27.22	30.22	1053.15	527.82	18.79	18.79	151.16	75.76		
13	2472	MIMO A	21.26	24.26	266.69	133.66	13.20	13.20	41.69	20.89			
		MIMO B	22.89	25.89	388.15	194.54	14.45	14.45	55.59	27.86			
		Combined A+B	25.16	28.16	654.84	328.20	16.88	16.88	97.28	48.75			
802.11n40	MCS0	3	2422	SISO A	28.14	31.14	1300.17	651.63	19.69	19.69	185.78	93.11	
				SISO B	29.20	32.20	1659.59	831.76	20.78	20.78	238.78	119.67	
		7	2442	SISO A	28.23	31.23	1327.39	665.27	19.80	19.80	190.55	95.50	
				SISO B	29.25	32.25	1678.80	841.40	20.83	20.83	241.55	121.06	
		9	2452	SISO A	28.18	31.18	1312.20	657.66	19.70	19.70	186.21	93.33	
				SISO B	28.32	31.32	1355.19	679.20	19.86	19.86	193.20	96.83	
	10	2457	SISO A	24.17	27.17	521.19	261.22	15.94	15.94	78.34	39.26		
			SISO B	25.21	28.21	662.22	331.89	16.97	16.97	99.31	49.77		
	11	2462	SISO A	22.45	25.45	350.75	175.79	14.28	14.28	53.46	26.79		
			SISO B	23.65	26.65	462.38	231.74	15.47	15.47	70.31	35.24		
	HT8	3	2422	MIMO A	25.09	28.09	644.17	322.85	18.58	18.58	143.88	72.11	
				MIMO B	24.71	27.71	590.20	295.80	18.35	18.35	136.46	68.39	
				Combined A+B	27.91	30.91	1234.37	618.65	21.48	21.48	280.34	140.50	
			7	2442	MIMO A	24.89	27.89	615.18	308.32	19.41	19.41	174.18	87.30
					MIMO B	25.06	28.06	639.73	320.63	19.54	19.54	179.47	89.95
					Combined A+B	27.99	30.99	1254.91	628.95	22.49	22.49	353.65	177.25
		9	2452	MIMO A	24.85	27.85	609.54	305.49	19.27	19.27	168.66	84.53	
				MIMO B	25.09	28.09	644.17	322.85	19.22	19.22	166.72	83.56	
Combined A+B				27.98	30.98	1253.71	628.34	22.26	22.26	335.38	168.09		
10		2457	MIMO A	21.77	24.77	299.92	150.31	13.54	13.54	45.08	22.59		
			MIMO B	22.47	25.47	352.37	176.60	13.97	13.97	49.77	24.95		
			Combined A+B	25.14	28.14	652.29	326.92	16.77	16.77	94.86	47.54		
11	2462	MIMO A	21.06	24.06	254.68	127.64	12.88	12.88	38.73	19.41			
		MIMO B	23.42	26.42	438.53	219.79	14.79	14.79	60.12	30.13			
		Combined A+B	25.41	28.41	693.21	347.43	16.95	16.95	98.84	49.54			

* Duty cycle compensated

Mode	Rate	# Ch	Freq [MHz]	Antenna	RU config	Meas Peak Cond.Power [dBm]	EIRP [dBm]	EIRP [mW]	Peak Cond.Power [mW]	Meas. Avg Cond.Power [dBm]	Max. Avg Cond.Power* [dBm]	EIRP [mW]	Avg Cond.Power [mW]	
802.11ax/be20	MCS0	1	2412	SISO A	Full	29.26	32.26	1682.67	843.33	20.01	20.01	199.99	100.23	
					26/0	29.09	32.09	1618.08	810.96	20.95	20.95	248.31	124.45	
					52/37	29.84	32.84	1923.09	963.83	20.86	20.86	243.22	121.90	
				SISO B	106/53	29.88	32.88	1940.89	972.75	20.50	20.50	223.87	112.20	
					Full	24.38	27.38	547.02	274.16	21.65	21.65	291.74	146.22	
					26/0	24.62	27.62	578.10	289.73	22.27	22.27	336.51	168.66	
				MIMO A	52/37	24.38	27.38	547.02	274.16	22.47	22.47	352.37	176.60	
					106/53	24.55	27.55	568.85	285.10	22.45	22.45	350.75	175.79	
					Full	25.03	28.03	635.33	318.42	18.67	18.67	146.89	73.62	
				MIMO B	26/0	23.85	26.85	484.17	242.66	19.95	19.95	197.24	98.86	
					52/37	24.05	27.05	506.99	254.10	20.72	20.72	235.50	118.03	
					106/53	24.25	27.25	530.88	266.07	20.77	20.77	238.23	119.40	
		Combined A+B	Full	24.89	27.89	615.18	308.32	19.72	19.72	187.07	93.76			
			26/0	25.05	28.05	638.26	319.89	21.63	21.63	290.40	145.55			
			52/37	24.81	27.81	603.95	302.69	21.85	21.85	305.49	153.11			
		SISO A	106/53	25.06	28.06	639.73	320.63	20.74	20.74	236.59	118.58			
			Full	27.97	30.97	1250.51	626.74	22.24	22.24	333.96	167.38			
			26/0	27.50	30.50	1122.44	562.55	23.88	23.88	487.64	244.40			
		SISO B	52/37	27.46	30.46	1110.94	556.79	24.33	24.33	541.00	271.14			
			106/53	27.68	30.68	1170.62	586.70	23.77	23.77	474.82	237.98			
			Full	29.80	32.80	1905.46	954.99	20.37	20.37	217.27	108.89			
		7	2442	MIMO A	SISO A	Full	29.80	32.80	1905.46	954.99	20.37	20.37	217.27	108.89
					SISO B	Full	25.02	28.02	633.87	317.69	21.98	21.98	314.77	157.76
					MIMO A	Full	24.55	27.55	568.85	285.10	20.59	20.59	228.56	114.55
					MIMO B	Full	24.13	27.13	516.42	258.82	21.84	21.84	304.79	152.76
					Combined A+B	Full	27.36	30.36	1085.27	543.92	24.27	24.27	533.35	267.31
		11	2462	MIMO A	SISO A	Full	29.43	32.43	1749.85	877.00	20.25	20.25	211.35	105.93
					SISO B	Full	25.11	28.11	647.14	324.34	21.53	21.53	283.79	142.23
					MIMO A	Full	25.51	28.51	709.58	355.63	19.41	19.41	174.18	87.30
					MIMO B	Full	24.72	27.72	591.56	296.48	19.71	19.71	186.64	93.54
					Combined A+B	Full	28.14	31.14	1301.14	652.11	22.57	22.57	360.82	180.84
		12	2467	MIMO A	SISO A	Full	26.32	29.32	855.07	428.55	17.12	17.12	102.80	51.52
					SISO B	Full	27.03	30.03	1006.93	504.66	17.92	17.92	123.59	61.94
					MIMO A	Full	23.64	26.64	461.32	231.21	14.52	14.52	56.49	28.31
					MIMO B	Full	24.43	27.43	553.35	277.33	15.27	15.27	67.14	33.65
					Combined A+B	Full	27.06	30.06	1014.67	508.54	17.92	17.92	123.64	61.97
		13	2472	SISO A	SISO A	Full	23.30	26.30	426.58	213.80	13.77	13.77	47.53	23.82
					26/8	22.62	25.62	364.75	182.81	12.12	12.12	32.51	16.29	
					52/40	22.88	25.88	387.26	194.09	12.54	12.54	35.81	17.95	
					106/54	23.05	26.05	402.72	201.84	12.72	12.72	37.33	18.71	
					Full	24.26	27.26	532.11	266.69	14.64	14.64	58.08	29.11	
					26/8	23.82	26.82	480.84	240.99	13.43	13.43	43.95	22.03	
				SISO B	52/40	24.03	27.03	504.66	252.93	13.83	13.83	48.19	24.15	
					106/54	23.88	26.88	487.53	244.34	13.79	13.79	47.75	23.93	
					Full	22.17	25.17	328.85	164.82	12.64	12.64	36.64	18.37	
					26/8	22.21	25.21	331.89	166.34	11.70	11.70	29.51	14.79	
					52/40	22.10	25.10	323.59	162.18	11.63	11.63	29.04	14.55	
					106/54	21.55	24.55	285.10	142.89	11.36	11.36	27.29	13.68	
MIMO A	Full			22.99	25.99	397.19	199.07	13.44	13.44	44.06	22.08			
	26/8			21.72	24.72	296.48	148.59	11.49	11.49	28.12	14.09			
	52/40			20.98	23.98	250.03	125.31	10.94	10.94	24.77	12.42			
	106/54			21.25	24.25	266.07	133.35	11.18	11.18	26.18	13.12			
	Full			25.61	28.61	726.04	363.88	16.07	16.07	80.70	40.45			
	26/8			24.98	27.98	628.38	314.93	14.61	14.61	57.63	28.88			
MIMO B	52/40	24.59	27.59	573.63	287.50	14.31	14.31	53.81	26.97					
	106/54	24.41	27.41	551.17	276.24	14.28	14.28	53.47	26.80					

* Duty cycle compensated

Mode	Rate	# Ch	Freq [MHz]	Antenna	RU config	Meas Peak Cond.Power [dBm]	EIRP [dBm]	EIRP [mW]	Peak Cond.Power [mW]	Meas. Avg Cond.Power [dBm]	Max. Avg Cond.Power* [dBm]	EIRP [mW]	Avg Cond.Power [mW]
802.11ax/be40	MCS0	3	2422	SISO A	Full	28.71	31.71	1482.52	743.02	19.34	19.34	171.40	85.90
					242/61	28.88	31.88	1541.70	772.68	19.73	19.73	187.50	93.97
				SISO B	Full	29.93	32.93	1963.36	984.01	20.59	20.59	228.56	114.55
					242/61	24.79	27.79	601.17	301.30	21.43	21.43	277.33	139.00
				MIMO A	Full	24.81	27.81	603.95	302.69	18.46	18.46	139.96	70.15
					242/61	25.03	28.03	635.33	318.42	18.66	18.66	146.55	73.45
		MIMO B	Full	24.77	27.77	598.41	299.92	18.29	18.29	134.59	67.45		
			242/61	24.89	27.89	615.18	308.32	19.78	19.78	189.67	95.06		
		Combined A+B	Full	27.80	30.80	1202.36	602.61	21.39	21.39	274.54	137.60		
			242/61	27.97	30.97	1250.51	626.74	22.27	22.27	336.23	168.51		
		7	2442	SISO A	Full	29.14	32.14	1636.82	820.35	19.70	19.70	186.21	93.33
					Full	24.75	27.75	595.66	298.54	20.89	20.89	244.91	122.74
				MIMO A	Full	25.04	28.04	636.80	319.15	19.04	19.04	159.96	80.17
					Full	25.03	28.03	635.33	318.42	19.86	19.86	193.20	96.83
				Combined A+B	Full	28.05	31.05	1272.13	637.57	22.48	22.48	353.15	177.00
		9	2452	SISO A	Full	28.84	31.84	1527.57	765.60	19.40	19.40	173.78	87.10
					Full	29.13	32.13	1633.05	818.46	19.80	19.80	190.55	95.50
				MIMO A	Full	24.77	27.77	598.41	299.92	18.72	18.72	148.59	74.47
					Full	25.04	28.04	636.80	319.15	18.66	18.66	146.55	73.45
				Combined A+B	Full	27.92	30.92	1235.21	619.07	21.70	21.70	295.15	147.92
		10	2457	SISO A	Full	24.79	27.79	601.17	301.30	15.34	15.34	68.23	34.20
					Full	25.07	28.07	641.21	321.37	15.60	15.60	72.44	36.31
				MIMO A	Full	22.47	25.47	352.37	176.60	13.00	13.00	39.81	19.95
					Full	22.23	25.23	333.43	167.11	12.96	12.96	39.45	19.77
				Combined A+B	Full	25.36	28.36	685.80	343.71	15.99	15.99	79.26	39.72
		11	2462	SISO A	Full	23.82	26.82	480.84	240.99	14.23	14.23	52.84	26.49
					242/62	22.27	25.27	336.51	168.66	12.70	12.70	37.15	18.62
				SISO B	Full	24.85	27.85	609.54	305.49	15.34	15.34	68.23	34.20
					242/62	23.38	26.38	434.51	217.77	13.98	13.98	49.89	25.00
				MIMO A	Full	22.72	25.72	373.25	187.07	13.23	13.23	41.98	21.04
					242/62	21.08	24.08	255.86	128.23	11.64	11.64	29.11	14.59
				MIMO B	Full	24.50	27.50	562.34	281.84	14.85	14.85	60.95	30.55
					242/62	22.97	25.97	395.37	198.15	13.48	13.48	44.46	22.28
		Combined A+B	Full	26.71	29.71	935.59	468.91	17.13	17.13	102.93	51.59		
		242/62	25.14	28.14	651.23	326.39	15.67	15.67	73.57	36.87			

* Duty cycle compensated

B.2.3 Power Spectral Density

Test limits

FCC part	RSS part	Limits
15.247 (e)	RSS-247 Clause 5.2 (b)	For digitally modulated systems, the power spectral density conducted from the intentional radiator to the antenna shall not be greater than 8 dBm in any 3 kHz band during any time interval of continuous transmission. This power spectral density shall be determined in accordance with the provisions of paragraph (b) of this section. The same method of determining the conducted output power shall be used to determine the power spectral density.

Test procedure

The peak power spectral density level in the fundamental emission was measured using the *Method PKPSD (peak PSD)* according to section 11.10.2 of ANSI C63.10-2013.

For MIMO mode, the *Measure and add $10 \log(N_{ANT})$ dB*, (where N_{ANT} is the number of outputs) technique was used according to the *Guidance for Emission Testing of Transmitters with Multiple Outputs in the Same Band FCC OET KDB 662911 D01 Multiple Transmitter Output*.

With this technique, spectrum measurements are performed at each output of the device, and the quantity $10 \log(N_{ANT})$ dB is added to each spectrum value before comparing to the emission limit. Number of outputs = 2.

The conducted setup shown in section *Test & System Description* was used to measure the power spectral density. The antenna terminal of the EUT is connected to the spectrum through an attenuator, and the spectrum analyzer reading is compensated to include the RF path loss.

Results tables

Mode	Rate	Channel	Freq [MHz]	Antenna	PSD Peak [dBm/3kHz]	MIMO Combined +10·log(N _{ant}) [dBm/3kHz]
802.11b	1Mbps	1	2412	SISO A	0.49	N/A
				SISO B	0.53	N/A
		7	2442	SISO A	0.86	N/A
				SISO B	1.90	N/A
		11	2462	SISO A	0.84	N/A
				SISO B	1.97	N/A
		12	2467	SISO A	-0.99	N/A
				SISO B	-0.15	N/A
		13	2472	SISO A	-3.08	N/A
				SISO B	-2.57	N/A
802.11g	6Mbps	1	2412	SISO A	-2.48	N/A
				SISO B	-1.22	N/A
		7	2442	SISO A	-2.04	N/A
				SISO B	-0.76	N/A
		11	2462	SISO A	-2.61	N/A
				SISO B	-2.18	N/A
		12	2467	SISO A	-5.16	N/A
				SISO B	-5.75	N/A
		13	2472	SISO A	-10.88	N/A
				SISO B	-9.86	N/A
802.11n20	MCS0	1	2412	SISO A	-2.68	N/A
				SISO B	-2.50	N/A
		7	2442	SISO A	-2.56	N/A
				SISO B	-1.66	N/A
		11	2462	SISO A	-2.55	N/A
				SISO B	-1.60	N/A
		12	2467	SISO A	-5.96	N/A
				SISO B	-4.47	N/A
		13	2472	SISO A	-10.45	N/A
				SISO B	-9.45	N/A
	HT8	1	2412	MIMO A	-3.79	-0.78
				MIMO B	-3.36	-0.35
		7	2442	MIMO A	-1.75	1.26
				MIMO B	-2.49	0.52
		11	2462	MIMO A	-2.86	0.15
				MIMO B	-3.89	-0.88
		12	2467	MIMO A	-8.32	-5.31
				MIMO B	-7.65	-4.64
		13	2472	MIMO A	-11.00	-7.99
				MIMO B	-10.32	-7.31
802.11n40	MCS0	3	2422	SISO A	-7.15	N/A
				SISO B	-5.72	N/A
		7	2442	SISO A	-7.16	N/A
				SISO B	-5.00	N/A
		9	2452	SISO A	-6.97	N/A
				SISO B	-7.44	N/A
	10	2457	SISO A	-11.23	N/A	
			SISO B	-9.45	N/A	
	11	2462	SISO A	-13.11	N/A	
			SISO B	-11.53	N/A	
	HT8	3	2422	MIMO A	-8.14	-5.13
				MIMO B	-7.80	-4.79
		7	2442	MIMO A	-7.42	-4.41
				MIMO B	-7.93	-4.92
		9	2452	MIMO A	-7.49	-4.48
				MIMO B	-7.83	-4.82
	10	2457	MIMO A	-13.27	-10.26	
			MIMO B	-13.35	-10.34	
11	2462	MIMO A	-14.92	-11.91		
		MIMO B	-12.65	-9.64		

Mode	Rate	#Ch	Freq[MHz]	Antenna	RU config.	PSD Peak [dBm/3kHz]	MIMO Combined +10·log(N _{ant}) [dBm/3kHz]
802.11ax/be20	MCS0	1	2412	SISO A	Full	-3.28	N/A
					26/0	4.56	N/A
					52/37	1.60	N/A
					106/53	-1.77	N/A
				SISO B	Full	-1.59	N/A
					26/0	6.67	N/A
					52/37	3.45	N/A
					106/53	0.07	N/A
				MIMO A	Full	-6.13	-3.12
					26/0	3.77	6.78
					52/37	1.58	4.59
					106/53	-0.25	2.76
		MIMO B	Full	-5.02	-2.01		
			26/0	4.98	7.99		
			52/37	2.62	5.63		
			106/53	-0.66	2.35		
		7	2442	SISO A	Full	-3.74	N/A
					Full	-2.63	N/A
				MIMO A	Full	-3.93	-0.92
					Full	-2.26	0.75
		11	2462	SISO A	Full	-4.51	N/A
					Full	-3.08	N/A
				MIMO A	Full	-4.24	-1.23
					Full	-4.01	-1.00
		12	2467	SISO A	Full	-7.38	N/A
					Full	-6.39	N/A
				MIMO A	Full	-9.58	-6.57
					Full	-8.86	-5.85
		13	2472	SISO A	Full	-11.64	N/A
					26/8	-2.98	N/A
					52/40	-5.47	N/A
					106/54	-8.05	N/A
				SISO B	Full	-11.10	N/A
					26/8	-2.69	N/A
					52/40	-5.71	N/A
					106/54	-8.05	N/A
				MIMO A	Full	-11.86	-8.85
					26/8	-4.38	-1.37
					52/40	-7.12	-4.11
					106/54	-10.15	-7.14
				MIMO B	Full	-11.04	-8.03
					26/8	-5.44	-2.43
					52/40	-7.30	-4.29
					106/54	-10.85	-7.84

Mode	Rate	#Ch	Freq[MHz]	Antenna	RU config.	PSD Peak [dBm/3kHz]	MIMO Combined +10·log(N _{ant}) [dBm/3kHz]
802.11ax/be40	MCS0	3	2422	SISO A	Full	-8.26	N/A
					242/61	-4.86	N/A
				SISO B	Full	-6.76	N/A
					242/61	-3.02	N/A
				MIMO A	Full	-8.79	-5.78
					242/61	-5.84	-2.83
				MIMO B	Full	-9.56	-6.55
					242/61	-5.15	-2.14
		7	2442	SISO A	Full	-7.52	N/A
					Full	-6.86	N/A
				MIMO A	Full	-8.25	-5.24
					Full	-7.81	-4.80
		9	2452	SISO A	Full	-7.89	N/A
					Full	-8.35	N/A
				MIMO A	Full	-8.79	-5.78
					Full	-8.98	-5.97
		10	2457	SISO A	Full	-12.27	N/A
					Full	-12.77	N/A
				MIMO A	Full	-13.97	-10.96
					Full	-14.29	-11.28
		11	2462	SISO A	Full	-14.05	N/A
					242/62	-12.57	N/A
				SISO B	Full	-13.47	N/A
					242/62	-11.37	N/A
				MIMO A	Full	-14.91	-11.90
					242/62	-14.38	-11.37
		MIMO B	Full	-12.23	-9.22		
			242/62	-11.88	-8.87		

B.2.4 Out-of-band emission (conducted)

Test Limits

FCC part	RSS part	Limits																				
15.247 (d)	RSS-247 Clause 5.5	In any 100 kHz bandwidth outside the frequency band in which the spread spectrum or digitally modulated intentional radiator is operating, the radio frequency power that is produced by the intentional radiator shall be at least 20 dB below that in the 100 kHz bandwidth within the band that contains the highest level of the desired power, based on either an RF conducted or a radiated measurement, provided the transmitter demonstrates compliance with the peak conducted power limits.																				
15.209	RSS-Gen A1 Clause 8.9	<p>Radiated emissions which fall in the restricted bands, as defined in §15.205(a), must also comply with the radiated emission limits specified in §15.209(a):</p> <table border="1"> <thead> <tr> <th>Freq Range (MHz)</th> <th>Field Strength (μV/m)</th> <th>Field Strength (dBμV/m)</th> <th>Meas. Distance (m)</th> </tr> </thead> <tbody> <tr> <td>30-88</td> <td>100</td> <td>40</td> <td>3</td> </tr> <tr> <td>88-216</td> <td>150</td> <td>43.5</td> <td>3</td> </tr> <tr> <td>216-960</td> <td>200</td> <td>46</td> <td>3</td> </tr> <tr> <td>Above 960</td> <td>500</td> <td>54</td> <td>3</td> </tr> </tbody> </table> <p>The emission limits shown in the above table are based on measurements employing CISPR quasi-peak detector except for the frequency bands 9-90 kHz, 110-490 kHz and above 1000 MHz. Radiated emission limits in these three bands are based on measurements employing an average detector. For average radiated emission measurements above 1000 MHz, there is also a limit specified when measuring with peak detector function, corresponding to 20 dB above the indicated values in the table.</p>	Freq Range (MHz)	Field Strength (μV/m)	Field Strength (dBμV/m)	Meas. Distance (m)	30-88	100	40	3	88-216	150	43.5	3	216-960	200	46	3	Above 960	500	54	3
Freq Range (MHz)	Field Strength (μV/m)	Field Strength (dBμV/m)	Meas. Distance (m)																			
30-88	100	40	3																			
88-216	150	43.5	3																			
216-960	200	46	3																			
Above 960	500	54	3																			

Test procedure

The lower band edge falling in restricted bands was measured using the primary method according to section 11.12.2.5.2 & 11.12.2.4 of ANSI C63.10-2013.

The upper band edge was measured using the following methods:

- Integration Method according to 11.13.3 of ANSI C63.10-2013
- Primary Method according 11.12.2.5.2 & 11.12.2.4 of ANSI C63.10-2013.

In case of band edge measurements falling in restricted bands, the declared antenna gain is also compensated in the graph.

For band edge measurements falling in restricted bands, the following limits in dBm were applied for the average detector after the conversion from the limits detailed above in dBμV/m, according to FCC 47 CFR part 15 - Subpart C – §15.209(a). The limits in dBm for peak detector are 20dB above the indicated values in the table.

§15.209(a)			Converted values	
Freq Range (MHz)	Distance (m)	Field strength (microvolts/meter)	Field strength (dB microvolts/meter)	Power (dBm)
Above 960	3	500	54.0	-41.2

The conducted setup shown in section *Test & System Description* was used to measure the out-of-band emissions. The antenna terminal of the EUT is connected to the spectrum through an attenuator, and the spectrum analyzer reading is compensated to include the RF path loss.

See Section B.2.6 for the screenshot results.

B.2.5 Radiated spurious emission

Standard references

FCC part	RSS part	Limits																				
<p>15.247 (d) 15.209</p>	<p>RSS-247 Clause 5.5 RSS-Gen A1 Clause 8.9</p>	<p>Radiated emissions which fall in the restricted bands, as defined in §15.205(a), must also comply with the radiated emission limits specified in §15.209(a):</p>																				
		<table border="1"> <thead> <tr> <th data-bbox="564 495 762 555">Freq Range (MHz)</th> <th data-bbox="762 495 960 555">Field Strength ($\mu\text{V}/\text{m}$)</th> <th data-bbox="960 495 1158 555">Field Strength ($\text{dB}\mu\text{V}/\text{m}$)</th> <th data-bbox="1158 495 1353 555">Meas. Distance (m)</th> </tr> </thead> <tbody> <tr> <td data-bbox="564 555 762 584">30-88</td> <td data-bbox="762 555 960 584">100</td> <td data-bbox="960 555 1158 584">40</td> <td data-bbox="1158 555 1353 584">3</td> </tr> <tr> <td data-bbox="564 584 762 613">88-216</td> <td data-bbox="762 584 960 613">150</td> <td data-bbox="960 584 1158 613">43.5</td> <td data-bbox="1158 584 1353 613">3</td> </tr> <tr> <td data-bbox="564 613 762 642">216-960</td> <td data-bbox="762 613 960 642">200</td> <td data-bbox="960 613 1158 642">46</td> <td data-bbox="1158 613 1353 642">3</td> </tr> <tr> <td data-bbox="564 642 762 672">Above 960</td> <td data-bbox="762 642 960 672">500</td> <td data-bbox="960 642 1158 672">54</td> <td data-bbox="1158 642 1353 672">3</td> </tr> </tbody> </table>	Freq Range (MHz)	Field Strength ($\mu\text{V}/\text{m}$)	Field Strength ($\text{dB}\mu\text{V}/\text{m}$)	Meas. Distance (m)	30-88	100	40	3	88-216	150	43.5	3	216-960	200	46	3	Above 960	500	54	3
Freq Range (MHz)	Field Strength ($\mu\text{V}/\text{m}$)	Field Strength ($\text{dB}\mu\text{V}/\text{m}$)	Meas. Distance (m)																			
30-88	100	40	3																			
88-216	150	43.5	3																			
216-960	200	46	3																			
Above 960	500	54	3																			

Test procedure

The radiated setups shown in section *Test & System Description* were used to measure the radiated spurious emissions. Depending of the frequency range and bands being tested, different antennas and filters were used. The final measurement is done by varying the antenna height from 1 to 4 meters, the EUT azimuth over 360° and for both Vertical and Horizontal polarizations.

The radiated spurious emissions were measured on the worst case configuration selected from the chapter B.2.2 and using the lowest, middle and highest channels.

Test Results

Radiated spurious - 30 MHz – 1 GHz**Radiated Spurious – All modes**

Frequency	Level	Detector	Limit	Margin	Polar
MHz	dB μ V/m	---	dB μ V/m	dB	---
39.0	33.2	Quasi-Peak	40.0	6.8	V
51.3	38.3	Quasi-Peak	40.0	1.7	V
51.7	37.1	Quasi-Peak	40.0	2.9	V

Note 1: The spurious signals detected do not depend on either the operating channel or the modulation mode.

1 GHz – 26 GHz, 802.11b, 1Mbps, Chain A**Radiated Spurious – CH1**

Frequency	Level	Detector	Limit	Margin	Polar
MHz	dB μ V/m	---	dB μ V/m	dB	---
4582.9	50.7	Peak	74.0	23.3	V
4582.9	40.6	Average	54.0	13.4	H
12058.5	38.6	Average	54.0	15.3	H
12060.5	46.2	Peak	74.0	27.8	H

Radiated Spurious – CH7

Frequency	Level	Detector	Limit	Margin	Polar
MHz	dB μ V/m	---	dB μ V/m	dB	---
3974.9	51.4	Peak	74.0	22.6	V
3974.9	40.7	Average	54.0	13.3	H
12651.5	42.8	Peak	74.0	31.2	V
12651.8	36.1	Average	54.0	17.9	H
25346.5	42.7	Average	54.0	11.3	V
25346.8	48.8	Peak	74.0	25.2	V

Radiated Spurious – CH11

Frequency	Level	Detector	Limit	Margin	Polar
MHz	dB μ V/m	---	dB μ V/m	dB	---
3980.3	50.3	Peak	74.0	23.7	H
3981.4	40.7	Average	54.0	13.3	H
12312.0	45.0	Peak	74.0	29.1	H
12312.0	36.3	Average	54.0	17.7	H
25395.2	49.7	Peak	74.0	24.3	V
25395.2	42.9	Average	54.0	11.1	V

1 GHz – 26.5 GHz, 802.11b, 1Mbps, Chain B

Radiated Spurious – CH1

Frequency	Level	Detector	Limit	Margin	Polar
MHz	dB μ V/m	---	dB μ V/m	dB	---
4823.4	51.2	Peak	74.0	22.8	V
4823.9	43.4	Average	54.0	10.6	V
14471.8	45.4	Peak	74.0	28.6	V
14472.0	39.3	Average	54.0	14.7	V
16881.2	41.8	Average	54.0	12.2	V
16882.8	49.2	Peak	74.0	24.8	V
24119.8	52.3	Peak	74.0	21.7	V
24120.2	50.8	Average	54.0	3.2	V

Radiated Spurious – CH7

Frequency	Level	Detector	Limit	Margin	Polar
MHz	dB μ V/m	---	dB μ V/m	dB	---
4884.2	51.6	Peak	74.0	22.4	V
4884.2	43.3	Average	54.0	10.7	V
12207.2	43.9	Peak	74.0	30.1	V
12207.2	38.6	Average	54.0	15.4	V
19535.8	49.7	Peak	74.0	24.3	V
19536.0	44.3	Average	54.0	9.7	V
24420.0	53.7	Peak	74.0	20.3	V
24420.2	49.6	Average	54.0	4.4	V

Radiated Spurious – CH11

Frequency	Level	Detector	Limit	Margin	Polar
MHz	dBµV/m	---	dBµV/m	dB	---
3968.4	50.1	Peak	74.0	23.9	V
3970.5	40.8	Average	54.0	13.2	V
12308.8	45.4	Peak	74.0	28.6	V
12308.8	38.0	Average	54.0	16.0	V
19695.8	49.4	Peak	74.0	24.6	V
19696.0	44.9	Average	54.0	9.1	V
24620.0	50.9	Peak	74.0	23.1	V
24620.0	50.3	Average	54.0	3.7	V

1 GHz – 26.5 GHz, 802.11g, 6Mbps, Chain A

Radiated Spurious – CH1

Frequency	Level	Detector	Limit	Margin	Polar
MHz	dB μ V/m	---	dB μ V/m	dB	---
3990.1	51.7	Peak	74.0	22.3	V
3990.1	41.0	Average	54.0	13.0	V
12636.8	45.0	Peak	74.0	29.0	H
12637.2	36.8	Average	54.0	17.2	H
25354.5	50.0	Peak	74.0	24.1	H
25354.5	42.6	Average	54.0	11.4	V

Radiated Spurious – CH7

Frequency	Level	Detector	Limit	Margin	Polar
MHz	dB μ V/m	---	dB μ V/m	dB	---
6237.0	53.5	Peak	74.0	20.4	V
6238.6	44.2	Average	54.0	9.8	H
25892.0	48.8	Peak	74.0	25.2	H
25892.0	42.5	Average	54.0	11.5	H

Radiated Spurious – CH11

Frequency	Level	Detector	Limit	Margin	Polar
MHz	dB μ V/m	---	dB μ V/m	dB	---
7463.3	44.1	Average	54.0	9.9	H
7464.4	53.3	Peak	74.0	20.7	V
25420.8	51.0	Peak	74.0	23.1	H
25421.5	43.0	Average	54.0	11.1	H

1 GHz – 26.5 GHz, 802.11g, 6Mbps, Chain B

Radiated Spurious – CH1

Frequency	Level	Detector	Limit	Margin	Polar
MHz	dB μ V/m	---	dB μ V/m	dB	---
6994.8	54.4	Peak	74.0	19.6	V
6994.8	44.4	Average	54.0	9.6	H
12050.0	43.7	Peak	74.0	30.3	V
12050.0	36.9	Average	54.0	17.1	H
24937.2	48.8	Peak	74.0	25.2	H
24937.2	42.6	Average	54.0	11.4	V

Radiated Spurious – CH7

Frequency	Level	Detector	Limit	Margin	Polar
MHz	dB μ V/m	---	dB μ V/m	dB	---
7651.1	53.6	Peak	74.0	20.4	V
7652.2	44.1	Average	54.0	9.9	V
25375.2	50.8	Peak	74.0	23.2	V
25375.2	42.8	Average	54.0	11.2	V

Radiated Spurious – CH11

Frequency	Level	Detector	Limit	Margin	Polar
MHz	dB μ V/m	---	dB μ V/m	dB	---
7292.3	53.6	Peak	74.0	20.4	H
7293.4	44.1	Average	54.0	9.9	H
25577.8	49.2	Peak	74.0	24.8	V
25577.8	42.2	Average	54.0	11.8	V

1 GHz – 26.5 GHz, 802.11n20, MCS0, Chain A

Radiated Spurious – CH1

Frequency	Level	Detector	Limit	Margin	Polar
MHz	dBμV/m	---	dBμV/m	dB	---
10025.0	56.7	Peak	74.0	17.3	H
10025.0	48.0	Average	54.0	6.0	V
12063.2	45.2	Peak	74.0	28.8	V
12063.2	36.5	Average	54.0	17.5	H
25374.8	50.1	Peak	74.0	23.9	V
25374.8	42.5	Average	54.0	11.5	H

Radiated Spurious – CH7

Frequency	Level	Detector	Limit	Margin	Polar
MHz	dBμV/m	---	dBμV/m	dB	---
10019.6	56.0	Peak	74.0	18.0	H
10019.6	47.8	Average	54.0	6.2	H
25407.0	42.7	Average	54.0	11.3	H
25407.0	50.1	Peak	74.0	23.9	V

Radiated Spurious – CH11

Frequency	Level	Detector	Limit	Margin	Polar
MHz	dBμV/m	---	dBμV/m	dB	---
10096.7	56.5	Peak	74.0	17.5	H
10097.2	48.0	Average	54.0	6.0	H
12597.8	43.7	Peak	74.0	30.3	V
12597.8	36.3	Average	54.0	17.7	H
25377.8	50.1	Peak	74.0	23.9	H
25377.8	42.2	Average	54.0	11.8	H

1 GHz – 26.5 GHz, 802.11n20, MCS0, Chain B

Radiated Spurious – CH1

Frequency	Level	Detector	Limit	Margin	Polar
MHz	dB μ V/m	---	dB μ V/m	dB	---
10031.5	56.7	Peak	74.0	17.3	H
10031.5	47.8	Average	54.0	6.2	V
12058.2	43.5	Peak	74.0	30.5	V
12058.2	37.2	Average	54.0	16.8	H
25400.0	50.4	Peak	74.0	23.6	H
25400.8	42.3	Average	54.0	11.7	V

Radiated Spurious – CH7

Frequency	Level	Detector	Limit	Margin	Polar
MHz	dB μ V/m	---	dB μ V/m	dB	---
10061.4	56.4	Peak	74.0	17.6	V
10061.4	47.7	Average	54.0	6.3	H
25401.8	50.1	Peak	74.0	23.9	H
25402.5	42.3	Average	54.0	11.7	V

Radiated Spurious – CH11

Frequency	Level	Detector	Limit	Margin	Polar
MHz	dB μ V/m	---	dB μ V/m	dB	---
10015.3	58.1	Peak	74.0	15.8	H
10015.3	47.8	Average	54.0	6.2	H
12672.2	45.5	Peak	74.0	28.5	H
12672.2	36.5	Average	54.0	17.5	H
25227.5	49.4	Peak	74.0	24.6	V
25227.8	42.2	Average	54.0	11.8	V

1 GHz – 26.5 GHz, 802.11n20, MCS0, Chain A+B

Radiated Spurious – CH1

Frequency	Level	Detector	Limit	Margin	Polar
MHz	dB μ V/m	---	dB μ V/m	dB	---
10090.7	57.4	Peak	74.0	16.6	V
10090.7	47.7	Average	54.0	6.3	V
12057.2	36.8	Average	54.0	17.2	V
12057.5	43.9	Peak	74.0	30.1	H
24495.8	49.2	Peak	74.0	24.8	H
24495.8	42.4	Average	54.0	11.6	H

Radiated Spurious – CH7

Frequency	Level	Detector	Limit	Margin	Polar
MHz	dB μ V/m	---	dB μ V/m	dB	---
10007.7	55.8	Peak	74.0	18.2	V
10007.7	48.0	Average	54.0	6.0	V
24426.5	51.0	Peak	74.0	23.0	V
24426.5	43.1	Average	54.0	10.9	V

Radiated Spurious – CH11

Frequency	Level	Detector	Limit	Margin	Polar
MHz	dB μ V/m	---	dB μ V/m	dB	---
10045.1	56.9	Peak	74.0	17.1	V
10045.1	47.8	Average	54.0	6.2	V
12602.8	44.9	Peak	74.0	29.1	H
12603.0	36.0	Average	54.0	18.0	H
25393.0	49.9	Peak	74.0	24.1	V
25393.5	42.2	Average	54.0	11.8	V

1 GHz – 26.5 GHz, 802.11ax/be20, MCS0, Chain A

Radiated Spurious – CH1

Frequency	Level	Detector	Limit	Margin	Polar
MHz	dB μ V/m	---	dB μ V/m	dB	---
7531.7	55.0	Peak	74.0	19.0	V
7531.7	44.8	Average	54.0	9.2	V
12016.5	49.4	Peak	74.0	24.6	H
12017.5	40.1	Average	54.0	13.9	H

Radiated Spurious – CH7

Frequency	Level	Detector	Limit	Margin	Polar
MHz	dB μ V/m	---	dB μ V/m	dB	---
4861.4	50.4	Peak	74.0	23.6	H
4863.0	41.3	Average	54.0	12.7	V
25363.0	49.6	Peak	74.0	24.4	V
25363.0	42.7	Average	54.0	11.3	V

Radiated Spurious – CH11

Frequency	Level	Detector	Limit	Margin	Polar
MHz	dB μ V/m	---	dB μ V/m	dB	---
4988.4	50.8	Peak	74.0	23.2	V
4988.4	41.0	Average	54.0	13.0	H
25363.0	50.1	Peak	74.0	23.9	H
25363.0	42.5	Average	54.0	11.5	H

1 GHz – 26.5 GHz, 802.11ax/be20, MCS0, Chain B

Radiated Spurious – CH1

Frequency	Level	Detector	Limit	Margin	Polar
MHz	dB μ V/m	---	dB μ V/m	dB	---
4806.5	51.0	Peak	74.0	23.0	H
4806.5	41.8	Average	54.0	12.2	V
12016.2	42.5	Average	54.0	11.5	H
12016.2	50.8	Peak	74.0	23.2	H
24033.8	41.5	Average	54.0	12.6	V
24035.2	54.0	Peak	74.0	20.0	V

Radiated Spurious – CH7

Frequency	Level	Detector	Limit	Margin	Polar
MHz	dB μ V/m	---	dB μ V/m	dB	---
6981.8	52.8	Peak	74.0	21.2	H
6981.8	44.3	Average	54.0	9.7	H
12166.5	45.9	Peak	74.0	28.1	H
12166.5	38.3	Average	54.0	15.7	V
17031.5	49.3	Peak	74.0	24.7	V
17035.2	40.7	Average	54.0	13.3	V
24334.8	49.9	Peak	74.0	24.1	V
24335.0	42.2	Average	54.0	11.8	H

Radiated Spurious – CH11

Frequency	Level	Detector	Limit	Margin	Polar
MHz	dB μ V/m	---	dB μ V/m	dB	---
5010.1	50.5	Peak	74.0	23.5	H
5010.1	41.7	Average	54.0	12.3	H
12267.8	44.2	Peak	74.0	29.8	V
12267.8	37.9	Average	54.0	16.1	V

1 GHz – 26.5 GHz, 802.11ax/be20, MCS0, Chain A+B

Radiated Spurious – CH1

Frequency	Level	Detector	Limit	Margin	Polar
MHz	dB μ V/m	---	dB μ V/m	dB	---
6684.3	43.2	Average	54.0	10.8	H
6684.8	52.1	Peak	74.0	21.9	H
12016.2	42.4	Average	54.0	11.6	H
12016.5	51.8	Peak	74.0	22.2	H
24035.8	56.6	Peak	74.0	17.4	V
24035.8	41.7	Average	54.0	12.3	V

Radiated Spurious – CH7

Frequency	Level	Detector	Limit	Margin	Polar
MHz	dB μ V/m	---	dB μ V/m	dB	---
4520.5	49.6	Peak	74.0	24.4	H
4521.0	40.1	Average	54.0	13.8	V
12168.0	38.0	Average	54.0	16.0	V
12169.0	46.4	Peak	74.0	27.6	V
24334.5	52.0	Peak	74.0	22.0	V
24334.5	43.2	Average	54.0	10.8	V

Radiated Spurious – CH11

Frequency	Level	Detector	Limit	Margin	Polar
MHz	dB μ V/m	---	dB μ V/m	dB	---
4242.5	50.9	Peak	74.0	23.1	H
4251.7	41.3	Average	54.0	12.7	H
12267.0	46.7	Peak	74.0	27.3	V
12267.0	39.3	Average	54.0	14.7	V

1 GHz – 26.5 GHz, 802.11n40, MCS0, Chain A

Radiated Spurious – CH3F

Frequency	Level	Detector	Limit	Margin	Polar
MHz	dB μ V/m	---	dB μ V/m	dB	---
10104.8	56.9	Peak	74.0	17.1	H
10104.8	48.0	Average	54.0	6.0	H
12559.5	43.8	Peak	74.0	30.2	V
12559.5	36.5	Average	54.0	17.5	V
25379.2	49.8	Peak	74.0	24.2	H
25379.2	42.5	Average	54.0	11.6	V

Radiated Spurious – CH6F

Frequency	Level	Detector	Limit	Margin	Polar
MHz	dB μ V/m	---	dB μ V/m	dB	---
10094.0	56.3	Peak	74.0	17.7	V
10094.0	48.0	Average	54.0	6.0	V
25386.2	51.5	Peak	74.0	22.5	H
25386.2	42.8	Average	54.0	11.2	H

Radiated Spurious – CH9F

Frequency	Level	Detector	Limit	Margin	Polar
MHz	dB μ V/m	---	dB μ V/m	dB	---
10101.6	47.9	Average	54.0	6.1	V
10102.1	58.0	Peak	74.0	16.1	V
25891.2	49.5	Peak	74.0	24.5	V
25891.2	42.6	Average	54.0	11.4	V

1 GHz – 26.5 GHz, 802.11n40, MCS0, Chain B

Radiated Spurious – CH3F

Frequency	Level	Detector	Limit	Margin	Polar
MHz	dB μ V/m	---	dB μ V/m	dB	---
10249.8	47.7	Average	54.0	6.3	H
10250.3	58.1	Peak	74.0	15.9	H
12468.5	44.4	Peak	74.0	29.6	V
12468.5	36.4	Average	54.0	17.6	H
25413.5	49.4	Peak	74.0	24.6	V
25413.5	42.6	Average	54.0	11.4	H

Radiated Spurious – CH6F

Frequency	Level	Detector	Limit	Margin	Polar
MHz	dB μ V/m	---	dB μ V/m	dB	---
10006.0	56.8	Peak	74.0	17.2	H
10006.0	48.2	Average	54.0	5.8	H
25904.2	49.5	Peak	74.0	24.5	V
25904.2	42.3	Average	54.0	11.7	H

Radiated Spurious – CH9F

Frequency	Level	Detector	Limit	Margin	Polar
MHz	dB μ V/m	---	dB μ V/m	dB	---
10196.0	58.0	Peak	74.0	16.0	H
10196.6	48.1	Average	54.0	5.9	V
25387.0	50.3	Peak	74.0	23.7	V
25387.0	42.4	Average	54.0	11.6	H

1 GHz – 26.5 GHz, 802.11n40, MCS0, Chain A+B

Radiated Spurious – CH3F

Frequency	Level	Detector	Limit	Margin	Polar
MHz	dB μ V/m	---	dB μ V/m	dB	---
10200.9	47.9	Average	54.0	6.2	H
10201.5	56.8	Peak	74.0	17.2	H
12517.5	44.0	Peak	74.0	30.0	V
12517.5	35.9	Average	54.0	18.1	V
25406.2	49.7	Peak	74.0	24.3	H
25406.2	42.1	Average	54.0	11.9	H

Radiated Spurious – CH6F

Frequency	Level	Detector	Limit	Margin	Polar
MHz	dB μ V/m	---	dB μ V/m	dB	---
10148.3	57.8	Peak	74.0	16.2	V
10148.3	48.2	Average	54.0	5.8	H
25401.2	51.7	Peak	74.0	22.3	V
25401.2	42.2	Average	54.0	11.8	H

Radiated Spurious – CH9F

Frequency	Level	Detector	Limit	Margin	Polar
MHz	dB μ V/m	---	dB μ V/m	dB	---
10196.6	57.0	Peak	74.0	17.0	H
10196.6	48.3	Average	54.0	5.7	H
25907.0	49.7	Peak	74.0	24.3	H
25907.0	42.3	Average	54.0	11.7	V

1 GHz – 26.5 GHz, 802.11ax/be40, MCS0, Chain A

Radiated Spurious – CH3F

Frequency	Level	Detector	Limit	Margin	Polar
MHz	dB μ V/m	---	dB μ V/m	dB	---
10040.8	56.7	Peak	74.0	17.3	H
10040.8	47.8	Average	54.0	6.2	H
12060.5	48.1	Peak	74.0	25.9	H
12061.5	40.5	Average	54.0	13.5	H

Radiated Spurious – CH6F

Frequency	Level	Detector	Limit	Margin	Polar
MHz	dB μ V/m	---	dB μ V/m	dB	---
10001.1	57.3	Peak	74.0	16.7	H
10001.1	47.6	Average	54.0	6.4	V
24949.2	48.9	Peak	74.0	25.1	V
24949.2	42.2	Average	54.0	11.8	H

Radiated Spurious – CH9F

Frequency	Level	Detector	Limit	Margin	Polar
MHz	dB μ V/m	---	dB μ V/m	dB	---
10023.4	55.9	Peak	74.0	18.1	V
10023.4	48.0	Average	54.0	6.0	V
24920.8	49.8	Peak	74.0	24.2	H
24920.8	42.1	Average	54.0	11.9	V

1 GHz – 26.5 GHz, 802.11ax/be40, MCS0, Chain B

Radiated Spurious – CH3F

Frequency	Level	Detector	Limit	Margin	Polar
MHz	dB μ V/m	---	dB μ V/m	dB	---
10003.9	57.7	Peak	74.0	16.3	H
10003.9	47.7	Average	54.0	6.3	H
12061.8	47.3	Peak	74.0	26.7	H
12061.8	41.5	Average	54.0	12.5	V
24122.8	51.9	Peak	74.0	22.1	V
24122.8	43.3	Average	54.0	10.7	V

Radiated Spurious – CH6F

Frequency	Level	Detector	Limit	Margin	Polar
MHz	dB μ V/m	---	dB μ V/m	dB	---
10022.3	56.9	Peak	74.0	17.1	V
10022.9	47.7	Average	54.0	6.3	H
12137.0	45.7	Peak	74.0	28.3	H
12137.0	38.4	Average	54.0	15.6	V
16991.2	48.8	Peak	74.0	25.2	V
16991.5	40.8	Average	54.0	13.2	V
24273.2	50.3	Peak	74.0	23.7	H
24273.2	42.7	Average	54.0	11.3	V

Radiated Spurious – CH9F

Frequency	Level	Detector	Limit	Margin	Polar
MHz	dB μ V/m	---	dB μ V/m	dB	---
10039.1	56.2	Peak	74.0	17.8	H
10039.1	48.0	Average	54.0	6.0	V
12211.2	45.2	Peak	74.0	28.8	V
12211.2	39.0	Average	54.0	15.0	V
24423.8	50.4	Peak	74.0	23.6	V
24423.8	42.8	Average	54.0	11.2	V

1 GHz – 26.5 GHz, 802.11ax/be40, MCS0, Chain A+B

Radiated Spurious – CH3F

Frequency	Level	Detector	Limit	Margin	Polar
MHz	dB μ V/m	---	dB μ V/m	dB	---
10019.6	47.8	Average	54.0	6.2	H
10020.1	57.6	Peak	74.0	16.4	H
12060.2	50.3	Peak	74.0	23.7	H
12062.5	40.6	Average	54.0	13.4	H
16884.8	40.2	Average	54.0	13.8	V
16889.5	49.3	Peak	74.0	24.7	V
24123.8	52.2	Peak	74.0	21.8	V
24124.0	42.1	Average	54.0	11.9	V

Radiated Spurious – CH6F

Frequency	Level	Detector	Limit	Margin	Polar
MHz	dB μ V/m	---	dB μ V/m	dB	---
10108.1	57.1	Peak	74.0	16.9	H
10108.1	47.9	Average	54.0	6.1	H
12135.8	46.9	Peak	74.0	27.1	H
12136.5	38.2	Average	54.0	15.8	H
24273.8	51.2	Peak	74.0	22.8	V
24273.8	43.9	Average	54.0	10.2	V

Radiated Spurious – CH9F

Frequency	Level	Detector	Limit	Margin	Polar
MHz	dB μ V/m	---	dB μ V/m	dB	---
10136.3	57.0	Peak	74.0	17.0	V
10136.3	47.9	Average	54.0	6.1	V
12212.0	46.5	Peak	74.0	27.5	V
12212.2	38.2	Average	54.0	15.8	V
24425.0	53.4	Peak	74.0	20.6	V
24425.0	40.8	Average	54.0	13.2	V

B.2.6 Out of band emissions - band-edge (conducted)

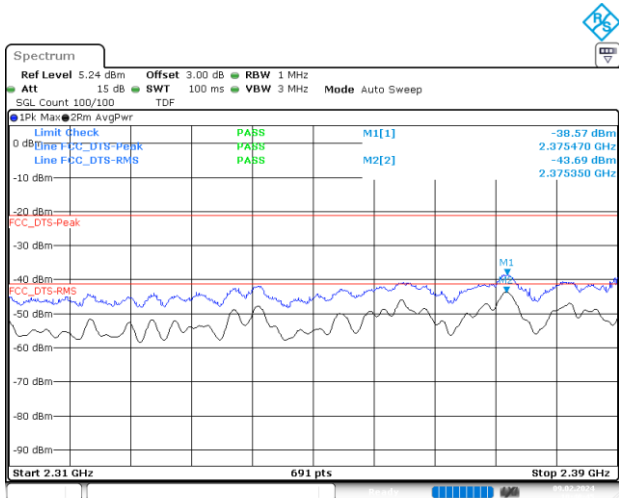

BE-R-LOW, SISO-A, 802.11b-1Mbps, Ch1

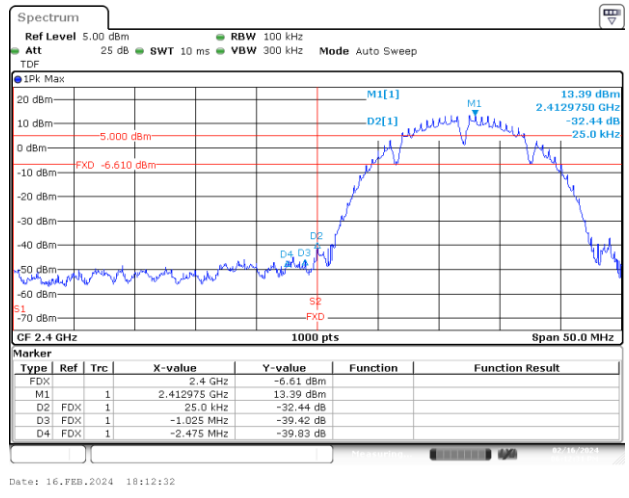

BE-NR, SISO-A, 802.11b-1Mbps, Ch1



BE-R-HIGH, SISO-A, 802.11b-1Mbps, Ch11

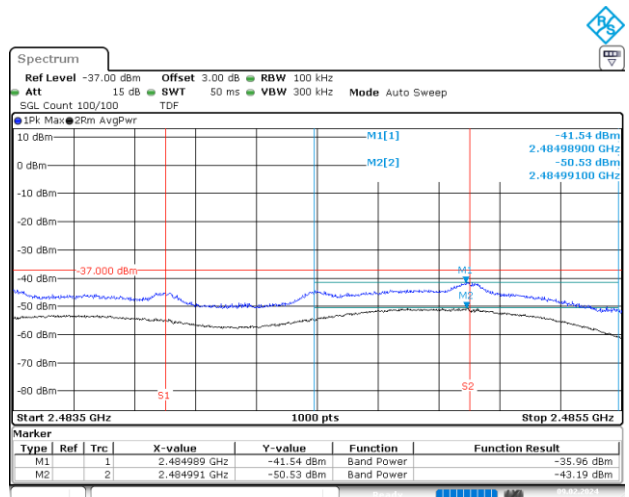

BE-R-HIGH-2MHz, SISO-A, 802.11b-1Mbps, Ch11



BE-R-HIGH, SISO-A, 802.11b-1Mbps, Ch12

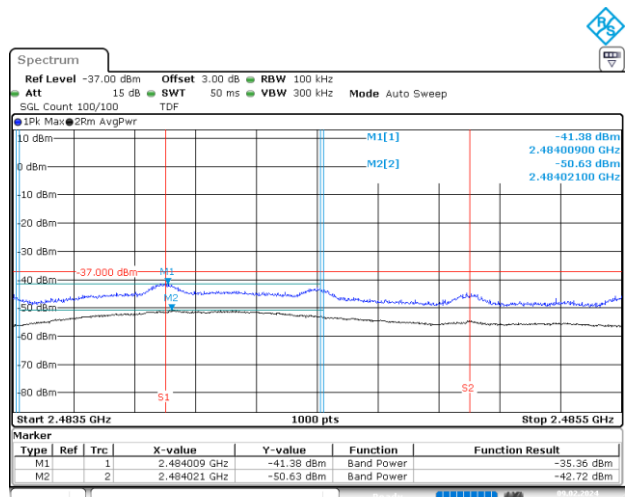

BE-R-HIGH-2MHz, SISO-A, 802.11b-1Mbps, Ch12



Date: 9.FEB.2024 10:46:01

BE-R-HIGH, SISO-A, 802.11b-1Mbps, Ch13

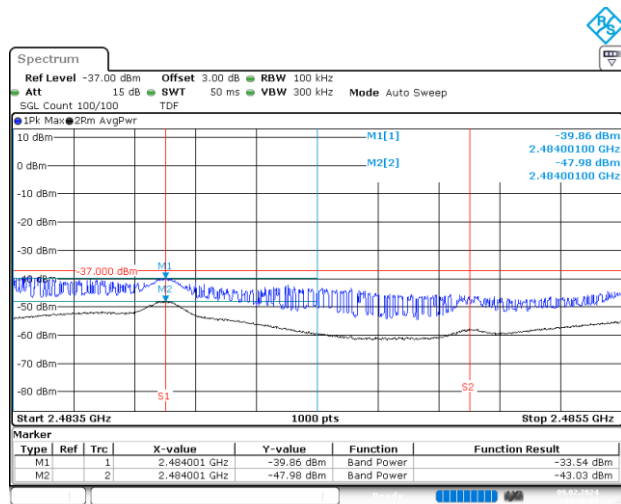

Date: 9.FEB.2024 10:46:09

BE-R-HIGH-2MHz, SISO-A, 802.11b-1Mbps, Ch13

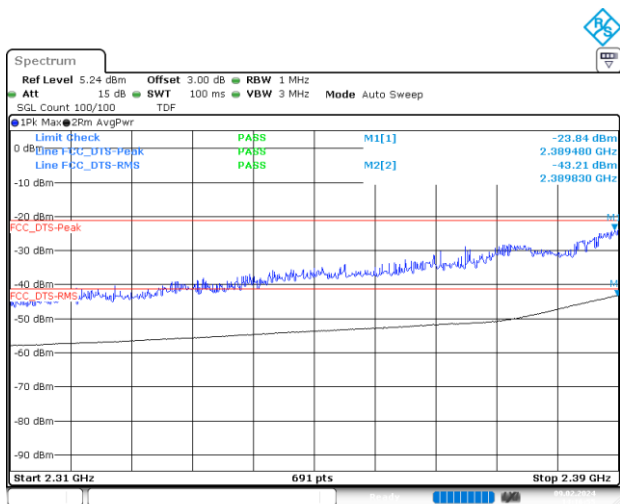

Date: 9.FEB.2024 14:16:55

BE-R-LOW, SISO-A, 802.11g-6Mbps, Ch1

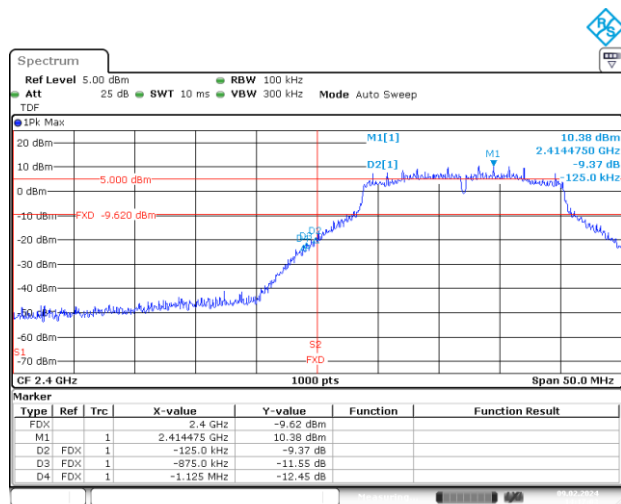

Date: 9.FEB.2024 14:17:03

BE-NR, SISO-A, 802.11g-6Mbps, Ch1

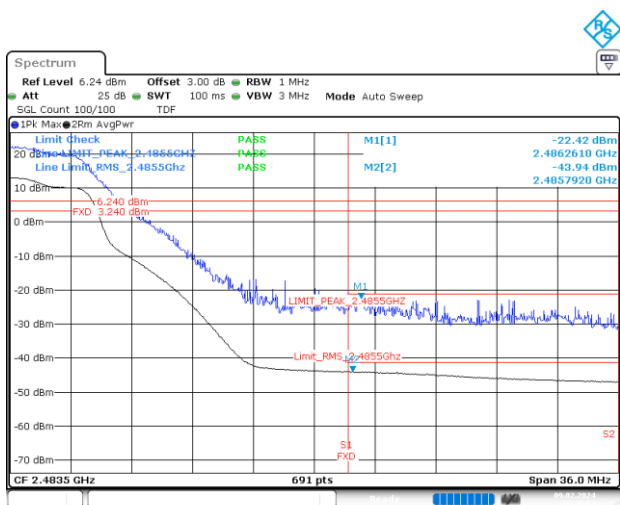

Date: 9.FEB.2024 10:49:54

BE-R-HIGH, SISO-A, 802.11g-6Mbps, Ch11

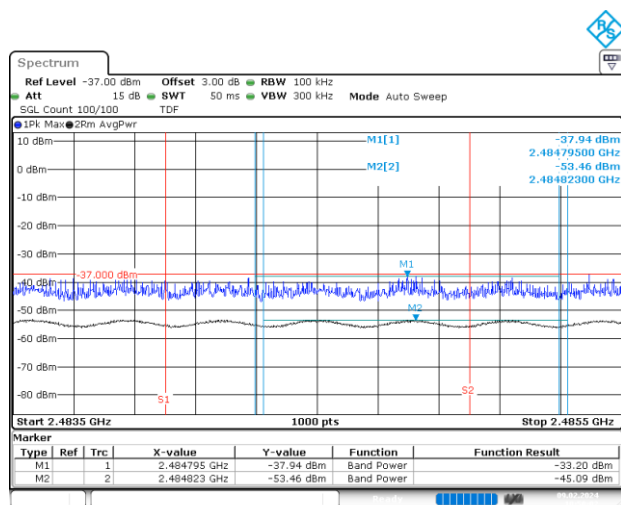

Date: 9.FEB.2024 10:50:02

BE-R-HIGH-2MHz, SISO-A, 802.11g-6Mbps, Ch11

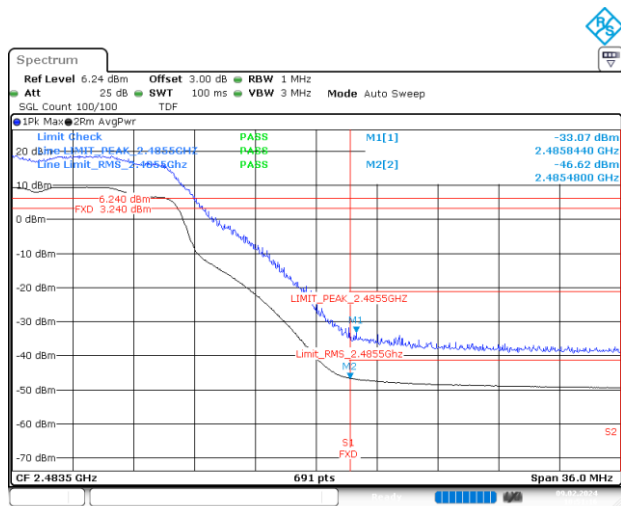

Date: 9.FEB.2024 10:51:16

BE-R-HIGH, SISO-A, 802.11g-6Mbps, Ch12

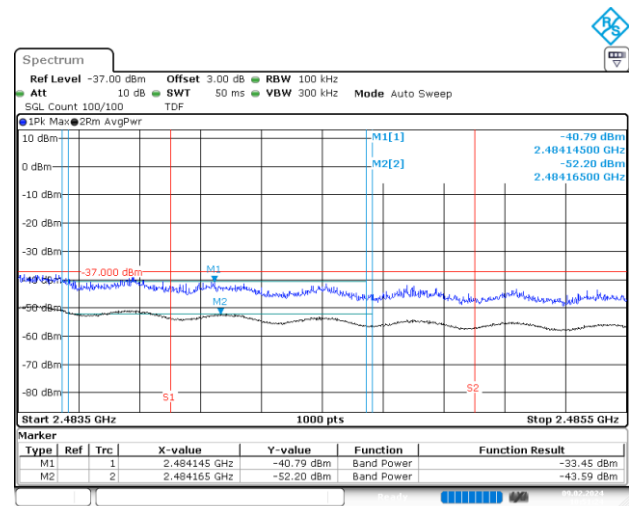

Date: 9.FEB.2024 10:51:24

BE-R-HIGH-2MHz, SISO-A, 802.11g-6Mbps, Ch12

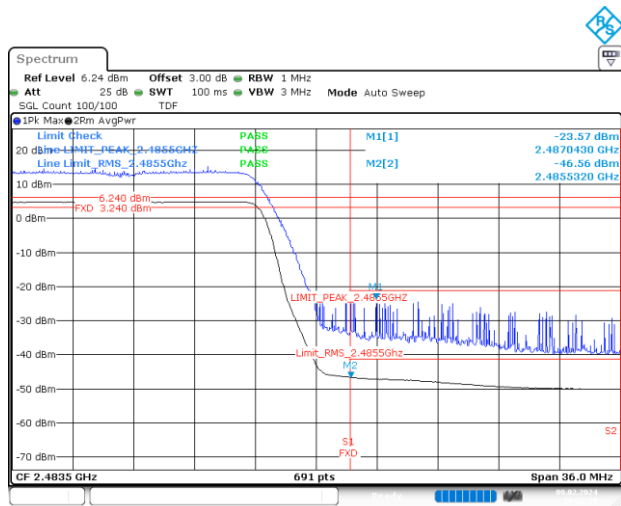

Date: 9.FEB.2024 10:52:38

BE-R-HIGH, SISO-A, 802.11g-6Mbps, Ch13

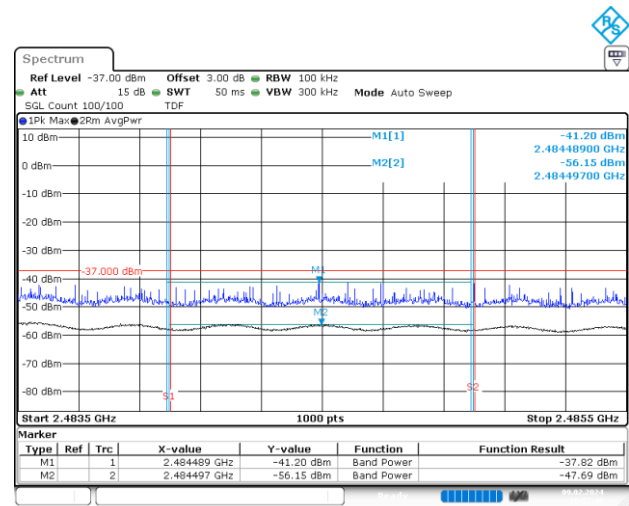

Date: 9.FEB.2024 10:52:46

BE-R-HIGH-2MHz, SISO-A, 802.11g-6Mbps, Ch13

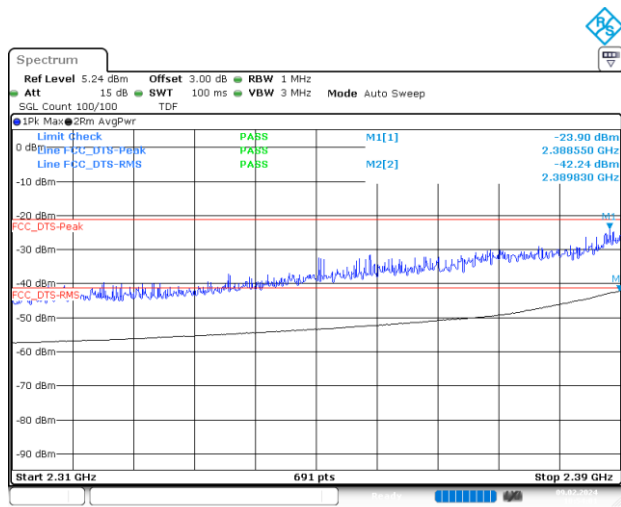

Date: 9.FEB.2024 10:54:01

BE-R-LOW, SISO-A, 802.11n20-HT0, Ch1

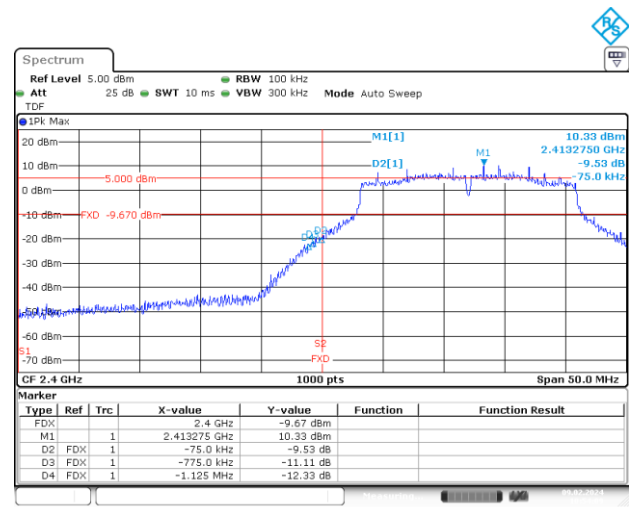

Date: 9.FEB.2024 10:54:09

BE-NR, SISO-A, 802.11n20-HT0, Ch1

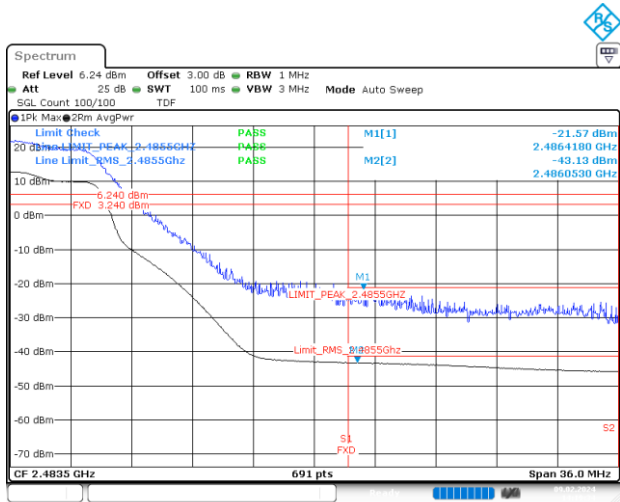

Date: 9.FEB.2024 14:19:34

BE-R-HIGH, SISO-A, 802.11n20-HT0, Ch11

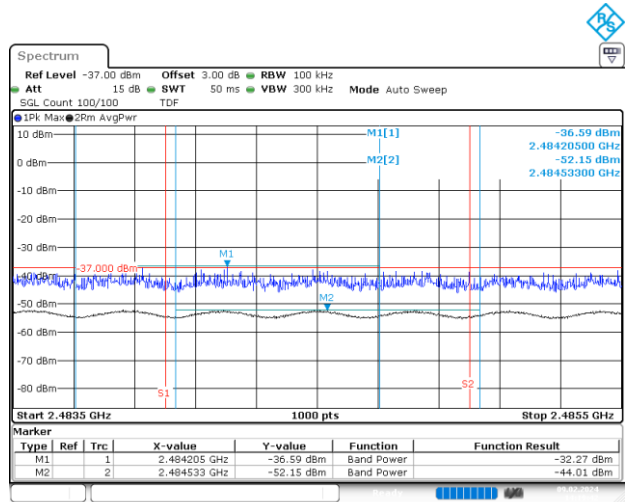

Date: 9.FEB.2024 14:19:42

BE-R-HIGH-2MHz, SISO-A, 802.11n20-HT0, Ch11

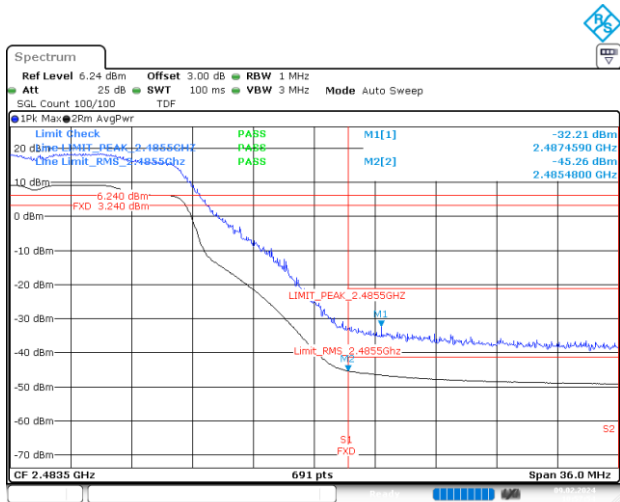

Date: 9.FEB.2024 10:57:54

BE-R-HIGH, SISO-A, 802.11n20-HT0, Ch12

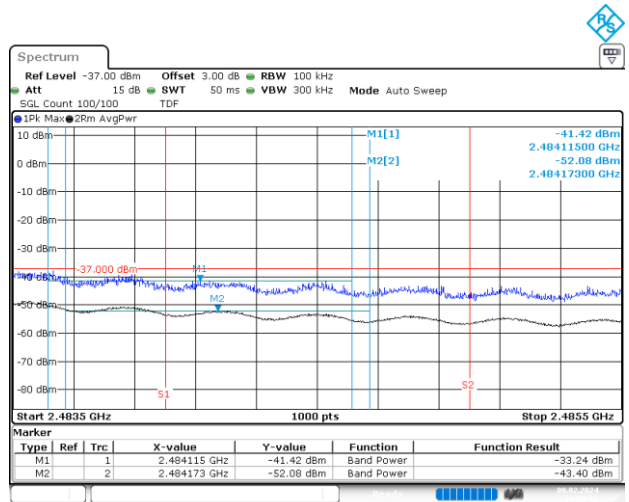

Date: 9.FEB.2024 10:58:02

BE-R-HIGH-2MHz, SISO-A, 802.11n20-HT0, Ch12

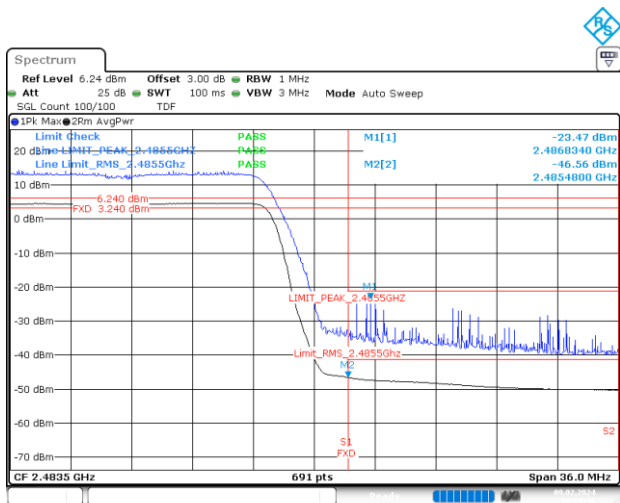

Date: 9.FEB.2024 10:59:16

BE-R-HIGH, SISO-A, 802.11n20-HT0, Ch13

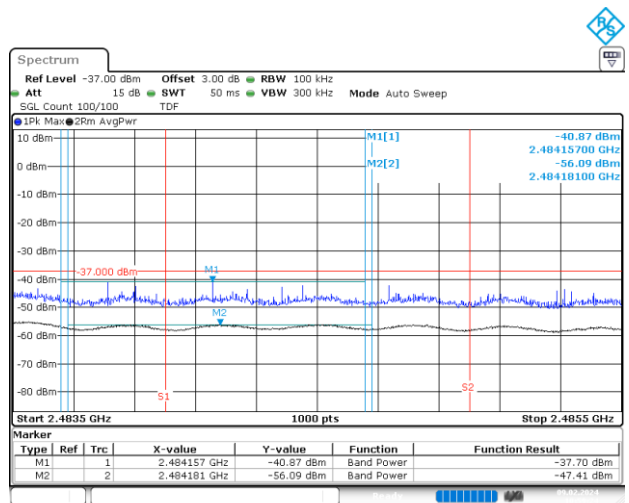

Date: 9.FEB.2024 10:59:24

BE-R-HIGH-2MHz, SISO-A, 802.11n20-HT0, Ch13

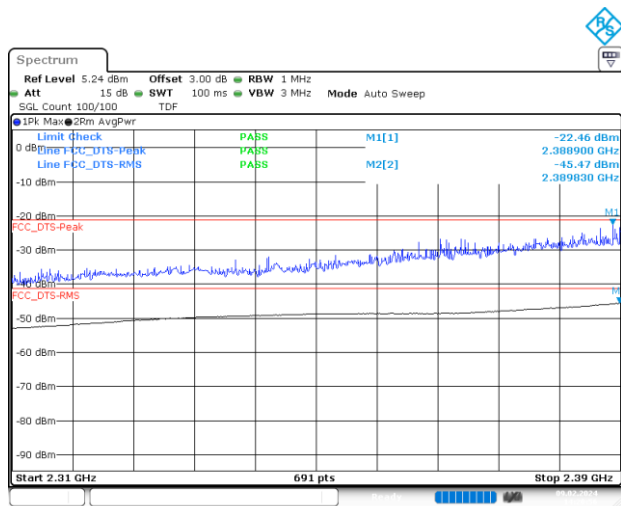

Date: 9.FEB.2024 14:20:56

BE-R-LOW, SISO-A, 802.11n40-HT0, Ch3

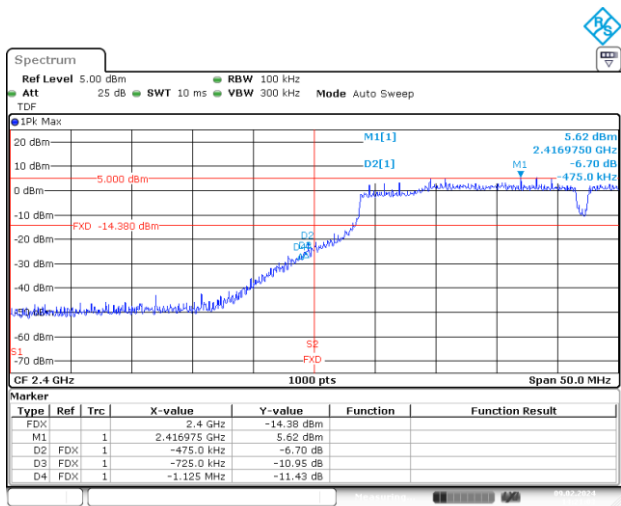

Date: 9.FEB.2024 14:21:04

BE-NR, SISO-A, 802.11n40-HT0, Ch3

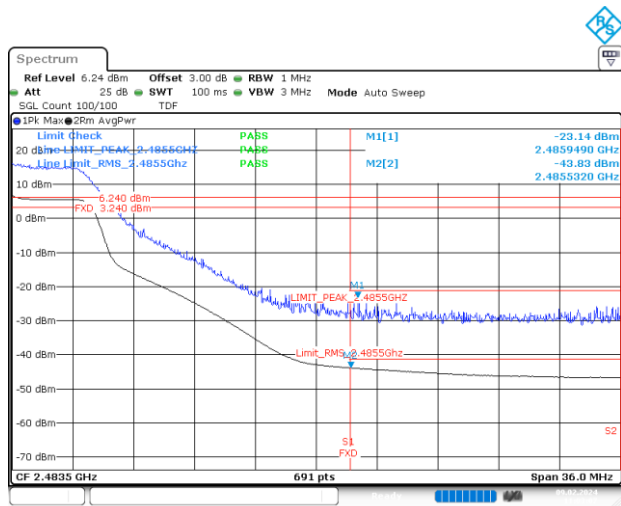

Date: 9.FEB.2024 11:03:07

BE-R-HIGH, SISO-A, 802.11n40-HT0, Ch9

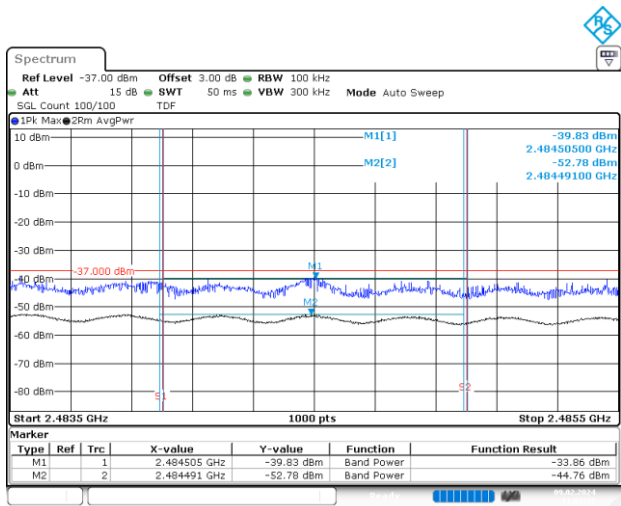

Date: 9.FEB.2024 11:03:15

BE-R-HIGH-2MHz, SISO-A, 802.11n40-HT0, Ch9

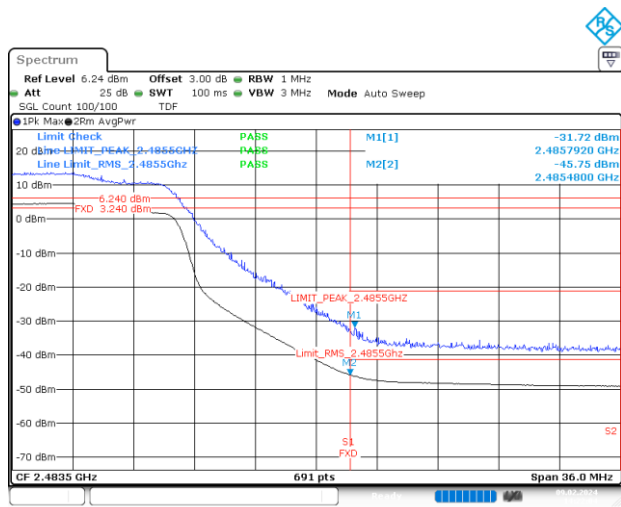

Date: 9.FEB.2024 14:22:04

BE-R-HIGH, SISO-A, 802.11n40-HT0, Ch10

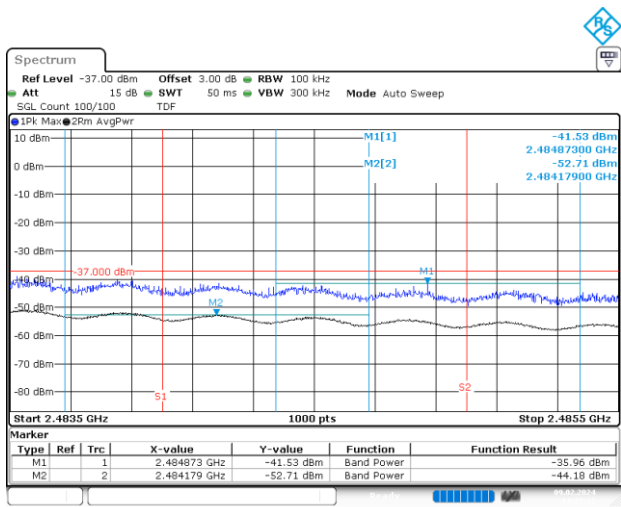

Date: 9.FEB.2024 14:22:12

BE-R-HIGH-2MHz, SISO-A, 802.11n40-HT0, Ch10

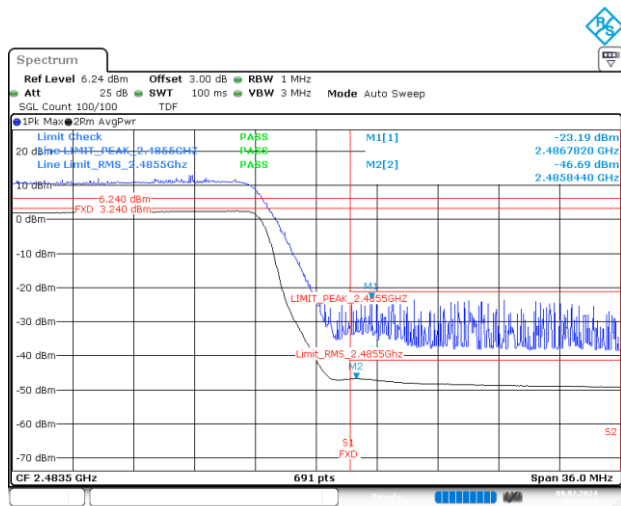

Date: 9.FEB.2024 14:23:25

BE-R-HIGH, SISO-A, 802.11n40-HT0, Ch11

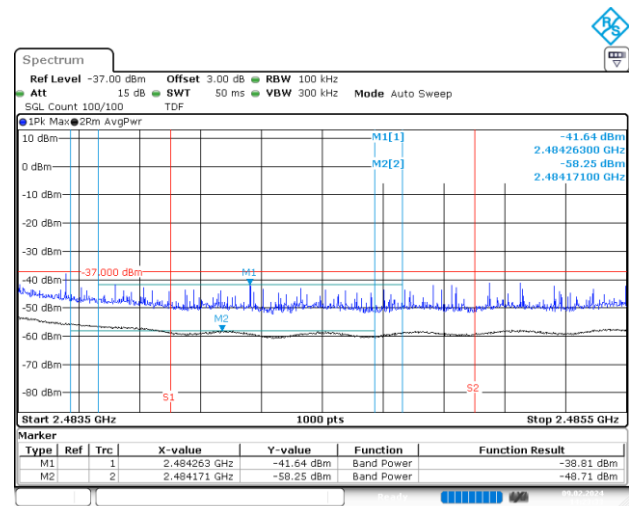

Date: 9.FEB.2024 14:23:33

BE-R-HIGH-2MHz, SISO-A, 802.11n40-HT0, Ch11

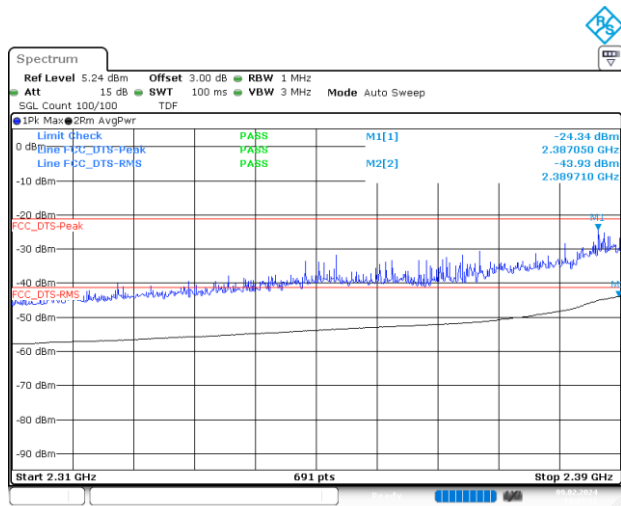

Date: 9.FEB.2024 11:07:12

BE-R-LOW, SISO-A, 802.11ax20-HE0, Ch11

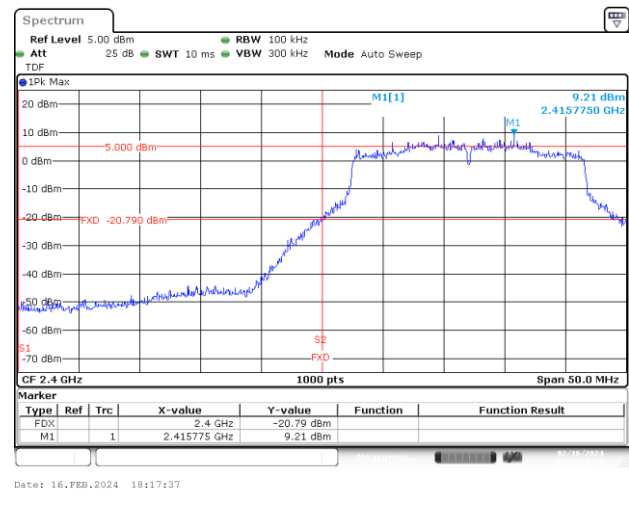

Date: 16.FEB.2024 18:17:37

BE-NR, SISO-A, 802.11ax20-HE0, Ch11

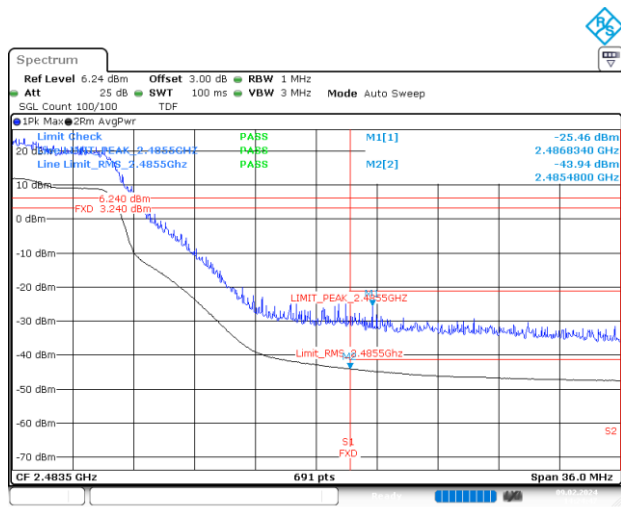

Date: 9.FEB.2024 14:24:48

BE-R-HIGH, SISO-A, 802.11ax20-HE0, Ch11

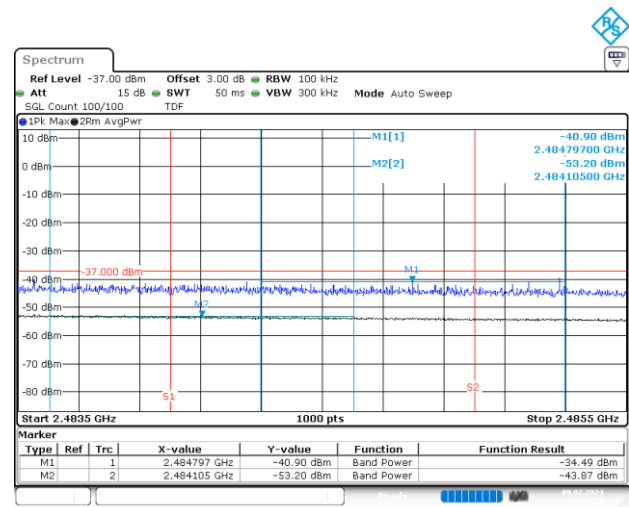

Date: 9.FEB.2024 14:24:56

BE-R-HIGH-2MHz, SISO-A, 802.11ax20-HE0, Ch11

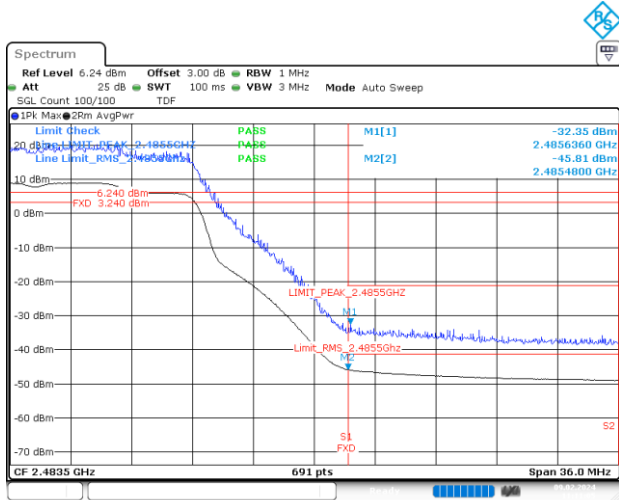

Date: 9.FEB.2024 11:11:06

BE-R-HIGH, SISO-A, 802.11ax20-HE0, Ch12

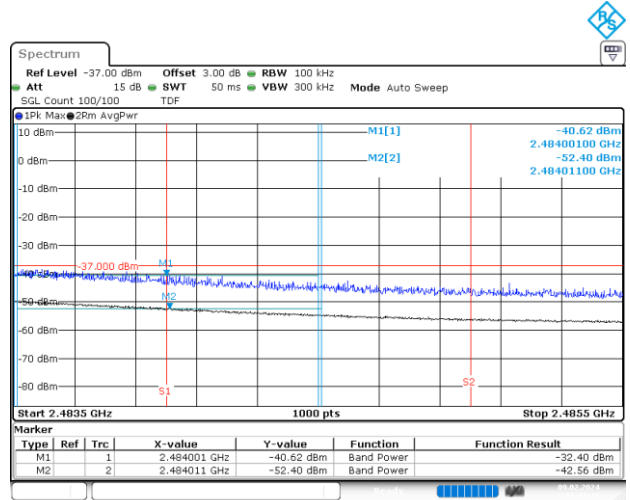

Date: 9.FEB.2024 11:11:14

BE-R-HIGH-2MHz, SISO-A, 802.11ax20-HE0, Ch12



Date: 9.FEB.2024 14:26:29

BE-R-HIGH, SISO-A, 802.11ax20-HE0, Ch13

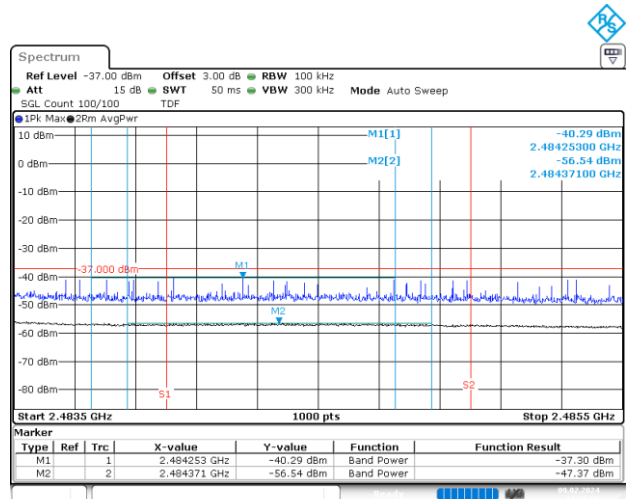

Date: 9.FEB.2024 14:26:37

-BE-R-HIGH-2MHz, SISO-A, 802.11ax20-HE0, Ch13

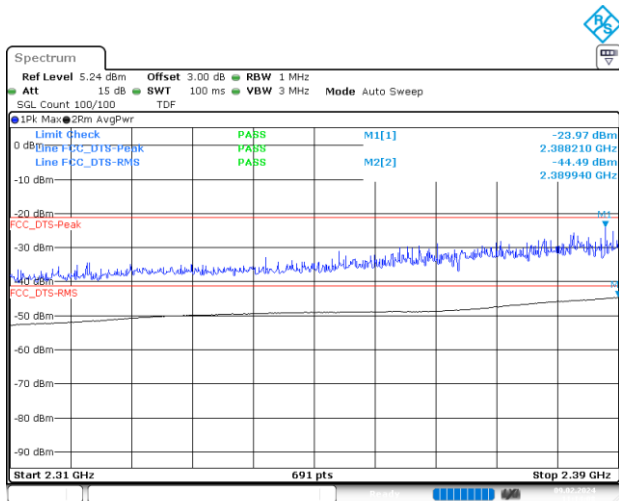

Date: 9.FEB.2024 11:14:08

BE-R-LOW, SISO-A, 802.11ax40-HE0, Ch3

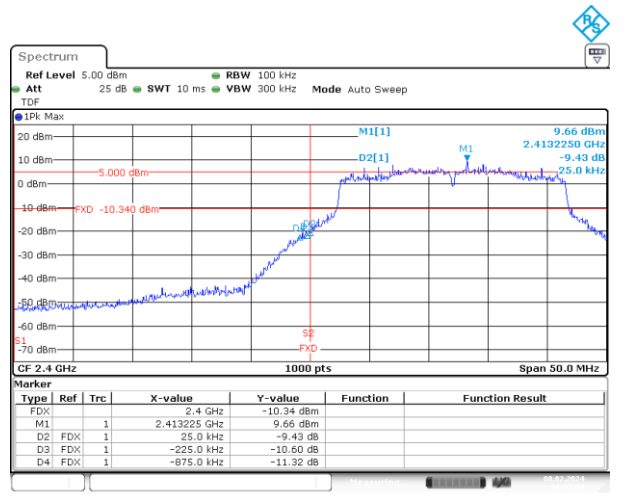

Date: 8.FEB.2024 16:31:14

BE-NR, SISO-A, 802.11ax40-HE0, Ch3

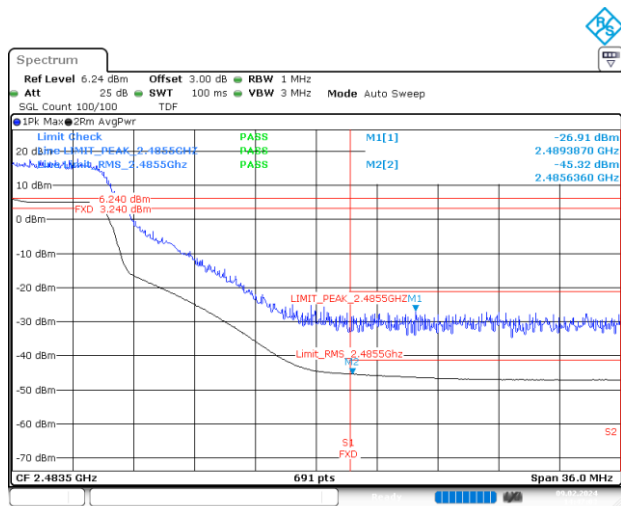

Date: 9.FEB.2024 14:47:04

BE-R-HIGH, SISO-A, 802.11ax40-HE0, Ch9

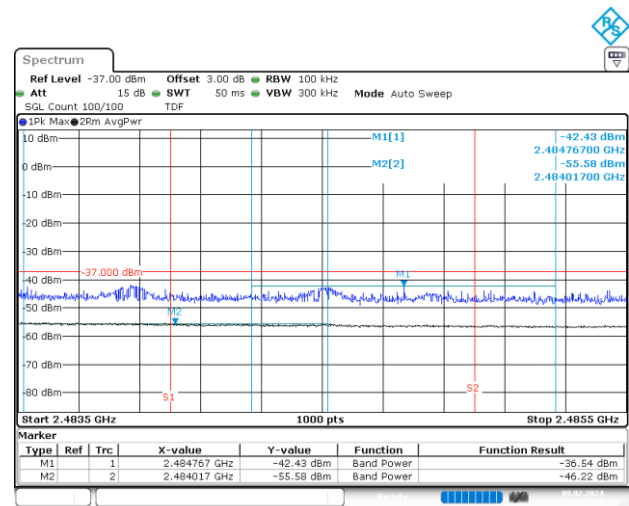

Date: 9.FEB.2024 14:47:12

BE-R-HIGH-2MHz, SISO-A, 802.11ax40-HE0, Ch9

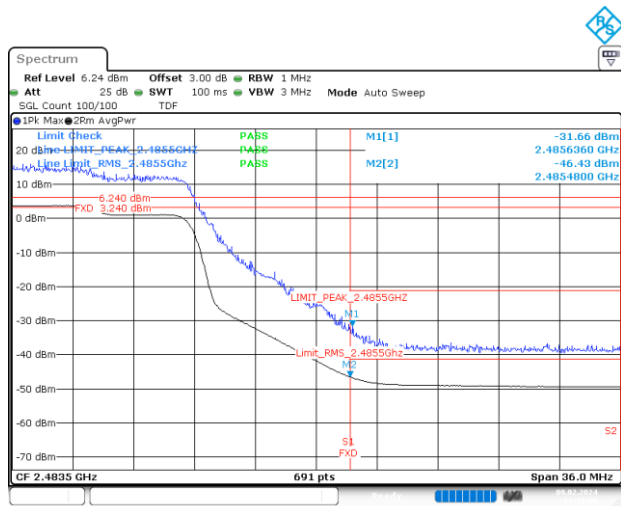

Date: 9.FEB.2024 11:18:00

BE-R-HIGH, SISO-A, 802.11ax40-HE0, Ch10

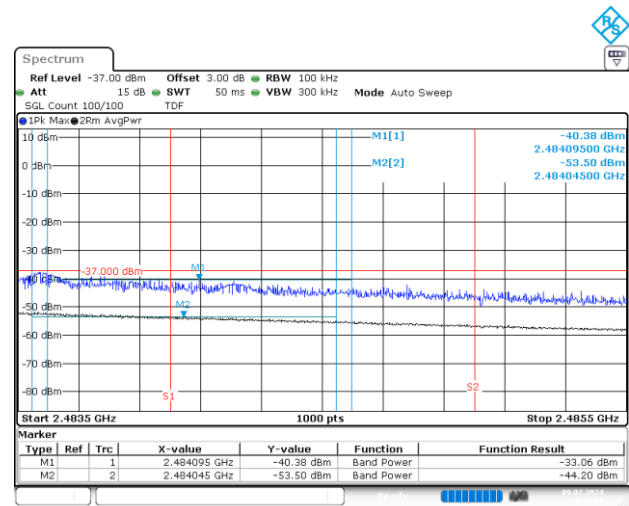

Date: 9.FEB.2024 11:18:08

BE-R-HIGH-2MHz, SISO-A, 802.11ax40-HE0, Ch10

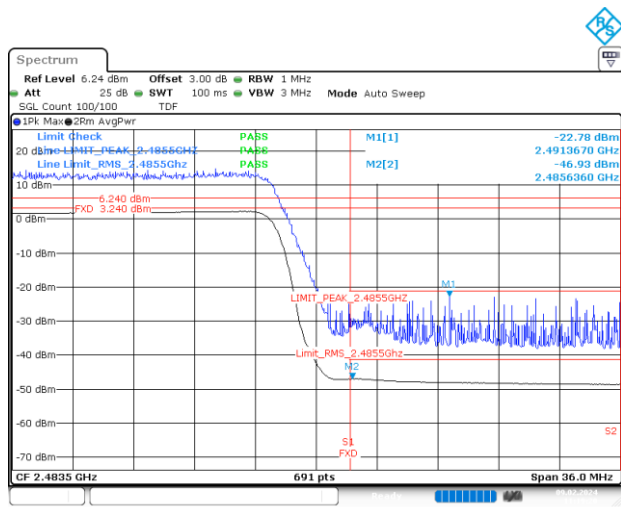

Date: 9.FEB.2024 11:19:21

BE-R-HIGH, SISO-A, 802.11ax40-HE0, Ch11

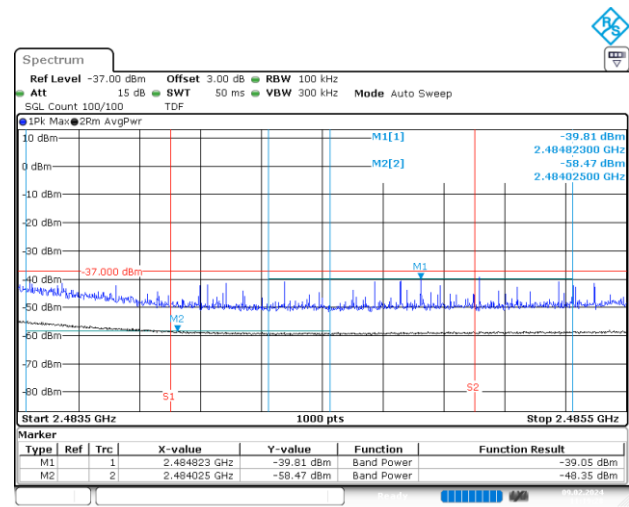

Date: 9.FEB.2024 11:19:29

BE-R-HIGH-2MHz, SISO-A, 802.11ax40-HE0, Ch11

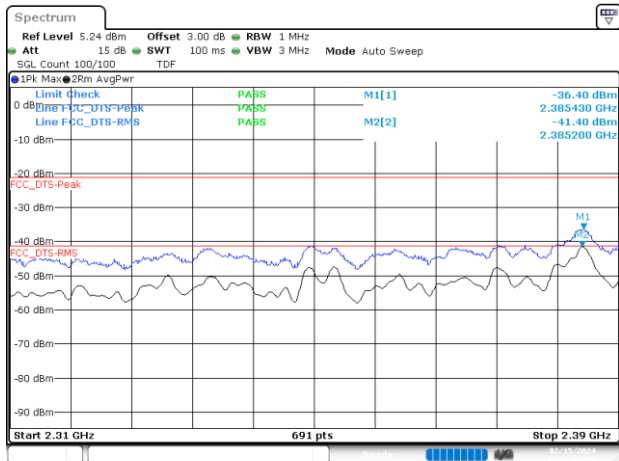

BE-R-LOW, SISO-B, 802.11b-1Mbps, Ch1

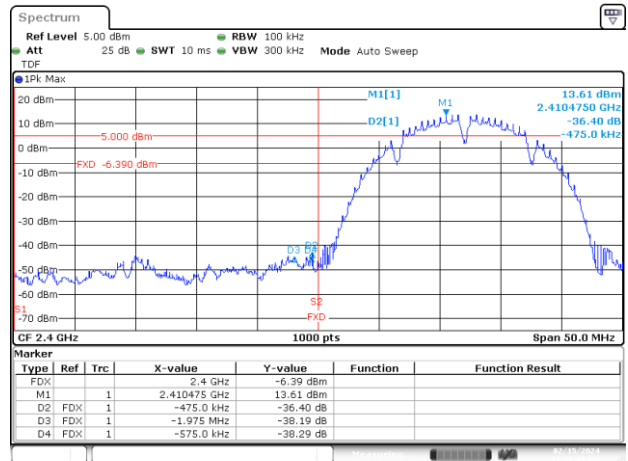

BE-NR, SISO-B, 802.11b-1Mbps, Ch1

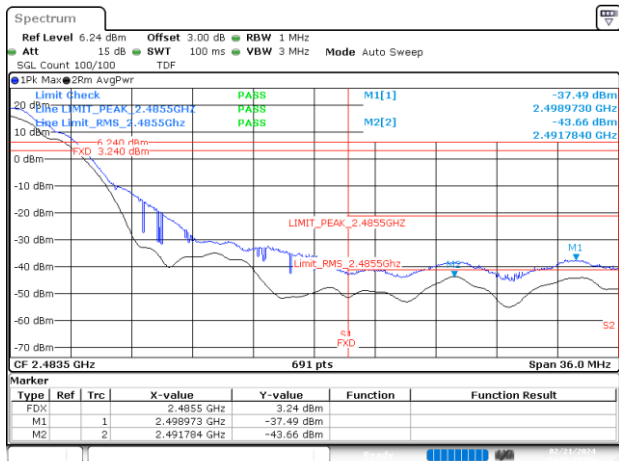

BE-R-HIGH, SISO-B, 802.11b-1Mbps, Ch11

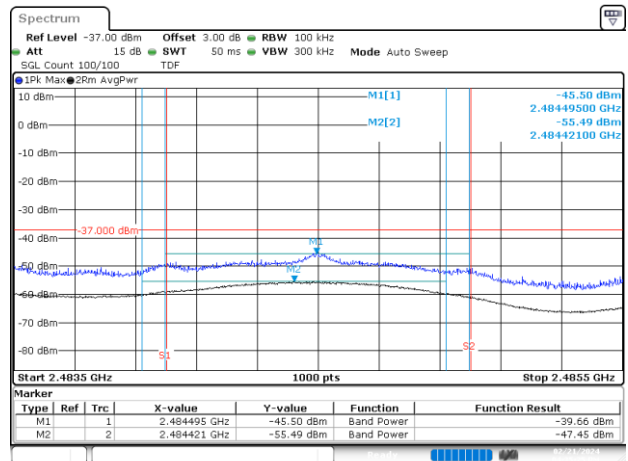

BE-R-HIGH-2MHz, SISO-B, 802.11b-1Mbps, Ch11

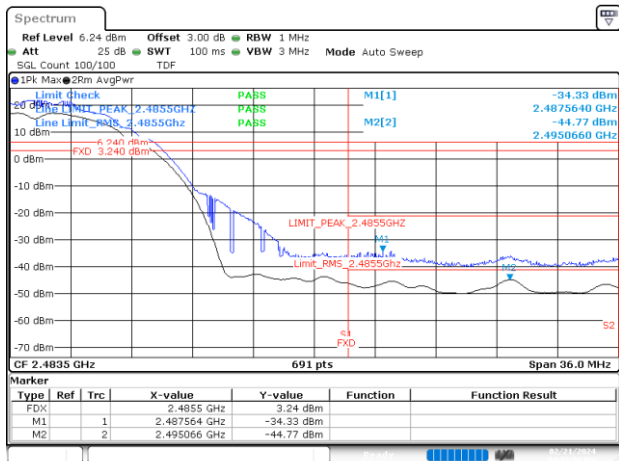

BE-R-HIGH, SISO-B, 802.11b-1Mbps, Ch12

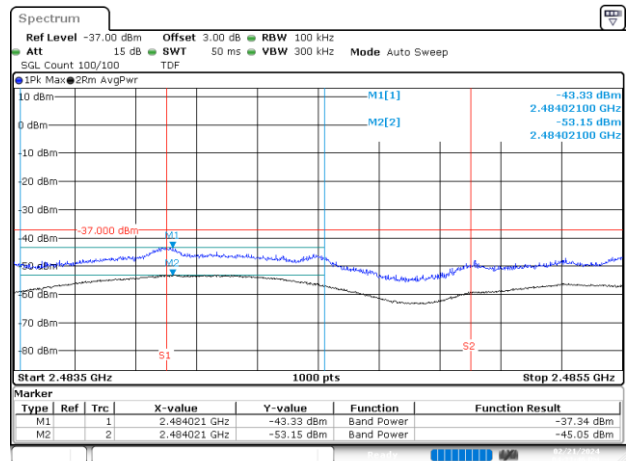

BE-R-HIGH-2MHz, SISO-B, 802.11b-1Mbps, Ch12