

YAESU

The radio

FTM-100DR

Operating Manual

**144/430MHz
DUAL BAND TRANSCEIVER**

C4FM FDMA

- Before Using**
- Installation and Connection**
- Basic Operations**
- Using the Memory**
- Scanning**
- Using the GPS Function**
- Using the APRS Function**
- Using the GM Function**
- Convenient Function**
- Functions to be used when
Necessary**
- Customize Menu Settings and
User Preferences**
- Appendix**

Introduction

Features of this radio

- 144/430 MHz dual band mobile radio equipped with standard C4FM digital communication modem
- Clear audio and data communication is achieved using the digital modem functions
- Wide band receive in the 108 MHz to 999 MHz range (wireless business, public service and air band)
- Transmission power

FTM-100DR	Standard model	Transmission power 10W	
-----------	----------------	------------------------	--

- The dot matrix LCD is mounted on the controller
 - 500 memory channels in the Band A (band at the top of the display) and 500 channels in the Band B (band at the bottom of the display)
 - The frequency and settings memories can be saved, using a micro-SD card. The data in the micro-SD card can easily be copied to other radios
 - Diverse range of scanning functions (VFO scan, memory scan etc.)
 - Built-in GPS receiver unit, location and movement information can be displayed and GPS data can be output to connected devices
 - Incorporated APRS® functions. Position, movement data and messages can be communicated to other stations, digipeaters and the Internet.
*Refer to the separate “APRS Operating Manual”
 - GM (Group Monitor) function where in a group of frequently communicating members can be registered, and then position information and messages can be exchanged
*Refer to the separate “GM Operating Manual”
 - Supports Yaesu WIRES-X Internet linking, providing communication with remote partners using the Internet
*Refer to the separate “WIRES-X Operating Manual”
 - Bluetooth adaptor unit BU-2 (sold separately) permits hands-free operation
 - Voice guide unit FVS-2 (sold separately) provides frequency voice announcement, and recording of received audio
- * The APRS, GM and WIRES-X Operating Manuals are not included with the product. Please download them from the Yaesu website.

Important precautions for mobile radio operation

- The use of protective tape or covering is recommended to protect the wiring and the power cord inside the vehicle.
- When installing the unit inside a vehicle, locate the radio, antenna, co-axial cable, etc. at least 20 cm away from the following control equipment.
 - **Engine-related:** Fuel injection equipment and engine control
 - **Transmission-related:** Transmission and 4WD electronic control unit
 - **Others:** ECS/EPS/ABS/ETACS/Fully automatic air-conditioner/
Auto-heater control unit/G sensor
- Install the antenna and co-axial cable away from the control unit and wiring harness. Place all cables so they do not entangle and impede the driver or passengers. Never place any equipment in a location where it may pose a danger to the passengers, where it may interfere with driving, or obstruct the driver field of view.
- Do not install any apparatus in such a way that it may interfere with the proper operation of the air bags.
- After installing the radio, check that the brake lamp, head lamp, turning indicator lights, wiper, etc. are working normally with the radio power switched on.
- Keep full attention on driving, do not operate the radio controls or look at the radio display while driving. Stop the vehicle at a safe location, before operating the radio controls or looking at the display.
- Do not drive the car in such a way that external sounds required for safe driving cannot be heard. Most areas and districts prohibit the use of earphones and headphones while driving.
- When using the radio transmitter, if it appears to have abnormal effects on the control equipment of the vehicle, stop the engine, turn off the power supply, and disconnect the power cord. Resolve the problem before continuing to operate the radio equipment.
- When using the radio in an electric or hybrid car, the receiver may experience high RF interference and noise from the inverters that are built into the electric vehicle.

Introduction

How to read this manual

In this manual, controller operations are expressed as follows:

PressIndicates that the key or switch is to be pressed quickly.

Press for 1 second or longerIndicates that the key or switch is to be pressed for one second or longer.

Select **[MODE]**Indicates that the items are to be highlighted on the touch panel screen.

The following symbols are also used in this manual:

Caution ...Explains information to avoid incorrect operation.

Tip ...Explains operating hints and helpful advice.

Also note: the actual product may differ from the drawings shown in this manual.

Safety Precautions (make sure to read these)

Make sure to read this manual in order to use this radio safely and correctly.

Note beforehand that the company shall not be liable for any damages suffered by the customer or third parties in using this product, or for any failures and faults that occur during the use or misuse of this product, unless otherwise provided for under the law.

Type and meaning of the marks



This symbol indicates the possibility of death or serious injury being inflicted on the user and the surrounding people when these instructions are ignored and the product is handled wrongly.



This symbol indicates the possibility of death or serious injury being inflicted on the user and the surrounding people when these instructions are ignored and the product is handled wrongly.



This symbol indicates the possibility of physical impediments occurring or impediments being inflicted on the user and the surrounding people when these instructions are ignored and the product is handled wrongly.

Type and meaning of symbols



Prohibited actions that must not be carried out in order to use this radio safely.

For example,  signifies that disassembly is prohibited.



Precautions that must be adhered to in order to use this radio safely. For example,  signifies that the power supply is to be disconnected.

||||| **DANGER** |||||



Do not use the device in “regions or aircrafts and vehicles where its use is prohibited” such as in hospitals and aeroplanes.

This may exert an impact on electronic and medical devices.



Do not use this product while driving or riding a motorbike. This may result in accidents.

Make sure to stop the car in a safe location first before use if the device is going to be used by the driver.



Never touch the antenna during transmission.



This may result in injury, electric shock and equipment failure.



When an alarm goes off with the external antenna connected, cut off the power supply to this radio immediately and disconnect the external antenna from this radio.







If not, this may result in fire, electric shock and equipment failure.





Safety Precautions (make sure to read these)

-  **Do not operate the device when flammable gas is generated.**
Doing so may result in fire and explosion.
-  **Do not transmit in crowded places in consideration of people who are fitted with medical devices such as heart pacemakers.**
Electromagnetic waves from the device may affect the medical device, resulting in accidents caused by malfunctions.

-  **Do not touch any liquid leaking from the liquid display with your bare hands.**
There is a risk of chemical burns occurring when the liquid comes into contact with the skin or gets into the eyes. In this case, seek medical treatment immediately.

WARNING

-  **Do not use voltages other than the specified power supply voltage.**
Doing so may result in fire and electric shock.
-  **Do not transmit continuously for long periods of time.**
This may cause the temperature of the main body to rise and result in burns and failures due to overheating.
-  **Do not dismantle or modify the device.**
This may result in injury, electric shock and equipment failure.
-  **Do not handle the power plug and connector etc. with wet hands. Also do not plug and unplug the power plug with wet hands.**
This may result in injury, liquid leak, electric shock and equipment failure.
-  **When smoke or strange odors are emitted from the radio, turn off the power and disconnect the power cord from the socket.**
This may result in fire, liquid leak, overheating, damage, ignition and equipment failure. Please contact our company amateur customer support or the retail store where you purchased the device.
-  **Keep the power plug pins and the surrounding areas clean at all times.**
This may result in fire, liquid leak, overheating, breakage, ignition etc.

-  **Do not place the device in areas that may get wet easily (e.g. near a humidifier).**
This may result in fire, electric shock and equipment failure.
-  **When connecting a DC power cord, pay due care not to mix up the positive and negative polarities.**
This may result in fire, electric shock and equipment failure.
-  **Do not use DC power cords other than the one enclosed or specified.**
This may result in fire, electric shock and equipment failure.
-  **Do not bend, twist, pull, heat and modify the power cord and connection cables in an unreasonable manner.**
This may cut or damage the cables and result in fire, electric shock and equipment failure.
-  **Do not pull the cable when plugging and unplugging the power cord and connection cables.**
Please hold the plug or connector when unplugging. If not, this may result in fire, electric shock and equipment failure.

Safety Precautions (make sure to read these)

 **Do not use the device when the power cord and connection cables are damaged, and when the DC power connector cannot be plugged in tightly.**

Please contact our company amateur customer support or the retail store where you purchased the device as this may result in fire, electric shock and equipment failure.

 **Never cut off the fuse holder of the DC power cord.**

This may cause short-circuiting and result in ignition and fire.

 **Do not use fuses other than those specified.**

Doing so may result in fire and equipment failure.

 **Do not allow metallic objects such as wires and water to get inside the product.**

This may result in fire, electric shock and equipment failure.

 **Refrain from using headphones and earphones at a loud volume.**

Continuous exposure to loud volumes may result in hearing impairment.

 **Disconnect the power cord and connection cables before incorporating items sold separately and replacing the fuse.**

This may result in fire, electric shock and equipment failure.

 **Follow the instructions given when installing items sold separately and replacing the fuse.**

This may result in fire, electric shock and equipment failure.

 **Do not use the device when the alarm goes off.**

For safety reasons, please pull the power plug of the DC power equipment connected to the product out of the AC socket.

Never touch the antenna as well. This may result in fire, electric shock and equipment failure due to thunder.

Before Using



CAUTION

 **Do not place this device near a heating instrument or in a location exposed to direct sunlight.**

This may result in deformation and discoloration.

 **Do not place this device in a location where there is a lot of dust and humidity.**

Doing so may result in fire and equipment failure.

 **Stay as far away from the antenna as possible during transmission.**

Long-term exposure to electromagnetic radiation may have a negative effect on the human body.

 **Do not wipe the case using thinner and benzene etc.**

Please use a soft and dry piece of cloth to wipe away the stains on the case.

 **For safety reasons, switch off the power and pull out the DC power cord connected to the DC power connector when the device is not going to be used for a long period of time.**

If not, this may result in fire and overheating.

 **Do not throw or subject the device to strong impact forces.**

This may result in equipment failure.

 **Do not put this device near magnetic cards and video tapes.**

The data in the cash card and video tape etc. may be erased.

 **Do not turn on the volume too high when using a headphone or earphone.**

This may result in hearing impairment.

Safety Precautions (make sure to read these)



Keep out of the reach of small children.

If not, this may result in injuries to children.



Do not put heavy objects on top of the power cord and connection cables.

This may damage the power cord and connection cables, resulting in fire and electric shock.



Do not transmit near the television and radio.

This may result in electromagnetic interference.



Do not use optional products other than those specified by our company.

If not, this may result in equipment failure.



When using the device in a hybrid car or fuel-saving car, make sure to check with the car manufacturer before using.

The device may not be able to receive transmissions normally due to the influence of noises from the electrical devices (inverters etc.) fitted in the car.



Do not place the device on an unsteady or sloping surface, or in a location where there is a lot of vibration.

The device may fall over or drop, resulting in fire, injury and equipment failure.



Do not stand on top of the product, and do not place heavy objects on top or insert objects inside it.

If not, this may result in equipment failure.



Do not use a microphone other than those specified when connecting a microphone to the device.

If not, this may result in equipment failure.



Do not touch the heat radiating parts.

When used for a long period of time, the temperature of the heat radiating parts will get higher, resulting in burns when touched.



Do not open the case of the product except when replacing the fuse and when installing items sold separately.





This may result in injury, electric shock and equipment failure.

Name and Function of Each Component

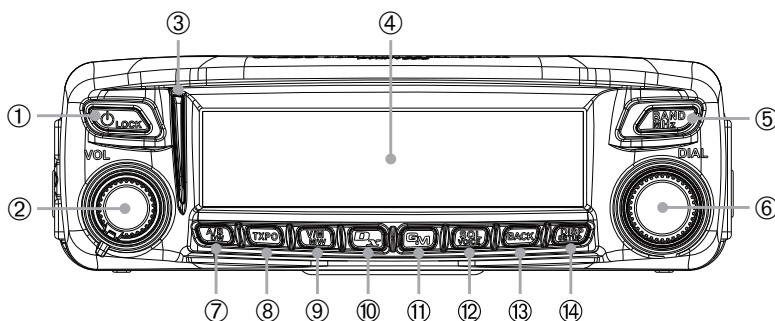





Controller

Front



- ① Power/Lock Switch ()
Pressing for over 2 seconds switches the power between ON and OFF.
Briefly pressing engages or releases the key lock while the radio is turned on.
- ② VOL knob
Turning clockwise increases the volume whereas turning counterclockwise decreases the volume.
- ③ Indicator
 - The top half lights green when in BUSY state.
 - The top half lights red during transmission.
 - The bottom half lights blue while receiving or transmitting digital voice signals.
 - The bottom half lights white while receiving or transmitting digital data.
- ④ Dot matrix LCD display
- ⑤ BAND MHz key ()
Switches the bands of the operating band.
Pressing and holding for over 1 second allows you to set the frequency in 5 MHz units.
- ⑥ DIAL knob
 - Allows you to set the operating band frequency.
Turning clockwise increases the frequency whereas turning counterclockwise decreases the frequency.
 - Allows you to select the desired item for setup, memory registration, group monitoring operation, etc.
- ⑦ A/B DW key ()
Briefly pressing each time switches the operating band between Band A and Band B.
Pressing for over 1 second each time switches the dual watch function between ON and OFF.
- ⑧ TXPO key ()
Briefly pressing each time switches the transmission power (HI/MID/LOW).

Name and Function of Each Component

- ⑨ V/M MW key ()
Briefly pressing each time switches between VFO mode and memory mode.
Pressing and holding for over 1 second displays the memory registration screen.
- ⑩ D/X key ()
Briefly pressing each time switches the communication mode of the operating band.
Pressing and holding for over 1 second activates WIRES-X.
- ⑪ GM key ()
Activates the GM (group monitor) function.
- ⑫ SQL VOICE key ()
Pressing this button briefly and rotating the DIAL sets the squelch level.
Pressing and holding for over 1 second activates VOICE mode.
- ⑬ BACK key ()
Briefly pressing enables the selected item or value. Then, the screen returns to the previous screen.
- ⑭ DISP SETUP key ()
Briefly pressing switches the display information (Partner station location information/your location information/GPS INFO).
Tip For details on the display information, see page xx.
Pressing and holding for over 1 second displays the set-up menu.

Back

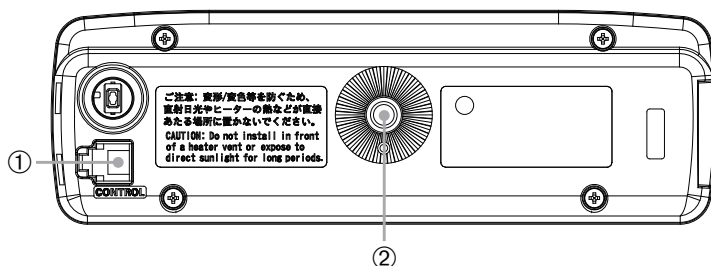

- ① CONTROL jack
Plug in the control cable into this jack to connect with the main body.
- ② Screw hole to attach the mounting bracket

Name and Function of Each Component

Main body

Front

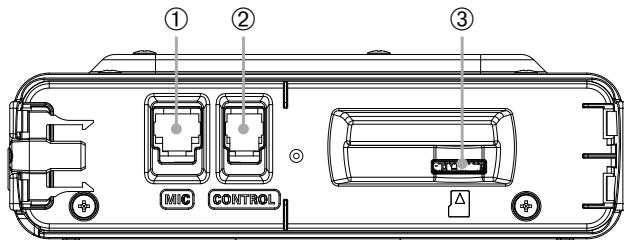

- ① CONTROL jack
Plug in the control cable into this jack to connect with the controller.
- ② MIC jack
Plug in the provided microphone cable.
- ③ micro-SD card slot

Back

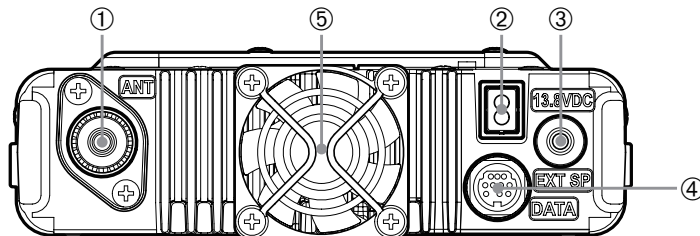

- ① ANT terminal
Connect the co-axial cable for the antenna.
- ② 13.8 VDC
Connect the provided DC power supply cable (with fuse attached).
- ③ EXT SP jack
Connect the optional external speaker.
- ④ DATA jack
Connect a cable for remote operation or the cable for connecting with the personal computer interface unit and the external terminal unit.
- ⑤ Cooling fan

Before Using

Name and Function of Each Component

Microphone (MH-48A6JA)

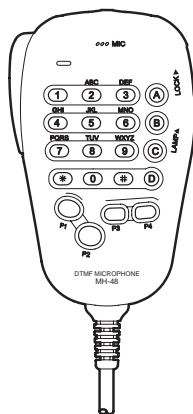
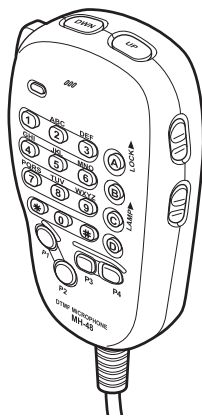

- [UP]** Frequency is increased by 1 step.
- [DWN]** Frequency is decreased by 1 step.
- [LOCK]** Locks / unlocks the [UP] and [DWN] keys and [P1] to [P4] keys.
- [LAMP]** Turns the lamp on the body of the microphone on/off.
- [MIC]** Speak into here during transmission.
- [1] to [0]** Enters the numbers and letters.
- [*]** Changes the VFO/Memory operating mode of the operating band.
- [#]** Activates the GM (Group Monitor) functions.
- [A]** Switches the operating band to Band A.
- [B]** Switches the operating band to Band B.
- [C]** Adjusts the squelch level.
- [D]** Switches the display.
- [P1]** Turns off the squelch (T.CALL: European version).
- [P2]** Recalls the receiver home channel.
- [P3]** Changes the communication mode.
- [P4]** Changes the transmit power.
- [PTT]** Press this key to begin the transmit mode.

Tip

Preferred functions can be assigned to buttons [P1] to [P4]. Select using the **[CONFIG]** → **[10 MIC PROGRAM KEY]** in the set-up menu.

Name and Function of Each Component

Explanation of the screen

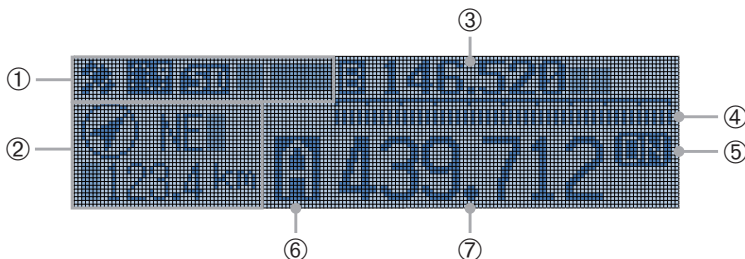

- ① Icon display
 Displays the Bluetooth, APRS, microSD card and GPS icons when each function is in use.
- ② Station location information display
 Displays the partner station location information and your location information. Briefly pressing the **[GPS]** key each time switches the information to display.
- ③ Sub-band frequency display
 Displays the sub-band name (A or B) and sub-band frequency.
- ④ SQL level display
- ⑤ Communication mode display
 Displays the mode name such as analog and digital using abbreviations. While in Auto mode, a bar appears and flashes above the abbreviation display. In Auto mode, the communication mode is automatically set according to the receiving signal.
- ⑥ Operating band name/memory channel/transmission power
 Displays the operating band name (A or B) in VFO mode.
 Displays ■■■ and the memory channel number in memory mode.
 Displays ■■■■ for "LO" and ■■■■■ for "MID".
- ⑦ Frequency display
 Displays the operating band frequency.

● GPS INFO screen

When the partner information is displayed, briefly press the **[GPS]** key twice to display the GPS INFO screen.

The GPS satellite reception status is displayed. ○ appears when the receiving signal is weak whereas ● appears when the receiving signal is strong.

Tip From [1 DISPLAY] → [4 GPS INFO], you can select "LOCATION" (location display) or "FREQUENCY" (frequency display).

Before Using

Installing the Radio

Precautions during installation

Note the following when installing this radio.

- Do not install the radio in a place where there is extreme vibration, where there is a lot of dust, excessive humidity or high temperature, or where it is exposed to direct sunlight.
- Install the radio in a well ventilated position, so heat release is not obstructed because the heat sink gets hot when transmitting for a long periods of time.
- Do not place any objects on top of the main body.
- Do not lift up or hold the controller by holding the knob or control cable.
- A regulated, negative ground 13.8 V DC power supply is required for this radio. Check that the car battery is a negative ground 12 V system when using this radio in a mobile unit. Never connect this radio to the 24 V battery of a large vehicle.
- Never connect this radio to a 120 V AC power source.
- Note that there is a risk that hum and noise may be introduced, depending on the installation condition and the external power source used.
- Install the device as far away as possible from the TV and radio to avoid TV and radio interference (TVI, BCI).
In particular, do not install this radio near indoor antenna elements.

About the antenna

A good antenna installation is extremely important for transmission and reception purposes. Note the following, as the type and characteristics of the antenna largely determines whether the performance of the radio can be fully realized.

- Use an antenna that suits the installation conditions and application objective.
- Use an antenna that suits the operating frequency band.
- Use an antenna and a co-axial cable with a characteristic impedance of 50Ω.
- Adjust the VSWR (standing wave ratio) until it is 1.5 or less for an antenna with an adjusted impedance of 50Ω.
- Keep the co-axial cable routing length as short as possible.

Install the antenna

● Antenna installation in a mobile unit

Mount the antenna base at the rear of the car (rear bumper, trunk, rear gate, etc.) and then attach the antenna to the base.

Cautions

- Ensure that the antenna base is securely grounded to the car body.
- Avoid routing the co-axial cable enclosed with a commercial car antenna cable.
- Do not allow rain water or moisture to penetrate the cable or connectors when laying the co-axial cable inside the car.

Installing the Radio

Bumper type

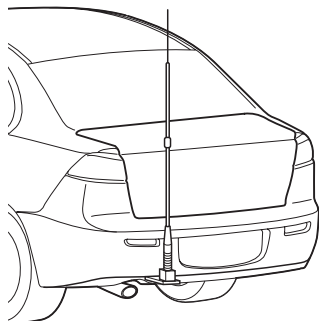

Trunk type

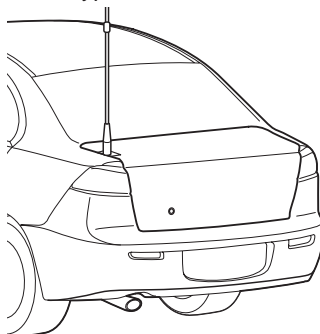

● Antenna installation in a fixed station

There are omni-directional, and directed array antennas for use in an outdoor setting.

- Omni-directional antennas such as the GP (Ground Plane) antenna are suitable for communications between a local station and mobile stations in all direction.
- Directional antennas such as the Yagi antenna are suitable for communications between a base station and a remote station in a specific direction.

Cautions

- Create a loop (slack) in the co-axial cable directly underneath the antenna and fasten it so that the weight of the cable does not pull on the antenna or connector itself.
- Install the antenna taking into consideration the securing supports and how the guying wires are positioned, so that the antenna does not fall over or get blown away in strong winds.

GP antenna
<Veranda Mounted Example>

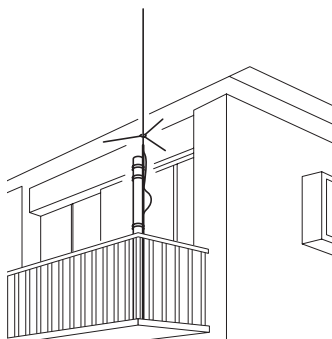

Yagi antenna
<Roof Mounted Example>

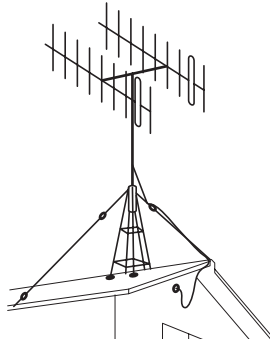

Installing the Radio

Installing the main body

Install the main body using the provided MMB-36 bracket.

1 Select the installation location

Caution Select a location where the antenna coax and power cable can be securely attached.

Tip Also refer to "Installation location when used in a mobile unit" (P.xx).

2 Drill four 6 mm diameter holes in the location where the bracket is to be mounted, matching the positions of the bolting holes of the bracket

3 Attach the bracket using the provided bolts, nuts and washers

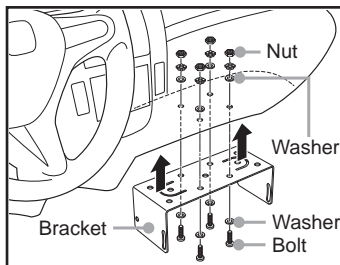

4 Fasten the main body to the bracket, using the provided flange bolts, as shown in the drawing

Tip The mounting angle can be changed depending on the securing position of the flange bolts.

