

This is a non-approved rough draft document. Do not share outside of SRAM. Procedures, illustrations, and technical information may not be correct and should not be used for any service or installation.

SRAM

ROCI[®]



Blips and BlipBox™

Blips/BlipBox™
User Manual

Blips/BlipBox™
Bedienungsanleitung

Manual de usuario
Blips/BlipBox™

Manuel d'entretien
Blips/BlipBox™

Manuale dell'Utente
Blip/BlipBox™

Blips/BlipBox™
Gebruiksaanwijzing

Manual do Utilizador
do Blips/BlipBox™

Blips/BlipBox™
ユーザー・マニュアル

Blips/BlipBox™ 用户手册

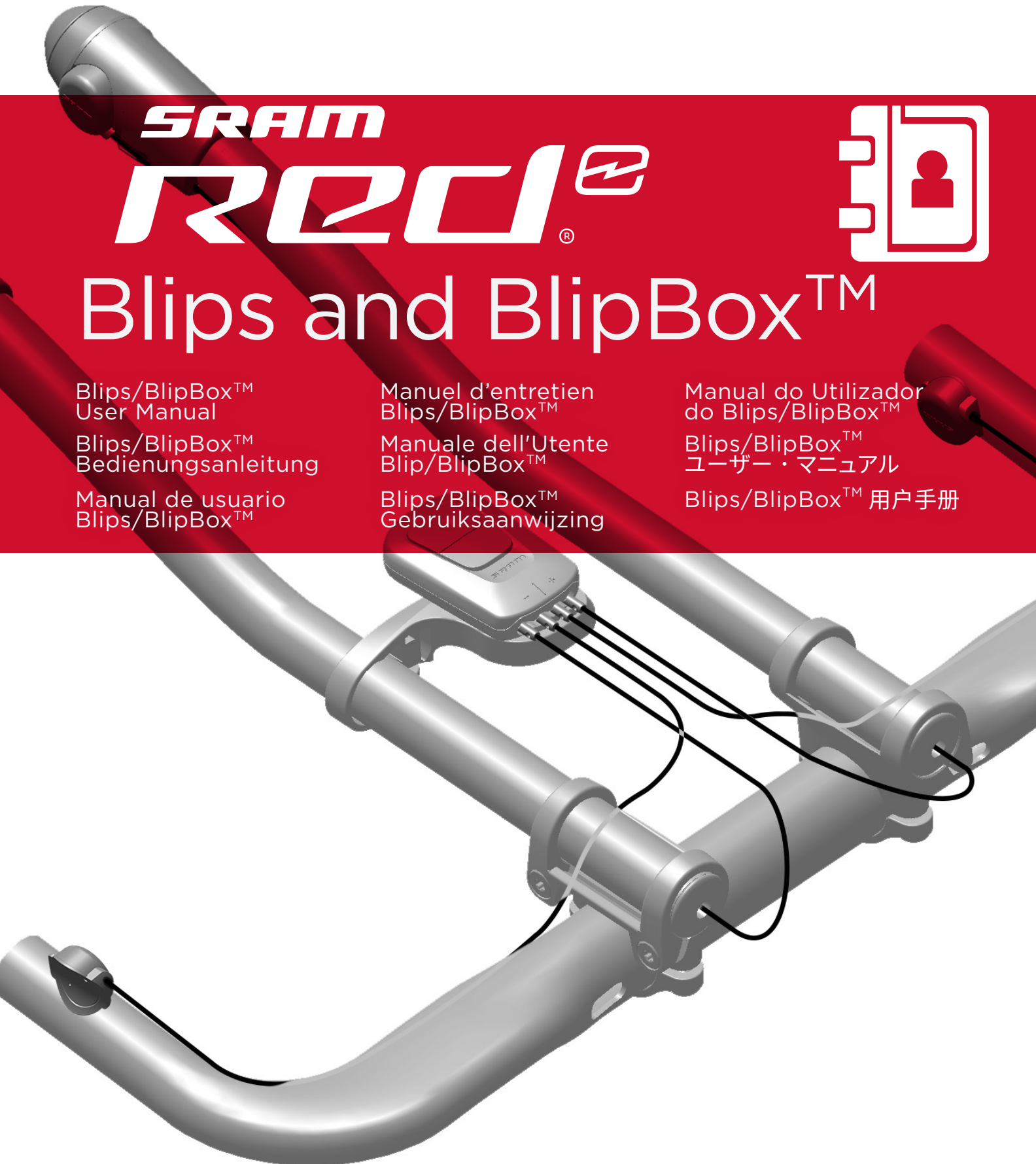

Tools and Supplies

Tools and Supplies
Tools and Supplies

Highly specialized tools and supplies are required for the installation of your SRAM components. We recommend that you have a qualified bicycle mechanic install your SRAM components.

Highly specialized tools and supplies are required for the installation of your SRAM components. We recommend that you have a qualified bicycle mechanic install your SRAM components.

Highly specialized tools and supplies are required for the installation of your SRAM components. We recommend that you have a qualified bicycle mechanic install your SRAM components.

Tools and Supplies
Tools and Supplies
Tools and Supplies

Highly specialized tools and supplies are required for the installation of your SRAM components. We recommend that you have a qualified bicycle mechanic install your SRAM components.

Highly specialized tools and supplies are required for the installation of your SRAM components. We recommend that you have a qualified bicycle mechanic install your SRAM components.

Highly specialized tools and supplies are required for the installation of your SRAM components. We recommend that you have a qualified bicycle mechanic install your SRAM components.

Tools and Supplies
Tools and Supplies
Tools and Supplies

Highly specialized tools and supplies are required for the installation of your SRAM components. We recommend that you have a qualified bicycle mechanic install your SRAM components.

Highly specialized tools and supplies are required for the installation of your SRAM components. We recommend that you have a qualified bicycle mechanic install your SRAM components.

Highly specialized tools and supplies are required for the installation of your SRAM components. We recommend that you have a qualified bicycle mechanic install your SRAM components.

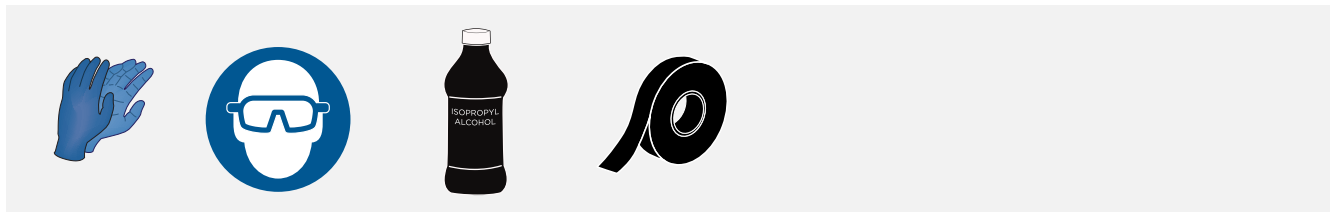

SAFETY INSTRUCTIONS

You must read and understand the safety and warranty document before proceeding with installation. Improperly installed components are extremely dangerous and could result in severe and/or fatal injuries. If you have any questions about the installation of these components, consult a qualified bicycle mechanic. This document is also available on www.sram.com.

SAFETY INSTRUCTIONS

You must read and understand the safety and warranty document before proceeding with installation. Improperly installed components are extremely dangerous and could result in severe and/or fatal injuries. If you have any questions about the installation of these components, consult a qualified bicycle mechanic. This document is also available on www.sram.com.

SAFETY INSTRUCTIONS

You must read and understand the safety and warranty document before proceeding with installation. Improperly installed components are extremely dangerous and could result in severe and/or fatal injuries. If you have any questions about the installation of these components, consult a qualified bicycle mechanic. This document is also available on www.sram.com.

SAFETY INSTRUCTIONS

You must read and understand the safety and warranty document before proceeding with installation. Improperly installed components are extremely dangerous and could result in severe and/or fatal injuries. If you have any questions about the installation of these components, consult a qualified bicycle mechanic. This document is also available on www.sram.com.

SAFETY INSTRUCTIONS

You must read and understand the safety and warranty document before proceeding with installation. Improperly installed components are extremely dangerous and could result in severe and/or fatal injuries. If you have any questions about the installation of these components, consult a qualified bicycle mechanic. This document is also available on www.sram.com.

SAFETY INSTRUCTIONS

You must read and understand the safety and warranty document before proceeding with installation. Improperly installed components are extremely dangerous and could result in severe and/or fatal injuries. If you have any questions about the installation of these components, consult a qualified bicycle mechanic. This document is also available on www.sram.com.

SAFETY INSTRUCTIONS

You must read and understand the safety and warranty document before proceeding with installation. Improperly installed components are extremely dangerous and could result in severe and/or fatal injuries. If you have any questions about the installation of these components, consult a qualified bicycle mechanic. This document is also available on www.sram.com.

SAFETY INSTRUCTIONS

You must read and understand the safety and warranty document before proceeding with installation. Improperly installed components are extremely dangerous and could result in severe and/or fatal injuries. If you have any questions about the installation of these components, consult a qualified bicycle mechanic. This document is also available on www.sram.com.

SAFETY INSTRUCTIONS

You must read and understand the safety and warranty document before proceeding with installation. Improperly installed components are extremely dangerous and could result in severe and/or fatal injuries. If you have any questions about the installation of these components, consult a qualified bicycle mechanic. This document is also available on www.sram.com.

Product Registration

Product Registration
Product Registration

Product Registration
Product Registration
Product Registration

Product Registration
Product Registration
Product Registration

For software updates and information related to your products, please register online at www.sram.com/registration.

For software updates and information related to your products, please register online at www.sram.com/registration.

For software updates and information related to your products, please register online at www.sram.com/registration.

For software updates and information related to your products, please register online at www.sram.com/registration.



For software updates and information related to your products, please register online at www.sram.com/registration.



For software updates and information related to your products, please register online at www.sram.com/registration.



For software updates and information related to your products, please register online at www.sram.com/registration.



For software updates and information related to your products, please register online at www.sram.com/registration.



For software updates and information related to your products, please register online at www.sram.com/registration.



The BlipBox wirelessly pairs to each derailleur, sends shift signals to the front and rear derailleurs when the Blips are pressed, and shifts the derailleurs when the ,  and  buttons are pressed. The BlipBox is not required when the Blips are connected to eTap™ road shifters.



The BlipBox wirelessly pairs to each derailleur, sends shift signals to the front and rear derailleurs when the Blips are pressed, and shifts the derailleurs when the ,  and  buttons are pressed. The BlipBox is not required when the Blips are connected to eTap™ road shifters.



The BlipBox wirelessly pairs to each derailleur, sends shift signals to the front and rear derailleurs when the Blips are pressed, and shifts the derailleurs when the ,  and  buttons are pressed. The BlipBox is not required when the Blips are connected to eTap™ road shifters.



The BlipBox wirelessly pairs to each derailleur, sends shift signals to the front and rear derailleurs when the Blips are pressed, and shifts the derailleurs when the ,  and  buttons are pressed. The BlipBox is not required when the Blips are connected to eTap™ road shifters.

The BlipBox wirelessly pairs to each derailleur, sends shift signals to the front and rear derailleurs when the Blips are pressed, and shifts the derailleurs when the ,  and  buttons are pressed. The BlipBox is not required when the Blips are connected to eTap™ road shifters.

The BlipBox wirelessly pairs to each derailleur, sends shift signals to the front and rear derailleurs when the Blips are pressed, and shifts the derailleurs when the ,  and  buttons are pressed. The BlipBox is not required when the Blips are connected to eTap™ road shifters.

The BlipBox wirelessly pairs to each derailleur, sends shift signals to the front and rear derailleurs when the Blips are pressed, and shifts the derailleurs when the ,  and  buttons are pressed. The BlipBox is not required when the Blips are connected to eTap™ road shifters.

The BlipBox wirelessly pairs to each derailleur, sends shift signals to the front and rear derailleurs when the Blips are pressed, and shifts the derailleurs when the ,  and  buttons are pressed. The BlipBox is not required when the Blips are connected to eTap™ road shifters.

The BlipBox wirelessly pairs to each derailleur, sends shift signals to the front and rear derailleurs when the Blips are pressed, and shifts the derailleurs when the ,  and buttons are pressed. The BlipBox is not required when the Blips are connected to eTap™ road shifters.





- (a) LED
- (b) Rear derailleur inboard shift
- (c) Rear derailleur outboard shift
- (d) Front derailleur shift
- (e) Pairs BlipBox to each derailleur
- (f) Wire input, left Blips
- (g) Wire input, right Blips

- (a) LED
- (b) Rear derailleur inboard shift
- (c) Rear derailleur outboard shift
- (d) Front derailleur shift
- (e) Pairs BlipBox to each derailleur
- (f) Wire input, left Blips
- (g) Wire input, right Blips

- (a) LED
- (b) Rear derailleur inboard shift
- (c) Rear derailleur outboard shift
- (d) Front derailleur shift
- (e) Pairs BlipBox to each derailleur
- (f) Wire input, left Blips
- (g) Wire input, right Blips

- (a) LED
- (b) Rear derailleur inboard shift
- (c) Rear derailleur outboard shift
- (d) Front derailleur shift
- (e) Pairs BlipBox to each derailleur
- (f) Wire input, left Blips
- (g) Wire input, right Blips

- (a) LED
- (b) Rear derailleur inboard shift
- (c) Rear derailleur outboard shift
- (d) Front derailleur shift
- (e) Pairs BlipBox to each derailleur
- (f) Wire input, left Blips
- (g) Wire input, right Blips

- (a) LED
- (b) Rear derailleur inboard shift
- (c) Rear derailleur outboard shift
- (d) Front derailleur shift
- (e) Pairs BlipBox to each derailleur
- (f) Wire input, left Blips
- (g) Wire input, right Blips

- (a) LED
- (b) Rear derailleur inboard shift
- (c) Rear derailleur outboard shift
- (d) Front derailleur shift
- (e) Pairs BlipBox to each derailleur
- (f) Wire input, left Blips
- (g) Wire input, right Blips

- (a) LED
- (b) Rear derailleur inboard shift
- (c) Rear derailleur outboard shift
- (d) Front derailleur shift
- (e) Pairs BlipBox to each derailleur
- (f) Wire input, left Blips
- (g) Wire input, right Blips

- (a) LED
- (b) Rear derailleur inboard shift
- (c) Rear derailleur outboard shift
- (d) Front derailleur shift
- (e) Pairs BlipBox to each derailleur
- (f) Wire input, left Blips
- (g) Wire input, right Blips



Remove the dummy plugs from the BlipBox.

NOTICE

Do not discard the dummy plugs. Reinstall if Blip connector wire is removed.

WARNING

Do not use or clean the BlipBox or eTap shifters without connector wires or dummy plugs installed. Moisture will damage the BlipBox and eTap shifters.

Remove the dummy plugs from the BlipBox.

NOTICE

Do not discard the dummy plugs. Reinstall if Blip connector wire is removed.

WARNING

Do not use or clean the BlipBox or eTap shifters without connector wires or dummy plugs installed. Moisture will damage the BlipBox and eTap shifters.

Remove the dummy plugs from the BlipBox.

NOTICE

Do not discard the dummy plugs. Reinstall if Blip connector wire is removed.

WARNING

Do not use or clean the BlipBox or eTap shifters without connector wires or dummy plugs installed. Moisture will damage the BlipBox and eTap shifters.

Remove the dummy plugs from the BlipBox.

NOTICE

Do not discard the dummy plugs. Reinstall if Blip connector wire is removed.

WARNING

Do not use or clean the BlipBox or eTap shifters without connector wires or dummy plugs installed. Moisture will damage the BlipBox and eTap shifters.

Remove the dummy plugs from the BlipBox.

NOTICE

Do not discard the dummy plugs. Reinstall if Blip connector wire is removed.

WARNING

Do not use or clean the BlipBox or eTap shifters without connector wires or dummy plugs installed. Moisture will damage the BlipBox and eTap shifters.

Remove the dummy plugs from the BlipBox.

NOTICE

Do not discard the dummy plugs. Reinstall if Blip connector wire is removed.

WARNING

Do not use or clean the BlipBox or eTap shifters without connector wires or dummy plugs installed. Moisture will damage the BlipBox and eTap shifters.

Remove the dummy plugs from the BlipBox.

NOTICE

Do not discard the dummy plugs. Reinstall if Blip connector wire is removed.

WARNING

Do not use or clean the BlipBox or eTap shifters without connector wires or dummy plugs installed. Moisture will damage the BlipBox and eTap shifters.

Remove the dummy plugs from the BlipBox.

NOTICE

Do not discard the dummy plugs. Reinstall if Blip connector wire is removed.

WARNING

Do not use or clean the BlipBox or eTap shifters without connector wires or dummy plugs installed. Moisture will damage the BlipBox and eTap shifters.

Remove the dummy plugs from the BlipBox.

NOTICE

Do not discard the dummy plugs. Reinstall if Blip connector wire is removed.

WARNING

Do not use or clean the BlipBox or eTap shifters without connector wires or dummy plugs installed. Moisture will damage the BlipBox and eTap shifters.

BlipBox Mounts

BlipBox Mounts
BlipBox Mounts

BlipBox Mounts
BlipBox Mounts
BlipBox Mounts

BlipBox Mounts
BlipBox Mounts
BlipBox Mounts

Bar Extension Mount

Bar Extension Mount
Bar Extension Mount

Bar Extension Mount
Bar Extension Mount
Bar Extension Mount

Bar Extension Mount
Bar Extension Mount
Bar Extension Mount

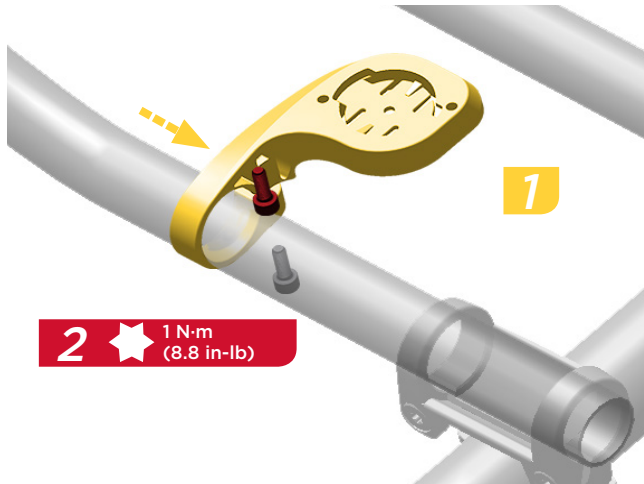

Install the mount onto the aero bar extension.

Install the mount onto the aero bar extension.

Install the mount onto the aero bar extension.

Install the mount onto the aero bar extension.

Install the mount onto the aero bar extension.

Install the mount onto the aero bar extension.

Install the mount onto the aero bar extension.

Install the mount onto the aero bar extension.

Install the mount onto the aero bar extension.

Install the BlipBox onto the mount.

Install the BlipBox onto the mount.

Install the BlipBox onto the mount.

Install the BlipBox onto the mount.

Install the BlipBox onto the mount.

Install the BlipBox onto the mount.

Install the BlipBox onto the mount.

Install the BlipBox onto the mount.

Install the BlipBox onto the mount.

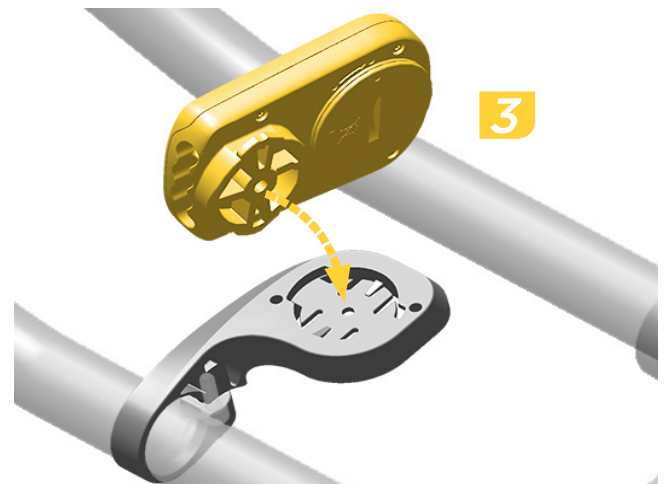

Twist the BlipBox one quarter turn to lock into place.

Twist the BlipBox one quarter turn to lock into place.

Twist the BlipBox one quarter turn to lock into place.

Twist the BlipBox one quarter turn to lock into place.

Twist the BlipBox one quarter turn to lock into place.

Twist the BlipBox one quarter turn to lock into place.

Twist the BlipBox one quarter turn to lock into place.

Twist the BlipBox one quarter turn to lock into place.

Twist the BlipBox one quarter turn to lock into place.



Stem Mounts

Stem Mounts
Stem Mounts
Stem Mounts

Stem Mounts
Stem Mounts
Stem Mounts

Stem Mounts
Stem Mounts
Stem Mounts



Flat Mount
Flat Mount
Flat Mount



Flat Mount
Flat Mount
Flat Mount

Flat Mount
Flat Mount
Flat Mount



Curved Mount
Curved Mount
Curved Mount



Curved Mount
Curved Mount
Curved Mount

Curved Mount
Curved Mount
Curved Mount



Rubber Band Mount
Rubber Band Mount
Rubber Band Mount



Rubber Band Mount
Rubber Band Mount
Rubber Band Mount



Rubber Band Mount
Rubber Band Mount
Rubber Band Mount

Adhesive

Adhesive
Adhesive
Adhesive

Adhesive
Adhesive
Adhesive

Adhesive
Adhesive
Adhesive



Attach the adhesive tab to the back of the flat or curved puck mount and remove the paper backing.

Attach the adhesive tab to the back of the flat or curved puck mount and remove the paper backing.

Attach the adhesive tab to the back of the flat or curved puck mount and remove the paper backing.



Attach the adhesive tab to the back of the flat or curved puck mount and remove the paper backing.

Attach the adhesive tab to the back of the flat or curved puck mount and remove the paper backing.

Attach the adhesive tab to the back of the flat or curved puck mount and remove the paper backing.



Attach the adhesive tab to the back of the flat or curved puck mount and remove the paper backing.

Attach the adhesive tab to the back of the flat or curved puck mount and remove the paper backing.

Attach the adhesive tab to the back of the flat or curved puck mount and remove the paper backing.

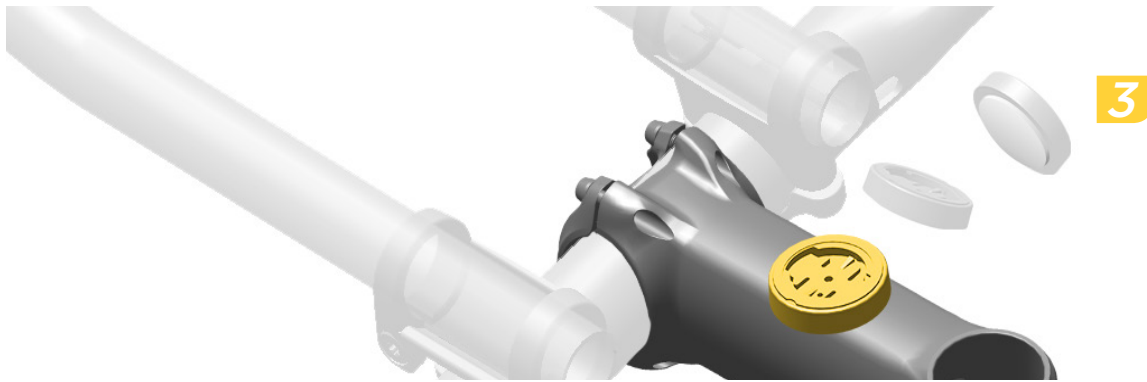

Position the mount in the desired location and press down to attach.

NOTICE

Clean the stem surface with isopropyl alcohol before attaching the mount.

Position the mount in the desired location and press down to attach.

NOTICE

Clean the stem surface with isopropyl alcohol before attaching the mount.

Position the mount in the desired location and press down to attach.

NOTICE

Clean the stem surface with isopropyl alcohol before attaching the mount.

Position the mount in the desired location and press down to attach.

NOTICE

Clean the stem surface with isopropyl alcohol before attaching the mount.

Position the mount in the desired location and press down to attach.

NOTICE

Clean the stem surface with isopropyl alcohol before attaching the mount.

Position the mount in the desired location and press down to attach.

NOTICE

Clean the stem surface with isopropyl alcohol before attaching the mount.

Position the mount in the desired location and press down to attach.

NOTICE

Clean the stem surface with isopropyl alcohol before attaching the mount.

Position the mount in the desired location and press down to attach.

NOTICE

Clean the stem surface with isopropyl alcohol before attaching the mount.

Position the mount in the desired location and press down to attach.

NOTICE

Clean the stem surface with isopropyl alcohol before attaching the mount.



Install
Einbauen
Installare
Instalación

Installer
Installare
Monteren

Instalar
取り付け
安装



Remove
Entfernen
Quitar

Retirer
Rimuovere
Verwijderen

Retirar
取り外し
拆卸

Rubber Band

Rubber Band
Rubber Band
Rubber Band

Rubber Band
Rubber Band
Rubber Band

Rubber Band
Rubber Band
Rubber Band



Position the mount onto the stem in the desired location.

Position the mount onto the stem in the desired location.

Position the mount onto the stem in the desired location.

Position the mount onto the stem in the desired location.

Position the mount onto the stem in the desired location.

Position the mount onto the stem in the desired location.

Position the mount onto the stem in the desired location.

Position the mount onto the stem in the desired location.

Position the mount onto the stem in the desired location.



Attach the mount to the stem with the included rubber bands.

Attach the mount to the stem with the included rubber bands.

Attach the mount to the stem with the included rubber bands.

Attach the mount to the stem with the included rubber bands.

Attach the mount to the stem with the included rubber bands.

Attach the mount to the stem with the included rubber bands.

Attach the mount to the stem with the included rubber bands.

Attach the mount to the stem with the included rubber bands.

Attach the mount to the stem with the included rubber bands.



Install
Einbauen
Instalación

Installer
Installare
Monteren

Instalar
取り付け
安装

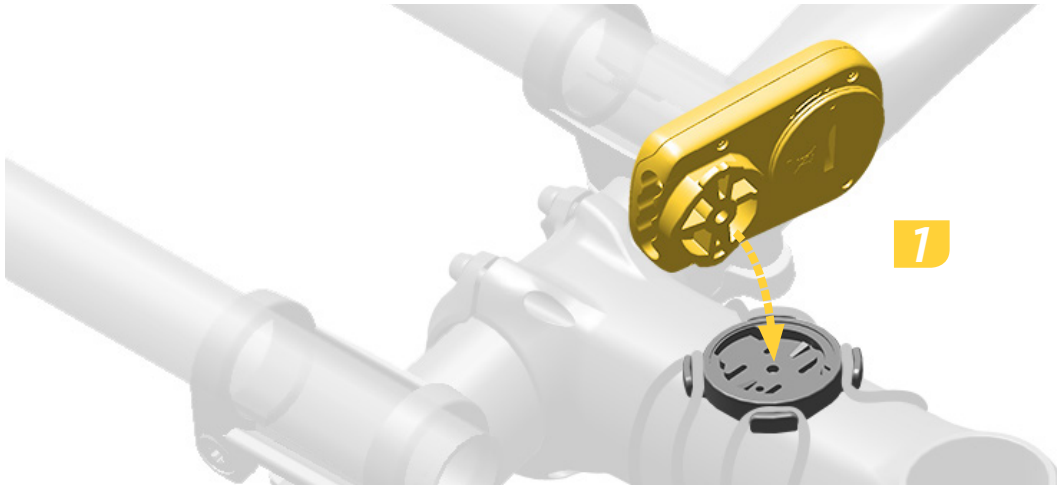

Install the BlipBox onto the mount.

Install the BlipBox onto the mount.

Install the BlipBox onto the mount.

Install the BlipBox onto the mount.

Install the BlipBox onto the mount.

Install the BlipBox onto the mount.

Install the BlipBox onto the mount.

Install the BlipBox onto the mount.

Install the BlipBox onto the mount.



Twist the BlipBox one quarter turn to lock into place.

Twist the BlipBox one quarter turn to lock into place.

Twist the BlipBox one quarter turn to lock into place.

Twist the BlipBox one quarter turn to lock into place.

Twist the BlipBox one quarter turn to lock into place.

Twist the BlipBox one quarter turn to lock into place.

Twist the BlipBox one quarter turn to lock into place.

Twist the BlipBox one quarter turn to lock into place.

Twist the BlipBox one quarter turn to lock into place.

Blips

Blips
Blips

Blips
Blips
Blips

Blips
Blips
Blips

Each Blip satellite shifter actuates a derailleur shift, inboard or outboard, when the button is pressed. Each Blip connects via connector wire to either the BlipBox or an eTap™ road shifter which is wirelessly paired to each derailleur. The BlipBox or eTap™ shifter transmit the shift signal to each derailleur to execute the gear shift.

Each Blip satellite shifter actuates a derailleur shift, inboard or outboard, when the button is pressed. Each Blip connects via connector wire to either the BlipBox or an eTap™ road shifter which is wirelessly paired to each derailleur. The BlipBox or eTap™ shifter transmit the shift signal to each derailleur to execute the gear shift.

Each Blip satellite shifter actuates a derailleur shift, inboard or outboard, when the button is pressed. Each Blip connects via connector wire to either the BlipBox or an eTap™ road shifter which is wirelessly paired to each derailleur. The BlipBox or eTap™ shifter transmit the shift signal to each derailleur to execute the gear shift.

Each Blip satellite shifter actuates a derailleur shift, inboard or outboard, when the button is pressed. Each Blip connects via connector wire to either the BlipBox or an eTap™ road shifter which is wirelessly paired to each derailleur. The BlipBox or eTap™ shifter transmit the shift signal to each derailleur to execute the gear shift.

Each Blip satellite shifter actuates a derailleur shift, inboard or outboard, when the button is pressed. Each Blip connects via connector wire to either the BlipBox or an eTap™ road shifter which is wirelessly paired to each derailleur. The BlipBox or eTap™ shifter transmit the shift signal to each derailleur to execute the gear shift.

Each Blip satellite shifter actuates a derailleur shift, inboard or outboard, when the button is pressed. Each Blip connects via connector wire to either the BlipBox or an eTap™ road shifter which is wirelessly paired to each derailleur. The BlipBox or eTap™ shifter transmit the shift signal to each derailleur to execute the gear shift.

Each Blip satellite shifter actuates a derailleur shift, inboard or outboard, when the button is pressed. Each Blip connects via connector wire to either the BlipBox or an eTap™ road shifter which is wirelessly paired to each derailleur. The BlipBox or eTap™ shifter transmit the shift signal to each derailleur to execute the gear shift.

Each Blip satellite shifter actuates a derailleur shift, inboard or outboard, when the button is pressed. Each Blip connects via connector wire to either the BlipBox or an eTap™ road shifter which is wirelessly paired to each derailleur. The BlipBox or eTap™ shifter transmit the shift signal to each derailleur to execute the gear shift.

Each Blip satellite shifter actuates a derailleur shift, inboard or outboard, when the button is pressed. Each Blip connects via connector wire to either the BlipBox or an eTap™ road shifter which is wirelessly paired to each derailleur. The BlipBox or eTap™ shifter transmit the shift signal to each derailleur to execute the gear shift.

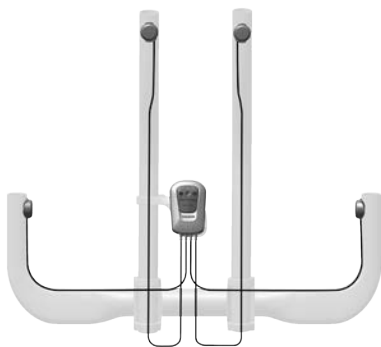

NOTICE

Measure the length of wire required and select the appropriate Blip wire length before installing the Blip.

To avoid damage to wires, avoid sharp bends.

Secure wires to the handlebar with electrical tape.

Secure any loose wires together.

Wrap bar tape over the wires.

It is ok to wrap bar tape over Blips.

NOTICE

Measure the length of wire required and select the appropriate Blip wire length before installing the Blip.

To avoid damage to wires, avoid sharp bends.

Secure wires to the handlebar with electrical tape.

Secure any loose wires together.

Wrap bar tape over the wires.

It is ok to wrap bar tape over Blips.

NOTICE

Measure the length of wire required and select the appropriate Blip wire length before installing the Blip.

To avoid damage to wires, avoid sharp bends.

Secure wires to the handlebar with electrical tape.

Secure any loose wires together.

Wrap bar tape over the wires.

It is ok to wrap bar tape over Blips.

NOTICE

Measure the length of wire required and select the appropriate Blip wire length before installing the Blip.

To avoid damage to wires, avoid sharp bends.

Secure wires to the handlebar with electrical tape.

Secure any loose wires together.

Wrap bar tape over the wires.

It is ok to wrap bar tape over Blips.

NOTICE

Measure the length of wire required and select the appropriate Blip wire length before installing the Blip.

To avoid damage to wires, avoid sharp bends.

Secure wires to the handlebar with electrical tape.

Secure any loose wires together.

Wrap bar tape over the wires.

It is ok to wrap bar tape over Blips.

NOTICE

Measure the length of wire required and select the appropriate Blip wire length before installing the Blip.

To avoid damage to wires, avoid sharp bends.

Secure wires to the handlebar with electrical tape.

Secure any loose wires together.

Wrap bar tape over the wires.

It is ok to wrap bar tape over Blips.

NOTICE

Measure the length of wire required and select the appropriate Blip wire length before installing the Blip.

To avoid damage to wires, avoid sharp bends.

Secure wires to the handlebar with electrical tape.

Secure any loose wires together.

Wrap bar tape over the wires.

It is ok to wrap bar tape over Blips.

NOTICE

Measure the length of wire required and select the appropriate Blip wire length before installing the Blip.

To avoid damage to wires, avoid sharp bends.

Secure wires to the handlebar with electrical tape.

Secure any loose wires together.

Wrap bar tape over the wires.

It is ok to wrap bar tape over Blips.

NOTICE

Measure the length of wire required and select the appropriate Blip wire length before installing the Blip.

To avoid damage to wires, avoid sharp bends.

Secure wires to the handlebar with electrical tape.

Secure any loose wires together.

Wrap bar tape over the wires.

It is ok to wrap bar tape over Blips.

Bar Extension

Bar Extension
Bar Extension
Bar Extension

Bar Extension
Bar Extension
Bar Extension

Bar Extension
Bar Extension
Bar Extension

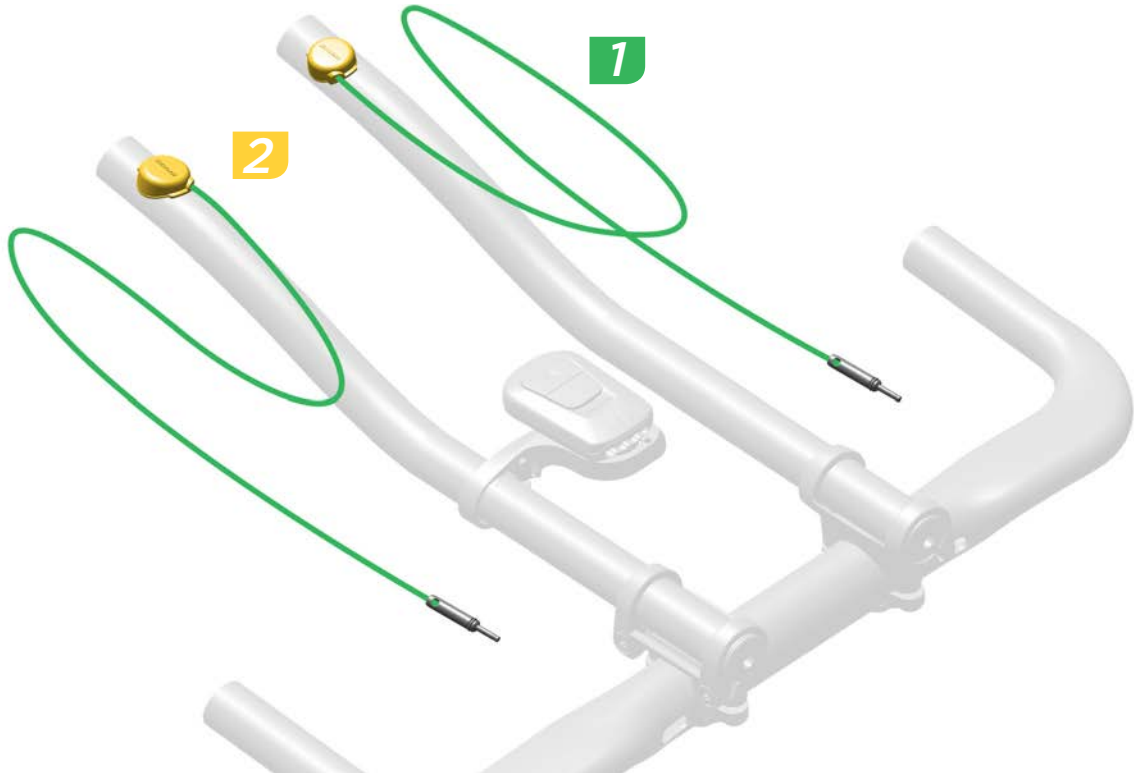

Clean the bar extension with isopropyl alcohol.

Attach the Blip to the bar with the adhesive tab in the desired ergonomic position.

NOTICE

The Blip can be located anywhere on the bar extension.

Clean the bar extension with isopropyl alcohol.

Attach the Blip to the bar with the adhesive tab in the desired ergonomic position.

NOTICE

The Blip can be located anywhere on the bar extension.

Clean the bar extension with isopropyl alcohol.

Attach the Blip to the bar with the adhesive tab in the desired ergonomic position.

NOTICE

The Blip can be located anywhere on the bar extension.

Clean the bar extension with isopropyl alcohol.

Attach the Blip to the bar with the adhesive tab in the desired ergonomic position.

NOTICE

The Blip can be located anywhere on the bar extension.

Clean the bar extension with isopropyl alcohol.

Attach the Blip to the bar with the adhesive tab in the desired ergonomic position.

NOTICE

The Blip can be located anywhere on the bar extension.

Clean the bar extension with isopropyl alcohol.

Attach the Blip to the bar with the adhesive tab in the desired ergonomic position.

NOTICE

The Blip can be located anywhere on the bar extension.

Clean the bar extension with isopropyl alcohol.

Attach the Blip to the bar with the adhesive tab in the desired ergonomic position.

NOTICE

The Blip can be located anywhere on the bar extension.

Clean the bar extension with isopropyl alcohol.

Attach the Blip to the bar with the adhesive tab in the desired ergonomic position.

NOTICE

The Blip can be located anywhere on the bar extension.

Clean the bar extension with isopropyl alcohol.

Attach the Blip to the bar with the adhesive tab in the desired ergonomic position.

NOTICE

The Blip can be located anywhere on the bar extension.

Blip Grip

Blip Grip
Blip Grip
Blip Grip

Blip Grip
Blip Grip
Blip Grip

Blip Grip
Blip Grip
Blip Grip

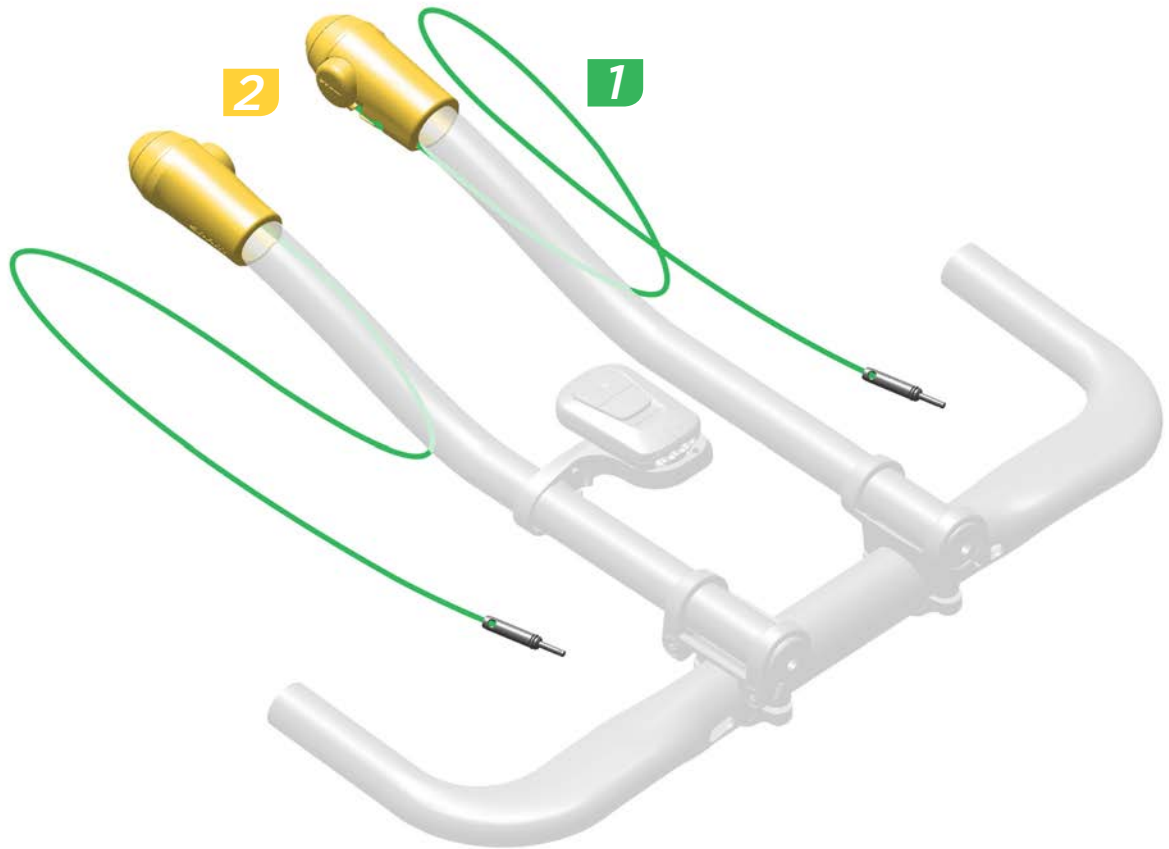

Install each BlipGrip onto each bar extension.

Install each BlipGrip onto each bar extension.

Install each BlipGrip onto each bar extension.

Install each BlipGrip onto each bar extension.

Install each BlipGrip onto each bar extension.

Install each BlipGrip onto each bar extension.

Install each BlipGrip onto each bar extension.

Install each BlipGrip onto each bar extension.

Install each BlipGrip onto each bar extension.



Measure
Messen
Medir

Mesurer
Misurare
Meten

Medir
計測
測量



Install
Einbauen
Instalación

Installer
Installare
Monteren

Instalar
取り付け
安装

2



Rotate and adjust each BlipGrip to the desired ergonomic position.

Rotate and adjust each BlipGrip to the desired ergonomic position.

Rotate and adjust each BlipGrip to the desired ergonomic position.

Rotate and adjust each BlipGrip to the desired ergonomic position.

Rotate and adjust each BlipGrip to the desired ergonomic position.

Rotate and adjust each BlipGrip to the desired ergonomic position.

Rotate and adjust each BlipGrip to the desired ergonomic position.

Rotate and adjust each BlipGrip to the desired ergonomic position.

Rotate and adjust each BlipGrip to the desired ergonomic position.



3 0.23 N-m (2.0 in-lb)

Tighten each clamp bolt.

Tighten each clamp bolt.

Tighten each clamp bolt.

Tighten each clamp bolt.

Tighten each clamp bolt.

Tighten each clamp bolt.

Tighten each clamp bolt.

Tighten each clamp bolt.

Tighten each clamp bolt.



Adjust
Einstellen
Ajustar

Régler
Regolare
Afstellen

Ajustar
調節
調節



Torque
Drehmoment
Par de apriete

Serrage
Coppia
Aandrailmoment

Momento de torção
締め付け
扭緊

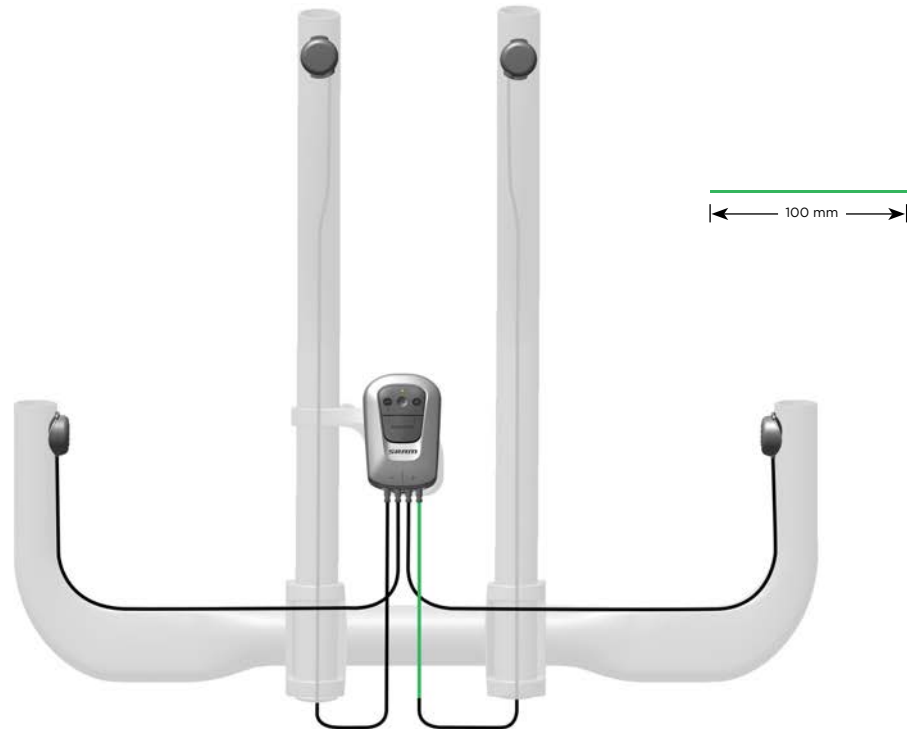
Blip WireBlip Wire
Blip WireBlip Wire
Blip Wire
Blip WireBlip Wire
Blip Wire
Blip Wire**NOTICE**

At least one Blip wire must have a minimum of 100 mm of uninterrupted exposed wire for proper signal transmission. Routing wires under bar tape does not hinder signal transmission and is acceptable. Before use, test for proper function.

NOTICE

At least one Blip wire must have a minimum of 100 mm of uninterrupted exposed wire for proper signal transmission. Routing wires under bar tape does not hinder signal transmission and is acceptable. Before use, test for proper function.

NOTICE

At least one Blip wire must have a minimum of 100 mm of uninterrupted exposed wire for proper signal transmission. Routing wires under bar tape does not hinder signal transmission and is acceptable. Before use, test for proper function.

NOTICE

At least one Blip wire must have a minimum of 100 mm of uninterrupted exposed wire for proper signal transmission. Routing wires under bar tape does not hinder signal transmission and is acceptable. Before use, test for proper function.

NOTICE

At least one Blip wire must have a minimum of 100 mm of uninterrupted exposed wire for proper signal transmission. Routing wires under bar tape does not hinder signal transmission and is acceptable. Before use, test for proper function.

NOTICE

At least one Blip wire must have a minimum of 100 mm of uninterrupted exposed wire for proper signal transmission. Routing wires under bar tape does not hinder signal transmission and is acceptable. Before use, test for proper function.

NOTICE

At least one Blip wire must have a minimum of 100 mm of uninterrupted exposed wire for proper signal transmission. Routing wires under bar tape does not hinder signal transmission and is acceptable. Before use, test for proper function.

NOTICE

At least one Blip wire must have a minimum of 100 mm of uninterrupted exposed wire for proper signal transmission. Routing wires under bar tape does not hinder signal transmission and is acceptable. Before use, test for proper function.

NOTICE

At least one Blip wire must have a minimum of 100 mm of uninterrupted exposed wire for proper signal transmission. Routing wires under bar tape does not hinder signal transmission and is acceptable. Before use, test for proper function.





1a



1b



1a



1b

Route each Blip wire from the end of the bar extension, internally (1a) or externally (1b), to the BlipBox. Plug each connector into the BlipBox; left \ominus , right \oplus .

Route each Blip wire from the end of the bar extension, internally (1a) or externally (1b), to the BlipBox. Plug each connector into the BlipBox; left \ominus , right \oplus .

Route each Blip wire from the end of the bar extension, internally (1a) or externally (1b), to the BlipBox. Plug each connector into the BlipBox; left \ominus , right \oplus .

Route each Blip wire from the end of the bar extension, internally (1a) or externally (1b), to the BlipBox. Plug each connector into the BlipBox; left \ominus , right \oplus .

Route each Blip wire from the end of the bar extension, internally (1a) or externally (1b), to the BlipBox. Plug each connector into the BlipBox; left \ominus , right \oplus .

Route each Blip wire from the end of the bar extension, internally (1a) or externally (1b), to the BlipBox. Plug each connector into the BlipBox; left \ominus , right \oplus .

Route each Blip wire from the end of the bar extension, internally (1a) or externally (1b), to the BlipBox. Plug each connector into the BlipBox; left \ominus , right \oplus .

Route each Blip wire from the end of the bar extension, internally (1a) or externally (1b), to the BlipBox. Plug each connector into the BlipBox; left \ominus , right \oplus .

Route each Blip wire from the end of the bar extension, internally (1a) or externally (1b), to the BlipBox. Plug each connector into the BlipBox; left \ominus , right \oplus .



Install
Einbauen
Instalación

Installer
Installare
Monteren

Instalar
取り付け
安装

Aero Bar

Aero Bar
Aero Bar

Aero Bar
Aero Bar
Aero Bar

Aero Bar
Aero Bar
Aero Bar

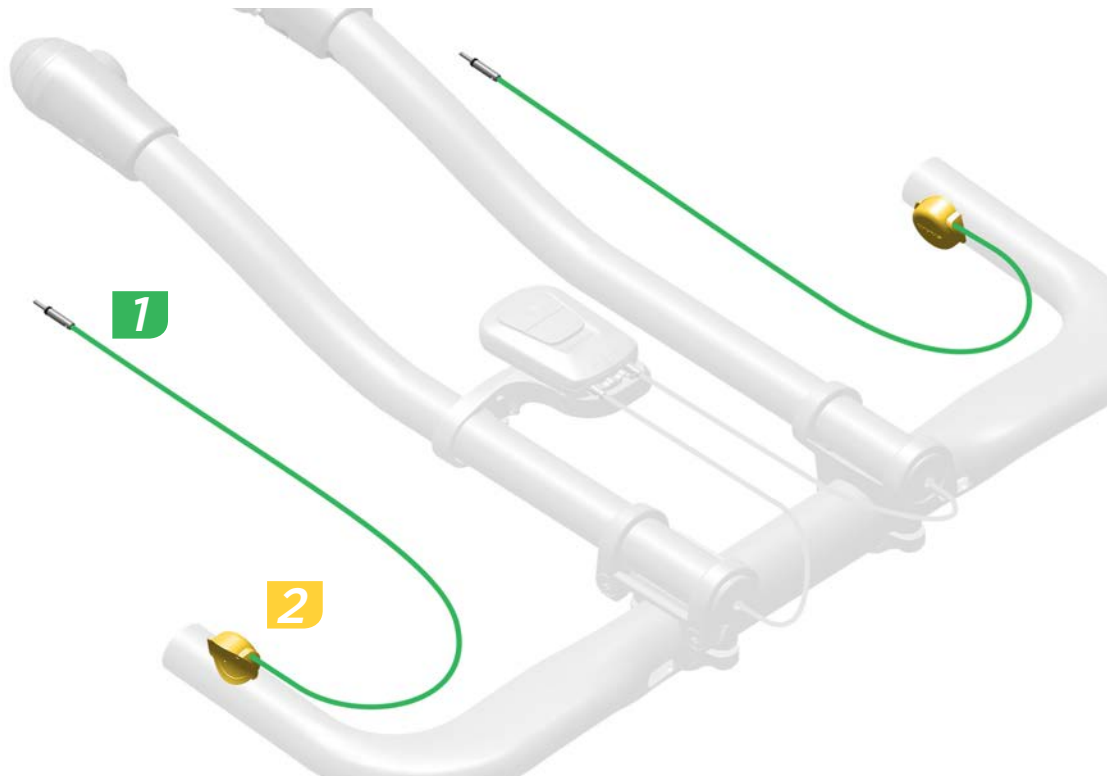

Clean the handlebar with isopropyl alcohol.

Attach the Blip to the handlebar with the adhesive tab in the desired ergonomic position.

Clean the handlebar with isopropyl alcohol.

Attach the Blip to the handlebar with the adhesive tab in the desired ergonomic position.

Clean the handlebar with isopropyl alcohol.

Attach the Blip to the handlebar with the adhesive tab in the desired ergonomic position.

Clean the handlebar with isopropyl alcohol.

Attach the Blip to the handlebar with the adhesive tab in the desired ergonomic position.

Clean the handlebar with isopropyl alcohol.

Attach the Blip to the handlebar with the adhesive tab in the desired ergonomic position.

Clean the handlebar with isopropyl alcohol.

Attach the Blip to the handlebar with the adhesive tab in the desired ergonomic position.

Clean the handlebar with isopropyl alcohol.

Attach the Blip to the handlebar with the adhesive tab in the desired ergonomic position.

Clean the handlebar with isopropyl alcohol.

Attach the Blip to the handlebar with the adhesive tab in the desired ergonomic position.

Clean the handlebar with isopropyl alcohol.

Attach the Blip to the handlebar with the adhesive tab in the desired ergonomic position.

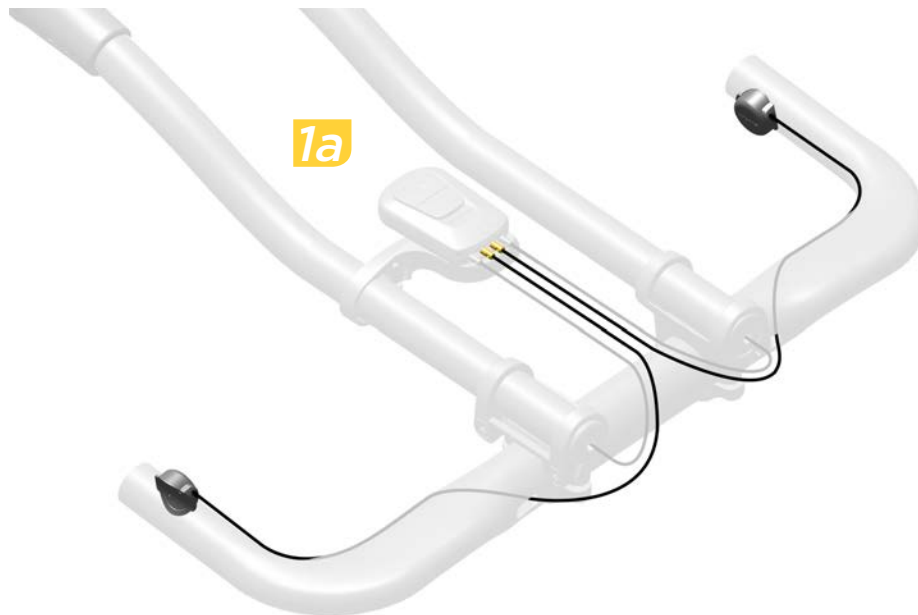

1a

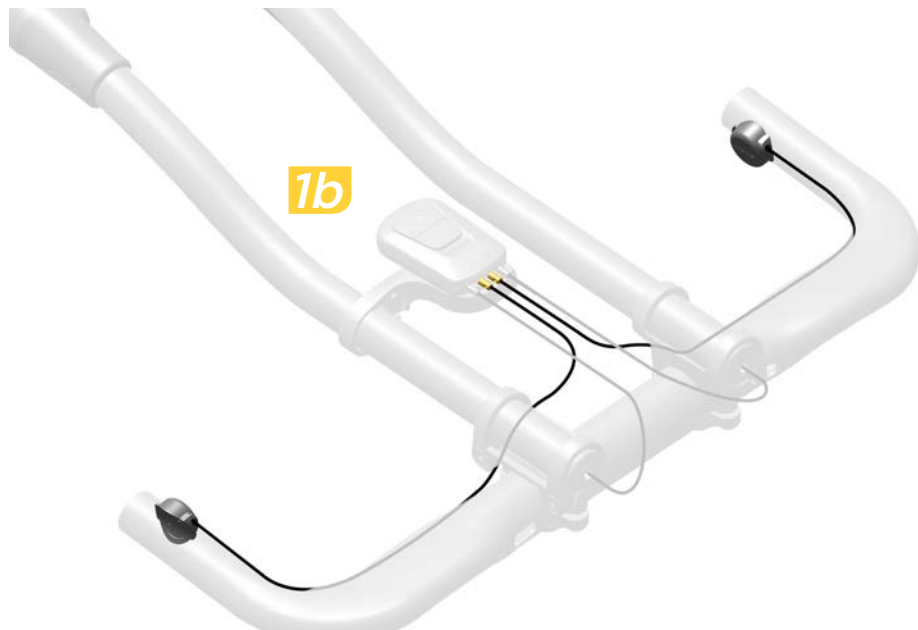

1b

Route each Blip wire, internally (1a) or externally (1b), on the handlebar and plug the connector into the BlipBox; left (-), right (+).

Route each Blip wire, internally (1a) or externally (1b), on the handlebar and plug the connector into the BlipBox; left (-), right (+).

Route each Blip wire, internally (1a) or externally (1b), on the handlebar and plug the connector into the BlipBox; left (-), right (+).

Route each Blip wire, internally (1a) or externally (1b), on the handlebar and plug the connector into the BlipBox; left (-), right (+).

Route each Blip wire, internally (1a) or externally (1b), on the handlebar and plug the connector into the BlipBox; left (-), right (+).

Route each Blip wire, internally (1a) or externally (1b), on the handlebar and plug the connector into the BlipBox; left (-), right (+).

Route each Blip wire, internally (1a) or externally (1b), on the handlebar and plug the connector into the BlipBox; left (-), right (+).

Route each Blip wire, internally (1a) or externally (1b), on the handlebar and plug the connector into the BlipBox; left (-), right (+).

Route each Blip wire, internally (1a) or externally (1b), on the handlebar and plug the connector into the BlipBox; left (-), right (+).



Install
Einbauen
Instalación

Installer
Installare
Monteren

Instalar
取り付け
安裝

Drop Bar

Drop Bar
Drop Bar

Drop Bar
Drop Bar
Drop Bar

Drop Bar
Drop Bar
Drop Bar

Option 1

Option 1
Option 1

Option 1
Option 1
Option 1

Option 1
Option 1
Option 1

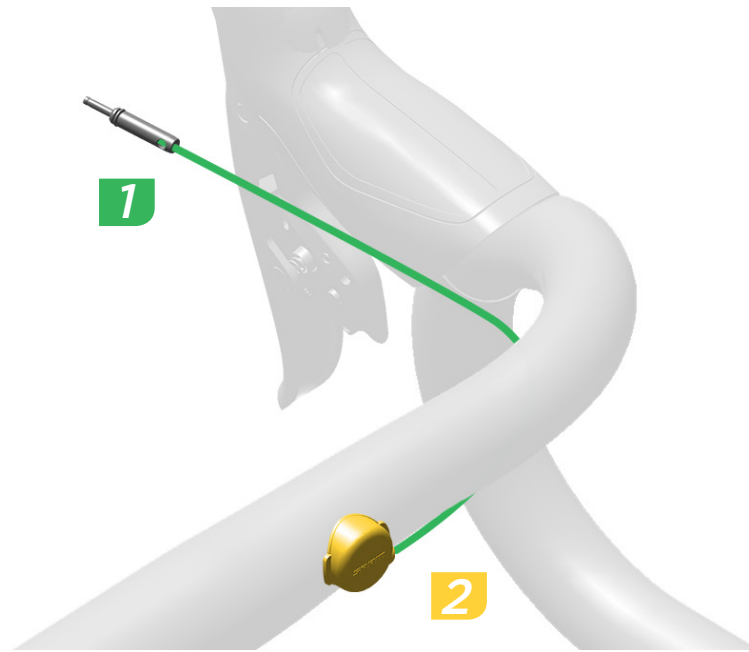

Clean the handlebar surface with isopropyl alcohol.

Attach the Blip to the handlebar with the adhesive tab in the desired ergonomic position.

Clean the handlebar surface with isopropyl alcohol.

Attach the Blip to the handlebar with the adhesive tab in the desired ergonomic position.

Clean the handlebar surface with isopropyl alcohol.

Attach the Blip to the handlebar with the adhesive tab in the desired ergonomic position.

Clean the handlebar surface with isopropyl alcohol.

Attach the Blip to the handlebar with the adhesive tab in the desired ergonomic position.

Clean the handlebar surface with isopropyl alcohol.

Attach the Blip to the handlebar with the adhesive tab in the desired ergonomic position.

Clean the handlebar surface with isopropyl alcohol.

Attach the Blip to the handlebar with the adhesive tab in the desired ergonomic position.

Clean the handlebar surface with isopropyl alcohol.

Attach the Blip to the handlebar with the adhesive tab in the desired ergonomic position.

Clean the handlebar surface with isopropyl alcohol.

Attach the Blip to the handlebar with the adhesive tab in the desired ergonomic position.

Clean the handlebar surface with isopropyl alcohol.

Attach the Blip to the handlebar with the adhesive tab in the desired ergonomic position.

Option 2

Option 2

Option 2

Option 2

Option 2

Option 2

Option 2

Option 2

Option 2

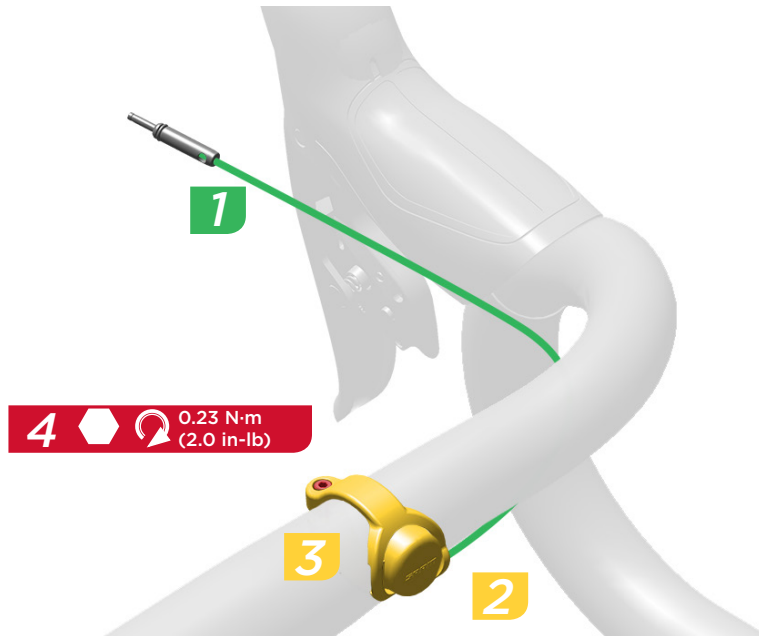

Insert the Blip into the clamp. Attach the clamp to the handlebar and rotate to the desired position. Tighten the clamp bolt.

Insert the Blip into the clamp. Attach the clamp to the handlebar and rotate to the desired position. Tighten the clamp bolt.

Insert the Blip into the clamp. Attach the clamp to the handlebar and rotate to the desired position. Tighten the clamp bolt.

Insert the Blip into the clamp. Attach the clamp to the handlebar and rotate to the desired position. Tighten the clamp bolt.

Insert the Blip into the clamp. Attach the clamp to the handlebar and rotate to the desired position. Tighten the clamp bolt.

Insert the Blip into the clamp. Attach the clamp to the handlebar and rotate to the desired position. Tighten the clamp bolt.

Insert the Blip into the clamp. Attach the clamp to the handlebar and rotate to the desired position. Tighten the clamp bolt.

Insert the Blip into the clamp. Attach the clamp to the handlebar and rotate to the desired position. Tighten the clamp bolt.

Insert the Blip into the clamp. Attach the clamp to the handlebar and rotate to the desired position. Tighten the clamp bolt.

Shifter

Shifter
Shifter
Shifter

Shifter
Shifter
Shifter

Shifter
Shifter
Shifter

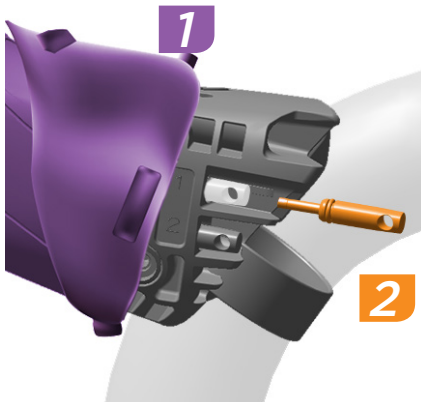

Fold the hood cover back and remove the dummy plug.

Fold the hood cover back and remove the dummy plug.

Fold the hood cover back and remove the dummy plug.

Fold the hood cover back and remove the dummy plug.

Fold the hood cover back and remove the dummy plug.

Fold the hood cover back and remove the dummy plug.

Fold the hood cover back and remove the dummy plug.

Fold the hood cover back and remove the dummy plug.

Fold the hood cover back and remove the dummy plug.

Plug the wire connector into the shifter.

Plug the wire connector into the shifter.

Plug the wire connector into the shifter.

Plug the wire connector into the shifter.

Plug the wire connector into the shifter.

Plug the wire connector into the shifter.

Plug the wire connector into the shifter.

Plug the wire connector into the shifter.

Plug the wire connector into the shifter.



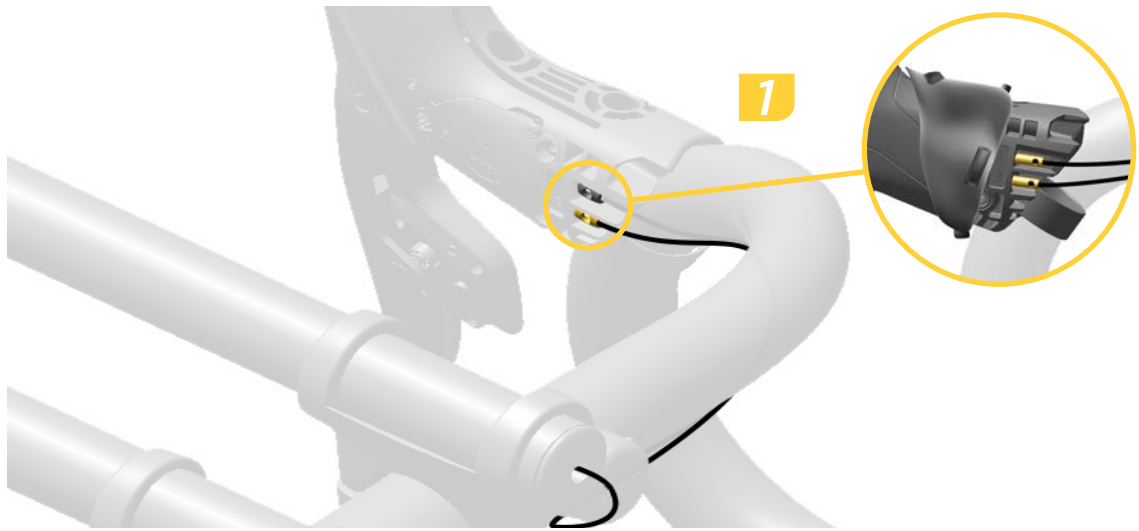

Refer to pages 16-18 for bar extension Blip installation.

Route the Blip wire from the bar extension under the drop handlebar and plug it into the eTap shifter input 2.

Refer to pages 16-18 for bar extension Blip installation.

Route the Blip wire from the bar extension under the drop handlebar and plug it into the shifter input 2.

Refer to pages 16-18 for bar extension Blip installation.

Route the Blip wire from the bar extension under the drop handlebar and plug it into the shifter input 2.

Refer to pages 16-18 for bar extension Blip installation.

Route the Blip wire from the bar extension under the drop handlebar and plug it into the shifter input 2.

Refer to pages 16-18 for bar extension Blip installation.

Route the Blip wire from the bar extension under the drop handlebar and plug it into the shifter input 2.

Refer to pages 16-18 for bar extension Blip installation.

Route the Blip wire from the bar extension under the drop handlebar and plug it into the shifter input 2.

Refer to pages 16-18 for bar extension Blip installation.

Route the Blip wire from the bar extension under the drop handlebar and plug it into the shifter input 2.

Refer to pages 16-18 for bar extension Blip installation.

Route the Blip wire from the bar extension under the drop handlebar and plug it into the shifter input 2.

Refer to pages 16-18 for bar extension Blip installation.

Route the Blip wire from the bar extension under the drop handlebar and plug it into the shifter input 2.



Fold the hood back onto the shifter.

NOTICE

Handlebar tape can be wrapped over the Blip button and wire.

Fold the hood back onto the shifter.

NOTICE

Handlebar tape can be wrapped over the Blip button and wire.

Fold the hood back onto the shifter.

NOTICE

Handlebar tape can be wrapped over the Blip button and wire.

Fold the hood back onto the shifter.

NOTICE

Handlebar tape can be wrapped over the Blip button and wire.

Fold the hood back onto the shifter.

NOTICE

Handlebar tape can be wrapped over the Blip button and wire.

Fold the hood back onto the shifter.

NOTICE

Handlebar tape can be wrapped over the Blip button and wire.

Fold the hood back onto the shifter.

NOTICE

Handlebar tape can be wrapped over the Blip button and wire.

Fold the hood back onto the shifter.

NOTICE

Handlebar tape can be wrapped over the Blip button and wire.

Fold the hood back onto the shifter.

NOTICE

Handlebar tape can be wrapped over the Blip button and wire.

Pairing

Pairing
Pairing
Pairing

Pairing
Pairing
Pairing

Pairing
Pairing
Pairing

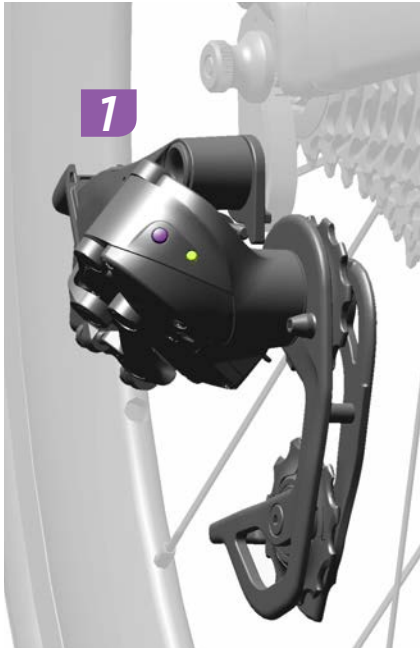

Begin the pairing session at the rear derailleur. Press and hold the function button on the rear derailleur until the green LED blinks slowly, then release.

Begin the pairing session at the rear derailleur. Press and hold the function button on the rear derailleur until the green LED blinks slowly, then release.

Begin the pairing session at the rear derailleur. Press and hold the function button on the rear derailleur until the green LED blinks slowly, then release.

Individually pair the other components in any order. Press and hold the function button on each component until its LED blinks quickly, then release.

Individually pair the other components in any order. Press and hold the function button on each component until its LED blinks quickly, then release.

Individually pair the other components in any order. Press and hold the function button on each component until its LED blinks quickly, then release.



Begin the pairing session at the rear derailleur. Press and hold the function button on the rear derailleur until the green LED blinks slowly, then release.

Begin the pairing session at the rear derailleur. Press and hold the function button on the rear derailleur until the green LED blinks slowly, then release.

Begin the pairing session at the rear derailleur. Press and hold the function button on the rear derailleur until the green LED blinks slowly, then release.

Individually pair the other components in any order. Press and hold the function button on each component until its LED blinks quickly, then release.

Individually pair the other components in any order. Press and hold the function button on each component until its LED blinks quickly, then release.

Individually pair the other components in any order. Press and hold the function button on each component until its LED blinks quickly, then release.



Begin the pairing session at the rear derailleur. Press and hold the function button on the rear derailleur until the green LED blinks slowly, then release.

Begin the pairing session at the rear derailleur. Press and hold the function button on the rear derailleur until the green LED blinks slowly, then release.

Begin the pairing session at the rear derailleur. Press and hold the function button on the rear derailleur until the green LED blinks slowly, then release.

Individually pair the other components in any order. Press and hold the function button on each component until its LED blinks quickly, then release.

Individually pair the other components in any order. Press and hold the function button on each component until its LED blinks quickly, then release.

Individually pair the other components in any order. Press and hold the function button on each component until its LED blinks quickly, then release.



Adjust
Einstellen
Ajustar

Régler
Regolare
Afstellen

Ajustar
調節
調節

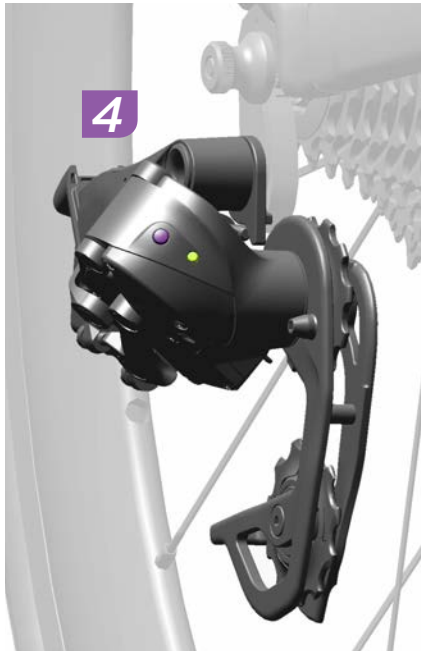

To end the pairing session, press and release the function button on the rear derailleur. Verify the system is paired by shifting the derailleurs in both directions.

To end the pairing session, press and release the function button on the rear derailleur. Verify the system is paired by shifting the derailleurs in both directions.

To end the pairing session, press and release the function button on the rear derailleur. Verify the system is paired by shifting the derailleurs in both directions.

To end the pairing session, press and release the function button on the rear derailleur. Verify the system is paired by shifting the derailleurs in both directions.

To end the pairing session, press and release the function button on the rear derailleur. Verify the system is paired by shifting the derailleurs in both directions.

To end the pairing session, press and release the function button on the rear derailleur. Verify the system is paired by shifting the derailleurs in both directions.

To end the pairing session, press and release the function button on the rear derailleur. Verify the system is paired by shifting the derailleurs in both directions.

To end the pairing session, press and release the function button on the rear derailleur. Verify the system is paired by shifting the derailleurs in both directions.

To end the pairing session, press and release the function button on the rear derailleur. Verify the system is paired by shifting the derailleurs in both directions.

Shifting

Shifting
Shifting

Shifting
Shifting
Shifting

Shifting
Shifting
Shifting

Rear Derailleur

Rear Derailleur
Rear Derailleur

Rear Derailleur
Rear Derailleur
Rear Derailleur

Rear Derailleur
Rear Derailleur
Rear Derailleur

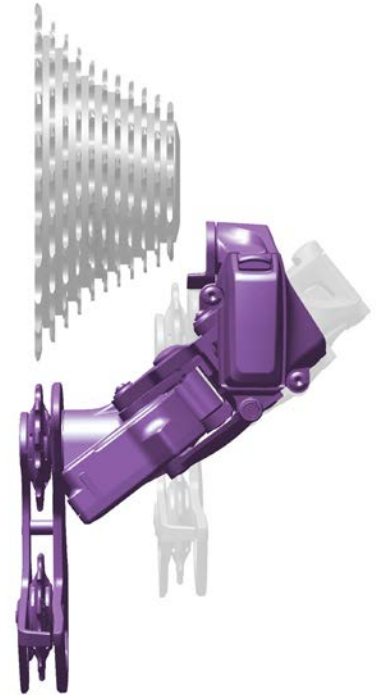



Press the left blip or the  on the BlipBox to move the rear derailleur inboard. Press and hold for multiple shifts.

Press the left blip or the  on the BlipBox to move the rear derailleur inboard. Press and hold for multiple shifts.

Press the left blip or the  on the BlipBox to move the rear derailleur inboard. Press and hold for multiple shifts.

Press the left blip or the  on the BlipBox to move the rear derailleur inboard. Press and hold for multiple shifts.

Press the left blip or the  on the BlipBox to move the rear derailleur inboard. Press and hold for multiple shifts.

Press the left blip or the  on the BlipBox to move the rear derailleur inboard. Press and hold for multiple shifts.

Press the left blip or the  on the BlipBox to move the rear derailleur inboard. Press and hold for multiple shifts.

Press the left blip or the  on the BlipBox to move the rear derailleur inboard. Press and hold for multiple shifts.

Press the left blip or the  on the BlipBox to move the rear derailleur inboard. Press and hold for multiple shifts.



Adjust
Einstellen
Ajustar

Régler
Regolare
Afstellen

Ajustar
調節
调节



Press the right blip or the **+** on the BlipBox to move the rear derailleur outboard. Press and hold for multiple shifts.

Press the right blip or the **+** on the BlipBox to move the rear derailleur outboard. Press and hold for multiple shifts.

Press the right blip or the **+** on the BlipBox to move the rear derailleur outboard. Press and hold for multiple shifts.

Press the right blip or the **+** on the BlipBox to move the rear derailleur outboard. Press and hold for multiple shifts.

Press the right blip or the **+** on the BlipBox to move the rear derailleur outboard. Press and hold for multiple shifts.

Press the right blip or the **+** on the BlipBox to move the rear derailleur outboard. Press and hold for multiple shifts.

Press the right blip or the **+** on the BlipBox to move the rear derailleur outboard. Press and hold for multiple shifts.

Press the right blip or the **+** on the BlipBox to move the rear derailleur outboard. Press and hold for multiple shifts.

Press the right blip or the **+** on the BlipBox to move the rear derailleur outboard. Press and hold for multiple shifts.



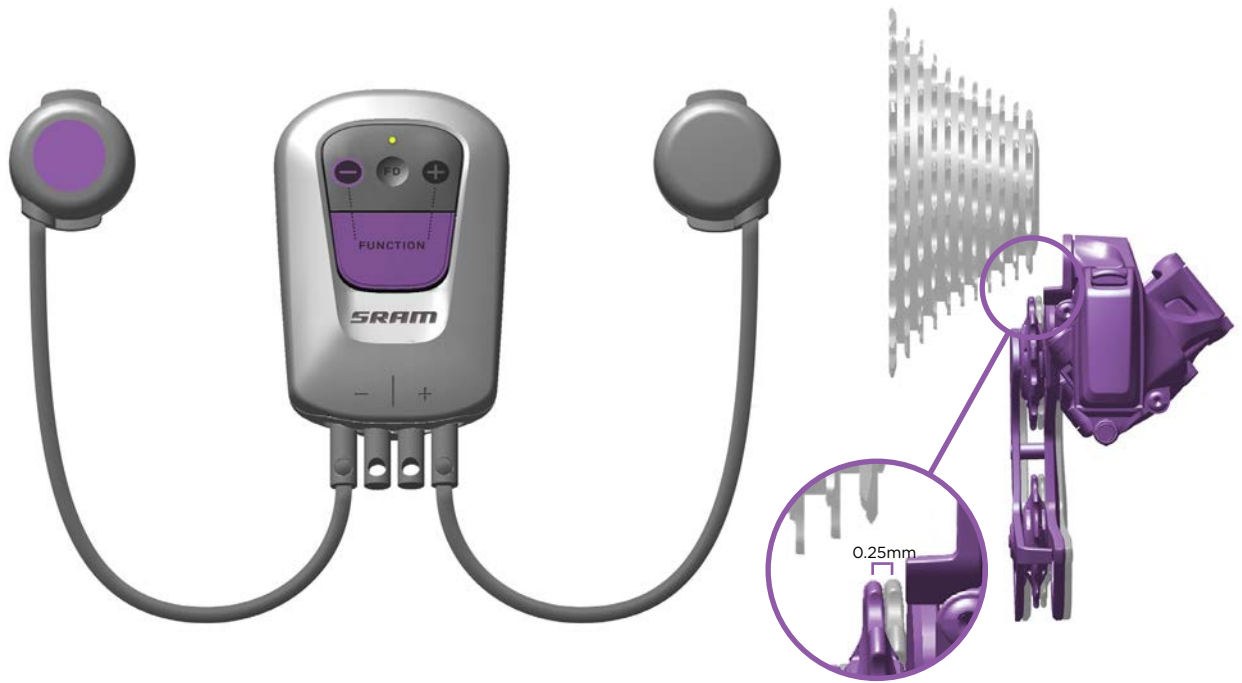



Rear derailleur micro adjustment can eliminate unwanted chain rub or noise. To micro adjust inboard, press and hold the FUNCTION button, then press the left blip or  button. Repeat until the adjustment is complete.

Rear derailleur micro adjustment can eliminate unwanted chain rub or noise. To micro adjust inboard, press and hold the FUNCTION button, then press the left blip or  button. Repeat until the adjustment is complete.

Rear derailleur micro adjustment can eliminate unwanted chain rub or noise. To micro adjust inboard, press and hold the FUNCTION button, then press the left blip or  button. Repeat until the adjustment is complete.

Rear derailleur micro adjustment can eliminate unwanted chain rub or noise. To micro adjust inboard, press and hold the FUNCTION button, then press the left blip or  button. Repeat until the adjustment is complete.

Rear derailleur micro adjustment can eliminate unwanted chain rub or noise. To micro adjust inboard, press and hold the FUNCTION button, then press the left blip or  button. Repeat until the adjustment is complete.

Rear derailleur micro adjustment can eliminate unwanted chain rub or noise. To micro adjust inboard, press and hold the FUNCTION button, then press the left blip or  button. Repeat until the adjustment is complete.

Rear derailleur micro adjustment can eliminate unwanted chain rub or noise. To micro adjust inboard, press and hold the FUNCTION button, then press the left blip or  button. Repeat until the adjustment is complete.

Rear derailleur micro adjustment can eliminate unwanted chain rub or noise. To micro adjust inboard, press and hold the FUNCTION button, then press the left blip or  button. Repeat until the adjustment is complete.

Rear derailleur micro adjustment can eliminate unwanted chain rub or noise. To micro adjust inboard, press and hold the FUNCTION button, then press the left blip or  button. Repeat until the adjustment is complete.



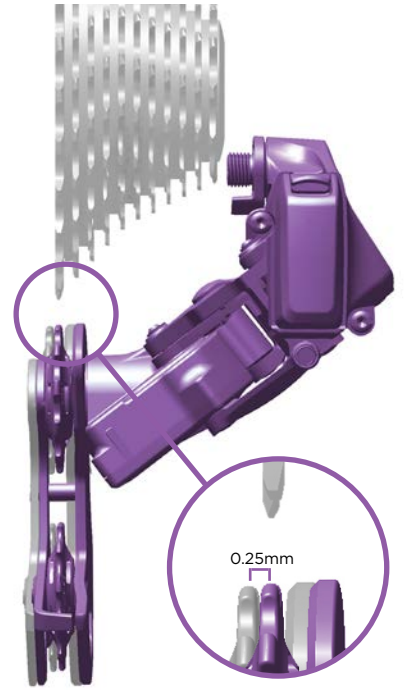

To micro adjust outboard, press and hold the FUNCTION button, then press the right blip or + button. Repeat until the adjustment is complete.

To micro adjust outboard, press and hold the FUNCTION button, then press the right blip or + button. Repeat until the adjustment is complete.

To micro adjust outboard, press and hold the FUNCTION button, then press the right blip or + button. Repeat until the adjustment is complete.

To micro adjust outboard, press and hold the FUNCTION button, then press the right blip or + button. Repeat until the adjustment is complete.

To micro adjust outboard, press and hold the FUNCTION button, then press the right blip or + button. Repeat until the adjustment is complete.

To micro adjust outboard, press and hold the FUNCTION button, then press the right blip or + button. Repeat until the adjustment is complete.

To micro adjust outboard, press and hold the FUNCTION button, then press the right blip or + button. Repeat until the adjustment is complete.

To micro adjust outboard, press and hold the FUNCTION button, then press the right blip or + button. Repeat until the adjustment is complete.

To micro adjust outboard, press and hold the FUNCTION button, then press the right blip or + button. Repeat until the adjustment is complete.



Front Derailleur

Front Derailleur
Front Derailleur

Front Derailleur
Front Derailleur
Front Derailleur

Front Derailleur
Front Derailleur
Front Derailleur





Press both Blips simultaneously, or press  on the Blip Box, to move the front derailleur inboard or outboard.

Press both Blips simultaneously, or press  on the Blip Box, to move the front derailleur inboard or outboard.

Press both Blips simultaneously, or press  on the Blip Box, to move the front derailleur inboard or outboard.

Press both Blips simultaneously, or press  on the Blip Box, to move the front derailleur inboard or outboard.

Press both Blips simultaneously, or press  on the Blip Box, to move the front derailleur inboard or outboard.

Press both Blips simultaneously, or press  on the Blip Box, to move the front derailleur inboard or outboard.

Press both Blips simultaneously, or press  on the Blip Box, to move the front derailleur inboard or outboard.

Press both Blips simultaneously, or press  on the Blip Box, to move the front derailleur inboard or outboard.

Press both Blips simultaneously, or press  on the Blip Box, to move the front derailleur inboard or outboard.



Adjust
Einstellen
Ajustar

Régler
Regolare
Afstellen

Ajustar
調節
调节

Battery

Battery
Battery







Battery

Battery
Battery

Battery

Battery
Battery



		12-3 months 12-3 Monate 12-3 meses	24 à 6 mois 12-3 mesi 12-3 maanden	12-3 meses 12~3 か月 12-3 月
		3-1 months 3-1 Monate 3-1 mes	6 à 1 mois 3-1 mesi 3-1 maanden	3-1 meses 3~1 か月 3-1 月
		< 1 month < 1 Monat < 1 mes	< 1 mois < 1 mese < 1 maand	< 1 mês < 1 か月 < 1 月

The LED lights up when a shift is performed. The color of the LED indicates the ride time remaining.

Die LED leuchtet auf, wenn ein Schaltvorgang durchgeführt wird. Die Farbe der LED gibt die verbleibende Fahrzeit an.

El LED se enciende cada vez que se realiza un cambio de marcha. El color del LED indica el tiempo de marcha restante.

Les LED s'allument à chaque fois que vous passez une vitesse. La couleur de la LED indique la durée d'autonomie restante.

Il LED si illumina durante un cambio. Il colore del LED indica il tempo di guida rimanente.

De LED brandt wanneer wordt geschakeld. De kleur van de LED geeft de resterende fietstijd aan.

O LED acende quando se mete uma mudança. A cor do LED indica o tempo de ciclismo que lhe resta.

シフトを行うとLEDが点灯します。LEDの色は、残りの乗車可能時間を示しています。

变速时，LED会亮起。LED的颜色表示剩余的骑行时间。

Replacement

Replacement
Replacement



1



2

Insert a new CR2032 coin cell battery into the battery cap, terminal side out.

Insert a new CR2032 coin cell battery into the battery cap, terminal side out.

Insert a new CR2032 coin cell battery into the battery cap, terminal side out.

Insert a new CR2032 coin cell battery into the battery cap, terminal side out.

Insert a new CR2032 coin cell battery into the battery cap, terminal side out.

Insert a new CR2032 coin cell battery into the battery cap, terminal side out.

Insert a new CR2032 coin cell battery into the battery cap, terminal side out.

Insert a new CR2032 coin cell battery into the battery cap, terminal side out.

Insert a new CR2032 coin cell battery into the battery cap, terminal side out.



3

Replacement
Replacement
Replacement

Use a coin to remove the battery cap. Remove the old battery.

NOTICE

Do not remove the battery cap o-ring seal.

Use a coin to remove the battery cap. Remove the old battery.

NOTICE

Do not remove the battery cap o-ring seal.

Replacement
Replacement
Replacement

Use a coin to remove the battery cap. Remove the old battery.

NOTICE

Do not remove the battery cap o-ring seal.

Use a coin to remove the battery cap. Remove the old battery.

NOTICE

Do not remove the battery cap o-ring seal.

Use a coin to remove the battery cap. Remove the old battery.

NOTICE

Do not remove the battery cap o-ring seal.

Use a coin to remove the battery cap. Remove the old battery.

NOTICE

Do not remove the battery cap o-ring seal.



Remove
Entfernen
Quitar

Retirar
Rimuovere
Verwijderen

Retirar
取り外し
拆卸



Install
Einbauen
Instalación

Installer
Installare
Monteren

Instalar
取り付け
安裝



Reinstall the battery cap.
Use a coin and turn the cap clockwise to lock it into place.

Reinstall the battery cap.
Use a coin and turn the cap clockwise to lock it into place.

Reinstall the battery cap.
Use a coin and turn the cap clockwise to lock it into place.

Reinstall the battery cap.
Use a coin and turn the cap clockwise to lock it into place.

Reinstall the battery cap.
Use a coin and turn the cap clockwise to lock it into place.

Reinstall the battery cap.
Use a coin and turn the cap clockwise to lock it into place.

Reinstall the battery cap.
Use a coin and turn the cap clockwise to lock it into place.

Reinstall the battery cap.
Use a coin and turn the cap clockwise to lock it into place.

Reinstall the battery cap.
Use a coin and turn the cap clockwise to lock it into place.

⚠WARNING

Do not use sharp objects to remove batteries.
Keep battery out of reach of children.
Do not put the battery in your mouth. If ingested, seek medical attention immediately.
Do not disassemble, damage, or puncture the battery.
Consult the battery manufacturer for safe handling instructions.

⚠WARNING

Do not use sharp objects to remove batteries.
Keep battery out of reach of children.
Do not put the battery in your mouth. If ingested, seek medical attention immediately.
Do not disassemble, damage, or puncture the battery.
Consult the battery manufacturer for safe handling instructions.

⚠WARNING

Do not use sharp objects to remove batteries.
Keep battery out of reach of children.
Do not put the battery in your mouth. If ingested, seek medical attention immediately.
Do not disassemble, damage, or puncture the battery.
Consult the battery manufacturer for safe handling instructions.

⚠WARNING

Do not use sharp objects to remove batteries.
Keep battery out of reach of children.
Do not put the battery in your mouth. If ingested, seek medical attention immediately.
Do not disassemble, damage, or puncture the battery.
Consult the battery manufacturer for safe handling instructions.

⚠WARNING

Do not use sharp objects to remove batteries.
Keep battery out of reach of children.
Do not put the battery in your mouth. If ingested, seek medical attention immediately.
Do not disassemble, damage, or puncture the battery.
Consult the battery manufacturer for safe handling instructions.

⚠WARNING

Do not use sharp objects to remove batteries.
Keep battery out of reach of children.
Do not put the battery in your mouth. If ingested, seek medical attention immediately.
Do not disassemble, damage, or puncture the battery.
Consult the battery manufacturer for safe handling instructions.

⚠WARNING

Do not use sharp objects to remove batteries.
Keep battery out of reach of children.
Do not put the battery in your mouth. If ingested, seek medical attention immediately.
Do not disassemble, damage, or puncture the battery.
Consult the battery manufacturer for safe handling instructions.

⚠WARNING

Do not use sharp objects to remove batteries.
Keep battery out of reach of children.
Do not put the battery in your mouth. If ingested, seek medical attention immediately.
Do not disassemble, damage, or puncture the battery.
Consult the battery manufacturer for safe handling instructions.

⚠WARNING

Do not use sharp objects to remove batteries.
Keep battery out of reach of children.
Do not put the battery in your mouth. If ingested, seek medical attention immediately.
Do not disassemble, damage, or puncture the battery.
Consult the battery manufacturer for safe handling instructions.



Install
Einbauen
Instalación

Installer
Installare
Monteren

Instalar
取り付け
安裝



Adjust
Einstellen
Ajustar

Régler
Regolare
Afstellen

Ajustar
調節
調節

Periodic cleaning is recommended.

Use a damp cloth to wipe the components until clean.

Periodically inspect each Blip connector wire for damage. Replace the Blip if the wire is damaged.

Periodic cleaning is recommended.

Use a damp cloth to wipe the components until clean.

Periodically inspect each Blip connector wire for damage. Replace the Blip if the wire is damaged.

Periodic cleaning is recommended.

Use a damp cloth to wipe the components until clean.

Periodically inspect each Blip connector wire for damage. Replace the Blip if the wire is damaged.

Periodic cleaning is recommended.

Use a damp cloth to wipe the components until clean.

Periodically inspect each Blip connector wire for damage. Replace the Blip if the wire is damaged.

Periodic cleaning is recommended.

Use a damp cloth to wipe the components until clean.

Periodically inspect each Blip connector wire for damage. Replace the Blip if the wire is damaged.

Periodic cleaning is recommended.

Use a damp cloth to wipe the components until clean.

Periodically inspect each Blip connector wire for damage. Replace the Blip if the wire is damaged.

Periodic cleaning is recommended.

Use a damp cloth to wipe the components until clean.

Periodically inspect each Blip connector wire for damage. Replace the Blip if the wire is damaged.

Periodic cleaning is recommended.

Use a damp cloth to wipe the components until clean.

Periodically inspect each Blip connector wire for damage. Replace the Blip if the wire is damaged.

Periodic cleaning is recommended.

Use a damp cloth to wipe the components until clean.

Periodically inspect each Blip connector wire for damage. Replace the Blip if the wire is damaged.

▲WARNING

Do not use or clean the BlipBox or eTap™ shifters without connector wires or dummy plugs installed. Moisture will damage the electronics.

Avoid using or storing the device in excessive heat or cold.

Avoid chemical cleaners and solvents that can damage plastic components.

Do not submerge the BlipBox in liquid of any kind.

Do not clean the BlipBox with a power washer.

▲WARNING

Do not use or clean the BlipBox or eTap™ shifters without connector wires or dummy plugs installed. Moisture will damage the electronics.

Avoid using or storing the device in excessive heat or cold.

Avoid chemical cleaners and solvents that can damage plastic components.

Do not submerge the BlipBox in liquid of any kind.

Do not clean the BlipBox with a power washer.

▲WARNING

Do not use or clean the BlipBox or eTap™ shifters without connector wires or dummy plugs installed. Moisture will damage the electronics.

Avoid using or storing the device in excessive heat or cold.

Avoid chemical cleaners and solvents that can damage plastic components.

Do not submerge the BlipBox in liquid of any kind.

Do not clean the BlipBox with a power washer.

▲WARNING

Do not use or clean the BlipBox or eTap™ shifters without connector wires or dummy plugs installed. Moisture will damage the electronics.

Avoid using or storing the device in excessive heat or cold.

Avoid chemical cleaners and solvents that can damage plastic components.

Do not submerge the BlipBox in liquid of any kind.

Do not clean the BlipBox with a power washer.

▲WARNING

Do not use or clean the BlipBox or eTap™ shifters without connector wires or dummy plugs installed. Moisture will damage the electronics.

Avoid using or storing the device in excessive heat or cold.

Avoid chemical cleaners and solvents that can damage plastic components.

Do not submerge the BlipBox in liquid of any kind.

Do not clean the BlipBox with a power washer.

▲WARNING

Do not use or clean the BlipBox or eTap™ shifters without connector wires or dummy plugs installed. Moisture will damage the electronics.

Avoid using or storing the device in excessive heat or cold.

Avoid chemical cleaners and solvents that can damage plastic components.

Do not submerge the BlipBox in liquid of any kind.

Do not clean the BlipBox with a power washer.

▲WARNING

Do not use or clean the BlipBox or eTap™ shifters without connector wires or dummy plugs installed. Moisture will damage the electronics.

Avoid using or storing the device in excessive heat or cold.

Avoid chemical cleaners and solvents that can damage plastic components.

Do not submerge the BlipBox in liquid of any kind.

Do not clean the BlipBox with a power washer.

▲WARNING

Do not use or clean the BlipBox or eTap™ shifters without connector wires or dummy plugs installed. Moisture will damage the electronics.

Avoid using or storing the device in excessive heat or cold.

Avoid chemical cleaners and solvents that can damage plastic components.

Do not submerge the BlipBox in liquid of any kind.

Do not clean the BlipBox with a power washer.

▲WARNING

Do not use or clean the BlipBox or eTap™ shifters without connector wires or dummy plugs installed. Moisture will damage the electronics.

Avoid using or storing the device in excessive heat or cold.

Avoid chemical cleaners and solvents that can damage plastic components.

Do not submerge the BlipBox in liquid of any kind.

Do not clean the BlipBox with a power washer.

For consumers in the United States and Canada, SRAM has partnered with the Rechargeable Battery Recycling Corporation. Please call 1-800-8-BATTERY or visit www.rbrc.org for additional information.

Replace the battery with an authentic SRAM replacement battery only.

Used batteries must be recycled in accordance with local and federal government regulations.

▲WARNING

Do not place batteries in a fire.

For consumers in the United States and Canada, SRAM has partnered with the Rechargeable Battery Recycling Corporation. Please call 1-800-8-BATTERY or visit www.rbrc.org for additional information.

Replace the battery with an authentic SRAM replacement battery only.

Used batteries must be recycled in accordance with local and federal government regulations.

▲WARNING

Do not throw batteries in a fire.

For consumers in the United States and Canada, SRAM has partnered with the Rechargeable Battery Recycling Corporation. Please call 1-800-8-BATTERY or visit www.rbrc.org for additional information.

Replace the battery with an authentic SRAM replacement battery only.

Used batteries must be recycled in accordance with local and federal government regulations.

▲WARNING

Do not place batteries in a fire.

For consumers in the United States and Canada, SRAM has partnered with the Rechargeable Battery Recycling Corporation. Please call 1-800-8-BATTERY or visit www.rbrc.org for additional information.

Replace the battery with an authentic SRAM replacement battery only.

Used batteries must be recycled in accordance with local and federal government regulations.

▲WARNING

Do not place batteries in a fire.

For consumers in the United States and Canada, SRAM has partnered with the Rechargeable Battery Recycling Corporation. Please call 1-800-8-BATTERY or visit www.rbrc.org for additional information.

Replace the battery with an authentic SRAM replacement battery only.

Used batteries must be recycled in accordance with local and federal government regulations.

▲WARNING

Do not throw batteries in a fire.

For consumers in the United States and Canada, SRAM has partnered with the Rechargeable Battery Recycling Corporation. Please call 1-800-8-BATTERY or visit www.rbrc.org for additional information.

Replace the battery with an authentic SRAM replacement battery only.

Used batteries must be recycled in accordance with local and federal government regulations.

▲WARNING

Do not place batteries in a fire.

For consumers in the United States and Canada, SRAM has partnered with the Rechargeable Battery Recycling Corporation. Please call 1-800-8-BATTERY or visit www.rbrc.org for additional information.

Replace the battery with an authentic SRAM replacement battery only.

Used batteries must be recycled in accordance with local and federal government regulations.

▲WARNING

Do not place batteries in a fire.

For consumers in the United States and Canada, SRAM has partnered with the Rechargeable Battery Recycling Corporation. Please call 1-800-8-BATTERY or visit www.rbrc.org for additional information.

Replace the battery with an authentic SRAM replacement battery only.

Used batteries must be recycled in accordance with local and federal government regulations.

▲WARNING

Do not place batteries in a fire.

For consumers in the United States and Canada, SRAM has partnered with the Rechargeable Battery Recycling Corporation. Please call 1-800-8-BATTERY or visit www.rbrc.org for additional information.

Replace the battery with an authentic SRAM replacement battery only.

Used batteries must be recycled in accordance with local and federal government regulations.

▲WARNING

Do not place batteries in a fire.

Compliance
Compliance
Compliance

Compliance
Compliance
Compliance

Compliance
Compliance
Compliance

SRAM LLC certifies that this product and its packaging are in compliance with:

R&TTE Directive, the Radio and Telecommunication Terminal Equipment Directive 1999/5/EC

WEEE Directive, the Waste Electrical and Electronic Equipment Directive 2012/19/EU

RoHS Directive, the restriction of the use of certain hazardous substances in electrical and electronic equipment 2002/95/EC

REACH Directive, the Regulation on Registration, Evaluation, Authorization and Restriction of Chemical Directive 1907/2006/EC

Batteries and Accumulators and Waste Batteries and Accumulators Directive 2006/66/EU

This device complies with Part 15 of the FCC Rules. Operation is subject to the following two conditions: (1) this device may not cause harmful interference, and (2) this device must accept any interference received, including interference that may cause undesired operation.

Note: This equipment has been tested and found to comply with the limits for a Class B digital device, pursuant to part 15 of the FCC Rules. These limits are designed to provide reasonable protection against harmful interference in a residential installation. This equipment generates, uses and can radiate radio frequency energy and, if not installed and used in accordance with the instructions, may cause harmful interference to radio communications. However, there is no guarantee that interference will not occur in a particular installation. If this equipment does cause harmful interference to radio or television reception, which can be determined by turning the equipment off and on, the user is encouraged to try to correct the interference by one or more of the following measures:

- Reorient or relocate the receiving antenna.
- Increase the separation between the equipment and receiver.
- Connect the equipment into an outlet on a circuit different from that to which the receiver is connected.
- Consult the dealer or an experienced radio/TV technician for help.

This device complies with Industry Canada's license-exempt RSS standard(s). Operation is subject to the following two conditions: (1) this device may not cause interference, and (2) this device must accept any interference, including interference that may cause undesired operation of the device.

The term "IC:" before the radio certification number only signifies that Industry Canada technical specifications were met. Canadian Department of Communications Compliance Statement:

Firmware Update Dongle - DOC: CAN ICES-3(B)/NMB-3(B) C

Le présent appareil est conforme aux CNR d'Industrie Canada applicables aux appareils radio exempts de licence.

L'exploitation est autorisée aux deux conditions suivantes : (1) l'appareil ne doit pas produire de brouillage, et (2) l'utilisateur de l'appareil doit accepter tout brouillage radioélectrique subi, même si le brouillage est susceptible d'en compromettre le fonctionnement.

Warning: Any changes or modifications not expressly approved by SRAM could void the user's authority to operate this equipment.

This product is ANT+ certified and complies with the bicycle power ANT+ Device Profile. For a complete listing of ANT+ Certified Products and their specific interoperability, please visit www.thisisant.com.

SRAM LLC WORLD HEADQUARTERS

1000 W. Fulton Market, 4th Floor

Chicago, Illinois 60607

USA

Left Shifter
Model#:00001
FCC ID: C9O-LSBED
IC: 10161A-LSBED

Right Shifter
Model#:00101
FCC ID: C9O-RSBED
IC: 10161A-RSBED

BlipBox
Model#:00201
FCC ID: C9O-BOXED
IC: 10161A-BOXED

Firmware Update Dongle
Model#:12701
FCC ID: C9O-LINKED
IC: 10161A-LINKED

Front Derailleur
Model#:12801
FCC ID: C9O-FDED
IC: 10161A-FDED

Rear Derailleur
Model#:12901
FCC ID: C9O-RDED
IC: 10161A-RDED

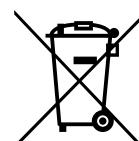

Rechargeable Lithium-ion Polymer Battery Model: 25401

Cell Type	300mAh/3.7V
Pack Configuration	2S1P
Nominal Voltage	7.4 DC
EOD Voltage	6.0V DC
Nominal Capacity	300mAh
Minimum Capacity	290mAh
(at 0.2C discharge rate 3.0v cut off after standard charge)	
Average Working Voltage	7.4V at 0.2C rate
Fast Charge	Constant current 1.0C
Constant Voltage	8.4V
Operating Temperature Range	
Standard Charge	32° to 114°F / 0° to 45°C
Discharge	-4° to 140°F / -20° to 60°C
Weight of Battery Approx	6.5 g
Cell Dimension	
Length	Max.30.0mm
Width	Max. 19.0mm
Thickness Max.	Thickness: Max. 6.0mm
Storage at 50% SOC and specified temp, recoverable capacities in % vs. time.	
-20° to 25°C (12 months, 85%)	25° to 45°C (3 months, 80%)
60° to 70°C (1 hour, 85%)	70° to 85°C (1 hour, 80%)

Battery Charger Model: 25301

The charger is designed to meet EMI safety standards for use in information technology equipment.

Rated Input Voltage	5V DC
Maximum Rated Output Voltage	8.4V
Operating Temperature Range	32°F to 104°F / 0°C to 40°C
Non-operating Temperature Range	50° to 140°F / 10°C to 60°
Relative Humidity for Operating and Non-operating	10% to 80%

Replacable Lithium Coin Cell Battery CR2032

Consult the battery manufacturer's instructions for technical information.

SRAM[®]

www.sram.com

“We will revolutionize the relationship that our users have with SRAM products, cultivating a bond between the rider and bicycle. Our technical communication will be delivered in innovative and exciting ways, with deliberation and accuracy that inspires loyalty and trust across the globe.”

-SRAM TechCom Vision Statement



ASIAN HEADQUARTERS
SRAM Taiwan
No. 1598-8 Chung Shan Road
Shen Kang Hsiang, Taichung City
Taiwan R.O.C.

WORLD HEADQUARTERS
SRAM LLC
1000 W. Fulton Market, 4th Floor
Chicago, Illinois 60607
USA

EUROPEAN HEADQUARTERS
SRAM Europe
Paasbosweg 14-16
3862ZS Nijkerk
The Netherlands