

FCC Test Report

Report No.: RFBHQC-WTW-P20110715

FCC ID: 2AYDXSCMAA1

Test Model: SCMAA1

Series Model: SCMBA1

Received Date: Nov. 24, 2020

Test Date: Nov. 30 ~ Dec. 22, 2020

Issued Date: Jan. 05, 2021

Applicant: Merlyn Mind, Inc.

Address: 405 Lexington Avenue, Suite 3504, New York, NY 10174, USA

Issued By: Bureau Veritas Consumer Products Services (H.K.) Ltd., Taoyuan Branch
Lin Kou Laboratories

Lab Address: No. 47-2, 14th Ling, Chia Pau Vil., Lin Kou Dist., New Taipei City, Taiwan

Test Location (1): No. 47-2, 14th Ling, Chia Pau Vil., Lin Kou Dist., New Taipei City, Taiwan

Test Location(2): No. 19, Hwa Ya 2nd Rd., Wen Hwa Vil., Kwei Shan Dist., Taoyuan City
33383, Taiwan

**FCC Registration /
Designation Number (1):** 198487 / TW2021

**FCC Registration /
Designation Number (2):** 788550 / TW0003



This report is for your exclusive use. Any copying or replication of this report to or for any other person or entity, or use of our name or trademark, is permitted only with our prior written permission. This report sets forth our findings solely with respect to the test samples identified herein. The results set forth in this report are not indicative or representative of the quality or characteristics of the lot from which a test sample was taken or any similar or identical product specifically and expressly noted. Our report includes all of the tests requested by you and the results thereof based upon the information that you provided to us. You have 60 days from date of issuance of this report to notify us of any material error or omission caused by our negligence, provided, however, that such notice shall be in writing and shall specifically address the issue you wish to raise. A failure to raise such issue within the prescribed time shall constitute your unqualified acceptance of the completeness of this report, the tests conducted and the correctness of the report contents. Unless specific mention, the uncertainty of measurement has been explicitly taken into account to declare the compliance or non-compliance to the specification.

Table of Contents

Release Control Record	4
1 Certificate of Conformity	5
2 Summary of Test Results	6
2.1 Measurement Uncertainty.....	6
2.2 Modification Record.....	6
3 General Information	7
3.1 General Description of EUT.....	7
3.2 Description of Test Modes.....	9
3.2.1 Test Mode Applicability and Tested Channel Detail.....	11
3.3 Duty Cycle of Test Signal.....	13
3.4 Description of Support Units.....	14
3.4.1 Configuration of System under Test.....	15
3.5 General Description of Applied Standards and References.....	16
4 Test Types and Results	17
4.1 Radiated Emission and Bandedge Measurement.....	17
4.1.1 Limits of Radiated Emission and Bandedge Measurement.....	17
4.1.2 Test Instruments.....	18
4.1.3 Test Procedures.....	19
4.1.4 Deviation from Test Standard.....	19
4.1.5 Test Setup.....	20
4.1.6 EUT Operating Conditions.....	21
4.1.7 Test Results.....	22
4.2 Conducted Emission Measurement.....	66
4.2.1 Limits of Conducted Emission Measurement.....	66
4.2.2 Test Instruments.....	66
4.2.3 Test Procedures.....	67
4.2.4 Deviation from Test Standard.....	67
4.2.5 Test Setup.....	67
4.2.6 EUT Operating Conditions.....	67
4.2.7 Test Results.....	68
4.3 Transmit Power Measurement.....	70
4.3.1 Limits of Transmit Power Measurement.....	70
4.3.2 Test Setup.....	70
4.3.3 Test Instruments.....	70
4.3.4 Test Procedure.....	71
4.3.5 Deviation from Test Standard.....	71
4.3.6 EUT Operating Conditions.....	71
4.3.7 Test Result.....	72
4.4 Occupied Bandwidth Measurement.....	83
4.4.1 Test Setup.....	83
4.4.2 Test Instruments.....	83
4.4.3 Test Procedure.....	83
4.4.4 Test Result.....	84
4.5 Peak Power Spectral Density Measurement.....	90
4.5.1 Limits of Peak Power Spectral Density Measurement.....	90
4.5.2 Test Setup.....	90
4.5.3 Test Instruments.....	90
4.5.4 Test Procedures.....	90
4.5.5 Deviation from Test Standard.....	91
4.5.6 EUT Operating Conditions.....	91
4.5.7 Test Results.....	92
4.6 Frequency Stability.....	98
4.6.1 Limits of Frequency Stability Measurement.....	98

4.6.2	Test Setup.....	98
4.6.3	Test Instruments	98
4.6.4	Test Procedure	98
4.6.5	Deviation from Test Standard	99
4.6.6	EUT Operating Condition	99
4.6.7	Test Results	99
4.7	6dB Bandwidth Measurement.....	100
4.7.1	Limits of 6dB Bandwidth Measurement.....	100
4.7.2	Test Setup.....	100
4.7.3	Test Instruments	100
4.7.4	Test Procedure	100
4.7.5	Deviation from Test Standard	100
4.7.6	EUT Operating Condition	100
4.7.7	Test Results	101
5	Pictures of Test Arrangements.....	103
	Annex A- Radiated out of Band Emission (OOBE) Measurement (For U-NII-3 band).....	104
	Annex B- Band Edge Measurement.....	107
	Appendix – Information of the Testing Laboratories	119

Release Control Record

Issue No.	Description	Date Issued
RFBHQC-WTW-P20110715	Original release	Jan. 05, 2021

1 Certificate of Conformity

Product: Symphony Classroom AI Enabled Classroom Hub

Brand: Symphony Classroom™

Test Model: SCMAA1

Series Model: SCMBA1

Sample Status: Engineering Sample

Applicant: Merlyn Mind, Inc.

Test Date: Nov. 30 ~ Dec. 22, 2020

Standards: 47 CFR FCC Part 15, Subpart E (Section 15.407)
ANSI C63.10:2013

The above equipment has been tested by **Bureau Veritas Consumer Products Services (H.K.) Ltd., Taoyuan Branch**, and found compliance with the requirement of the above standards. The test record, data evaluation & Equipment Under Test (EUT) configurations represented herein are true and accurate accounts of the measurements of the sample's RF characteristics under the conditions specified in this report.

Prepared by : Pettie Chen , **Date:** Jan. 05, 2021
Pettie Chen / Senior Specialist

Approved by : Bruce Chen , **Date:** Jan. 05, 2021
Bruce Chen / Senior Project Engineer

2 Summary of Test Results

47 CFR FCC Part 15, Subpart E (Section 15.407)			
FCC Clause	Test Item	Result	Remarks
15.407(b)(6)	AC Power Conducted Emissions	Pass	Meet the requirement of limit. Minimum passing margin is -12.90dB at 0.42344MHz.
15.407(b)(1/2/3/4(i/ii)/6)	Radiated Emissions & Band Edge Measurement	Pass	Meet the requirement of limit. Minimum passing margin is -0.1dB at 5350.00MHz.
15.407(a)(1/2/3)	Max Average Transmit Power	Pass	Meet the requirement of limit.
---	Occupied Bandwidth Measurement	-	Reference only.
15.407(a)(1/2/3)	Peak Power Spectral Density	Pass	Meet the requirement of limit.
15.407(e)	6dB bandwidth	Pass	Meet the requirement of limit. (U-NII-3 Band only)
15.407(g)	Frequency Stability	Pass	Meet the requirement of limit.
15.203	Antenna Requirement	Pass	Antenna connector is i-pex(MHF) not a standard connector.

Note:

- Determining compliance based on the results of the compliance measurement, not taking into account measurement instrumentation uncertainty.
- For U-NII-1, U-NII-2a, U-NII-2c band compliance with rule 15.407(b) of the band-edge items, the test plots were recorded in Annex B. Test Procedures refer to report 4.1.3.
For U-NII-3 band compliance with rule part 15.407(b)(4)(i), the OOB test plots were recorded in Annex A.

2.1 Measurement Uncertainty

Where relevant, the following measurement uncertainty levels have been estimated for tests performed on the EUT as specified in CISPR 16-4-2:

Measurement	Frequency	Expanded Uncertainty (k=2) (\pm)
Conducted Emissions at mains ports	150kHz ~ 30MHz	3.00 dB
Radiated Emissions up to 1 GHz	9kHz ~ 30MHz	3.04 dB
	30MHz ~ 200MHz	3.59 dB
	200MHz ~ 1000MHz	3.60 dB
Radiated Emissions above 1 GHz	1GHz ~ 18GHz	2.29 dB
	18GHz ~ 40GHz	2.29 dB

2.2 Modification Record

There were no modifications required for compliance.

3 General Information

3.1 General Description of EUT

Product	Symphony Classroom AI Enabled Classroom Hub
Brand	Symphony Classroom™
Test Model	SCMAA1
Series Model	SCMBA1
Model Difference	For marketing purpose
Sample Status	Engineering Sample
Power Supply Rating	19Vdc (Adapter)
Modulation Type	256QAM, 64QAM, 16QAM, QPSK, BPSK
Modulation Technology	OFDM
Transfer Rate	802.11a: 54/48/36/24/18/12/9/6Mbps 802.11n: up to 300Mbps 802.11ac: up to 866.7Mbps
Operating Frequency	5180 ~ 5240MHz, 5260 ~ 5320MHz, 5500 ~ 5720MHz, 5745 ~ 5825MHz
Number of Channel	5180 ~ 5240MHz: 802.11a, 802.11n (HT20), 802.11ac (VHT20): 4 802.11n (HT40), 802.11ac (VHT40): 2 802.11ac (VHT80): 1 5260 ~ 5320MHz: 802.11a, 802.11n (HT20), 802.11ac (VHT20): 4 802.11n (HT40), 802.11ac (VHT40): 2 802.11ac (VHT80): 1 5500 ~ 5720MHz: 802.11a, 802.11n (HT20), 802.11ac (VHT20): 12 802.11n (HT40), 802.11ac (VHT40): 6 802.11ac (VHT80): 3 5745 ~ 5825MHz: 802.11a, 802.11n (HT20), 802.11ac (VHT20): 5 802.11n (HT40), 802.11ac (VHT40): 2 802.11ac (VHT80): 1
Output Power	5180 ~ 5240MHz: 227.012mW 5260 ~ 5320MHz: 226.045mW 5500 ~ 5720MHz: 250.036mW 5745 ~ 5825MHz: 276.314mW
Antenna Type	Refer to Note
Antenna Connector	Refer to Note
Accessory Device	Adapter, Remote controller, Mounting kit
Cable Supplied	Shielded HDMI cable (1.8m)

Note:

1. The EUT incorporates a MIMO function. Physically, the EUT provides 2 completed transmitters and 2 receivers.

Modulation Mode	TX Function
802.11a	2TX
802.11n (HT20)	2TX
802.11n (HT40)	2TX
802.11ac (VHT20)	2TX
802.11ac (VHT40)	2TX
802.11ac (VHT80)	2TX

* The modulation and bandwidth are similar for 802.11n mode for 20MHz/40MHz and 802.11ac mode for 20MHz/40MHz, therefore investigated worst case to representative mode in test report. (Final test mode refer section 3.2.1)

2. The EUT is powered by the following adapter.

Brand	NetBit
Model	NBS60E190342M2
Input Power	100~240Vac, 1.5A, 50-60Hz
Output Power	19.0Vdc, 3.42A
Power cable	Non-shielded DC cable (1.8m)

3. The following antennas were provided to the EUT.

No.	Type	Gain(dBi)		Connector
		2.4~2.4835GHz	5.15~5.85GHz	
1 (WLAN)	PCB	2.83	5.08	i-pex(MHF)
2 (WLAN/BT)	PCB	3.46	5.28	i-pex(MHF)

* The above Antenna information is declared by manufacturer and for more detailed features description, please refer to the manufacturer's specifications, the laboratory shall not be held responsible.

4. All RF characteristics can't transmit simultaneously.

3.2 Description of Test Modes

For 5180 ~ 5240MHz:

4 channels are provided for 802.11a, 802.11n (HT20), 802.11ac (VHT20):

Channel	Frequency	Channel	Frequency
36	5180 MHz	44	5220 MHz
40	5200 MHz	48	5240 MHz

2 channels are provided for 802.11n (HT40), 802.11ac (VHT40):

Channel	Frequency	Channel	Frequency
38	5190 MHz	46	5230 MHz

1 channel is provided for 802.11ac (VHT80):

Channel	Frequency
42	5210 MHz

For 5260 ~ 5320MHz:

4 channels are provided for 802.11a, 802.11n (HT20), 802.11ac (VHT20):

Channel	Frequency	Channel	Frequency
52	5260 MHz	60	5300 MHz
56	5280 MHz	64	5320 MHz

2 channels are provided for 802.11n (HT40), 802.11ac (VHT40):

Channel	Frequency	Channel	Frequency
54	5270 MHz	62	5310 MHz

1 channel is provided for 802.11ac (VHT80):

Channel	Frequency
58	5290 MHz

For 5500 ~ 5720MHz:

12 channels are provided for 802.11a, 802.11n (HT20), 802.11ac (VHT20):

Channel	Frequency	Channel	Frequency
100	5500 MHz	124	5620 MHz
104	5520 MHz	128	5640 MHz
108	5540 MHz	132	5660 MHz
112	5560 MHz	136	5680 MHz
116	5580 MHz	140	5700 MHz
120	5600 MHz	144	5720 MHz

6 channels are provided for 802.11n (HT40), 802.11ac (VHT40):

Channel	Frequency	Channel	Frequency
102	5510 MHz	126	5630 MHz
110	5550 MHz	134	5670 MHz
118	5590 MHz	142	5710 MHz

3 channels are provided for 802.11ac (VHT80):

Channel	Frequency	Channel	Frequency
106	5530 MHz	122	5610 MHz
138	5690 MHz		

For 5745 ~ 5825MHz:

5 channels are provided for 802.11a, 802.11n (HT20), 802.11ac (VHT20):

Channel	Frequency	Channel	Frequency
149	5745 MHz	161	5805 MHz
153	5765 MHz	165	5825 MHz
157	5785 MHz		

2 channels are provided for 802.11n (HT40), 802.11ac (VHT40):

Channel	Frequency	Channel	Frequency
151	5755 MHz	159	5795 MHz

1 channel is provided for 802.11ac (VHT80):

Channel	Frequency
155	5775 MHz

3.2.1 Test Mode Applicability and Tested Channel Detail

EUT Configure Mode	Applicable to				Description
	RE≥1G	RE<1G	PLC	APCM	
-	√	√	√	√	-

Where RE≥1G: Radiated Emission above 1GHz & Bandedge Measurement
 RE<1G: Radiated Emission below 1GHz
 PLC: Power Line Conducted Emission
 APCM: Antenna Port Conducted Measurement

Note: The antenna had been pre-tested on the positioned of each 3 axis. The worst case was found when positioned on X-plane.

Radiated Emission Test (Above 1GHz):

- Pre-Scan has been conducted to determine the worst-case mode from all possible combinations between available modulations, data rates and antenna ports (if EUT with antenna diversity architecture).
- Following channel(s) was (were) selected for the final test as listed below.

EUT Configure Mode	Mode	Frequency Band (MHz)	Available Channel	Tested Channel	Modulation Technology	Data Rate (Mbps)
-	802.11a	5180-5240	36 to 48	36, 40, 48	OFDM	6.0
	802.11n (HT20)		36 to 48	36, 40, 48	OFDM	6.5
	802.11n (HT40)		38 to 46	38, 46	OFDM	13.5
	802.11ac (VHT80)		42	42	OFDM	29.3
-	802.11a	5260-5320	52 to 64	52, 60, 64	OFDM	6.0
	802.11n (HT20)		52 to 64	52, 60, 64	OFDM	6.5
	802.11n (HT40)		54 to 62	54, 62	OFDM	13.5
	802.11ac (VHT80)		58	58	OFDM	29.3
-	802.11a	5500-5720	100 to 144	100, 116, 140, 144	OFDM	6.0
	802.11n (HT20)		100 to 144	100, 116, 140, 144	OFDM	6.5
	802.11n (HT40)		102 to 142	102, 110, 134, 142	OFDM	13.5
	802.11ac (VHT80)		106 to 138	106, 122, 138	OFDM	29.3
-	802.11a	5745-5825	149 to 165	149, 157, 165	OFDM	6.0
	802.11n (HT20)		149 to 165	149, 157, 165	OFDM	6.5
	802.11n (HT40)		151 to 159	151, 159	OFDM	13.5
	802.11ac (VHT80)		155	155	OFDM	29.3

Radiated Emission Test (Below 1GHz):

- Pre-Scan has been conducted to determine the worst-case mode from all possible combinations between available modulations, data rates and antenna ports (if EUT with antenna diversity architecture).
- Following channel(s) was (were) selected for the final test as listed below.

EUT Configure Mode	Mode	Frequency Band (MHz)	Available Channel	Tested Channel	Modulation Technology	Data Rate (Mbps)
-	802.11n (HT20)	5180-5240	36 to 48	64	OFDM	6.5
	802.11n (HT20)	5260-5320	52 to 64		OFDM	6.5
	802.11n (HT20)	5500-5720	100 to 144		OFDM	6.5
	802.11n (HT20)	5745-5825	149 to 165		OFDM	6.5

Power Line Conducted Emission Test:

- Pre-Scan has been conducted to determine the worst-case mode from all possible combinations between available modulations, data rates and antenna ports (if EUT with antenna diversity architecture).
- Following channel(s) was (were) selected for the final test as listed below.

EUT Configure Mode	Mode	Frequency Band (MHz)	Available Channel	Tested Channel	Modulation Technology	Data Rate (Mbps)
-	802.11n (HT20)	5180-5240	36 to 48	64	OFDM	6.5
	802.11n (HT20)	5260-5320	52 to 64		OFDM	6.5
	802.11n (HT20)	5500-5720	100 to 144		OFDM	6.5
	802.11n (HT20)	5745-5825	149 to 165		OFDM	6.5

Antenna Port Conducted Measurement:

- This item includes all test value of each mode, but only includes spectrum plot of worst value of each mode.
- Pre-Scan has been conducted to determine the worst-case mode from all possible combinations between available modulations, data rates and antenna ports (if EUT with antenna diversity architecture).
- Following channel(s) was (were) selected for the final test as listed below.

EUT Configure Mode	Mode	Frequency Band (MHz)	Available Channel	Tested Channel	Modulation Technology	Data Rate (Mbps)
-	802.11a	5180-5240	36 to 48	36, 40, 48	OFDM	6.0
	802.11n (HT20)		36 to 48	36, 40, 48	OFDM	6.5
	802.11n (HT40)		38 to 46	38, 46	OFDM	13.5
	802.11ac (VHT80)		42	42	OFDM	29.3
-	802.11a	5260-5320	52 to 64	52, 60, 64	OFDM	6.0
	802.11n (HT20)		52 to 64	52, 60, 64	OFDM	6.5
	802.11n (HT40)		54 to 62	54, 62	OFDM	13.5
	802.11ac (VHT80)		58	58	OFDM	29.3
-	802.11a	5500-5720	100 to 144	100, 116, 140, 144	OFDM	6.0
	802.11n (HT20)		100 to 144	100, 116, 140, 144	OFDM	6.5
	802.11n (HT40)		102 to 142	102, 110, 134, 142	OFDM	13.5
	802.11ac (VHT80)		106 to 138	106, 122, 138	OFDM	29.3
-	802.11a	5745-5825	149 to 165	149, 157, 165	OFDM	6.0
	802.11n (HT20)		149 to 165	149, 157, 165	OFDM	6.5
	802.11n (HT40)		151 to 159	151, 159	OFDM	13.5
	802.11ac (VHT80)		155	155	OFDM	29.3

Test Condition:

Applicable to	Environmental Conditions	Input Power	Tested by
RE \geq 1G	22 deg. C, 66% RH	120Vac, 60Hz	Han Wu, Greg Lin
RE<1G	21 deg. C, 68% RH	120Vac, 60Hz	Han Wu
PLC	25 deg. C, 75% RH	120Vac, 60Hz	Pirar Hsieh
APCM	25 deg. C, 60% RH	120Vac, 60Hz	Chris Lin

3.3 Duty Cycle of Test Signal

Duty cycle of test signal is $\geq 98\%$, duty factor is not required.

Duty cycle of test signal is $< 98\%$, duty factor is required.

802.11a: Duty cycle = $2.022/2.052 = 0.985$

802.11n (HT20): Duty cycle = $1.885/1.915 = 0.984$

802.11n (HT40): Duty cycle = $0.926/0.965 = 0.96$, Duty factor = $10 * \log(1/0.96) = 0.18$

802.11ac (VHT80): Duty cycle = $0.449/0.491 = 0.914$, Duty factor = $10 * \log(1/0.914) = 0.39$



3.4 Description of Support Units

The EUT has been tested as an independent unit together with other necessary accessories or support units. The following support units or accessories were used to form a representative test configuration during the tests.

For Power Line Conducted Emission Test:

ID	Product	Brand	Model No.	Serial No.	FCC ID	Remarks
A	LCD Monitor	Dell	S2817Q	CN-0GD45P-74445-724-116M	FCC DoC Approved	Provided by Lab
B	DVD Player*3	SONY	BDP-S7200	NA	NA	Provided by Lab
C	USB Dongle*3	SanDisk	SanDisk Ultra	NA	NA	Provided by Lab
D	USB Dongle	SanDisk	SanDisk Ultra	NA	NA	Provided by Lab
E	Earphone	PHILIPS	SBC HL150	H2010147	NA	Provided by Lab
F	Mobile Phone	SAMSUNG	SM-A505GN/DS	R58M74MNP1P	NA	Provided by Lab
G	Notebook	Lenove	81LG	PHNGBDP	FCC DoC Approved	Provided by Lab

Note:

1. All power cords of the above support units are non-shielded (1.8m).
2. Item G acted as a communication partner to transfer data.

ID	Descriptions	Qty.	Length (m)	Shielding (Yes/No)	Cores (Qty.)	Remarks
1	HDMI cable	1	1.8	Y	0	Accessory of EUT
2	HDMI cable	3	1.8	Y	0	Provided by Lab
3	Audio cable	1	1.2	Y	0	Provided by Lab
4	Audio cable	1	1.8	Y	0	Provided by Lab
5	RJ45 cable	1	10	N	0	Provided by Lab
6	DC cable	1	1.8	N	0	Supplied by client

For Radiated Emission Test

ID	Product	Brand	Model No.	Serial No.	FCC ID	Remarks
A	LCD Monitor	ViewSonic	VX2457-MHD	UG0182942333	FCC DoC Approved	Provided by Lab
B	DVD Player	SONY	DVP-NS975V	2030314	Verification	Provided by Lab
C	DVD Player	SONY	DVP-NS975V	2030869	Verification	Provided by Lab
D	Blue-Ray Player	SONY	BDP-S360	1005850	NA	Provided by Lab
E	USB Dongle	HP	v250W	05	NA	Provided by Lab
F	USB Dongle	HP	v250W	09	NA	Provided by Lab
G	USB Dongle	HP	v250W	02	NA	Provided by Lab
H	USB Dongle	SanDisk	SDDDC3	NA	NA	Provided by Lab
I	Earphone	PHILIPS	SBC HL150	NA	NA	Provided by Lab
J	Mobile Phone	SONY	LT28H	CB5A1KY97P	NA	Provided by Lab
K	Notebook	DELL	E5410	1HC2XM1	FCC DoC Approved	Provided by Lab

Note:

1. All power cords of the above support units are non-shielded (1.8m).
2. Item K acted as a communication partner to transfer data.

ID	Descriptions	Qty.	Length (m)	Shielding (Yes/No)	Cores (Qty.)	Remarks
1	HDMI cable	1	1.8	Y	0	Accessory of EUT
2	HDMI cable	2	1.8	Y	0	Provided by Lab
3	HDMI cable	1	1.8	Y	0	Provided by Lab
4	Audio cable	1	1.2	Y	0	Provided by Lab
5	Audio cable	1	1.8	Y	0	Provided by Lab
6	RJ45 cable	1	10	N	0	Provided by Lab
7	DC cable	1	1.8	N	0	Supplied by client

3.4.1 Configuration of System under Test

For Power Line Conducted Emission Test:

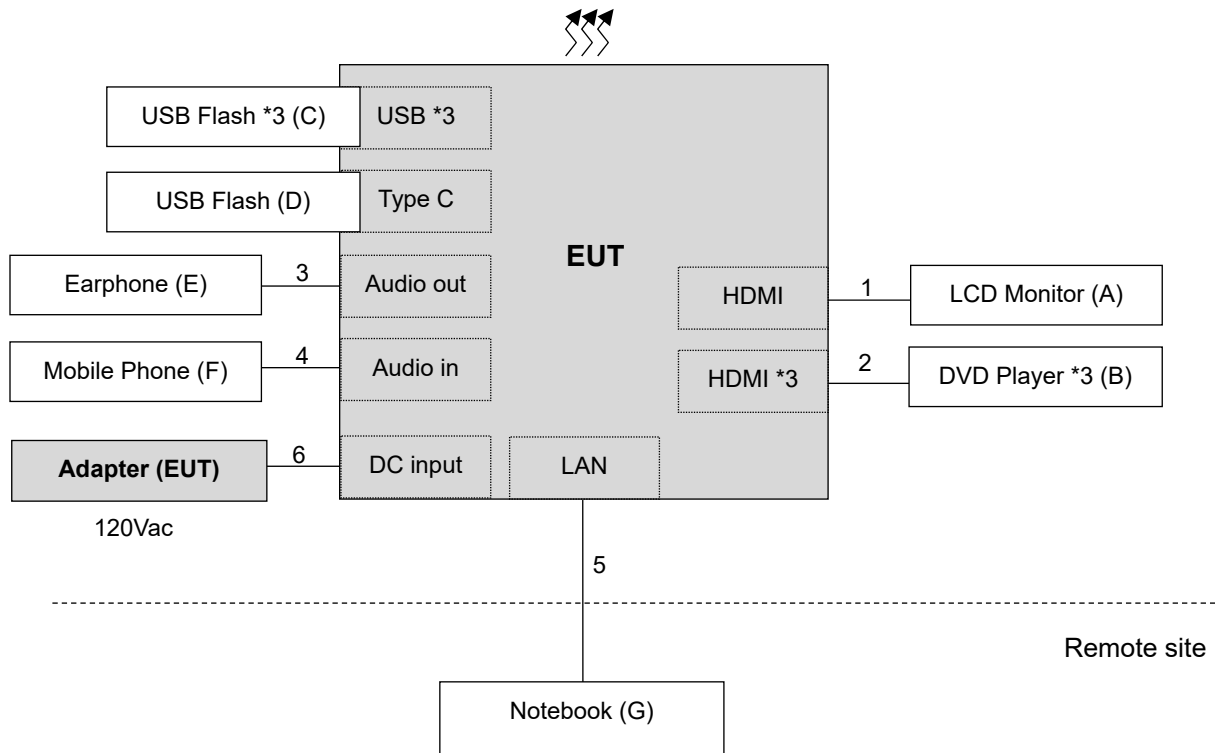

For Radiated Emission Test

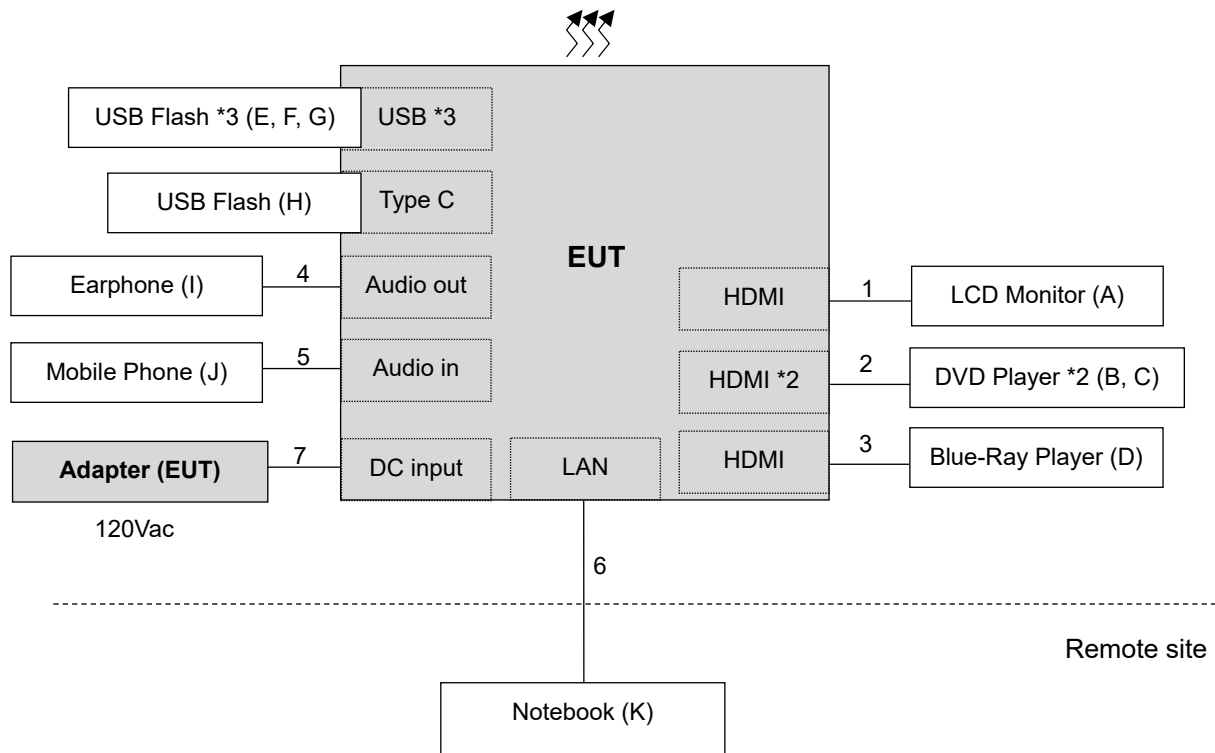

3.5 General Description of Applied Standards and References

The EUT is a RF Product. According to the specifications of the manufacturer, it must comply with the requirements of the following standards and references:

Test standard:

FCC Part 15, Subpart E (15.407)

ANSI C63.10:2013

All test items have been performed and recorded as per the above standards.

KDB References Test Guidance:

KDB 789033 D02 General UNII Test Procedure New Rules v02r01

KDB 662911 D01 Multiple Transmitter Output v02r01

All test items have been performed as a reference to the above KDB test guidance.

4 Test Types and Results

4.1 Radiated Emission and Bandedge Measurement

4.1.1 Limits of Radiated Emission and Bandedge Measurement

Radiated emissions which fall in the restricted bands must comply with the radiated emission limits specified as below table.

Frequencies (MHz)	Field Strength (microvolts/meter)	Measurement Distance (meters)
0.009 ~ 0.490	2400/F(kHz)	300
0.490 ~ 1.705	24000/F(kHz)	30
1.705 ~ 30.0	30	30
30 ~ 88	100	3
88 ~ 216	150	3
216 ~ 960	200	3
Above 960	500	3

Note:

1. The lower limit shall apply at the transition frequencies.
2. Emission level (dBuV/m) = 20 log Emission level (uV/m).
3. For frequencies above 1000MHz, the field strength limits are based on average detector, however, the peak field strength of any emission shall not exceed the maximum permitted average limits, specified above by more than 20dB under any condition of modulation.

Limits of unwanted emission out of the restricted bands

Applicable To		Limit	
789033 D02 General UNII Test Procedure New Rules v02r01		Field Strength at 3m	
		PK: 74 (dBµV/m)	AV: 54 (dBµV/m)
Frequency Band	Applicable To	EIRP Limit	Equivalent Field Strength at 3m
5150~5250 MHz	15.407(b)(1)	PK: -27 (dBm/MHz)	PK: 68.2(dBµV/m)
5250~5350 MHz	15.407(b)(2)		
5470~5725 MHz	15.407(b)(3)		
5725~5850 MHz	<input checked="" type="checkbox"/> 15.407(b)(4)(i)	PK: -27 (dBm/MHz) ^{*1} PK: 10 (dBm/MHz) ^{*2} PK: 15.6 (dBm/MHz) ^{*3} PK: 27 (dBm/MHz) ^{*4}	PK: 68.2(dBµV/m) ^{*1} PK: 105.2 (dBµV/m) ^{*2} PK: 110.8(dBµV/m) ^{*3} PK: 122.2 (dBµV/m) ^{*4}
	<input type="checkbox"/> 15.407(b)(4)(ii)	Emission limits in section 15.247(d)	
^{*1} beyond 75 MHz or more above of the band edge.		^{*2} below the band edge increasing linearly to 10 dBm/MHz at 25 MHz above.	
^{*3} below the band edge increasing linearly to a level of 15.6 dBm/MHz at 5 MHz above.		^{*4} from 5 MHz above or below the band edge increasing linearly to a level of 27 dBm/MHz at the band edge.	

Note: The following formula is used to convert the equipment isotropic radiated power (eirp) to field strength:

$$E = \frac{1000000 \sqrt{30P}}{3} \mu\text{V/m, where P is the eirp (Watts).}$$

4.1.2 Test Instruments

Description & Manufacturer	Model No.	Serial No.	Cal. Date	Cal. Due
Test Receiver KEYSIGHT	N9038A	MY55420137	Apr. 16, 2020	Apr. 15, 2021
Spectrum Analyzer ROHDE & SCHWARZ	FSP40	100039	Jun. 12, 2020	Jun. 11, 2021
BILOG Antenna SCHWARZBECK	VULB9168	9168-160	Nov. 06, 2020	Nov. 05, 2021
HORN Antenna SCHWARZBECK	BBHA 9120 D	9120D-1169	Nov. 22, 2020	Nov. 21, 2021
HORN Antenna SCHWARZBECK	BBHA 9170	BBHA9170241	Nov. 22, 2020	Nov. 21, 2021
Preamplifier Agilent (Below 1GHz)	8447D	2944A10638	Jun. 08, 2020	Jun. 07, 2021
Preamplifier Agilent (Above 1GHz)	8449B	3008A02367	Feb. 18, 2020	Feb. 17, 2021
RF signal cable HUBER+SUHNER&EMCI	SUCOFLEX 104 & EMC104-SM-SM8000	CABLE-CH9-02 (248780+171006)	Jan. 18, 2020	Jan. 17, 2021
RF signal cable HUBER+SUHNER	SUCOFLEX 104	CABLE-CH9-(250795/4)	Jan. 18, 2020	Jan. 17, 2021
RF signal cable Woken	8D-FB	Cable-CH9-01	Jun. 08, 2020	Jun. 07, 2021
Software BV ADT	ADT_Radiated_ V7.6.15.9.5	NA	NA	NA
Antenna Tower EMCO	2070/2080	512.835.4684	NA	NA
Turn Table EMCO	2087-2.03	NA	NA	NA
Antenna Tower & Turn BV ADT	AT100	AT93021705	NA	NA
Turn Table BV ADT	TT100	TT93021705	NA	NA
Turn Table Controller BV ADT	SC100	SC93021705	NA	NA
Boresight Antenna Fixture	FBA-01	FBA-SIP01	NA	NA
Pre-amplifier (18GHz-40GHz) EMC	EMC184045B	980175	Sep. 04, 2020	Sep. 03, 2021
USB Wideband Power Sensor KEYSIGHT	U2021XA	MY55050005/MY55190 004/MY55190007/MY55 210005	Jul. 13, 2020	Jul. 12, 2021

Note: 1. The calibration interval of the above test instruments is 12 months and the calibrations are traceable to NML/ROC and NIST/USA.
2. The test was performed in HwaYa Chamber 9.

4.1.3 Test Procedures

For Radiated emission below 30MHz

- a. The EUT was placed on the top of a rotating table 0.8 meters above the ground at a 3 meter chamber room. The table was rotated 360 degrees to determine the position of the highest radiation.
- b. The EUT was set 3 meters away from the interference-receiving antenna, which was mounted on the top of a variable-height antenna tower.
- c. Parallel, perpendicular, and ground-parallel orientations of the antenna are set to make the measurement.
- d. For each suspected emission, the EUT was arranged to its worst case and the rotatable table was turned from 0 degrees to 360 degrees to find the maximum reading.
- e. The test-receiver system was set to Quasi-Peak Detect Function and Specified Bandwidth with Maximum Hold Mode.

Note:

1. The resolution bandwidth and video bandwidth of test receiver/spectrum analyzer is 9kHz at frequency below 30MHz.

For Radiated emission above 30MHz

- a. The EUT was placed on the top of a rotating table 0.8 meters (for 30MHz ~ 1GHz) / 1.5 meters (for above 1GHz) above the ground at 3 meter chamber room for test. The table was rotated 360 degrees to determine the position of the highest radiation.
- b. The EUT was set 3 meters away from the interference-receiving antenna, which was mounted on the top of a variable-height antenna tower.
- c. The height of antenna is varied from one meter to four meters above the ground to determine the maximum value of the field strength. Both horizontal and vertical polarizations of the antenna are set to make the measurement.
- d. For each suspected emission, the EUT was arranged to its worst case and then the antenna was tuned to heights from 1 meter to 4 meters and the rotatable table was turned from 0 degrees to 360 degrees to find the maximum reading.
- e. The test-receiver system was set to quasi-peak detect function and specified bandwidth with maximum hold mode when the test frequency is below 1 GHz.
- f. The test-receiver system was set to peak and average detect function and specified bandwidth with maximum hold mode when the test frequency is above 1 GHz. If the peak reading value also meets average limit, measurement with the average detector is unnecessary.

Note:

1. The resolution bandwidth and video bandwidth of test receiver/spectrum analyzer is 120kHz for Quasi-peak detection (QP) at frequency below 1GHz.
2. The resolution bandwidth of test receiver/spectrum analyzer is 1 MHz and the video bandwidth is 3 MHz for Peak detection (PK) at frequency above 1GHz.
3. The resolution bandwidth of test receiver/spectrum analyzer is 1MHz and the video bandwidth is $\geq 1/T$ (Duty cycle < 98%) or 10Hz (Duty cycle $\geq 98\%$) for Average detection (AV) at frequency above 1GHz.
(802.11a: RBW = 1MHz, VBW = 10Hz; 802.11n (HT20): RBW = 1MHz, VBW = 10Hz;
802.11n (HT40): RBW = 1MHz, VBW = 3kHz; 802.11ac (VHT80): RBW = 1MHz, VBW = 3kHz)
4. All modes of operation were investigated and the worst-case emissions are reported.

4.1.4 Deviation from Test Standard

No deviation.

4.1.5 Test Setup

For Radiated emission below 30MHz

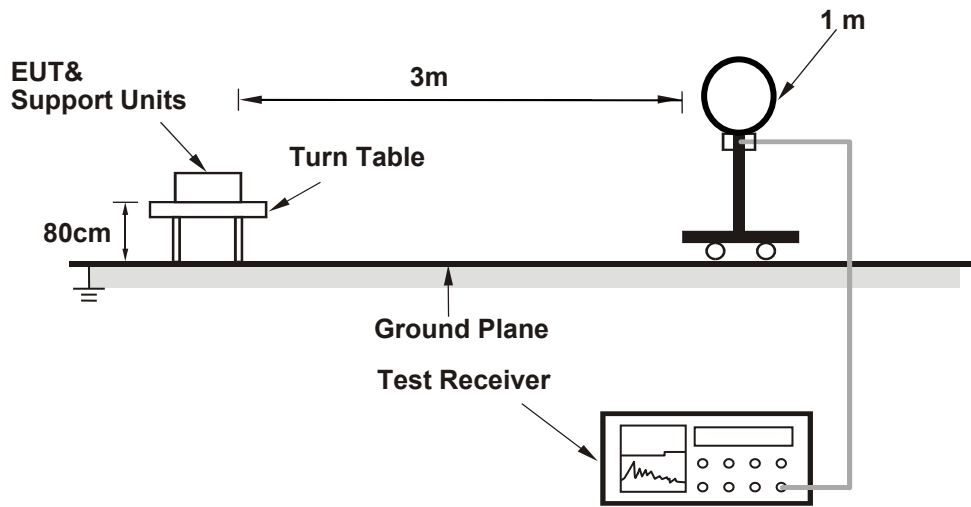

For Radiated emission 30MHz to 1GHz

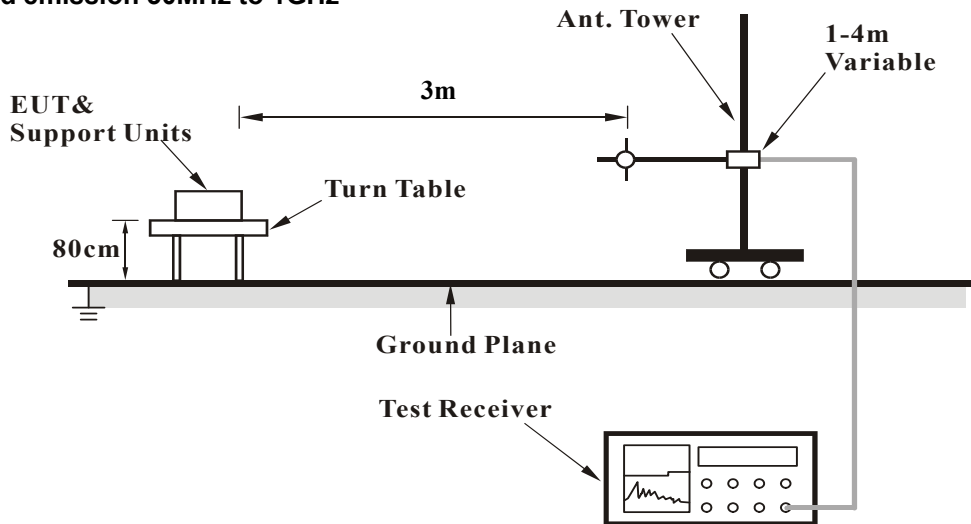

For Radiated emission above 1GHz

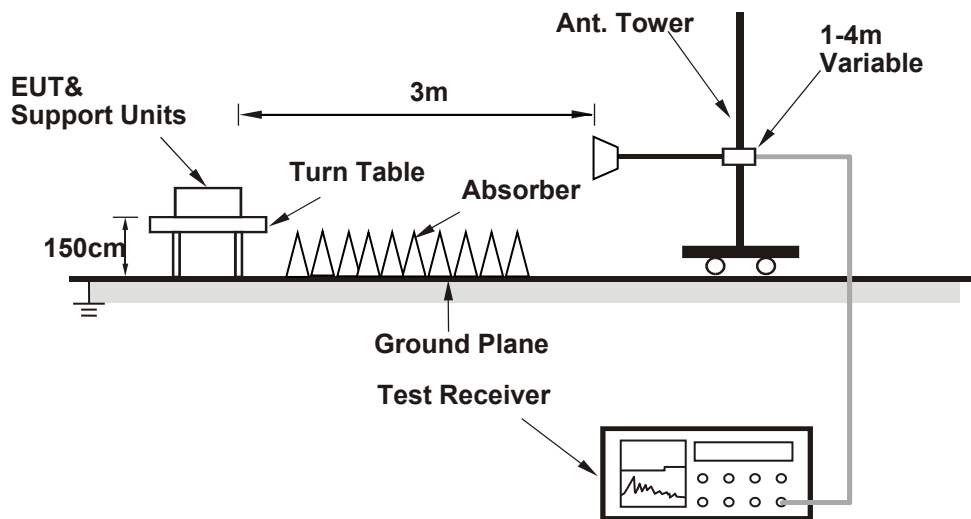

For the actual test configuration, please refer to the attached file (Test Setup Photo).

4.1.6 EUT Operating Conditions

- Placed the EUT on the testing table.
- Prepared notebook to act as communication partner and placed it outside of testing area.
- The communication partner connected with EUT via a RJ45 cable and ran a test program (provided by manufacturer) to enable EUT under transmission condition continuously at specific channel frequency.
- The necessary accessories enable the system in full functions

4.1.7 Test Results

Above 1GHz data:

RF Mode	TX 802.11a	Channel	CH 36 : 5180 MHz
Frequency Range	1GHz ~ 40GHz	Detector Function	Peak (PK) Average (AV)

Antenna Polarity & Test Distance : Horizontal at 3 m								
No	Frequency (MHz)	Emission Level (dBuV/m)	Limit (dBuV/m)	Margin (dB)	Antenna Height (m)	Table Angle (Degree)	Raw Value (dBuV)	Correction Factor (dB/m)
1	5150.00	69.7 PK	74.0	-4.3	2.03 H	2	67.5	2.2
2	5150.00	51.9 AV	54.0	-2.1	2.03 H	2	49.7	2.2
3	*5180.00	115.7 PK			2.03 H	2	79.3	36.4
4	*5180.00	106.3 AV			2.03 H	2	69.9	36.4
5	#10360.00	58.8 PK	68.2	-9.4	1.01 H	26	43.6	15.2

Antenna Polarity & Test Distance : Vertical at 3 m								
No	Frequency (MHz)	Emission Level (dBuV/m)	Limit (dBuV/m)	Margin (dB)	Antenna Height (m)	Table Angle (Degree)	Raw Value (dBuV)	Correction Factor (dB/m)
1	5150.00	56.4 PK	74.0	-17.6	1.00 V	30	54.2	2.2
2	5150.00	45.4 AV	54.0	-8.6	1.00 V	30	43.2	2.2
3	*5180.00	105.7 PK			1.00 V	30	69.3	36.4
4	*5180.00	96.5 AV			1.00 V	30	60.1	36.4
5	#10360.00	61.2 PK	68.2	-7.0	1.00 V	70	46.0	15.2

Remarks:

1. Emission Level(dBuV/m) = Raw Value(dBuV) + Correction Factor(dB/m)
2. Correction Factor(dB/m) = Antenna Factor(dB/m) + Cable Factor(dB) – Pre-Amplifier Factor(dB)
3. Margin value = Emission Level – Limit value
4. The other emission levels were very low against the limit.
5. " * ": Fundamental frequency.
6. " # ": The radiated frequency is out of the restricted band.

RF Mode	TX 802.11a	Channel	CH 40 : 5200 MHz
Frequency Range	1GHz ~ 40GHz	Detector Function	Peak (PK) Average (AV)

Antenna Polarity & Test Distance : Horizontal at 3 m

No	Frequency (MHz)	Emission Level (dBuV/m)	Limit (dBuV/m)	Margin (dB)	Antenna Height (m)	Table Angle (Degree)	Raw Value (dBuV)	Correction Factor (dB/m)
1	*5200.00	117.2 PK			2.23 H	4	80.8	36.4
2	*5200.00	107.3 AV			2.23 H	4	70.9	36.4
3	#10400.00	60.6 PK	68.2	-7.6	1.07 H	20	45.4	15.2

Antenna Polarity & Test Distance : Vertical at 3 m

No	Frequency (MHz)	Emission Level (dBuV/m)	Limit (dBuV/m)	Margin (dB)	Antenna Height (m)	Table Angle (Degree)	Raw Value (dBuV)	Correction Factor (dB/m)
1	*5200.00	105.7 PK			1.03 V	32	69.3	36.4
2	*5200.00	96.3 AV			1.03 V	32	59.9	36.4
3	#10400.00	64.3 PK	68.2	-3.9	1.14 V	69	49.1	15.2

Remarks:

1. Emission Level(dBuV/m) = Raw Value(dBuV) + Correction Factor(dB/m)
2. Correction Factor(dB/m) = Antenna Factor(dB/m) + Cable Factor(dB) – Pre-Amplifier Factor(dB)
3. Margin value = Emission Level – Limit value
4. The other emission levels were very low against the limit.
5. " * " : Fundamental frequency.
6. " # " : The radiated frequency is out of the restricted band.

RF Mode	TX 802.11a	Channel	CH 48 : 5240 MHz
Frequency Range	1GHz ~ 40GHz	Detector Function	Peak (PK) Average (AV)

Antenna Polarity & Test Distance : Horizontal at 3 m

No	Frequency (MHz)	Emission Level (dBuV/m)	Limit (dBuV/m)	Margin (dB)	Antenna Height (m)	Table Angle (Degree)	Raw Value (dBuV)	Correction Factor (dB/m)
1	*5240.00	116.9 PK			1.89 H	13	80.6	36.3
2	*5240.00	107.5 AV			1.89 H	13	71.2	36.3
3	5350.00	53.5 PK	74.0	-20.5	1.89 H	13	51.5	2.0
4	5350.00	39.1 AV	54.0	-14.9	1.89 H	13	37.1	2.0
5	#10480.00	58.1 PK	74.0	-15.9	1.15 H	31	43.0	15.1
6	#10480.00	45.4 AV	54.0	-8.6	1.15 H	31	30.3	15.1

Antenna Polarity & Test Distance : Vertical at 3 m

No	Frequency (MHz)	Emission Level (dBuV/m)	Limit (dBuV/m)	Margin (dB)	Antenna Height (m)	Table Angle (Degree)	Raw Value (dBuV)	Correction Factor (dB/m)
1	*5240.00	104.7 PK			1.15 V	31	68.4	36.3
2	*5240.00	95.5 AV			1.15 V	31	59.2	36.3
3	5350.00	50.0 PK	74.0	-24.0	1.15 V	31	48.0	2.0
4	5350.00	38.2 AV	54.0	-15.8	1.15 V	31	36.2	2.0
5	#10480.00	63.6 PK	68.2	-4.6	1.22 V	69	48.5	15.1

Remarks:

1. Emission Level(dBuV/m) = Raw Value(dBuV) + Correction Factor(dB/m)
2. Correction Factor(dB/m) = Antenna Factor(dB/m) + Cable Factor(dB) – Pre-Amplifier Factor(dB)
3. Margin value = Emission Level – Limit value
4. The other emission levels were very low against the limit.
5. " * " : Fundamental frequency.
6. " # " : The radiated frequency is out of the restricted band.

RF Mode	TX 802.11a	Channel	CH 52 : 5260 MHz
Frequency Range	1GHz ~ 40GHz	Detector Function	Peak (PK) Average (AV)

Antenna Polarity & Test Distance : Horizontal at 3 m

No	Frequency (MHz)	Emission Level (dBuV/m)	Limit (dBuV/m)	Margin (dB)	Antenna Height (m)	Table Angle (Degree)	Raw Value (dBuV)	Correction Factor (dB/m)
1	5150.00	50.8 PK	74.0	-23.2	1.82 H	11	48.6	2.2
2	5150.00	38.9 AV	54.0	-15.1	1.82 H	11	36.7	2.2
3	*5260.00	116.8 PK			1.82 H	11	80.6	36.2
4	*5260.00	107.1 AV			1.82 H	11	70.9	36.2
5	#10520.00	59.4 PK	68.2	-8.8	1.00 H	68	44.2	15.2

Antenna Polarity & Test Distance : Vertical at 3 m

No	Frequency (MHz)	Emission Level (dBuV/m)	Limit (dBuV/m)	Margin (dB)	Antenna Height (m)	Table Angle (Degree)	Raw Value (dBuV)	Correction Factor (dB/m)
1	5150.00	52.6 PK	74.0	-21.4	1.07 V	27	50.4	2.2
2	5150.00	39.2 AV	54.0	-14.8	1.07 V	27	37.0	2.2
3	*5260.00	106.2 PK			1.07 V	28	70.0	36.2
4	*5260.00	96.9 AV			1.07 V	28	60.7	36.2
5	#10520.00	62.7 PK	68.2	-5.5	1.07 V	78	47.5	15.2

Remarks:

1. Emission Level(dBuV/m) = Raw Value(dBuV) + Correction Factor(dB/m)
2. Correction Factor(dB/m) = Antenna Factor(dB/m) + Cable Factor(dB) – Pre-Amplifier Factor(dB)
3. Margin value = Emission Level – Limit value
4. The other emission levels were very low against the limit.
5. " * ": Fundamental frequency.
6. " # ": The radiated frequency is out of the restricted band.

RF Mode	TX 802.11a	Channel	CH 60 : 5300 MHz
Frequency Range	1GHz ~ 40GHz	Detector Function	Peak (PK) Average (AV)

Antenna Polarity & Test Distance : Horizontal at 3 m

No	Frequency (MHz)	Emission Level (dBuV/m)	Limit (dBuV/m)	Margin (dB)	Antenna Height (m)	Table Angle (Degree)	Raw Value (dBuV)	Correction Factor (dB/m)
1	*5300.00	118.3 PK			1.61 H	4	82.3	36.0
2	*5300.00	107.9 AV			1.61 H	4	71.9	36.0
3	10600.00	59.1 PK	74.0	-14.9	1.26 H	67	43.4	15.7
4	10600.00	48.6 AV	54.0	-5.4	1.26 H	67	32.9	15.7

Antenna Polarity & Test Distance : Vertical at 3 m

No	Frequency (MHz)	Emission Level (dBuV/m)	Limit (dBuV/m)	Margin (dB)	Antenna Height (m)	Table Angle (Degree)	Raw Value (dBuV)	Correction Factor (dB/m)
1	*5300.00	103.2 PK			1.40 V	31	67.2	36.0
2	*5300.00	94.7 AV			1.40 V	31	58.7	36.0
3	10600.00	60.5 PK	74.0	-13.5	1.04 V	74	44.8	15.7
4	10600.00	48.0 AV	54.0	-6.0	1.04 V	74	32.3	15.7

Remarks:

1. Emission Level(dBuV/m) = Raw Value(dBuV) + Correction Factor(dB/m)
2. Correction Factor(dB/m) = Antenna Factor(dB/m) + Cable Factor(dB) – Pre-Amplifier Factor(dB)
3. Margin value = Emission Level – Limit value
4. The other emission levels were very low against the limit.
5. " * " : Fundamental frequency.

RF Mode	TX 802.11a	Channel	CH 64 : 5320 MHz
Frequency Range	1GHz ~ 40GHz	Detector Function	Peak (PK) Average (AV)

Antenna Polarity & Test Distance : Horizontal at 3 m

No	Frequency (MHz)	Emission Level (dBuV/m)	Limit (dBuV/m)	Margin (dB)	Antenna Height (m)	Table Angle (Degree)	Raw Value (dBuV)	Correction Factor (dB/m)
1	*5320.00	115.9 PK			1.66 H	5	79.7	36.2
2	*5320.00	105.6 AV			1.66 H	5	69.4	36.2
3	5350.00	71.9 PK	74.0	-2.1	1.66 H	5	69.9	2.0
4	5350.00	44.8 AV	54.0	-9.2	1.66 H	5	42.8	2.0
5	10640.00	60.5 PK	74.0	-13.5	1.08 H	73	44.7	15.8
6	10640.00	46.2 AV	54.0	-7.8	1.08 H	73	30.4	15.8

Antenna Polarity & Test Distance : Vertical at 3 m

No	Frequency (MHz)	Emission Level (dBuV/m)	Limit (dBuV/m)	Margin (dB)	Antenna Height (m)	Table Angle (Degree)	Raw Value (dBuV)	Correction Factor (dB/m)
1	*5320.00	104.5 PK			1.56 V	31	68.3	36.2
2	*5320.00	95.7 AV			1.56 V	31	59.5	36.2
3	5350.00	61.5 PK	74.0	-12.5	1.56 V	31	59.5	2.0
4	5350.00	48.5 AV	54.0	-5.5	1.56 V	31	46.5	2.0
5	10640.00	62.3 PK	74.0	-11.7	1.11 V	77	46.5	15.8
6	10640.00	52.0 AV	54.0	-2.0	1.11 V	77	36.2	15.8

Remarks:

1. Emission Level(dBuV/m) = Raw Value(dBuV) + Correction Factor(dB/m)
2. Correction Factor(dB/m) = Antenna Factor(dB/m) + Cable Factor(dB) – Pre-Amplifier Factor(dB)
3. Margin value = Emission Level – Limit value
4. The other emission levels were very low against the limit.
5. " * ": Fundamental frequency.

RF Mode	TX 802.11a	Channel	CH 100 : 5500 MHz
Frequency Range	1GHz ~ 40GHz	Detector Function	Peak (PK) Average (AV)

Antenna Polarity & Test Distance : Horizontal at 3 m

No	Frequency (MHz)	Emission Level (dBuV/m)	Limit (dBuV/m)	Margin (dB)	Antenna Height (m)	Table Angle (Degree)	Raw Value (dBuV)	Correction Factor (dB/m)
1	5460.00	59.2 PK	74.0	-14.8	1.39 H	2	56.4	2.8
2	5460.00	42.8 AV	54.0	-11.2	1.39 H	2	40.0	2.8
3	#5470.00	66.2 PK	68.2	-2.0	1.39 H	2	63.4	2.8
4	*5500.00	113.2 PK			1.39 H	2	76.2	37.0
5	*5500.00	104.6 AV			1.39 H	2	67.6	37.0
6	11000.00	55.5 PK	74.0	-18.5	1.42 H	92	38.5	17.0
7	11000.00	44.4 AV	54.0	-9.6	1.42 H	92	27.4	17.0

Antenna Polarity & Test Distance : Vertical at 3 m

No	Frequency (MHz)	Emission Level (dBuV/m)	Limit (dBuV/m)	Margin (dB)	Antenna Height (m)	Table Angle (Degree)	Raw Value (dBuV)	Correction Factor (dB/m)
1	5460.00	57.4 PK	74.0	-16.6	2.24 V	29	54.0	3.4
2	5460.00	44.0 AV	54.0	-10.0	2.24 V	29	40.6	3.4
3	#5470.00	65.2 PK	68.2	-3.0	2.24 V	29	61.8	3.4
4	*5500.00	110.3 PK			2.24 V	29	72.7	37.6
5	*5500.00	100.9 AV			2.24 V	29	63.3	37.6
6	#5725.00	62.7 PK	68.2	-5.5	2.24 V	29	59.2	3.5
7	11000.00	55.0 PK	74.0	-19.0	1.10 V	46	38.5	16.5
8	11000.00	44.1 AV	54.0	-9.9	1.10 V	46	27.6	16.5

Remarks:

1. Emission Level(dBuV/m) = Raw Value(dBuV) + Correction Factor(dB/m)
2. Correction Factor(dB/m) = Antenna Factor(dB/m) + Cable Factor(dB) – Pre-Amplifier Factor(dB)
3. Margin value = Emission Level – Limit value
4. The other emission levels were very low against the limit.
5. " * ": Fundamental frequency.
6. " # ": The radiated frequency is out of the restricted band.

RF Mode	TX 802.11a	Channel	CH 116 : 5580 MHz
Frequency Range	1GHz ~ 40GHz	Detector Function	Peak (PK) Average (AV)

Antenna Polarity & Test Distance : Horizontal at 3 m

No	Frequency (MHz)	Emission Level (dBuV/m)	Limit (dBuV/m)	Margin (dB)	Antenna Height (m)	Table Angle (Degree)	Raw Value (dBuV)	Correction Factor (dB/m)
1	*5580.00	116.2 PK			1.74 H	10	79.2	37.0
2	*5580.00	107.0 AV			1.74 H	10	70.0	37.0
3	11160.00	55.4 PK	74.0	-18.6	1.49 H	98	39.4	16.0
4	11160.00	43.7 AV	54.0	-10.3	1.49 H	98	27.7	16.0

Antenna Polarity & Test Distance : Vertical at 3 m

No	Frequency (MHz)	Emission Level (dBuV/m)	Limit (dBuV/m)	Margin (dB)	Antenna Height (m)	Table Angle (Degree)	Raw Value (dBuV)	Correction Factor (dB/m)
1	*5580.00	104.6 PK			2.30 V	38	67.1	37.5
2	*5580.00	96.1 AV			2.30 V	38	58.6	37.5
3	11160.00	55.0 PK	74.0	-19.0	1.08 V	45	38.4	16.6
4	11160.00	43.8 AV	54.0	-10.2	1.08 V	45	27.2	16.6

Remarks:

1. Emission Level(dBuV/m) = Raw Value(dBuV) + Correction Factor(dB/m)
2. Correction Factor(dB/m) = Antenna Factor(dB/m) + Cable Factor(dB) – Pre-Amplifier Factor(dB)
3. Margin value = Emission Level – Limit value
4. The other emission levels were very low against the limit.
5. " * ": Fundamental frequency.

RF Mode	TX 802.11a	Channel	CH 140 : 5700 MHz
Frequency Range	1GHz ~ 40GHz	Detector Function	Peak (PK) Average (AV)

Antenna Polarity & Test Distance : Horizontal at 3 m

No	Frequency (MHz)	Emission Level (dBuV/m)	Limit (dBuV/m)	Margin (dB)	Antenna Height (m)	Table Angle (Degree)	Raw Value (dBuV)	Correction Factor (dB/m)
1	*5700.00	114.6 PK			1.55 H	13	77.4	37.2
2	*5700.00	105.5 AV			1.55 H	13	68.3	37.2
3	#5725.00	66.2 PK	68.2	-2.0	1.55 H	13	63.2	3.0
4	11400.00	54.9 PK	74.0	-19.1	1.38 H	86	38.6	16.3
5	11400.00	43.4 AV	54.0	-10.6	1.38 H	86	27.1	16.3

Antenna Polarity & Test Distance : Vertical at 3 m

No	Frequency (MHz)	Emission Level (dBuV/m)	Limit (dBuV/m)	Margin (dB)	Antenna Height (m)	Table Angle (Degree)	Raw Value (dBuV)	Correction Factor (dB/m)
1	*5700.00	110.4 PK			2.21 V	30	72.7	37.7
2	*5700.00	100.6 AV			2.21 V	30	62.9	37.7
3	#5725.00	65.9 PK	68.2	-2.3	2.21 V	30	62.4	3.5
4	11400.00	54.3 PK	74.0	-19.7	1.06 V	52	38.3	16.0
5	11400.00	43.2 AV	54.0	-10.8	1.06 V	52	27.2	16.0

Remarks:

1. Emission Level(dBuV/m) = Raw Value(dBuV) + Correction Factor(dB/m)
2. Correction Factor(dB/m) = Antenna Factor(dB/m) + Cable Factor(dB) – Pre-Amplifier Factor(dB)
3. Margin value = Emission Level – Limit value
4. The other emission levels were very low against the limit.
5. " * ": Fundamental frequency.
6. " # ": The radiated frequency is out of the restricted band.

RF Mode	TX 802.11a	Channel	CH 144 : 5720 MHz
Frequency Range	1GHz ~ 40GHz	Detector Function	Peak (PK) Average (AV)

Antenna Polarity & Test Distance : Horizontal at 3 m

No	Frequency (MHz)	Emission Level (dBuV/m)	Limit (dBuV/m)	Margin (dB)	Antenna Height (m)	Table Angle (Degree)	Raw Value (dBuV)	Correction Factor (dB/m)
1	*5720.00	114.5 PK			1.75 H	12	77.2	37.3
2	*5720.00	105.7 AV			1.75 H	12	68.4	37.3
3	#5850.00	54.7 PK	68.2	-13.5	1.75 H	12	51.2	3.5
4	11440.00	54.5 PK	74.0	-19.5	1.52 H	95	38.5	16.0
5	11440.00	43.4 AV	54.0	-10.6	1.52 H	95	27.4	16.0

Antenna Polarity & Test Distance : Vertical at 3 m

No	Frequency (MHz)	Emission Level (dBuV/m)	Limit (dBuV/m)	Margin (dB)	Antenna Height (m)	Table Angle (Degree)	Raw Value (dBuV)	Correction Factor (dB/m)
1	*5720.00	109.4 PK			2.36 V	32	71.6	37.8
2	*5720.00	100.0 AV			2.36 V	32	62.2	37.8
3	#5850.00	52.2 PK	68.2	-16.0	2.35 V	32	48.1	4.1
4	11440.00	54.4 PK	74.0	-19.6	1.11 V	44	38.4	16.0
5	11440.00	43.3 AV	54.0	-10.7	1.11 V	44	27.3	16.0

Remarks:

1. Emission Level(dBuV/m) = Raw Value(dBuV) + Correction Factor(dB/m)
2. Correction Factor(dB/m) = Antenna Factor(dB/m) + Cable Factor(dB) – Pre-Amplifier Factor(dB)
3. Margin value = Emission Level – Limit value
4. The other emission levels were very low against the limit.
5. " * " : Fundamental frequency.
6. " # " : The radiated frequency is out of the restricted band.

RF Mode	TX 802.11a	Channel	CH 149 : 5745 MHz
Frequency Range	1GHz ~ 40GHz	Detector Function	Peak (PK) Average (AV)

Antenna Polarity & Test Distance : Horizontal at 3 m

No	Frequency (MHz)	Emission Level (dBuV/m)	Limit (dBuV/m)	Margin (dB)	Antenna Height (m)	Table Angle (Degree)	Raw Value (dBuV)	Correction Factor (dB/m)
1	#5644.40	53.0 PK	68.2	-15.2	2.15 H	17	50.2	2.8
2	*5745.00	116.5 PK			2.15 H	17	79.2	37.3
3	*5745.00	107.1 AV			2.15 H	17	69.8	37.3
4	#5987.60	53.3 PK	68.2	-14.9	2.15 H	17	49.9	3.4
5	11490.00	57.1 PK	74.0	-16.9	1.08 H	29	41.3	15.8
6	11490.00	44.1 AV	54.0	-9.9	1.08 H	29	28.3	15.8

Antenna Polarity & Test Distance : Vertical at 3 m

No	Frequency (MHz)	Emission Level (dBuV/m)	Limit (dBuV/m)	Margin (dB)	Antenna Height (m)	Table Angle (Degree)	Raw Value (dBuV)	Correction Factor (dB/m)
1	#5640.80	53.3 PK	68.2	-14.9	1.03 V	43	50.5	2.8
2	*5745.00	107.4 PK			1.03 V	43	70.1	37.3
3	*5745.00	97.9 AV			1.03 V	43	60.6	37.3
4	#5971.60	53.8 PK	68.2	-14.4	1.03 V	43	50.4	3.4
5	11490.00	57.9 PK	74.0	-16.1	1.00 V	55	42.1	15.8
6	11490.00	44.3 AV	54.0	-9.7	1.00 V	55	28.5	15.8

Remarks:

1. Emission Level(dBuV/m) = Raw Value(dBuV) + Correction Factor(dB/m)
2. Correction Factor(dB/m) = Antenna Factor(dB/m) + Cable Factor(dB) – Pre-Amplifier Factor(dB)
3. Margin value = Emission Level – Limit value
4. The other emission levels were very low against the limit.
5. " * " : Fundamental frequency.
6. " # " : The radiated frequency is out of the restricted band.

RF Mode	TX 802.11a	Channel	CH 157 : 5785 MHz
Frequency Range	1GHz ~ 40GHz	Detector Function	Peak (PK) Average (AV)

Antenna Polarity & Test Distance : Horizontal at 3 m

No	Frequency (MHz)	Emission Level (dBuV/m)	Limit (dBuV/m)	Margin (dB)	Antenna Height (m)	Table Angle (Degree)	Raw Value (dBuV)	Correction Factor (dB/m)
1	#5617.60	54.3 PK	68.2	-13.9	2.10 H	16	51.6	2.7
2	*5785.00	116.3 PK			2.10 H	16	78.8	37.5
3	*5785.00	106.7 AV			2.10 H	16	69.2	37.5
4	#5955.60	53.9 PK	68.2	-14.3	2.10 H	16	50.4	3.5
5	11570.00	56.8 PK	74.0	-17.2	1.13 H	32	41.4	15.4
6	11570.00	43.6 AV	54.0	-10.4	1.13 H	32	28.2	15.4

Antenna Polarity & Test Distance : Vertical at 3 m

No	Frequency (MHz)	Emission Level (dBuV/m)	Limit (dBuV/m)	Margin (dB)	Antenna Height (m)	Table Angle (Degree)	Raw Value (dBuV)	Correction Factor (dB/m)
1	#5632.00	52.6 PK	68.2	-15.6	1.03 V	37	49.9	2.7
2	*5785.00	107.6 PK			1.03 V	37	70.1	37.5
3	*5785.00	97.8 AV			1.03 V	37	60.3	37.5
4	#5961.60	53.0 PK	68.2	-15.2	1.03 V	37	49.5	3.5
5	11570.00	57.6 PK	74.0	-16.4	1.03 V	59	42.2	15.4
6	11570.00	43.8 AV	54.0	-10.2	1.03 V	59	28.4	15.4

Remarks:

1. Emission Level(dBuV/m) = Raw Value(dBuV) + Correction Factor(dB/m)
2. Correction Factor(dB/m) = Antenna Factor(dB/m) + Cable Factor(dB) – Pre-Amplifier Factor(dB)
3. Margin value = Emission Level – Limit value
4. The other emission levels were very low against the limit.
5. " * " : Fundamental frequency.
6. " # " : The radiated frequency is out of the restricted band.

RF Mode	TX 802.11a	Channel	CH 165 : 5825 MHz
Frequency Range	1GHz ~ 40GHz	Detector Function	Peak (PK) Average (AV)

Antenna Polarity & Test Distance : Horizontal at 3 m

No	Frequency (MHz)	Emission Level (dBuV/m)	Limit (dBuV/m)	Margin (dB)	Antenna Height (m)	Table Angle (Degree)	Raw Value (dBuV)	Correction Factor (dB/m)
1	#5647.60	53.3 PK	68.2	-14.9	1.98 H	24	50.5	2.8
2	*5825.00	115.2 PK			1.98 H	24	77.6	37.6
3	*5825.00	105.5 AV			1.98 H	24	67.9	37.6
4	#5999.20	54.2 PK	68.2	-14.0	1.98 H	24	50.8	3.4
5	11650.00	56.6 PK	74.0	-17.4	1.19 H	34	41.1	15.5
6	11650.00	43.5 AV	54.0	-10.5	1.19 H	34	28.0	15.5

Antenna Polarity & Test Distance : Vertical at 3 m

No	Frequency (MHz)	Emission Level (dBuV/m)	Limit (dBuV/m)	Margin (dB)	Antenna Height (m)	Table Angle (Degree)	Raw Value (dBuV)	Correction Factor (dB/m)
1	#5600.40	52.8 PK	68.2	-15.4	1.08 V	33	50.1	2.7
2	*5825.00	106.8 PK			1.08 V	33	69.2	37.6
3	*5825.00	97.0 AV			1.08 V	33	59.4	37.6
4	#5977.60	53.7 PK	68.2	-14.5	1.08 V	33	50.3	3.4
5	11650.00	57.9 PK	74.0	-16.1	1.00 V	67	42.4	15.5
6	11650.00	44.1 AV	54.0	-9.9	1.00 V	67	28.6	15.5

Remarks:

1. Emission Level(dBuV/m) = Raw Value(dBuV) + Correction Factor(dB/m)
2. Correction Factor(dB/m) = Antenna Factor(dB/m) + Cable Factor(dB) – Pre-Amplifier Factor(dB)
3. Margin value = Emission Level – Limit value
4. The other emission levels were very low against the limit.
5. " * ": Fundamental frequency.
6. " # ": The radiated frequency is out of the restricted band.

RF Mode	TX 802.11n (HT20)	Channel	CH 36 : 5180 MHz
Frequency Range	1GHz ~ 40GHz	Detector Function	Peak (PK) Average (AV)

Antenna Polarity & Test Distance : Horizontal at 3 m

No	Frequency (MHz)	Emission Level (dBuV/m)	Limit (dBuV/m)	Margin (dB)	Antenna Height (m)	Table Angle (Degree)	Raw Value (dBuV)	Correction Factor (dB/m)
1	5150.00	67.5 PK	74.0	-6.5	2.04 H	12	65.3	2.2
2	5150.00	53.0 AV	54.0	-1.0	2.04 H	12	50.8	2.2
3	*5180.00	115.6 PK			2.04 H	12	79.2	36.4
4	*5180.00	105.3 AV			2.04 H	12	68.9	36.4
5	#10360.00	55.2 PK	68.2	-13.0	1.13 H	12	40.0	15.2

Antenna Polarity & Test Distance : Vertical at 3 m

No	Frequency (MHz)	Emission Level (dBuV/m)	Limit (dBuV/m)	Margin (dB)	Antenna Height (m)	Table Angle (Degree)	Raw Value (dBuV)	Correction Factor (dB/m)
1	5150.00	56.0 PK	74.0	-18.0	1.14 V	28	53.8	2.2
2	5150.00	43.5 AV	54.0	-10.5	1.14 V	28	41.3	2.2
3	*5180.00	104.7 PK			1.14 V	28	68.3	36.4
4	*5180.00	94.1 AV			1.14 V	28	57.7	36.4
5	#10360.00	62.0 PK	68.2	-6.2	1.05 V	75	46.8	15.2

Remarks:

1. Emission Level(dBuV/m) = Raw Value(dBuV) + Correction Factor(dB/m)
2. Correction Factor(dB/m) = Antenna Factor(dB/m) + Cable Factor(dB) – Pre-Amplifier Factor(dB)
3. Margin value = Emission Level – Limit value
4. The other emission levels were very low against the limit.
5. " * " : Fundamental frequency.
6. " # " : The radiated frequency is out of the restricted band.

RF Mode	TX 802.11n (HT20)	Channel	CH 40 : 5200 MHz
Frequency Range	1GHz ~ 40GHz	Detector Function	Peak (PK) Average (AV)

Antenna Polarity & Test Distance : Horizontal at 3 m

No	Frequency (MHz)	Emission Level (dBuV/m)	Limit (dBuV/m)	Margin (dB)	Antenna Height (m)	Table Angle (Degree)	Raw Value (dBuV)	Correction Factor (dB/m)
1	*5200.00	116.9 PK			2.24 H	11	80.5	36.4
2	*5200.00	106.4 AV			2.24 H	11	70.0	36.4
3	#10400.00	57.7 PK	68.2	-10.5	1.02 H	22	42.5	15.2

Antenna Polarity & Test Distance : Vertical at 3 m

No	Frequency (MHz)	Emission Level (dBuV/m)	Limit (dBuV/m)	Margin (dB)	Antenna Height (m)	Table Angle (Degree)	Raw Value (dBuV)	Correction Factor (dB/m)
1	*5200.00	104.7 PK			1.24 V	29	68.3	36.4
2	*5200.00	94.2 AV			1.24 V	29	57.8	36.4
3	#10400.00	62.5 PK	68.2	-5.7	1.06 V	76	47.3	15.2

Remarks:

1. Emission Level(dBuV/m) = Raw Value(dBuV) + Correction Factor(dB/m)
2. Correction Factor(dB/m) = Antenna Factor(dB/m) + Cable Factor(dB) – Pre-Amplifier Factor(dB)
3. Margin value = Emission Level – Limit value
4. The other emission levels were very low against the limit.
5. " * ": Fundamental frequency.
6. " # ": The radiated frequency is out of the restricted band.

RF Mode	TX 802.11n (HT20)	Channel	CH 48 : 5240 MHz
Frequency Range	1GHz ~ 40GHz	Detector Function	Peak (PK) Average (AV)

Antenna Polarity & Test Distance : Horizontal at 3 m

No	Frequency (MHz)	Emission Level (dBuV/m)	Limit (dBuV/m)	Margin (dB)	Antenna Height (m)	Table Angle (Degree)	Raw Value (dBuV)	Correction Factor (dB/m)
1	*5240.00	117.4 PK			2.12 H	14	81.1	36.3
2	*5240.00	106.9 AV			2.12 H	14	70.6	36.3
3	5350.00	51.2 PK	74.0	-22.8	2.12 H	14	49.2	2.0
4	5350.00	39.1 AV	54.0	-14.9	2.12 H	14	37.1	2.0
5	#10480.00	58.1 PK	68.2	-10.1	1.44 H	5	43.0	15.1

Antenna Polarity & Test Distance : Vertical at 3 m

No	Frequency (MHz)	Emission Level (dBuV/m)	Limit (dBuV/m)	Margin (dB)	Antenna Height (m)	Table Angle (Degree)	Raw Value (dBuV)	Correction Factor (dB/m)
1	*5240.00	104.8 PK			1.36 V	28	68.5	36.3
2	*5240.00	94.5 AV			1.36 V	28	58.2	36.3
3	5350.00	49.2 PK	74.0	-24.8	1.36 V	28	47.2	2.0
4	5350.00	38.0 AV	54.0	-16.0	1.36 V	28	36.0	2.0
5	#10480.00	63.2 PK	68.2	-5.0	1.23 V	69	48.1	15.1

Remarks:

1. Emission Level(dBuV/m) = Raw Value(dBuV) + Correction Factor(dB/m)
2. Correction Factor(dB/m) = Antenna Factor(dB/m) + Cable Factor(dB) – Pre-Amplifier Factor(dB)
3. Margin value = Emission Level – Limit value
4. The other emission levels were very low against the limit.
5. " * " : Fundamental frequency.
6. " # " : The radiated frequency is out of the restricted band.

RF Mode	TX 802.11n (HT20)	Channel	CH 52 : 5260 MHz
Frequency Range	1GHz ~ 40GHz	Detector Function	Peak (PK) Average (AV)

Antenna Polarity & Test Distance : Horizontal at 3 m

No	Frequency (MHz)	Emission Level (dBuV/m)	Limit (dBuV/m)	Margin (dB)	Antenna Height (m)	Table Angle (Degree)	Raw Value (dBuV)	Correction Factor (dB/m)
1	5150.00	58.8 PK	74.0	-15.2	1.52 H	9	56.6	2.2
2	5150.00	40.0 AV	54.0	-14.0	1.52 H	9	37.8	2.2
3	*5260.00	117.6 PK			1.52 H	9	81.4	36.2
4	*5260.00	108.5 AV			1.52 H	9	72.3	36.2
5	#10520.00	56.3 PK	68.2	-11.9	1.18 H	75	41.1	15.2

Antenna Polarity & Test Distance : Vertical at 3 m

No	Frequency (MHz)	Emission Level (dBuV/m)	Limit (dBuV/m)	Margin (dB)	Antenna Height (m)	Table Angle (Degree)	Raw Value (dBuV)	Correction Factor (dB/m)
1	*5260.00	104.0 PK			1.77 V	30	67.8	36.2
2	*5260.00	96.3 AV			1.77 V	30	60.1	36.2
3	5350.00	52.0 PK	74.0	-22.0	1.77 V	30	50.0	2.0
4	5350.00	38.5 AV	54.0	-15.5	1.77 V	30	36.5	2.0
5	#10520.00	63.8 PK	68.2	-4.4	1.06 V	79	48.6	15.2

Remarks:

1. Emission Level(dBuV/m) = Raw Value(dBuV) + Correction Factor(dB/m)
2. Correction Factor(dB/m) = Antenna Factor(dB/m) + Cable Factor(dB) – Pre-Amplifier Factor(dB)
3. Margin value = Emission Level – Limit value
4. The other emission levels were very low against the limit.
5. " * " : Fundamental frequency.
6. " # " : The radiated frequency is out of the restricted band.

RF Mode	TX 802.11n (HT20)	Channel	CH 60 : 5300 MHz
Frequency Range	1GHz ~ 40GHz	Detector Function	Peak (PK) Average (AV)

Antenna Polarity & Test Distance : Horizontal at 3 m

No	Frequency (MHz)	Emission Level (dBuV/m)	Limit (dBuV/m)	Margin (dB)	Antenna Height (m)	Table Angle (Degree)	Raw Value (dBuV)	Correction Factor (dB/m)
1	*5300.00	116.4 PK			1.86 H	10	80.4	36.0
2	*5300.00	107.8 AV			1.86 H	10	71.8	36.0
3	10600.00	56.6 PK	74.0	-17.4	1.49 H	86	40.9	15.7
4	10600.00	45.3 AV	54.0	-8.7	1.49 H	86	29.6	15.7

Antenna Polarity & Test Distance : Vertical at 3 m

No	Frequency (MHz)	Emission Level (dBuV/m)	Limit (dBuV/m)	Margin (dB)	Antenna Height (m)	Table Angle (Degree)	Raw Value (dBuV)	Correction Factor (dB/m)
1	*5300.00	105.3 PK			1.21 V	28	69.3	36.0
2	*5300.00	96.4 AV			1.21 V	28	60.4	36.0
3	10600.00	63.7 PK	74.0	-10.3	1.08 V	77	48.0	15.7
4	10600.00	52.4 AV	54.0	-1.6	1.08 V	77	36.7	15.7

Remarks:

1. Emission Level(dBuV/m) = Raw Value(dBuV) + Correction Factor(dB/m)
2. Correction Factor(dB/m) = Antenna Factor(dB/m) + Cable Factor(dB) – Pre-Amplifier Factor(dB)
3. Margin value = Emission Level – Limit value
4. The other emission levels were very low against the limit.
5. " * " : Fundamental frequency.

RF Mode	TX 802.11n (HT20)	Channel	CH 64 : 5320 MHz
Frequency Range	1GHz ~ 40GHz	Detector Function	Peak (PK) Average (AV)

Antenna Polarity & Test Distance : Horizontal at 3 m

No	Frequency (MHz)	Emission Level (dBuV/m)	Limit (dBuV/m)	Margin (dB)	Antenna Height (m)	Table Angle (Degree)	Raw Value (dBuV)	Correction Factor (dB/m)
1	*5320.00	115.2 PK			1.74 H	11	79.0	36.2
2	*5320.00	106.6 AV			1.74 H	11	70.4	36.2
3	5350.00	69.4 PK	74.0	-4.6	1.74 H	11	67.4	2.0
4	5350.00	53.9 AV	54.0	-0.1	1.74 H	11	51.9	2.0
5	10640.00	56.7 PK	74.0	-17.3	1.28 H	74	40.9	15.8
6	10640.00	45.8 AV	54.0	-8.2	1.28 H	74	30.0	15.8

Antenna Polarity & Test Distance : Vertical at 3 m

No	Frequency (MHz)	Emission Level (dBuV/m)	Limit (dBuV/m)	Margin (dB)	Antenna Height (m)	Table Angle (Degree)	Raw Value (dBuV)	Correction Factor (dB/m)
1	*5320.00	105.9 PK			1.78 V	31	69.7	36.2
2	*5320.00	97.5 AV			1.78 V	31	61.3	36.2
3	5350.00	65.5 PK	74.0	-8.5	1.78 V	31	63.5	2.0
4	5350.00	48.7 AV	54.0	-5.3	1.78 V	31	46.7	2.0
5	10640.00	60.9 PK	74.0	-13.1	1.04 V	75	45.1	15.8
6	10640.00	50.4 AV	54.0	-3.6	1.04 V	75	34.6	15.8

Remarks:

1. Emission Level(dBuV/m) = Raw Value(dBuV) + Correction Factor(dB/m)
2. Correction Factor(dB/m) = Antenna Factor(dB/m) + Cable Factor(dB) – Pre-Amplifier Factor(dB)
3. Margin value = Emission Level – Limit value
4. The other emission levels were very low against the limit.
5. " * ": Fundamental frequency.

RF Mode	TX 802.11n (HT20)	Channel	CH 100 : 5500 MHz
Frequency Range	1GHz ~ 40GHz	Detector Function	Peak (PK) Average (AV)

Antenna Polarity & Test Distance : Horizontal at 3 m

No	Frequency (MHz)	Emission Level (dBuV/m)	Limit (dBuV/m)	Margin (dB)	Antenna Height (m)	Table Angle (Degree)	Raw Value (dBuV)	Correction Factor (dB/m)
1	5460.00	59.5 PK	74.0	-14.5	1.57 H	13	56.7	2.8
2	5460.00	46.1 AV	54.0	-7.9	1.57 H	13	43.3	2.8
3	#5470.00	67.1 PK	68.2	-1.1	1.57 H	13	64.3	2.8
4	*5500.00	113.8 PK			1.57 H	13	76.8	37.0
5	*5500.00	104.8 AV			1.57 H	13	67.8	37.0
6	11000.00	55.2 PK	74.0	-18.8	1.69 H	83	38.2	17.0
7	11000.00	44.9 AV	54.0	-9.1	1.69 H	83	27.9	17.0

Antenna Polarity & Test Distance : Vertical at 3 m

No	Frequency (MHz)	Emission Level (dBuV/m)	Limit (dBuV/m)	Margin (dB)	Antenna Height (m)	Table Angle (Degree)	Raw Value (dBuV)	Correction Factor (dB/m)
1	5460.00	58.2 PK	74.0	-15.8	2.56 V	30	54.8	3.4
2	5460.00	44.8 AV	54.0	-9.2	2.56 V	30	41.4	3.4
3	#5470.00	64.1 PK	68.2	-4.1	2.56 V	30	60.7	3.4
4	*5500.00	109.9 PK			2.56 V	30	72.3	37.6
5	*5500.00	101.5 AV			2.56 V	30	63.9	37.6
6	11000.00	54.5 PK	74.0	-19.5	1.24 V	55	38.0	16.5
7	11000.00	44.2 AV	54.0	-9.8	1.24 V	55	27.7	16.5

Remarks:

1. Emission Level(dBuV/m) = Raw Value(dBuV) + Correction Factor(dB/m)
2. Correction Factor(dB/m) = Antenna Factor(dB/m) + Cable Factor(dB) – Pre-Amplifier Factor(dB)
3. Margin value = Emission Level – Limit value
4. The other emission levels were very low against the limit.
5. " * ": Fundamental frequency.
6. " # ": The radiated frequency is out of the restricted band.

RF Mode	TX 802.11n (HT20)	Channel	CH 116 : 5580 MHz
Frequency Range	1GHz ~ 40GHz	Detector Function	Peak (PK) Average (AV)

Antenna Polarity & Test Distance : Horizontal at 3 m

No	Frequency (MHz)	Emission Level (dBuV/m)	Limit (dBuV/m)	Margin (dB)	Antenna Height (m)	Table Angle (Degree)	Raw Value (dBuV)	Correction Factor (dB/m)
1	*5580.00	116.0 PK			1.69 H	17	79.0	37.0
2	*5580.00	107.1 AV			1.69 H	17	70.1	37.0
3	11160.00	54.6 PK	74.0	-19.4	1.45 H	94	38.6	16.0
4	11160.00	43.3 AV	54.0	-10.7	1.45 H	94	27.3	16.0

Antenna Polarity & Test Distance : Vertical at 3 m

No	Frequency (MHz)	Emission Level (dBuV/m)	Limit (dBuV/m)	Margin (dB)	Antenna Height (m)	Table Angle (Degree)	Raw Value (dBuV)	Correction Factor (dB/m)
1	*5580.00	105.5 PK			1.62 V	35	68.0	37.5
2	*5580.00	96.9 AV			1.62 V	35	59.4	37.5
3	11160.00	54.8 PK	74.0	-19.2	1.12 V	48	38.2	16.6
4	11160.00	44.0 AV	54.0	-10.0	1.12 V	48	27.4	16.6

Remarks:

1. Emission Level(dBuV/m) = Raw Value(dBuV) + Correction Factor(dB/m)
2. Correction Factor(dB/m) = Antenna Factor(dB/m) + Cable Factor(dB) – Pre-Amplifier Factor(dB)
3. Margin value = Emission Level – Limit value
4. The other emission levels were very low against the limit.
5. " * " : Fundamental frequency.

RF Mode	TX 802.11n (HT20)	Channel	CH 140 : 5700 MHz
Frequency Range	1GHz ~ 40GHz	Detector Function	Peak (PK) Average (AV)

Antenna Polarity & Test Distance : Horizontal at 3 m

No	Frequency (MHz)	Emission Level (dBuV/m)	Limit (dBuV/m)	Margin (dB)	Antenna Height (m)	Table Angle (Degree)	Raw Value (dBuV)	Correction Factor (dB/m)
1	*5700.00	112.8 PK			1.69 H	12	75.6	37.2
2	*5700.00	104.5 AV			1.69 H	12	67.3	37.2
3	#5725.00	64.7 PK	68.2	-3.5	1.69 H	12	61.7	3.0
4	11400.00	54.8 PK	74.0	-19.2	1.52 H	91	38.5	16.3
5	11400.00	43.7 AV	54.0	-10.3	1.52 H	91	27.4	16.3

Antenna Polarity & Test Distance : Vertical at 3 m

No	Frequency (MHz)	Emission Level (dBuV/m)	Limit (dBuV/m)	Margin (dB)	Antenna Height (m)	Table Angle (Degree)	Raw Value (dBuV)	Correction Factor (dB/m)
1	*5700.00	106.4 PK			1.84 V	31	68.7	37.7
2	*5700.00	97.5 AV			1.84 V	31	59.8	37.7
3	#5725.00	64.5 PK	68.2	-3.7	1.84 V	31	61.0	3.5
4	11400.00	54.3 PK	74.0	-19.7	1.05 V	43	38.3	16.0
5	11400.00	43.2 AV	54.0	-10.8	1.05 V	43	27.2	16.0

Remarks:

1. Emission Level(dBuV/m) = Raw Value(dBuV) + Correction Factor(dB/m)
2. Correction Factor(dB/m) = Antenna Factor(dB/m) + Cable Factor(dB) – Pre-Amplifier Factor(dB)
3. Margin value = Emission Level – Limit value
4. The other emission levels were very low against the limit.
5. " * ": Fundamental frequency.
6. " # ": The radiated frequency is out of the restricted band.

RF Mode	TX 802.11n (HT20)	Channel	CH 144 : 5720 MHz
Frequency Range	1GHz ~ 40GHz	Detector Function	Peak (PK) Average (AV)

Antenna Polarity & Test Distance : Horizontal at 3 m

No	Frequency (MHz)	Emission Level (dBuV/m)	Limit (dBuV/m)	Margin (dB)	Antenna Height (m)	Table Angle (Degree)	Raw Value (dBuV)	Correction Factor (dB/m)
1	*5720.00	114.2 PK			1.64 H	16	76.9	37.3
2	*5720.00	105.4 AV			1.64 H	16	68.1	37.3
3	#5850.00	55.4 PK	68.2	-12.8	1.64 H	16	51.9	3.5
4	11440.00	54.2 PK	74.0	-19.8	1.46 H	89	38.2	16.0
5	11440.00	43.5 AV	54.0	-10.5	1.46 H	89	27.5	16.0

Antenna Polarity & Test Distance : Vertical at 3 m

No	Frequency (MHz)	Emission Level (dBuV/m)	Limit (dBuV/m)	Margin (dB)	Antenna Height (m)	Table Angle (Degree)	Raw Value (dBuV)	Correction Factor (dB/m)
1	*5720.00	109.5 PK			2.28 V	32	71.7	37.8
2	*5720.00	100.6 AV			2.28 V	32	62.8	37.8
3	#5850.00	52.9 PK	68.2	-15.3	2.28 V	32	48.8	4.1
4	11440.00	54.2 PK	74.0	-19.8	1.06 V	43	38.2	16.0
5	11440.00	43.5 AV	54.0	-10.5	1.06 V	43	27.5	16.0

Remarks:

1. Emission Level(dBuV/m) = Raw Value(dBuV) + Correction Factor(dB/m)
2. Correction Factor(dB/m) = Antenna Factor(dB/m) + Cable Factor(dB) – Pre-Amplifier Factor(dB)
3. Margin value = Emission Level – Limit value
4. The other emission levels were very low against the limit.
5. " * " : Fundamental frequency.
6. " # " : The radiated frequency is out of the restricted band.

RF Mode	TX 802.11n (HT20)	Channel	CH 149 : 5745 MHz
Frequency Range	1GHz ~ 40GHz	Detector Function	Peak (PK) Average (AV)

Antenna Polarity & Test Distance : Horizontal at 3 m

No	Frequency (MHz)	Emission Level (dBuV/m)	Limit (dBuV/m)	Margin (dB)	Antenna Height (m)	Table Angle (Degree)	Raw Value (dBuV)	Correction Factor (dB/m)
1	#5645.60	53.7 PK	68.2	-14.5	1.74 H	16	50.9	2.8
2	*5745.00	117.0 PK			1.74 H	16	79.7	37.3
3	*5745.00	107.0 AV			1.74 H	16	69.7	37.3
4	#5970.00	53.4 PK	68.2	-14.8	1.74 H	16	50.0	3.4
5	11490.00	57.4 PK	74.0	-16.6	1.07 H	27	41.6	15.8
6	11490.00	44.3 AV	54.0	-9.7	1.07 H	27	28.5	15.8

Antenna Polarity & Test Distance : Vertical at 3 m

No	Frequency (MHz)	Emission Level (dBuV/m)	Limit (dBuV/m)	Margin (dB)	Antenna Height (m)	Table Angle (Degree)	Raw Value (dBuV)	Correction Factor (dB/m)
1	#5642.40	52.6 PK	68.2	-15.6	1.04 V	34	49.8	2.8
2	*5745.00	108.1 PK			1.04 V	34	70.8	37.3
3	*5745.00	98.2 AV			1.04 V	34	60.9	37.3
4	#5959.20	53.5 PK	68.2	-14.7	1.04 V	34	50.0	3.5
5	11490.00	58.2 PK	74.0	-15.8	1.02 V	58	42.4	15.8
6	11490.00	44.5 AV	54.0	-9.5	1.02 V	58	28.7	15.8

Remarks:

1. Emission Level(dBuV/m) = Raw Value(dBuV) + Correction Factor(dB/m)
2. Correction Factor(dB/m) = Antenna Factor(dB/m) + Cable Factor(dB) – Pre-Amplifier Factor(dB)
3. Margin value = Emission Level – Limit value
4. The other emission levels were very low against the limit.
5. " * " : Fundamental frequency.
6. " # " : The radiated frequency is out of the restricted band.

RF Mode	TX 802.11n (HT20)	Channel	CH 157 : 5785 MHz
Frequency Range	1GHz ~ 40GHz	Detector Function	Peak (PK) Average (AV)

Antenna Polarity & Test Distance : Horizontal at 3 m

No	Frequency (MHz)	Emission Level (dBuV/m)	Limit (dBuV/m)	Margin (dB)	Antenna Height (m)	Table Angle (Degree)	Raw Value (dBuV)	Correction Factor (dB/m)
1	#5621.20	54.3 PK	68.2	-13.9	1.93 H	18	51.6	2.7
2	*5785.00	116.1 PK			1.93 H	18	78.6	37.5
3	*5785.00	106.1 AV			1.93 H	18	68.6	37.5
4	#5955.20	53.4 PK	68.2	-14.8	1.93 H	18	49.9	3.5
5	11570.00	57.0 PK	74.0	-17.0	1.11 H	32	41.6	15.4
6	11570.00	43.9 AV	54.0	-10.1	1.11 H	32	28.5	15.4

Antenna Polarity & Test Distance : Vertical at 3 m

No	Frequency (MHz)	Emission Level (dBuV/m)	Limit (dBuV/m)	Margin (dB)	Antenna Height (m)	Table Angle (Degree)	Raw Value (dBuV)	Correction Factor (dB/m)
1	#5627.60	52.6 PK	68.2	-15.6	1.02 V	37	49.9	2.7
2	*5785.00	107.3 PK			1.02 V	37	69.8	37.5
3	*5785.00	97.3 AV			1.02 V	37	59.8	37.5
4	#5963.20	53.4 PK	68.2	-14.8	1.02 V	37	49.9	3.5
5	11570.00	57.7 PK	74.0	-16.3	1.08 V	62	42.3	15.4
6	11570.00	44.1 AV	54.0	-9.9	1.08 V	62	28.7	15.4

Remarks:

1. Emission Level(dBuV/m) = Raw Value(dBuV) + Correction Factor(dB/m)
2. Correction Factor(dB/m) = Antenna Factor(dB/m) + Cable Factor(dB) – Pre-Amplifier Factor(dB)
3. Margin value = Emission Level – Limit value
4. The other emission levels were very low against the limit.
5. " * " : Fundamental frequency.
6. " # " : The radiated frequency is out of the restricted band.

RF Mode	TX 802.11n (HT20)	Channel	CH 165 : 5825 MHz
Frequency Range	1GHz ~ 40GHz	Detector Function	Peak (PK) Average (AV)

Antenna Polarity & Test Distance : Horizontal at 3 m

No	Frequency (MHz)	Emission Level (dBuV/m)	Limit (dBuV/m)	Margin (dB)	Antenna Height (m)	Table Angle (Degree)	Raw Value (dBuV)	Correction Factor (dB/m)
1	#5636.00	52.6 PK	68.2	-15.6	1.91 H	17	49.9	2.7
2	*5825.00	115.1 PK			1.91 H	17	77.5	37.6
3	*5825.00	105.2 AV			1.91 H	17	67.6	37.6
4	#5939.20	53.3 PK	68.2	-14.9	1.91 H	17	49.8	3.5
5	11650.00	56.9 PK	74.0	-17.1	1.13 H	24	41.4	15.5
6	11650.00	43.8 AV	54.0	-10.2	1.13 H	24	28.3	15.5

Antenna Polarity & Test Distance : Vertical at 3 m

No	Frequency (MHz)	Emission Level (dBuV/m)	Limit (dBuV/m)	Margin (dB)	Antenna Height (m)	Table Angle (Degree)	Raw Value (dBuV)	Correction Factor (dB/m)
1	#5615.60	53.3 PK	68.2	-14.9	1.12 V	45	50.6	2.7
2	*5825.00	106.5 PK			1.12 V	45	68.9	37.6
3	*5825.00	96.5 AV			1.12 V	45	58.9	37.6
4	#5960.00	53.2 PK	68.2	-15.0	1.12 V	45	49.7	3.5
5	11650.00	57.7 PK	74.0	-16.3	1.01 V	53	42.2	15.5
6	11650.00	44.3 AV	54.0	-9.7	1.01 V	53	28.8	15.5

Remarks:

1. Emission Level(dBuV/m) = Raw Value(dBuV) + Correction Factor(dB/m)
2. Correction Factor(dB/m) = Antenna Factor(dB/m) + Cable Factor(dB) – Pre-Amplifier Factor(dB)
3. Margin value = Emission Level – Limit value
4. The other emission levels were very low against the limit.
5. " * " : Fundamental frequency.
6. " # " : The radiated frequency is out of the restricted band.

RF Mode	TX 802.11n (HT40)	Channel	CH 38 : 5190 MHz
Frequency Range	1GHz ~ 40GHz	Detector Function	Peak (PK) Average (AV)

Antenna Polarity & Test Distance : Horizontal at 3 m

No	Frequency (MHz)	Emission Level (dBuV/m)	Limit (dBuV/m)	Margin (dB)	Antenna Height (m)	Table Angle (Degree)	Raw Value (dBuV)	Correction Factor (dB/m)
1	5150.00	63.0 PK	74.0	-11.0	2.12 H	13	60.8	2.2
2	5150.00	53.1 AV	54.0	-0.9	2.12 H	13	50.9	2.2
3	*5190.00	109.2 PK			2.12 H	13	72.8	36.4
4	*5190.00	100.1 AV			2.12 H	13	63.7	36.4
5	#10380.00	55.9 PK	68.2	-12.3	1.13 H	22	40.7	15.2

Antenna Polarity & Test Distance : Vertical at 3 m

No	Frequency (MHz)	Emission Level (dBuV/m)	Limit (dBuV/m)	Margin (dB)	Antenna Height (m)	Table Angle (Degree)	Raw Value (dBuV)	Correction Factor (dB/m)
1	5150.00	51.6 PK	74.0	-22.4	1.11 V	30	49.4	2.2
2	5150.00	42.5 AV	54.0	-11.5	1.11 V	30	40.3	2.2
3	*5190.00	96.4 PK			1.11 V	30	60.0	36.4
4	*5190.00	87.1 AV			1.11 V	30	50.7	36.4
5	#10380.00	58.6 PK	68.2	-9.6	1.26 V	68	43.4	15.2

Remarks:

1. Emission Level(dBuV/m) = Raw Value(dBuV) + Correction Factor(dB/m)
2. Correction Factor(dB/m) = Antenna Factor(dB/m) + Cable Factor(dB) – Pre-Amplifier Factor(dB)
3. Margin value = Emission Level – Limit value
4. The other emission levels were very low against the limit.
5. " * " : Fundamental frequency.
6. " # " : The radiated frequency is out of the restricted band.

RF Mode	TX 802.11n (HT40)	Channel	CH 46 : 5230 MHz
Frequency Range	1GHz ~ 40GHz	Detector Function	Peak (PK) Average (AV)

Antenna Polarity & Test Distance : Horizontal at 3 m

No	Frequency (MHz)	Emission Level (dBuV/m)	Limit (dBuV/m)	Margin (dB)	Antenna Height (m)	Table Angle (Degree)	Raw Value (dBuV)	Correction Factor (dB/m)
1	*5230.00	113.7 PK			1.91 H	13	77.4	36.3
2	*5230.00	104.5 AV			1.91 H	13	68.2	36.3
3	5350.00	53.8 PK	74.0	-20.2	1.91 H	13	51.8	2.0
4	5350.00	39.8 AV	54.0	-14.2	1.91 H	13	37.8	2.0
5	#10460.00	57.4 PK	68.2	-10.8	1.16 H	19	42.3	15.1

Antenna Polarity & Test Distance : Vertical at 3 m

No	Frequency (MHz)	Emission Level (dBuV/m)	Limit (dBuV/m)	Margin (dB)	Antenna Height (m)	Table Angle (Degree)	Raw Value (dBuV)	Correction Factor (dB/m)
1	*5230.00	101.9 PK			1.38 V	33	65.6	36.3
2	*5230.00	92.8 AV			1.38 V	33	56.5	36.3
3	5350.00	50.8 PK	74.0	-23.2	1.38 V	33	48.8	2.0
4	5350.00	38.2 AV	54.0	-15.8	1.38 V	33	36.2	2.0
5	#10460.00	59.5 PK	68.2	-8.7	1.04 V	79	44.4	15.1

Remarks:

1. Emission Level(dBuV/m) = Raw Value(dBuV) + Correction Factor(dB/m)
2. Correction Factor(dB/m) = Antenna Factor(dB/m) + Cable Factor(dB) – Pre-Amplifier Factor(dB)
3. Margin value = Emission Level – Limit value
4. The other emission levels were very low against the limit.
5. " * " : Fundamental frequency.
6. " # " : The radiated frequency is out of the restricted band.

RF Mode	TX 802.11n (HT40)	Channel	CH 54 : 5270 MHz
Frequency Range	1GHz ~ 40GHz	Detector Function	Peak (PK) Average (AV)

Antenna Polarity & Test Distance : Horizontal at 3 m

No	Frequency (MHz)	Emission Level (dBuV/m)	Limit (dBuV/m)	Margin (dB)	Antenna Height (m)	Table Angle (Degree)	Raw Value (dBuV)	Correction Factor (dB/m)
1	*5270.00	114.1 PK			1.81 H	9	77.9	36.2
2	*5270.00	105.7 AV			1.81 H	9	69.5	36.2
3	5350.00	63.6 PK	74.0	-10.4	1.81 H	9	61.6	2.0
4	5350.00	46.4 AV	54.0	-7.6	1.81 H	9	44.4	2.0
5	#10540.00	58.3 PK	68.2	-9.9	1.15 H	67	42.9	15.4

Antenna Polarity & Test Distance : Vertical at 3 m

No	Frequency (MHz)	Emission Level (dBuV/m)	Limit (dBuV/m)	Margin (dB)	Antenna Height (m)	Table Angle (Degree)	Raw Value (dBuV)	Correction Factor (dB/m)
1	*5270.00	102.4 PK			1.34 V	30	66.2	36.2
2	*5270.00	93.7 AV			1.34 V	30	57.5	36.2
3	5350.00	55.5 PK	74.0	-18.5	1.34 V	30	53.5	2.0
4	5350.00	41.1 AV	54.0	-12.9	1.34 V	30	39.1	2.0
5	#10540.00	63.6 PK	68.2	-4.6	1.11 V	76	48.2	15.4

Remarks:

1. Emission Level(dBuV/m) = Raw Value(dBuV) + Correction Factor(dB/m)
2. Correction Factor(dB/m) = Antenna Factor(dB/m) + Cable Factor(dB) – Pre-Amplifier Factor(dB)
3. Margin value = Emission Level – Limit value
4. The other emission levels were very low against the limit.
5. " * " : Fundamental frequency.
6. " # " : The radiated frequency is out of the restricted band.

RF Mode	TX 802.11n (HT40)	Channel	CH 62 : 5310 MHz
Frequency Range	1GHz ~ 40GHz	Detector Function	Peak (PK) Average (AV)

Antenna Polarity & Test Distance : Horizontal at 3 m

No	Frequency (MHz)	Emission Level (dBuV/m)	Limit (dBuV/m)	Margin (dB)	Antenna Height (m)	Table Angle (Degree)	Raw Value (dBuV)	Correction Factor (dB/m)
1	*5310.00	109.3 PK			1.84 H	12	73.2	36.1
2	*5310.00	101.5 AV			1.84 H	12	65.4	36.1
3	5350.00	67.2 PK	74.0	-6.8	1.84 H	12	65.2	2.0
4	5350.00	52.9 AV	54.0	-1.1	1.84 H	12	50.9	2.0
5	10620.00	54.9 PK	74.0	-19.1	1.09 H	84	39.2	15.7
6	10620.00	44.3 AV	54.0	-9.7	1.09 H	84	28.6	15.7

Antenna Polarity & Test Distance : Vertical at 3 m

No	Frequency (MHz)	Emission Level (dBuV/m)	Limit (dBuV/m)	Margin (dB)	Antenna Height (m)	Table Angle (Degree)	Raw Value (dBuV)	Correction Factor (dB/m)
1	*5310.00	99.4 PK			1.82 V	30	63.3	36.1
2	*5310.00	91.1 AV			1.82 V	30	55.0	36.1
3	5350.00	60.6 PK	74.0	-13.4	1.82 V	30	58.6	2.0
4	5350.00	45.3 AV	54.0	-8.7	1.82 V	30	43.3	2.0
5	10620.00	57.6 PK	74.0	-16.4	1.18 V	77	41.9	15.7
6	10620.00	46.5 AV	54.0	-7.5	1.18 V	77	30.8	15.7

Remarks:

1. Emission Level(dBuV/m) = Raw Value(dBuV) + Correction Factor(dB/m)
2. Correction Factor(dB/m) = Antenna Factor(dB/m) + Cable Factor(dB) – Pre-Amplifier Factor(dB)
3. Margin value = Emission Level – Limit value
4. The other emission levels were very low against the limit.
5. " * ": Fundamental frequency.

RF Mode	TX 802.11n (HT40)	Channel	CH 102 : 5510 MHz
Frequency Range	1GHz ~ 40GHz	Detector Function	Peak (PK) Average (AV)

Antenna Polarity & Test Distance : Horizontal at 3 m

No	Frequency (MHz)	Emission Level (dBuV/m)	Limit (dBuV/m)	Margin (dB)	Antenna Height (m)	Table Angle (Degree)	Raw Value (dBuV)	Correction Factor (dB/m)
1	5460.00	61.3 PK	74.0	-12.7	1.47 H	13	58.5	2.8
2	5460.00	50.3 AV	54.0	-3.7	1.47 H	13	47.5	2.8
3	#5470.00	67.3 PK	68.2	-0.9	1.47 H	13	64.5	2.8
4	*5510.00	108.3 PK			1.47 H	13	71.3	37.0
5	*5510.00	99.4 AV			1.47 H	13	62.4	37.0
6	11020.00	55.3 PK	74.0	-18.7	1.42 H	93	38.4	16.9
7	11020.00	44.1 AV	54.0	-9.9	1.42 H	93	27.2	16.9

Antenna Polarity & Test Distance : Vertical at 3 m

No	Frequency (MHz)	Emission Level (dBuV/m)	Limit (dBuV/m)	Margin (dB)	Antenna Height (m)	Table Angle (Degree)	Raw Value (dBuV)	Correction Factor (dB/m)
1	5460.00	56.6 PK	74.0	-17.4	2.44 V	29	53.2	3.4
2	5460.00	44.8 AV	54.0	-9.2	2.44 V	29	41.4	3.4
3	#5470.00	62.9 PK	68.2	-5.3	2.44 V	29	59.5	3.4
4	*5510.00	103.2 PK			2.44 V	29	65.6	37.6
5	*5510.00	94.7 AV			2.44 V	29	57.1	37.6
6	11020.00	54.8 PK	74.0	-19.2	1.03 V	49	38.2	16.6
7	11020.00	44.0 AV	54.0	-10.0	1.03 V	49	27.4	16.6

Remarks:

1. Emission Level(dBuV/m) = Raw Value(dBuV) + Correction Factor(dB/m)
2. Correction Factor(dB/m) = Antenna Factor(dB/m) + Cable Factor(dB) – Pre-Amplifier Factor(dB)
3. Margin value = Emission Level – Limit value
4. The other emission levels were very low against the limit.
5. " * ": Fundamental frequency.
6. " # ": The radiated frequency is out of the restricted band.

RF Mode	TX 802.11n (HT40)	Channel	CH 110 : 5550 MHz
Frequency Range	1GHz ~ 40GHz	Detector Function	Peak (PK) Average (AV)

Antenna Polarity & Test Distance : Horizontal at 3 m

No	Frequency (MHz)	Emission Level (dBuV/m)	Limit (dBuV/m)	Margin (dB)	Antenna Height (m)	Table Angle (Degree)	Raw Value (dBuV)	Correction Factor (dB/m)
1	*5550.00	112.0 PK			1.54 H	14	75.0	37.0
2	*5550.00	104.3 AV			1.54 H	14	67.3	37.0
3	11100.00	54.6 PK	74.0	-19.4	1.40 H	90	38.5	16.1
4	11100.00	43.5 AV	54.0	-10.5	1.40 H	90	27.4	16.1

Antenna Polarity & Test Distance : Vertical at 3 m

No	Frequency (MHz)	Emission Level (dBuV/m)	Limit (dBuV/m)	Margin (dB)	Antenna Height (m)	Table Angle (Degree)	Raw Value (dBuV)	Correction Factor (dB/m)
1	*5550.00	107.4 PK			2.54 V	29	69.9	37.5
2	*5550.00	99.0 AV			2.54 V	29	61.5	37.5
3	11100.00	55.1 PK	74.0	-18.9	1.06 V	45	38.5	16.6
4	11100.00	43.9 AV	54.0	-10.1	1.06 V	45	27.3	16.6

Remarks:

1. Emission Level(dBuV/m) = Raw Value(dBuV) + Correction Factor(dB/m)
2. Correction Factor(dB/m) = Antenna Factor(dB/m) + Cable Factor(dB) – Pre-Amplifier Factor(dB)
3. Margin value = Emission Level – Limit value
4. The other emission levels were very low against the limit.
5. " * ": Fundamental frequency.

RF Mode	TX 802.11n (HT40)	Channel	CH 134 : 5670 MHz
Frequency Range	1GHz ~ 40GHz	Detector Function	Peak (PK) Average (AV)

Antenna Polarity & Test Distance : Horizontal at 3 m

No	Frequency (MHz)	Emission Level (dBuV/m)	Limit (dBuV/m)	Margin (dB)	Antenna Height (m)	Table Angle (Degree)	Raw Value (dBuV)	Correction Factor (dB/m)
1	*5670.00	112.5 PK			1.66 H	10	75.3	37.2
2	*5670.00	104.3 AV			1.66 H	10	67.1	37.2
3	#5725.00	67.5 PK	68.2	-0.7	1.66 H	10	64.5	3.0
4	11340.00	54.4 PK	74.0	-19.6	1.44 H	94	37.9	16.5
5	11340.00	43.9 AV	54.0	-10.1	1.44 H	94	27.4	16.5

Antenna Polarity & Test Distance : Vertical at 3 m

No	Frequency (MHz)	Emission Level (dBuV/m)	Limit (dBuV/m)	Margin (dB)	Antenna Height (m)	Table Angle (Degree)	Raw Value (dBuV)	Correction Factor (dB/m)
1	*5670.00	107.9 PK			2.32 V	32	70.4	37.5
2	*5670.00	99.4 AV			2.32 V	32	61.9	37.5
3	#5725.00	64.4 PK	68.2	-3.8	2.32 V	32	60.9	3.5
4	11340.00	54.1 PK	74.0	-19.9	1.10 V	48	38.0	16.1
5	11340.00	43.2 AV	54.0	-10.8	1.10 V	48	27.1	16.1

Remarks:

1. Emission Level(dBuV/m) = Raw Value(dBuV) + Correction Factor(dB/m)
2. Correction Factor(dB/m) = Antenna Factor(dB/m) + Cable Factor(dB) – Pre-Amplifier Factor(dB)
3. Margin value = Emission Level – Limit value
4. The other emission levels were very low against the limit.
5. " * ": Fundamental frequency.
6. " # ": The radiated frequency is out of the restricted band.

RF Mode	TX 802.11n (HT40)	Channel	CH 142 : 5710 MHz
Frequency Range	1GHz ~ 40GHz	Detector Function	Peak (PK) Average (AV)

Antenna Polarity & Test Distance : Horizontal at 3 m

No	Frequency (MHz)	Emission Level (dBuV/m)	Limit (dBuV/m)	Margin (dB)	Antenna Height (m)	Table Angle (Degree)	Raw Value (dBuV)	Correction Factor (dB/m)
1	*5710.00	110.9 PK			1.84 H	19	73.7	37.2
2	*5710.00	102.9 AV			1.84 H	19	65.7	37.2
3	#5850.00	44.1 PK	68.2	-24.1	1.84 H	19	40.6	3.5
4	11420.00	54.4 PK	74.0	-19.6	1.39 H	96	38.2	16.2
5	11420.00	43.6 AV	54.0	-10.4	1.39 H	96	27.4	16.2

Antenna Polarity & Test Distance : Vertical at 3 m

No	Frequency (MHz)	Emission Level (dBuV/m)	Limit (dBuV/m)	Margin (dB)	Antenna Height (m)	Table Angle (Degree)	Raw Value (dBuV)	Correction Factor (dB/m)
1	*5710.00	108.4 PK			2.33 V	32	70.7	37.7
2	*5710.00	99.3 AV			2.33 V	32	61.6	37.7
3	#5850.00	53.9 PK	68.2	-14.3	2.33 V	32	49.8	4.1
4	11420.00	54.4 PK	74.0	-19.6	1.05 V	47	38.3	16.1
5	11420.00	43.5 AV	54.0	-10.5	1.05 V	47	27.4	16.1

Remarks:

1. Emission Level(dBuV/m) = Raw Value(dBuV) + Correction Factor(dB/m)
2. Correction Factor(dB/m) = Antenna Factor(dB/m) + Cable Factor(dB) – Pre-Amplifier Factor(dB)
3. Margin value = Emission Level – Limit value
4. The other emission levels were very low against the limit.
5. " * " : Fundamental frequency.
6. " # " : The radiated frequency is out of the restricted band.

RF Mode	TX 802.11n (HT40)	Channel	CH 151 : 5755 MHz
Frequency Range	1GHz ~ 40GHz	Detector Function	Peak (PK) Average (AV)

Antenna Polarity & Test Distance : Horizontal at 3 m

No	Frequency (MHz)	Emission Level (dBuV/m)	Limit (dBuV/m)	Margin (dB)	Antenna Height (m)	Table Angle (Degree)	Raw Value (dBuV)	Correction Factor (dB/m)
1	#5646.00	58.1 PK	68.2	-10.1	1.71 H	14	55.3	2.8
2	*5755.00	113.7 PK			1.71 H	14	76.4	37.3
3	*5755.00	104.0 AV			1.71 H	14	66.7	37.3
4	#5986.80	53.5 PK	68.2	-14.7	1.71 H	14	50.1	3.4
5	11510.00	56.4 PK	74.0	-17.6	1.15 H	32	40.8	15.6
6	11510.00	43.5 AV	54.0	-10.5	1.15 H	32	27.9	15.6

Antenna Polarity & Test Distance : Vertical at 3 m

No	Frequency (MHz)	Emission Level (dBuV/m)	Limit (dBuV/m)	Margin (dB)	Antenna Height (m)	Table Angle (Degree)	Raw Value (dBuV)	Correction Factor (dB/m)
1	#5609.60	53.3 PK	68.2	-14.9	1.02 V	44	50.6	2.7
2	*5755.00	105.0 PK			1.02 V	44	67.7	37.3
3	*5755.00	95.2 AV			1.02 V	44	57.9	37.3
4	#5988.80	54.0 PK	68.2	-14.2	1.02 V	44	50.6	3.4
5	11510.00	57.3 PK	74.0	-16.7	1.06 V	61	41.7	15.6
6	11510.00	43.8 AV	54.0	-10.2	1.06 V	61	28.2	15.6

Remarks:

1. Emission Level(dBuV/m) = Raw Value(dBuV) + Correction Factor(dB/m)
2. Correction Factor(dB/m) = Antenna Factor(dB/m) + Cable Factor(dB) – Pre-Amplifier Factor(dB)
3. Margin value = Emission Level – Limit value
4. The other emission levels were very low against the limit.
5. " * ": Fundamental frequency.
6. " # ": The radiated frequency is out of the restricted band.

RF Mode	TX 802.11n (HT40)	Channel	CH 159 : 5795 MHz
Frequency Range	1GHz ~ 40GHz	Detector Function	Peak (PK) Average (AV)

Antenna Polarity & Test Distance : Horizontal at 3 m

No	Frequency (MHz)	Emission Level (dBuV/m)	Limit (dBuV/m)	Margin (dB)	Antenna Height (m)	Table Angle (Degree)	Raw Value (dBuV)	Correction Factor (dB/m)
1	#5644.00	55.0 PK	68.2	-13.2	1.72 H	17	52.2	2.8
2	*5795.00	113.3 PK			1.72 H	17	75.7	37.6
3	*5795.00	103.6 AV			1.72 H	17	66.0	37.6
4	#5971.20	53.8 PK	68.2	-14.4	1.72 H	17	50.4	3.4
5	11590.00	56.1 PK	74.0	-17.9	1.13 H	25	40.7	15.4
6	11590.00	43.1 AV	54.0	-10.9	1.13 H	25	27.7	15.4

Antenna Polarity & Test Distance : Vertical at 3 m

No	Frequency (MHz)	Emission Level (dBuV/m)	Limit (dBuV/m)	Margin (dB)	Antenna Height (m)	Table Angle (Degree)	Raw Value (dBuV)	Correction Factor (dB/m)
1	#5625.60	53.5 PK	68.2	-14.7	1.08 V	40	50.8	2.7
2	*5795.00	104.9 PK			1.08 V	40	67.3	37.6
3	*5795.00	95.3 AV			1.08 V	40	57.7	37.6
4	#5944.40	53.6 PK	68.2	-14.6	1.08 V	40	50.1	3.5
5	11590.00	57.0 PK	74.0	-17.0	1.09 V	53	41.6	15.4
6	11590.00	43.5 AV	54.0	-10.5	1.09 V	53	28.1	15.4

Remarks:

1. Emission Level(dBuV/m) = Raw Value(dBuV) + Correction Factor(dB/m)
2. Correction Factor(dB/m) = Antenna Factor(dB/m) + Cable Factor(dB) – Pre-Amplifier Factor(dB)
3. Margin value = Emission Level – Limit value
4. The other emission levels were very low against the limit.
5. " * " : Fundamental frequency.
6. " # " : The radiated frequency is out of the restricted band.

RF Mode	TX 802.11ac (VHT80)	Channel	CH 42 : 5210 MHz
Frequency Range	1GHz ~ 40GHz	Detector Function	Peak (PK) Average (AV)

Antenna Polarity & Test Distance : Horizontal at 3 m

No	Frequency (MHz)	Emission Level (dBuV/m)	Limit (dBuV/m)	Margin (dB)	Antenna Height (m)	Table Angle (Degree)	Raw Value (dBuV)	Correction Factor (dB/m)
1	5150.00	70.2 PK	74.0	-3.8	1.78 H	13	68.0	2.2
2	5150.00	52.6 AV	54.0	-1.4	1.78 H	13	50.4	2.2
3	*5210.00	106.2 PK			1.78 H	13	69.8	36.4
4	*5210.00	97.2 AV			1.78 H	13	60.8	36.4
5	5350.00	51.6 PK	74.0	-22.4	1.78 H	13	49.6	2.0
6	5350.00	38.5 AV	54.0	-15.5	1.78 H	13	36.5	2.0
7	#10420.00	54.7 PK	68.2	-13.5	1.19 H	1	39.5	15.2

Antenna Polarity & Test Distance : Vertical at 3 m

No	Frequency (MHz)	Emission Level (dBuV/m)	Limit (dBuV/m)	Margin (dB)	Antenna Height (m)	Table Angle (Degree)	Raw Value (dBuV)	Correction Factor (dB/m)
1	5150.00	66.0 PK	74.0	-8.0	1.33 V	29	63.8	2.2
2	5150.00	53.5 AV	54.0	-0.5	1.33 V	29	51.3	2.2
3	*5210.00	97.8 PK			1.33 V	29	61.4	36.4
4	*5210.00	88.5 AV			1.33 V	29	52.1	36.4
5	5350.00	49.0 PK	74.0	-25.0	1.33 V	29	47.0	2.0
6	5350.00	38.3 AV	54.0	-15.7	1.33 V	29	36.3	2.0
7	#10420.00	55.7 PK	68.2	-12.5	1.07 V	50	40.5	15.2

Remarks:

1. Emission Level(dBuV/m) = Raw Value(dBuV) + Correction Factor(dB/m)
2. Correction Factor(dB/m) = Antenna Factor(dB/m) + Cable Factor(dB) – Pre-Amplifier Factor(dB)
3. Margin value = Emission Level – Limit value
4. The other emission levels were very low against the limit.
5. " * ": Fundamental frequency.
6. " # ": The radiated frequency is out of the restricted band.

RF Mode	TX 802.11ac (VHT80)	Channel	CH 58 : 5290 MHz
Frequency Range	1GHz ~ 40GHz	Detector Function	Peak (PK) Average (AV)

Antenna Polarity & Test Distance : Horizontal at 3 m

No	Frequency (MHz)	Emission Level (dBuV/m)	Limit (dBuV/m)	Margin (dB)	Antenna Height (m)	Table Angle (Degree)	Raw Value (dBuV)	Correction Factor (dB/m)
1	*5290.00	107.4 PK			1.85 H	10	71.3	36.1
2	*5290.00	98.5 AV			1.85 H	10	62.4	36.1
3	5350.00	72.0 PK	74.0	-2.0	1.85 H	10	70.0	2.0
4	5350.00	53.6 AV	54.0	-0.4	1.85 H	10	51.6	2.0
5	#10580.00	55.0 PK	68.2	-13.2	1.05 H	80	39.4	15.6

Antenna Polarity & Test Distance : Vertical at 3 m

No	Frequency (MHz)	Emission Level (dBuV/m)	Limit (dBuV/m)	Margin (dB)	Antenna Height (m)	Table Angle (Degree)	Raw Value (dBuV)	Correction Factor (dB/m)
1	*5290.00	94.9 PK			1.63 V	32	58.8	36.1
2	*5290.00	86.7 AV			1.63 V	32	50.6	36.1
3	5350.00	61.2 PK	74.0	-12.8	1.63 V	32	59.2	2.0
4	5350.00	43.5 AV	54.0	-10.5	1.63 V	32	41.5	2.0
5	#10580.00	55.2 PK	68.2	-13.0	1.06 V	63	39.6	15.6

Remarks:

1. Emission Level(dBuV/m) = Raw Value(dBuV) + Correction Factor(dB/m)
2. Correction Factor(dB/m) = Antenna Factor(dB/m) + Cable Factor(dB) – Pre-Amplifier Factor(dB)
3. Margin value = Emission Level – Limit value
4. The other emission levels were very low against the limit.
5. " * " : Fundamental frequency.
6. " # " : The radiated frequency is out of the restricted band.

RF Mode	TX 802.11ac (VHT80)	Channel	CH 106 : 5530 MHz
Frequency Range	1GHz ~ 40GHz	Detector Function	Peak (PK) Average (AV)

Antenna Polarity & Test Distance : Horizontal at 3 m

No	Frequency (MHz)	Emission Level (dBuV/m)	Limit (dBuV/m)	Margin (dB)	Antenna Height (m)	Table Angle (Degree)	Raw Value (dBuV)	Correction Factor (dB/m)
1	5460.00	63.0 PK	74.0	-11.0	1.38 H	17	59.6	3.4
2	5460.00	47.7 AV	54.0	-6.3	1.38 H	17	44.3	3.4
3	#5470.00	67.1 PK	68.2	-1.1	1.38 H	17	63.7	3.4
4	*5530.00	103.7 PK			1.38 H	17	66.2	37.5
5	*5530.00	94.9 AV			1.38 H	17	57.4	37.5
6	#5725.00	60.9 PK	68.2	-7.3	1.38 H	17	57.4	3.5
7	11060.00	55.3 PK	74.0	-18.7	1.44 H	91	38.6	16.7
8	11060.00	44.0 AV	54.0	-10.0	1.44 H	91	27.3	16.7

Antenna Polarity & Test Distance : Vertical at 3 m

No	Frequency (MHz)	Emission Level (dBuV/m)	Limit (dBuV/m)	Margin (dB)	Antenna Height (m)	Table Angle (Degree)	Raw Value (dBuV)	Correction Factor (dB/m)
1	5460.00	54.8 PK	74.0	-19.2	2.53 V	29	51.4	3.4
2	5460.00	42.0 AV	54.0	-12.0	2.53 V	29	38.6	3.4
3	#5470.00	54.9 PK	68.2	-13.3	2.53 V	29	51.5	3.4
4	*5530.00	97.9 PK			2.53 V	29	60.4	37.5
5	*5530.00	88.9 AV			2.53 V	29	51.4	37.5
6	#5725.00	54.8 PK	68.2	-13.4	2.53 V	29	51.3	3.5
7	11060.00	55.0 PK	74.0	-19.0	1.12 V	39	38.3	16.7
8	11060.00	44.1 AV	54.0	-9.9	1.12 V	39	27.4	16.7

Remarks:

1. Emission Level(dBuV/m) = Raw Value(dBuV) + Correction Factor(dB/m)
2. Correction Factor(dB/m) = Antenna Factor(dB/m) + Cable Factor(dB) – Pre-Amplifier Factor(dB)
3. Margin value = Emission Level – Limit value
4. The other emission levels were very low against the limit.
5. " * ": Fundamental frequency.
6. " # ": The radiated frequency is out of the restricted band.

RF Mode	TX 802.11ac (VHT80)	Channel	CH 122 : 5610 MHz
Frequency Range	1GHz ~ 40GHz	Detector Function	Peak (PK) Average (AV)

Antenna Polarity & Test Distance : Horizontal at 3 m

No	Frequency (MHz)	Emission Level (dBuV/m)	Limit (dBuV/m)	Margin (dB)	Antenna Height (m)	Table Angle (Degree)	Raw Value (dBuV)	Correction Factor (dB/m)
1	5460.00	63.2 PK	74.0	-10.8	1.73 H	15	59.8	3.4
2	5460.00	47.4 AV	54.0	-6.6	1.73 H	15	44.0	3.4
3	#5470.00	60.1 PK	68.2	-8.1	1.73 H	15	56.7	3.4
4	*5610.00	110.6 PK			1.73 H	15	73.2	37.4
5	*5610.00	102.3 AV			1.73 H	15	64.9	37.4
6	#5725.00	67.6 PK	68.2	-0.6	1.73 H	15	64.1	3.5
7	11220.00	54.6 PK	74.0	-19.4	1.36 H	92	38.2	16.4
8	11220.00	44.2 AV	54.0	-9.8	1.36 H	92	27.8	16.4

Antenna Polarity & Test Distance : Vertical at 3 m

No	Frequency (MHz)	Emission Level (dBuV/m)	Limit (dBuV/m)	Margin (dB)	Antenna Height (m)	Table Angle (Degree)	Raw Value (dBuV)	Correction Factor (dB/m)
1	5460.00	53.0 PK	74.0	-21.0	2.31 V	30	49.6	3.4
2	5460.00	40.9 AV	54.0	-13.1	2.31 V	30	37.5	3.4
3	#5470.00	54.7 PK	68.2	-13.5	2.31 V	30	51.3	3.4
4	*5610.00	104.1 PK			2.31 V	30	66.7	37.4
5	*5610.00	95.0 AV			2.31 V	30	57.6	37.4
6	#5725.00	59.0 PK	68.2	-9.2	2.31 V	30	55.5	3.5
7	11220.00	54.8 PK	74.0	-19.2	1.06 V	42	38.4	16.4
8	11220.00	43.7 AV	54.0	-10.3	1.06 V	42	27.3	16.4

Remarks:

1. Emission Level(dBuV/m) = Raw Value(dBuV) + Correction Factor(dB/m)
2. Correction Factor(dB/m) = Antenna Factor(dB/m) + Cable Factor(dB) – Pre-Amplifier Factor(dB)
3. Margin value = Emission Level – Limit value
4. The other emission levels were very low against the limit.
5. " * " : Fundamental frequency.
6. " # " : The radiated frequency is out of the restricted band.

RF Mode	TX 802.11ac (VHT80)	Channel	CH 138 : 5690 MHz
Frequency Range	1GHz ~ 40GHz	Detector Function	Peak (PK) Average (AV)

Antenna Polarity & Test Distance : Horizontal at 3 m

No	Frequency (MHz)	Emission Level (dBuV/m)	Limit (dBuV/m)	Margin (dB)	Antenna Height (m)	Table Angle (Degree)	Raw Value (dBuV)	Correction Factor (dB/m)
1	*5690.00	109.5 PK			1.68 H	19	71.8	37.7
2	*5690.00	101.7 AV			1.68 H	19	64.0	37.7
3	#5850.00	58.8 PK	68.2	-9.4	1.68 H	19	54.7	4.1
4	11380.00	54.6 PK	74.0	-19.4	1.38 H	96	38.4	16.2
5	11380.00	43.5 AV	54.0	-10.5	1.38 H	96	27.3	16.2

Antenna Polarity & Test Distance : Vertical at 3 m

No	Frequency (MHz)	Emission Level (dBuV/m)	Limit (dBuV/m)	Margin (dB)	Antenna Height (m)	Table Angle (Degree)	Raw Value (dBuV)	Correction Factor (dB/m)
1	*5690.00	105.0 PK			2.34 V	29	67.3	37.7
2	*5690.00	96.0 AV			2.34 V	29	58.3	37.7
3	#5850.00	53.0 PK	68.2	-15.2	2.34 V	29	48.9	4.1
4	11380.00	54.6 PK	74.0	-19.4	1.04 V	58	38.4	16.2
5	11380.00	43.8 AV	54.0	-10.2	1.04 V	58	27.6	16.2

Remarks:

1. Emission Level(dBuV/m) = Raw Value(dBuV) + Correction Factor(dB/m)
2. Correction Factor(dB/m) = Antenna Factor(dB/m) + Cable Factor(dB) – Pre-Amplifier Factor(dB)
3. Margin value = Emission Level – Limit value
4. The other emission levels were very low against the limit.
5. " * " : Fundamental frequency.
6. " # " : The radiated frequency is out of the restricted band.

RF Mode	TX 802.11ac (VHT80)	Channel	CH 155 : 5775 MHz
Frequency Range	1GHz ~ 40GHz	Detector Function	Peak (PK) Average (AV)

Antenna Polarity & Test Distance : Horizontal at 3 m

No	Frequency (MHz)	Emission Level (dBuV/m)	Limit (dBuV/m)	Margin (dB)	Antenna Height (m)	Table Angle (Degree)	Raw Value (dBuV)	Correction Factor (dB/m)
1	#5648.80	67.4 PK	68.2	-0.8	1.70 H	16	64.6	2.8
2	*5775.00	110.9 PK			1.70 H	16	73.4	37.5
3	*5775.00	100.7 AV			1.70 H	16	63.2	37.5
4	#5938.00	56.0 PK	68.2	-12.2	1.70 H	16	52.5	3.5
5	11550.00	56.2 PK	74.0	-17.8	1.17 H	33	40.6	15.6
6	11550.00	43.0 AV	54.0	-11.0	1.17 H	33	27.4	15.6

Antenna Polarity & Test Distance : Vertical at 3 m

No	Frequency (MHz)	Emission Level (dBuV/m)	Limit (dBuV/m)	Margin (dB)	Antenna Height (m)	Table Angle (Degree)	Raw Value (dBuV)	Correction Factor (dB/m)
1	#5649.20	59.8 PK	68.2	-8.4	1.07 V	37	57.0	2.8
2	*5775.00	101.8 PK			1.07 V	37	64.3	37.5
3	*5775.00	92.0 AV			1.07 V	37	54.5	37.5
4	#5985.20	53.0 PK	68.2	-15.2	1.07 V	37	49.6	3.4
5	11550.00	57.1 PK	74.0	-16.9	2.07 V	157	41.5	15.6
6	11550.00	43.5 AV	54.0	-10.5	2.07 V	157	27.9	15.6

Remarks:

1. Emission Level(dBuV/m) = Raw Value(dBuV) + Correction Factor(dB/m)
2. Correction Factor(dB/m) = Antenna Factor(dB/m) + Cable Factor(dB) – Pre-Amplifier Factor(dB)
3. Margin value = Emission Level – Limit value
4. The other emission levels were very low against the limit.
5. " * " : Fundamental frequency.
6. " # " : The radiated frequency is out of the restricted band.

Below 1GHz Worst-Case Data:

RF Mode	TX 802.11n (HT20)	Channel	CH 64 : 5320 MHz
Frequency Range	30MHz ~ 1GHz	Detector Function	Quasi-Peak (QP)

Antenna Polarity & Test Distance : Horizontal at 3 m								
No	Frequency (MHz)	Emission Level (dBuV/m)	Limit (dBuV/m)	Margin (dB)	Antenna Height (m)	Table Angle (Degree)	Raw Value (dBuV)	Correction Factor (dB/m)
1	33.88	22.78 QP	40.00	-17.22	1.00 H	45	32.87	-10.09
2	59.10	25.08 QP	40.00	-14.92	1.50 H	243	34.40	-9.32
3	152.22	22.80 QP	43.50	-20.70	2.00 H	167	31.10	-8.30
4	305.48	24.00 QP	46.00	-22.00	1.50 H	91	30.61	-6.61
5	499.48	30.43 QP	46.00	-15.57	1.25 H	22	33.09	-2.66
6	914.64	35.80 QP	46.00	-10.20	1.00 H	61	30.33	5.47

Remarks:

1. Emission Level(dBuV/m) = Raw Value(dBuV) + Correction Factor(dB/m)
2. Correction Factor(dB/m) = Antenna Factor(dB/m) + Cable Factor(dB) – Pre-Amplifier Factor(dB)
3. Margin value = Emission Level – Limit value
4. The other emission levels were very low against the limit of frequency range 30MHz~1000MHz.
5. The emission levels were very low against the limit of frequency range 9kHz~30MHz: the amplitude of spurious emissions attenuated more than 20 dB below the permissible value to be report.

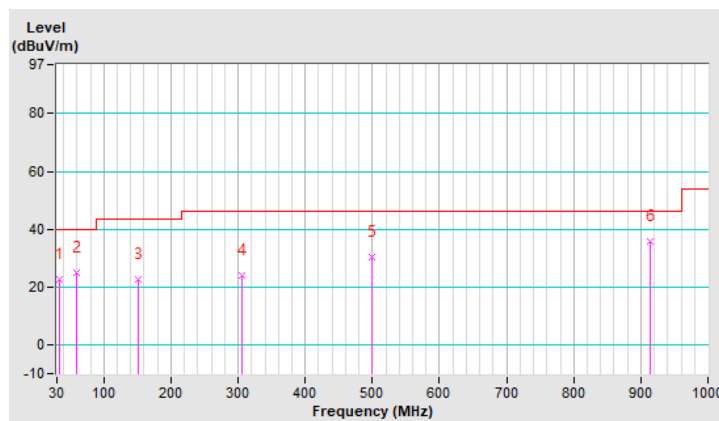

RF Mode	TX 802.11a	Channel	CH 64 : 5320 MHz
Frequency Range	30MHz ~ 1GHz	Detector Function	Quasi-Peak (QP)

Antenna Polarity & Test Distance : Vertical at 3 m								
No	Frequency (MHz)	Emission Level (dBuV/m)	Limit (dBuV/m)	Margin (dB)	Antenna Height (m)	Table Angle (Degree)	Raw Value (dBuV)	Correction Factor (dB/m)
1	30.00	30.83 QP	40.00	-9.17	2.00 V	314	41.15	-10.32
2	70.74	29.63 QP	40.00	-10.37	1.00 V	14	40.53	-10.90
3	152.22	24.21 QP	43.50	-19.29	1.25 V	17	32.51	-8.30
4	334.58	24.08 QP	46.00	-21.92	2.00 V	316	30.04	-5.96
5	470.38	28.13 QP	46.00	-17.87	1.50 V	9	31.19	-3.06
6	891.36	34.70 QP	46.00	-11.30	1.25 V	358	30.02	4.68

Remarks:

1. Emission Level(dBuV/m) = Raw Value(dBuV) + Correction Factor(dB/m)
2. Correction Factor(dB/m) = Antenna Factor(dB/m) + Cable Factor(dB) – Pre-Amplifier Factor(dB)
3. Margin value = Emission Level – Limit value
4. The other emission levels were very low against the limit of frequency range 30MHz~1000MHz.
5. The emission levels were very low against the limit of frequency range 9kHz~30MHz: the amplitude of spurious emissions attenuated more than 20 dB below the permissible value to be report.

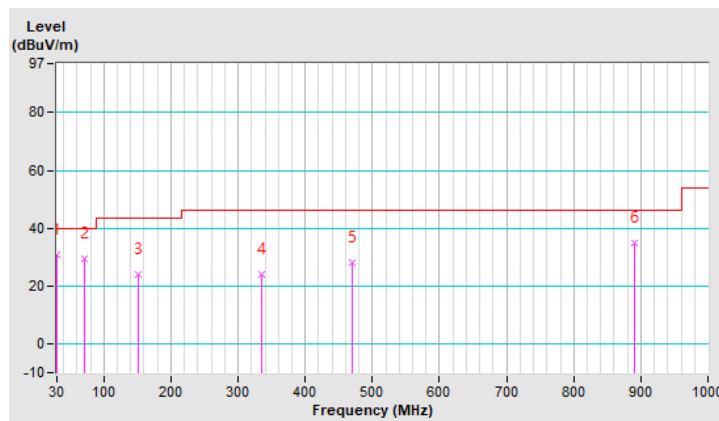

4.2 Conducted Emission Measurement

4.2.1 Limits of Conducted Emission Measurement

Frequency (MHz)	Conducted Limit (dBuV)	
	Quasi-peak	Average
0.15 - 0.5	66 - 56	56 - 46
0.50 - 5.0	56	46
5.0 - 30.0	60	50

Note: 1. The lower limit shall apply at the transition frequencies.
 2. The limit decreases in line with the logarithm of the frequency in the range of 0.15 to 0.50MHz.

4.2.2 Test Instruments

Description & Manufacturer	Model No.	Serial No.	Cal. Date	Cal. Due
ROHDE & SCHWARZ TEST RECEIVER	ESCS30	100276	Apr. 16, 2020	Apr. 15, 2021
SCHWARZBECK Artificial Mains Network (for EUT)	NSLK 8128	8128-244	Nov. 19, 2020	Nov. 18, 2021
LISN With Adapter (for EUT)	AD10	C05Ada-001	Nov. 19, 2020	Nov. 18, 2021
R&S Artificial Mains Network (for peripheral)	ESH3-Z5	100312	Aug. 18, 2020	Aug. 17, 2021
Software	Cond_V7.3.7.4	NA	NA	NA
RF cable (JYEBAO) With 10dB PAD	5D-FB	Cable-C05.01	Jan. 30, 2020	Jan. 29, 2021
LYNICS Terminator (For R&S LISN)	0900510	E1-01-305	Feb. 17, 2020	Feb. 16, 2021

Note: 1. The calibration interval of the above test instruments is 12 months and the calibrations are traceable to NML/ROC and NIST/USA.
 2. The test was performed in LinKou Shielded Room 5. (Conduction 5)
 3. The VCCI Site Registration No. is C-11093.

4.2.3 Test Procedures

- The EUT was placed 0.4 meters from the conducting wall of the shielded room with EUT being connected to the power mains through a line impedance stabilization network (LISN). Other support units were connected to the power mains through another LISN. The two LISNs provide 50 ohm/ 50uH of coupling impedance for the measuring instrument.
- Both lines of the power mains connected to the EUT were checked for maximum conducted interference.
- The frequency range from 150kHz to 30MHz was searched. Emission levels under (Limit - 20dB) was not recorded.

Note: The resolution bandwidth and video bandwidth of test receiver is 9kHz for quasi-peak detection (QP) and average detection (AV) at frequency 0.15MHz-30MHz.

4.2.4 Deviation from Test Standard

No deviation.

4.2.5 Test Setup

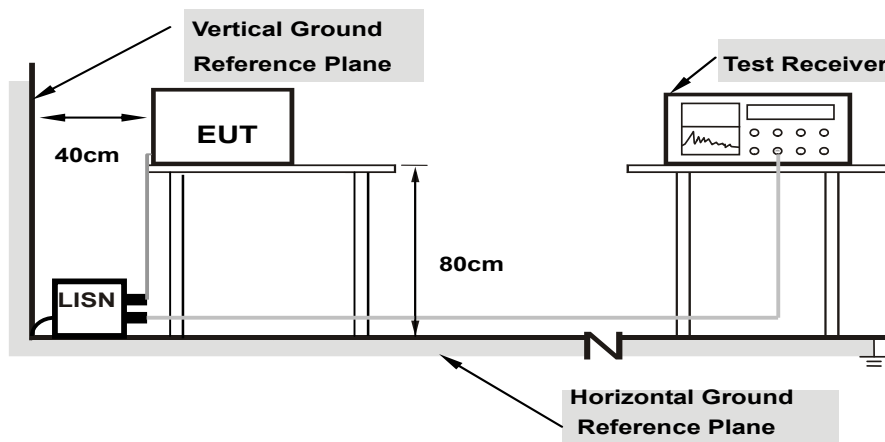

Note: 1.Support units were connected to second LISN.

For the actual test configuration, please refer to the attached file (Test Setup Photo).

4.2.6 EUT Operating Conditions

Same as 4.1.6.

4.2.7 Test Results

Worst-case data:

802.11n (HT20)

Phase	Line (L)	Detector Function	Quasi-Peak (QP) / Average (AV)
-------	----------	-------------------	--------------------------------

No	Freq. [MHz]	Corr. Factor (dB)	Reading Value [dB (uV)]		Emission Level [dB (uV)]		Limit [dB (uV)]		Margin (dB)	
			Q.P.	AV.	Q.P.	AV.	Q.P.	AV.	Q.P.	AV.
			1	0.15391	9.89	34.50	18.50	44.39	28.39	65.79
2	0.42344	9.91	27.87	24.57	37.78	34.48	57.38	47.38	-19.60	-12.90
3	0.69688	9.92	18.62	12.16	28.54	22.08	56.00	46.00	-27.46	-23.92
4	2.92188	9.99	18.04	7.97	28.03	17.96	56.00	46.00	-27.97	-28.04
5	11.28516	10.20	21.37	10.00	31.57	20.20	60.00	50.00	-28.43	-29.80
6	19.26953	10.41	6.99	1.20	17.40	11.61	60.00	50.00	-42.60	-38.39

Remarks:

1. Q.P. and AV. are abbreviations of quasi-peak and average individually.
2. The emission levels of other frequencies were very low against the limit.
3. Margin value = Emission level - Limit value
4. Correction factor = Insertion loss + Cable loss
5. Emission Level = Correction Factor + Reading Value.

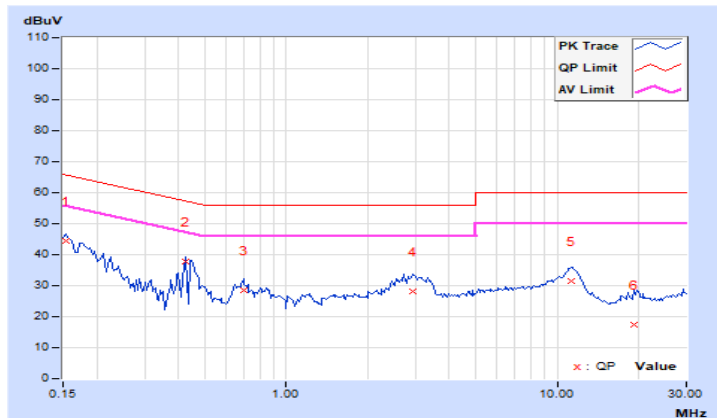

Phase	Neutral (N)	Detector Function	Quasi-Peak (QP) / Average (AV)
-------	-------------	-------------------	--------------------------------

No	Freq. [MHz]	Corr. Factor (dB)	Reading Value [dB (uV)]		Emission Level [dB (uV)]		Limit [dB (uV)]		Margin (dB)	
			Q.P.	AV.	Q.P.	AV.	Q.P.	AV.	Q.P.	AV.
			1	0.15391	9.90	34.27	18.73	44.17	28.63	65.79
2	0.42734	9.92	28.03	19.73	37.95	29.65	57.30	47.30	-19.35	-17.65
3	0.70078	9.94	17.75	11.64	27.69	21.58	56.00	46.00	-28.31	-24.42
4	3.13281	10.01	19.21	9.41	29.22	19.42	56.00	46.00	-26.78	-26.58
5	11.51953	10.22	20.57	8.14	30.79	18.36	60.00	50.00	-29.21	-31.64
6	19.79688	10.45	9.17	0.09	19.62	10.54	60.00	50.00	-40.38	-39.46

Remarks:

1. Q.P. and AV. are abbreviations of quasi-peak and average individually.
2. The emission levels of other frequencies were very low against the limit.
3. Margin value = Emission level - Limit value
4. Correction factor = Insertion loss + Cable loss
5. Emission Level = Correction Factor + Reading Value.

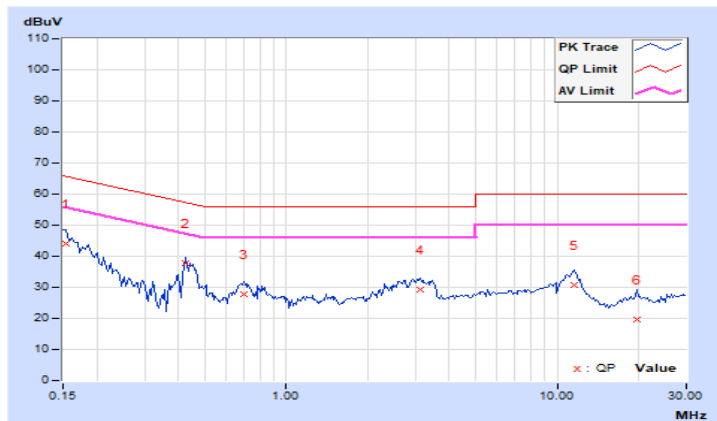

4.3 Transmit Power Measurement

4.3.1 Limits of Transmit Power Measurement

Operation Band	EUT Category		Limit
U-NII-1		Outdoor Access Point	1 Watt (30 dBm) (Max. e.i.r.p \leq 125mW(21 dBm) at any elevation angle above 30 degrees as measured from the horizon)
		Fixed point-to-point Access Point	1 Watt (30 dBm)
		Indoor Access Point	1 Watt (30 dBm)
	√	Mobile and Portable client device	250mW (24 dBm)
U-NII-2A	√		250mW (24 dBm) or 11 dBm+10 log B*
U-NII-2C	√		250mW (24 dBm) or 11 dBm+10 log B*
U-NII-3	√		1 Watt (30 dBm)

*B is the 26 dB emission bandwidth in megahertz

Per KDB 662911 Method of conducted output power measurement on IEEE 802.11 devices,

Array Gain = 0 dB (i.e., no array gain) for $N_{ANT} \leq 4$;

Array Gain = 0 dB (i.e., no array gain) for channel widths ≥ 40 MHz for any N_{ANT} ;

Array Gain = $5 \log(N_{ANT}/N_{SS})$ dB or 3 dB, whichever is less for 20-MHz channel widths with $N_{ANT} \geq 5$.

For power measurements on all other devices: Array Gain = $10 \log(N_{ANT}/N_{SS})$ dB.

4.3.2 Test Setup

For Power Output

802.11a, 802.11n (HT20), 802.11n (HT40)

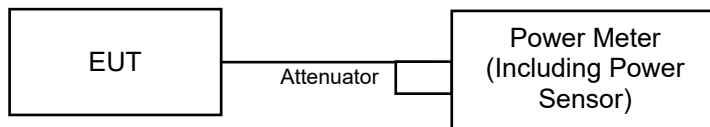

802.11ac (VHT80)

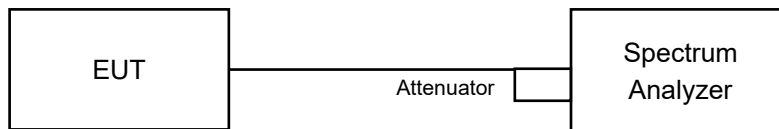

For 26dB Bandwidth

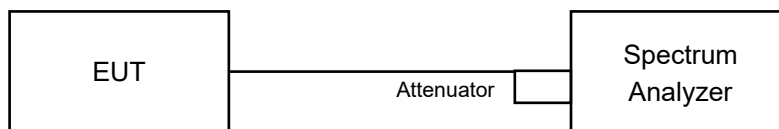

4.3.3 Test Instruments

Refer to section 4.1.2 to get information of above instrument.

4.3.4 Test Procedure

For Average Power Measurement

Method PM is used to perform output power measurement, trigger and gating function of wide band power meter is enabled to measure max output power of TX on burst and set the detector to average. Duty factor is not added to measured value.

For 802.11a, 802.11n (HT20), 802.11n (HT40)

Method PM is used to perform output power measurement, trigger and gating function of wide band power meter is enabled to measure max output power of TX on burst. Duty factor is not added to measured value.

For 802.11ac (VHT80) and straddle channels

- a. Set span to encompass the entire 26 dB EBW (or, alternatively, the entire 99% occupied bandwidth) of the signal.
- b. Set sweep trigger to "free run".
- c. Set RBW = 1 MHz
- d. Set VBW \geq 3 MHz
- e. Number of points in sweep \geq 2 Span / RBW
- f. Sweep time \leq (number of points in sweep) * T
- g. Using emission bandwidth to determine the frequency span for integration the channel bandwidth.
- h. Detector = RMS
- i. Trace mode = max hold
- j. Allow max hold to run for at least 60 seconds, or longer as needed to allow the trace to stabilize.
- k. Compute power by integrating the spectrum across the EBW (or, alternatively, the entire 99% occupied bandwidth) of the signal using the instrument's band power measurement function with band limits set equal to the EBW (or occupied bandwidth) band edges. If the instrument does not have a band power function, sum the spectrum levels (in power units) at 1 MHz intervals extending across the EBW (or, alternatively, the entire 99% occupied bandwidth) of the spectrum.

For 26dB Bandwidth

- a. Set RBW = approximately 1% of the emission bandwidth.
- b. Set the VBW > RBW.
- c. Detector = Peak.
- d. Trace mode = max hold.
- e. Measure the maximum width of the emission that is 26 dB down from the peak of the emission. Compare this with the RBW setting of the analyzer. Readjust RBW and repeat measurement as needed until the RBW/EBW ratio is approximately 1%.
- f. For channel aggregation (channel 138, 142, 144) measurement refer to KDB 789033 D02 Section III. CHANNEL AGGREGATION.

4.3.5 Deviation from Test Standard

No deviation.

4.3.6 EUT Operating Conditions

The software provided by client to enable the EUT under transmission condition continuously at lowest, middle and highest channel frequencies individually.

4.3.7 Test Result

Power Output:
802.11a

Chan.	Freq. (MHz)	Maximum Conducted Power (dBm)		Total Power (mW)	Total Power (dBm)	Power Limit (dBm)	Pass / Fail
		Chain 0	Chain 1				
36	5180	18.68	18.69	147.751	21.70	24.00	Pass
40	5200	18.66	18.61	146.062	21.65	24.00	Pass
48	5240	18.75	18.82	151.197	21.80	24.00	Pass
52	5260	18.53	18.66	144.737	21.61	24.00	Pass
60	5300	18.46	18.70	144.277	21.59	24.00	Pass
64	5320	18.52	18.80	146.979	21.67	24.00	Pass
100	5500	18.50	18.28	138.092	21.40	24.00	Pass
116	5580	18.51	18.09	135.375	21.32	24.00	Pass
140	5700	18.73	18.37	143.352	21.56	24.00	Pass
144	5720 (For U-NII-2C)	16.71	16.21	88.664	19.48	23.94	Pass
144	5720 (For U-NII-3)	10.47	10.01	21.166	13.26	30.00	Pass
149	5745	21.13	21.52	271.624	24.34	30.00	Pass
157	5785	20.19	20.53	217.452	23.37	30.00	Pass
165	5825	18.86	19.23	160.666	22.06	30.00	Pass

Note:

For U-NII-2A, U-NII-2C Band:

Chain 0

1. $11\text{dBm} + 10\log(23.88) = 24.78 > 24\text{dBm}$
2. $11\text{dBm} + 10\log(23.87) = 24.77 > 24\text{dBm}$
3. $11\text{dBm} + 10\log(25.86) = 25.12 > 24\text{dBm}$
4. $11\text{dBm} + 10\log(24.12) = 24.82 > 24\text{dBm}$
5. $11\text{dBm} + 10\log(24.06) = 24.81 > 24\text{dBm}$
6. $11\text{dBm} + 10\log(35.39) = 26.48 > 24\text{dBm}$
7. $11\text{dBm} + 10\log(5725.00 - 5704.60) = 24.09 > 24\text{dBm}$

Chain 1

1. $11\text{dBm} + 10\log(25.66) = 25.09 > 24\text{dBm}$
2. $11\text{dBm} + 10\log(26.21) = 25.18 > 24\text{dBm}$
3. $11\text{dBm} + 10\log(27.25) = 25.35 > 24\text{dBm}$
4. $11\text{dBm} + 10\log(23.98) = 24.79 > 24\text{dBm}$
5. $11\text{dBm} + 10\log(24.51) = 24.89 > 24\text{dBm}$
6. $11\text{dBm} + 10\log(28.34) = 25.52 > 24\text{dBm}$
7. $11\text{dBm} + 10\log(5725.00 - 5705.30) = 23.94 < 24\text{dBm}$

802.11n (HT20)

Chan.	Freq. (MHz)	Maximum Conducted Power (dBm)		Total Power (mW)	Total Power (dBm)	Power Limit (dBm)	Pass / Fail
		Chain 0	Chain 1				
36	5180	18.73	18.75	149.634	21.75	24.00	Pass
40	5200	18.77	18.84	151.895	21.82	24.00	Pass
48	5240	18.87	18.95	155.614	21.92	24.00	Pass
52	5260	18.70	18.83	150.515	21.78	24.00	Pass
60	5300	18.68	18.86	150.703	21.78	24.00	Pass
64	5320	18.69	18.93	152.123	21.82	24.00	Pass
100	5500	18.21	18.81	142.254	21.53	24.00	Pass
116	5580	18.67	18.68	147.411	21.69	24.00	Pass
140	5700	18.11	18.02	128.101	21.08	24.00	Pass
144	5720 (For U-NII-2C)	16.47	16.91	93.452	19.71	24.00	Pass
144	5720 (For U-NII-3)	10.25	10.44	21.659	13.36	30.00	Pass
149	5745	21.22	21.58	276.314	24.41	30.00	Pass
157	5785	20.23	20.55	218.940	23.40	30.00	Pass
165	5825	18.93	19.22	161.723	22.09	30.00	Pass

Note:

For U-NII-2A, U-NII-2C Band:

Chain 0

1. $11\text{dBm} + 10\log(28.30) = 25.51 > 24\text{dBm}$
2. $11\text{dBm} + 10\log(27.50) = 25.39 > 24\text{dBm}$
3. $11\text{dBm} + 10\log(28.60) = 25.56 > 24\text{dBm}$
4. $11\text{dBm} + 10\log(27.45) = 25.38 > 24\text{dBm}$
5. $11\text{dBm} + 10\log(28.62) = 25.56 > 24\text{dBm}$
6. $11\text{dBm} + 10\log(29.62) = 25.71 > 24\text{dBm}$
7. $11\text{dBm} + 10\log(5725.00 - 5702.34) = 24.55 > 24\text{dBm}$

Chain 1

1. $11\text{dBm} + 10\log(26.80) = 25.28 > 24\text{dBm}$
2. $11\text{dBm} + 10\log(27.50) = 25.39 > 24\text{dBm}$
3. $11\text{dBm} + 10\log(28.42) = 25.53 > 24\text{dBm}$
4. $11\text{dBm} + 10\log(24.10) = 24.82 > 24\text{dBm}$
5. $11\text{dBm} + 10\log(28.13) = 25.49 > 24\text{dBm}$
6. $11\text{dBm} + 10\log(29.77) = 25.73 > 24\text{dBm}$
7. $11\text{dBm} + 10\log(5725.00 - 5703.82) = 24.25 > 24\text{dBm}$

802.11n (HT40)

Chan.	Freq. (MHz)	Maximum Conducted Power (dBm)		Total Power (mW)	Total Power (dBm)	Power Limit (dBm)	Pass / Fail
		Chain 0	Chain 1				
38	5190	15.61	15.75	73.975	18.69	24.00	Pass
46	5230	20.51	20.59	227.012	23.56	24.00	Pass
54	5270	20.41	20.65	226.045	23.54	24.00	Pass
62	5310	16.11	16.40	84.484	19.27	24.00	Pass
102	5510	15.25	16.16	74.801	18.74	24.00	Pass
110	5550	20.34	20.66	224.556	23.51	24.00	Pass
134	5670	18.83	19.58	167.166	22.23	24.00	Pass
142	5710 (For U-NII-2C)	20.72	20.86	250.036	23.98	24.00	Pass
142	5710 (For U-NII-3)	9.80	9.48	19.197	12.83	30.00	Pass
151	5755	20.95	21.24	257.497	24.11	30.00	Pass
159	5795	19.57	19.93	188.974	22.76	30.00	Pass

Note:

For U-NII-2A, U-NII-2C Band:

Chain 0

1. $11\text{dBm} + 10\log(83.25) = 30.20 > 24\text{dBm}$
2. $11\text{dBm} + 10\log(49.34) = 27.93 > 24\text{dBm}$
3. $11\text{dBm} + 10\log(48.62) = 27.86 > 24\text{dBm}$
4. $11\text{dBm} + 10\log(83.15) = 30.19 > 24\text{dBm}$
5. $11\text{dBm} + 10\log(83.70) = 30.22 > 24\text{dBm}$
6. $11\text{dBm} + 10\log(5725.00 - 5663.84) = 28.86 > 24\text{dBm}$

Chain 1

1. $11\text{dBm} + 10\log(83.23) = 30.20 > 24\text{dBm}$
2. $11\text{dBm} + 10\log(49.30) = 27.92 > 24\text{dBm}$
3. $11\text{dBm} + 10\log(48.67) = 27.87 > 24\text{dBm}$
4. $11\text{dBm} + 10\log(83.04) = 30.19 > 24\text{dBm}$
5. $11\text{dBm} + 10\log(83.73) = 30.22 > 24\text{dBm}$
6. $11\text{dBm} + 10\log(5725.00 - 5663.87) = 28.86 > 24\text{dBm}$

802.11ac (VHT80)

Chan.	Freq. (MHz)	Maximum Conducted Power (dBm)		Total Power (mW)	Total Power (dBm)	Power Limit (dBm)	Pass / Fail
		Chain 0	Chain 1				
42	5210	14.99	15.10	63.909	18.06	24.00	Pass
58	5290	15.23	15.44	68.337	18.35	24.00	Pass
106	5530	11.74	12.44	32.467	15.11	24.00	Pass
122	5610	12.72	13.52	41.197	16.15	24.00	Pass
138	5690 (For U-NII-2C)	20.51	20.59	248.247	23.95	24.00	Pass
138	5690 (For U-NII-3)	5.10	5.02	7.013	8.46	30.00	Pass
155	5775	18.10	18.14	129.728	21.13	30.00	Pass

Note:

For U-NII-2A, U-NII-2C Band:

Chain 0

1. $11\text{dBm} + 10\log(82.35) = 30.15 > 24\text{dBm}$
2. $11\text{dBm} + 10\log(82.36) = 30.15 > 24\text{dBm}$
3. $11\text{dBm} + 10\log(168.08) = 33.25 > 24\text{dBm}$
4. $11\text{dBm} + 10\log(5725.00 - 5593.92) = 32.17 > 24\text{dBm}$

Chain 1

1. $11\text{dBm} + 10\log(82.41) = 30.15 > 24\text{dBm}$
2. $11\text{dBm} + 10\log(82.41) = 30.15 > 24\text{dBm}$
3. $11\text{dBm} + 10\log(167.83) = 33.24 > 24\text{dBm}$
4. $11\text{dBm} + 10\log(5725.00 - 5593.99) = 32.17 > 24\text{dBm}$

Straddle channel power plots:

802.11a

Chain 0

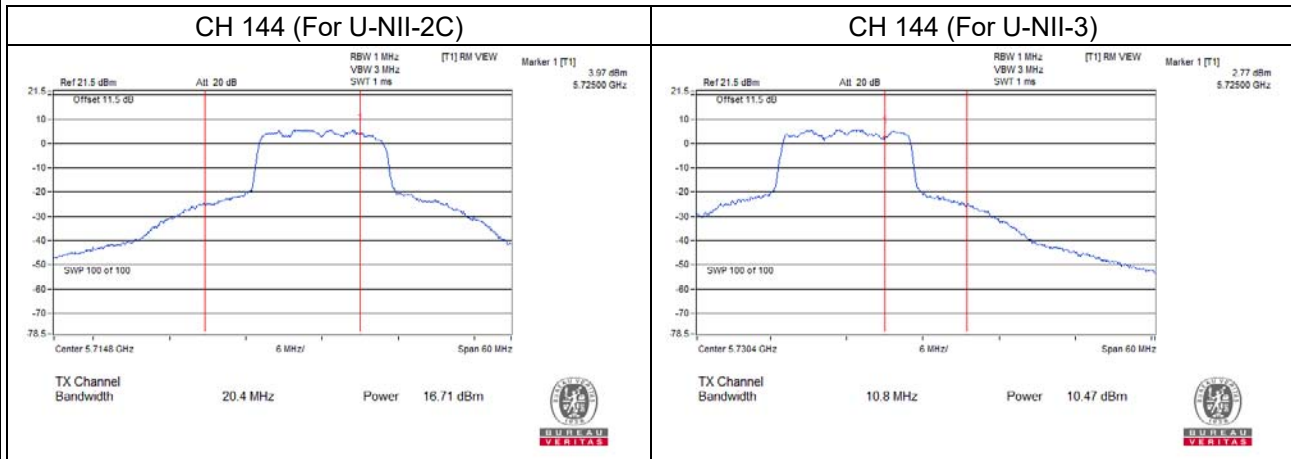

Chain 1

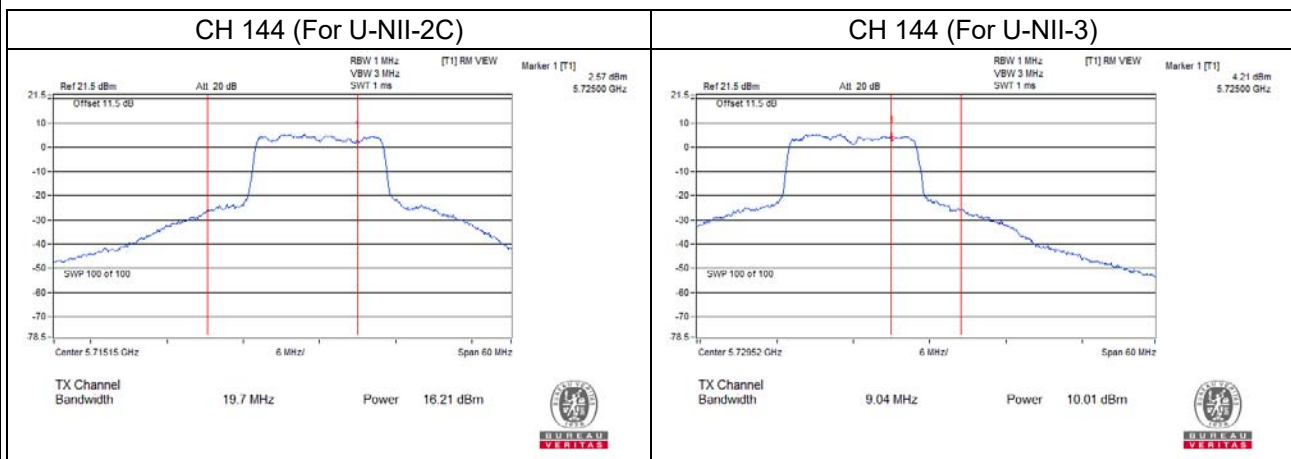

802.11n (HT20)
Chain 0

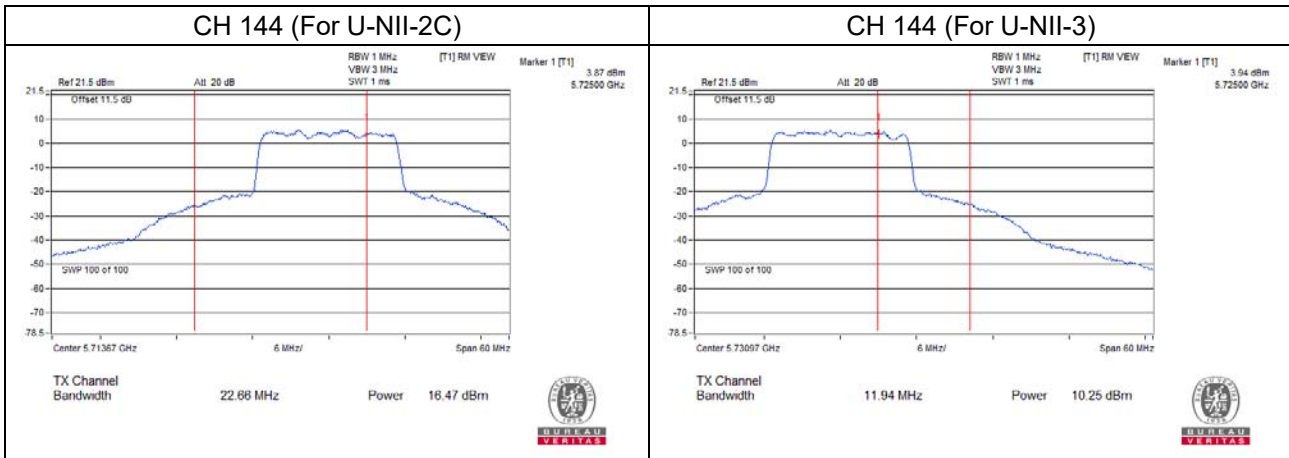

Chain 1

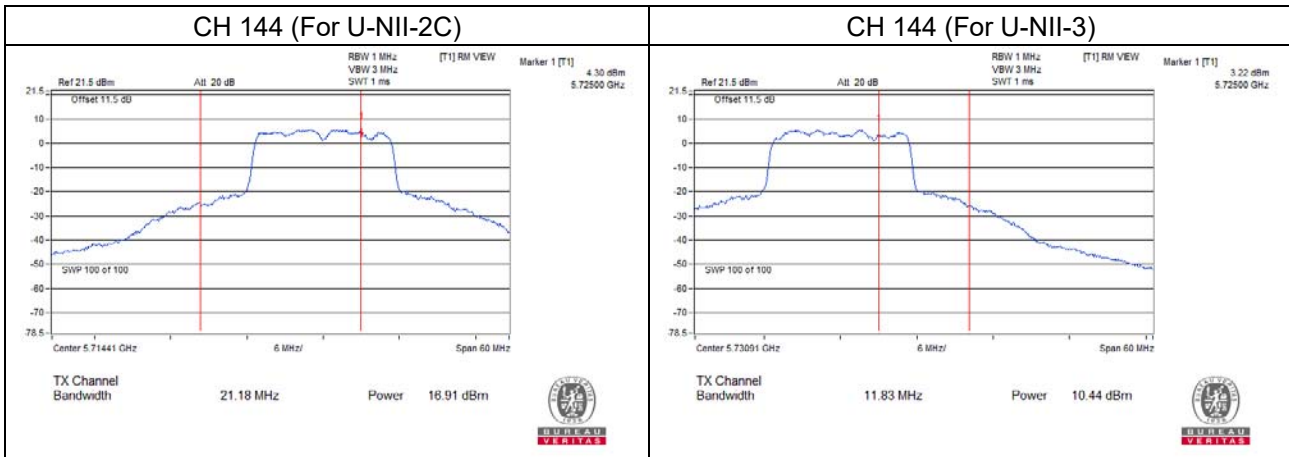

802.11n (HT40)
Chain 0

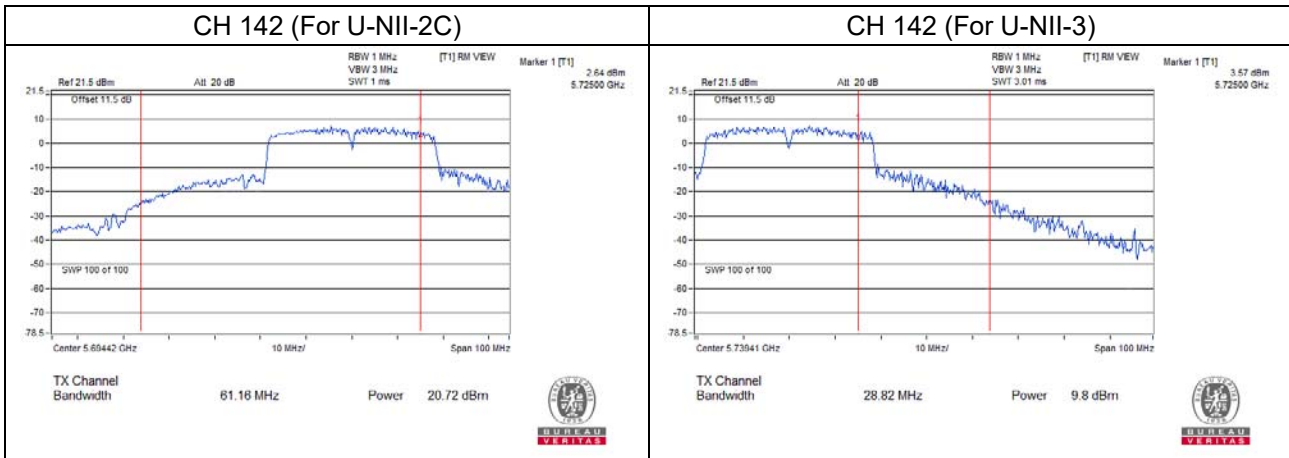

Chain 1

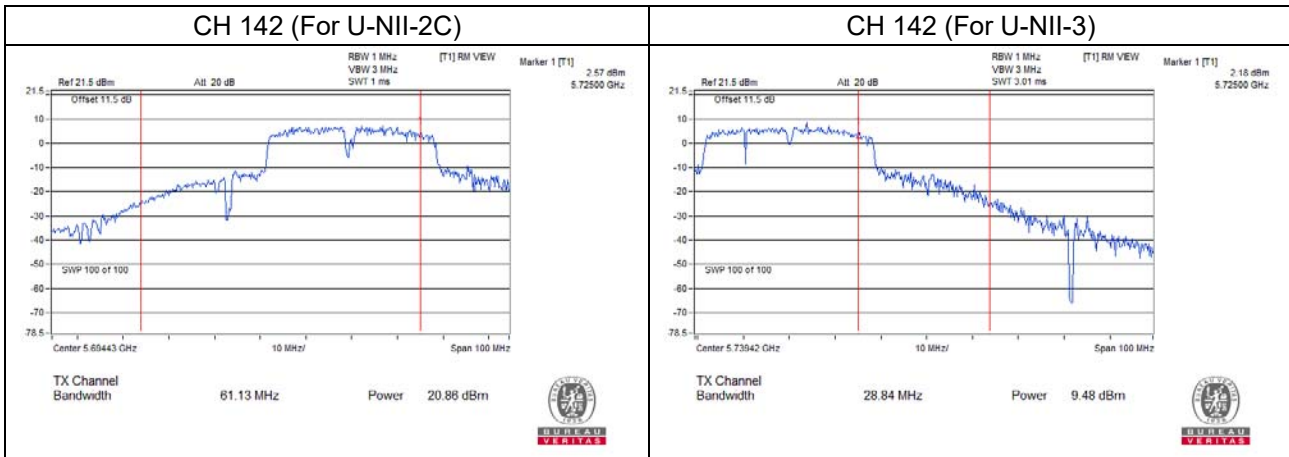

802.11ac (VHT80)
Chain 0

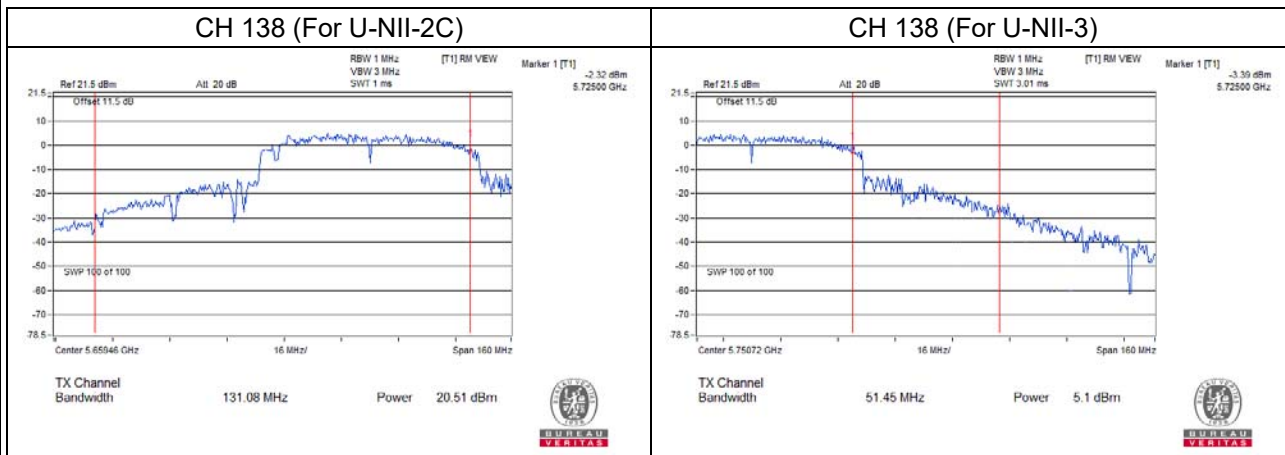

Chain 1

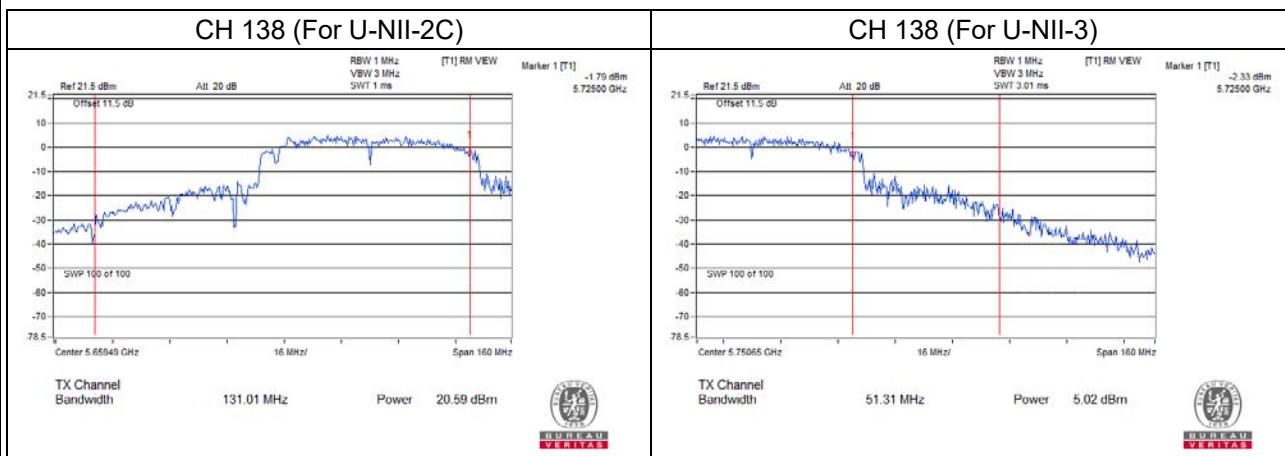

26dB Bandwidth:

802.11a

Chan.	Freq. (MHz)	26dBc Bandwidth (MHz)	
		Chain 0	Chain 1
52	5260	23.88	25.66
60	5300	23.87	26.21
64	5320	25.86	27.25
100	5500	24.12	23.98
116	5580	24.06	24.51
140	5700	35.39	28.34
144	5720 (For U-NII-2C)	20.40	19.70
144	5720 (For U-NII-3)	10.80	9.04

802.11n (HT20)

Chan.	Freq. (MHz)	26dBc Bandwidth (MHz)	
		Chain 0	Chain 1
52	5260	28.30	26.80
60	5300	27.50	27.50
64	5320	28.60	28.42
100	5500	27.45	24.10
116	5580	28.62	28.13
140	5700	29.62	29.77
144	5720 (For U-NII-2C)	22.66	21.18
144	5720 (For U-NII-3)	11.94	11.83

802.11n (HT40)

Chan.	Freq. (MHz)	26dBc Bandwidth (MHz)	
		Chain 0	Chain 1
54	5270	83.25	83.23
62	5310	49.34	49.30
102	5510	48.62	48.67
110	5550	83.15	83.04
134	5670	83.70	83.73
142	5710 (For U-NII-2C)	61.16	61.13
142	5710 (For U-NII-3)	28.82	28.84

802.11ac (VHT80)

Chan.	Freq. (MHz)	26dBc Bandwidth (MHz)	
		Chain 0	Chain 1
58	5290	82.35	82.41
106	5530	82.36	82.41
122	5610	168.08	167.83
138	5690 (For U-NII-2C)	131.08	131.01
138	5690 (For U-NII-3)	51.45	51.31

Spectrum Plot of Worst Value

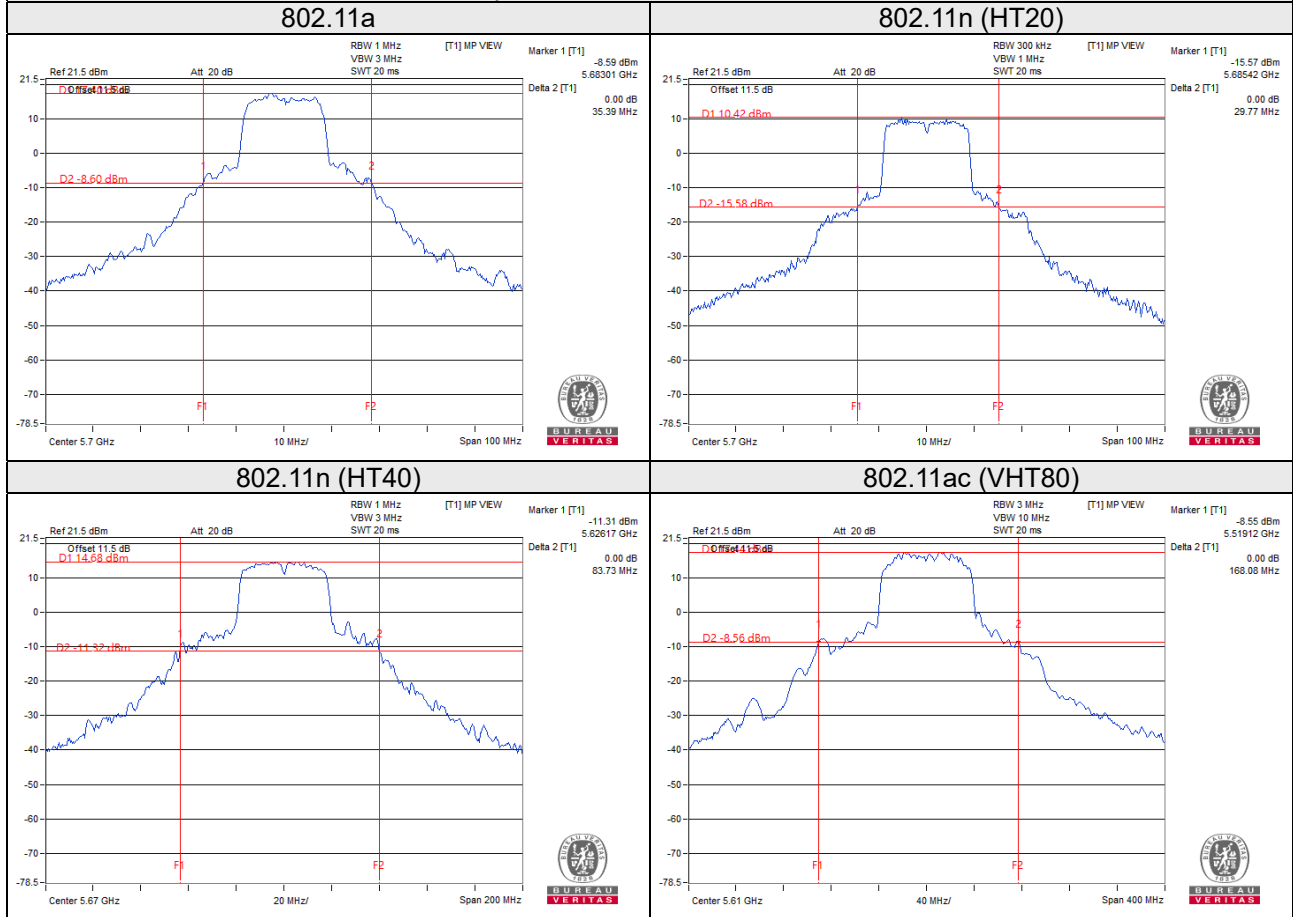

EUT Maximum Conducted Power

802.11a

Frequency Band (MHz)	Max. Power	
	Output Power (mW)	Output Power (dBm)
5250~5350	146.979	21.67
5470~5725	143.352	21.56

802.11n (HT20)

Frequency Band (MHz)	Max. Power	
	Output Power (mW)	Output Power (dBm)
5250~5350	152.123	21.82
5470~5725	147.411	21.69

802.11n (HT40)

Frequency Band (MHz)	Max. Power	
	Output Power (mW)	Output Power (dBm)
5250~5350	226.045	23.54
5470~5725	250.036	23.98

802.11ac (VHT80)

Frequency Band (MHz)	Max. Power	
	Output Power (mW)	Output Power (dBm)
5250~5350	68.337	18.35
5470~5725	248.247	23.95

4.4 Occupied Bandwidth Measurement

4.4.1 Test Setup

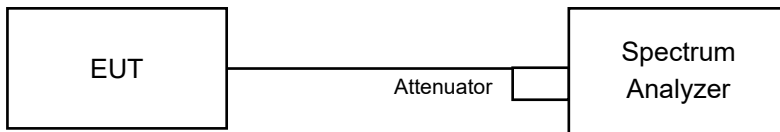

4.4.2 Test Instruments

Refer to section 4.1.2 to get information of above instrument.

4.4.3 Test Procedure

The transmitter output was connected to the spectrum analyzer through an attenuator. The bandwidth of the fundamental frequency was measured by spectrum analyzer with resolution bandwidth in the range of 1% to 5% of the anticipated emission bandwidth, and a video bandwidth at least 3x the resolution bandwidth and set the detector to sampling. The width of a frequency band such that, below the lower and above the upper frequency limits, the mean powers emitted are each equal to a specified percentage 0.5 %of the total mean power of a given emission.

4.4.4 Test Result

802.11a

Chan.	Freq. (MHz)	Occupied Bandwidth (MHz)	
		Chain 0	Chain 1
36	5180	16.56	16.56
40	5200	16.44	16.44
48	5240	16.56	16.56
52	5260	16.56	16.44
60	5300	16.44	16.44
64	5320	16.56	16.56
100	5500	16.44	16.44
116	5580	16.56	16.44
140	5700	16.68	16.68
144	5720 (For U-NII-2C)	13.52	13.40
144	5720 (For U-NII-3)	3.28	3.28
149	5745	29.76	29.40
157	5785	28.80	27.84
165	5825	27.72	25.80

802.11n (HT20)

Chan.	Freq. (MHz)	Occupied Bandwidth (MHz)	
		Chain 0	Chain 1
36	5180	17.64	17.64
40	5200	17.64	17.64
48	5240	17.64	17.64
52	5260	17.64	17.64
60	5300	17.64	17.64
64	5320	17.76	17.76
100	5500	17.64	17.64
116	5580	17.64	17.64
140	5700	17.88	17.76
144	5720 (For U-NII-2C)	14.00	14.00
144	5720 (For U-NII-3)	3.88	3.88
149	5745	32.64	32.76
157	5785	31.32	31.92
165	5825	29.28	29.40

802.11n (HT40)

Chan.	Freq. (MHz)	Occupied Bandwidth (MHz)	
		Chain 0	Chain 1
38	5190	36.60	36.48
46	5230	37.32	37.44
54	5270	37.32	37.56
62	5310	36.60	36.72
102	5510	36.72	36.72
110	5550	37.44	37.44
134	5670	37.68	37.80
142	5710 (For U-NII-2C)	36.00	36.12
142	5710 (For U-NII-3)	6.12	6.24
151	5755	46.50	46.56
159	5795	44.40	44.76

802.11ac (VHT80)

Chan.	Freq. (MHz)	Occupied Bandwidth (MHz)	
		Chain 0	Chain 1
42	5210	74.64	74.64
58	5290	74.64	74.64
106	5530	74.88	74.88
122	5610	75.60	75.60
138	5690 (For U-NII-2C)	79.88	79.64
138	5690 (For U-NII-3)	7.72	6.28
155	5775	75.96	77.04

Spectrum Plot of Worst Value

802.11a

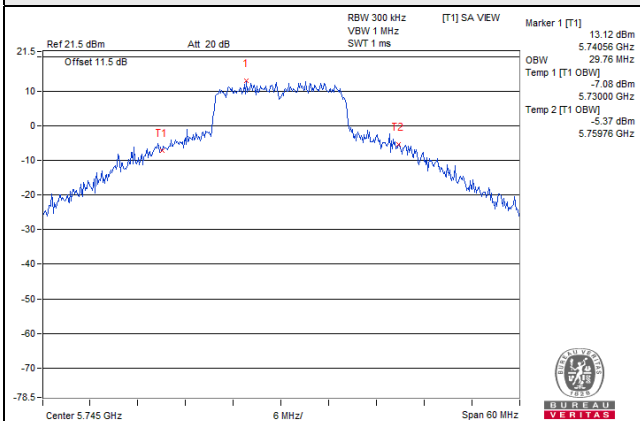

802.11n (HT20)

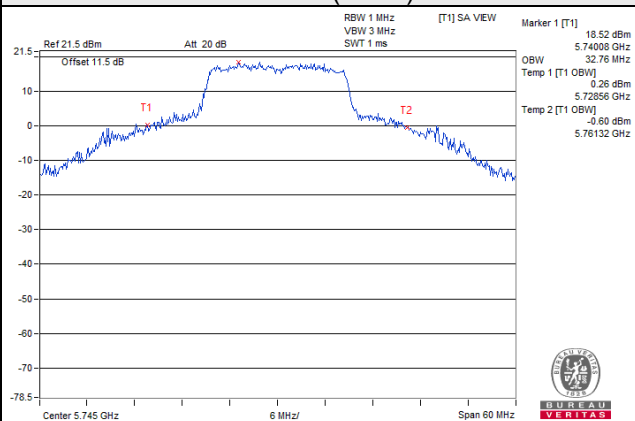

802.11n (HT40)

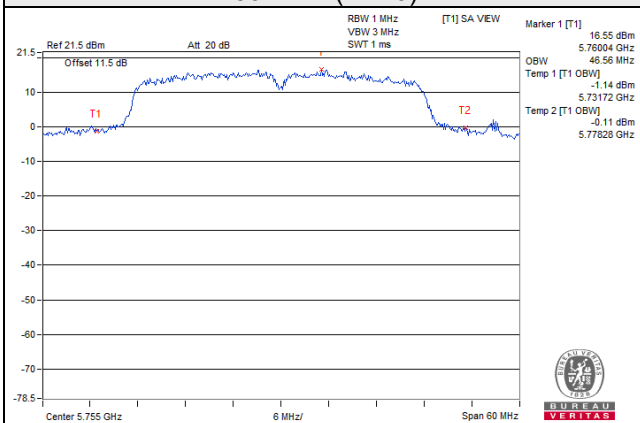

802.11ac (VHT80)

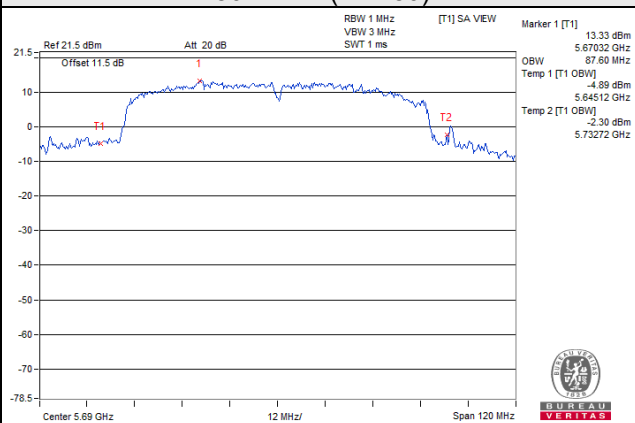

Spectrum Plot for near By DFS Band

802.11a / Chain 0 / CH 48

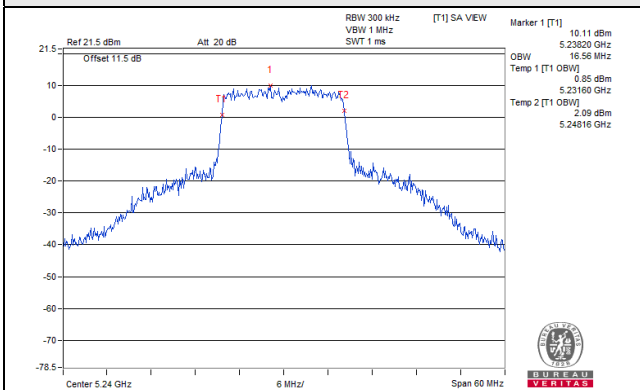

802.11a / Chain 1 / CH 48

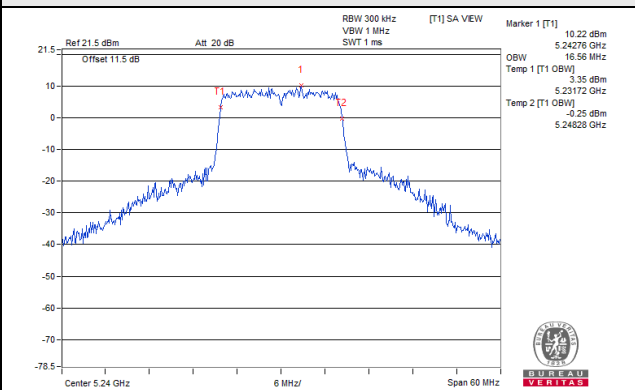

802.11n (HT20) / Chain 0 / CH 48

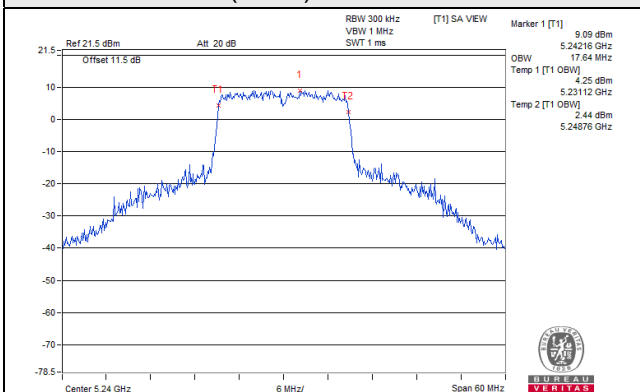

802.11n (HT20) / Chain 1 / CH 48

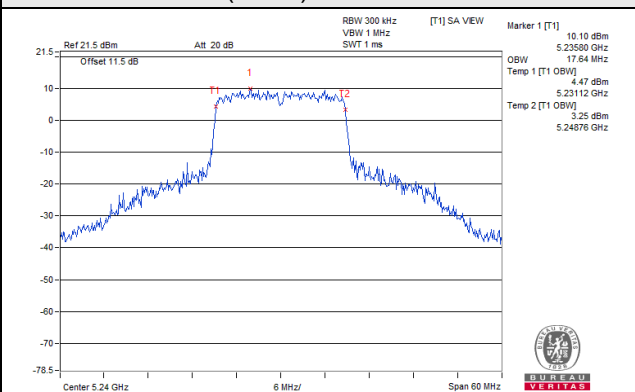

802.11n (HT40) / Chain 0 / CH 46

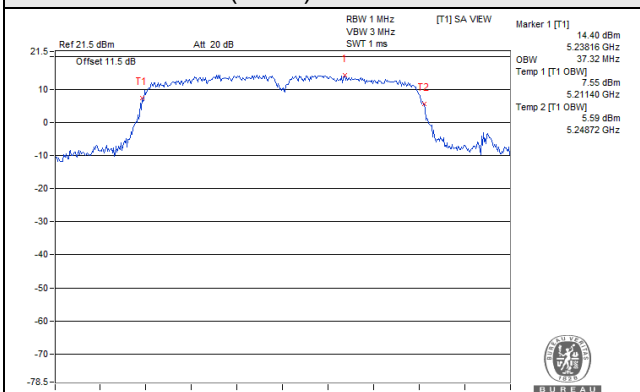

802.11n (HT40) / Chain 1 / CH 46

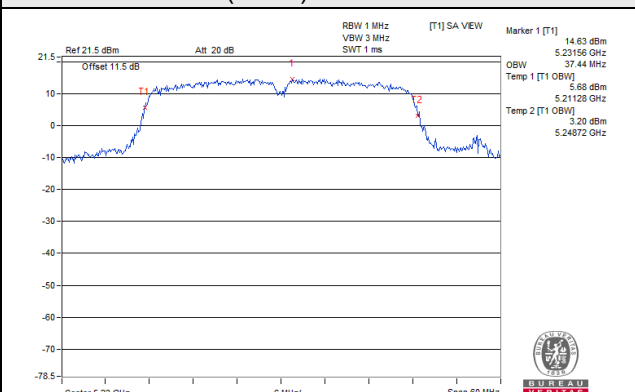

802.11ac (VHT80) / Chain 0 / CH 42

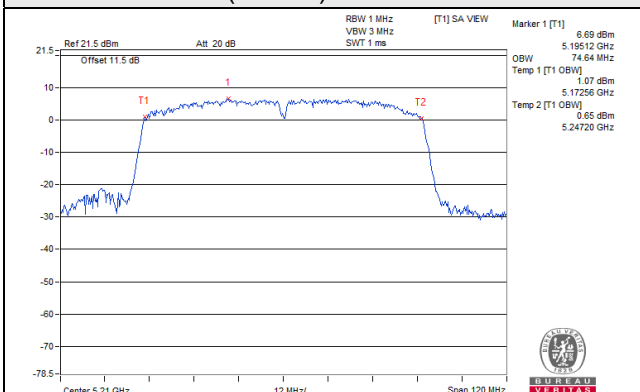

802.11ac (VHT80) / Chain 1 / CH 42

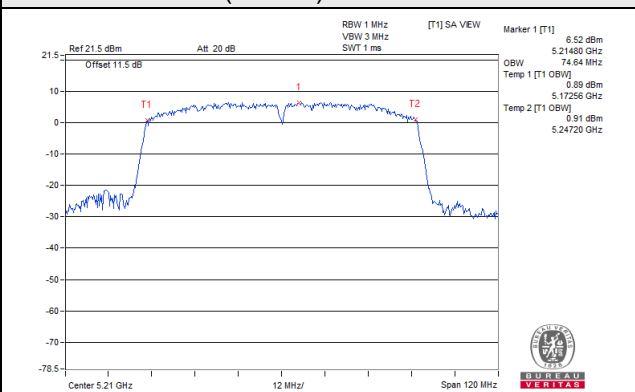

Spectrum Plot for near By DFS Band

802.11a / Chain 0 / CH 149

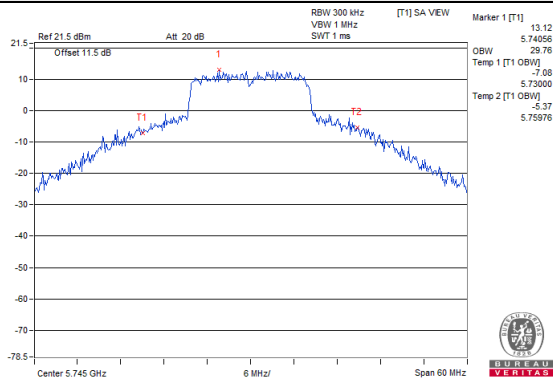

802.11a / Chain 1 / CH 149

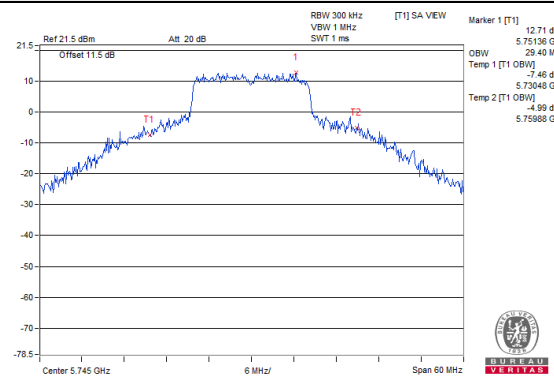

802.11n (HT20) / Chain 0 / CH 149

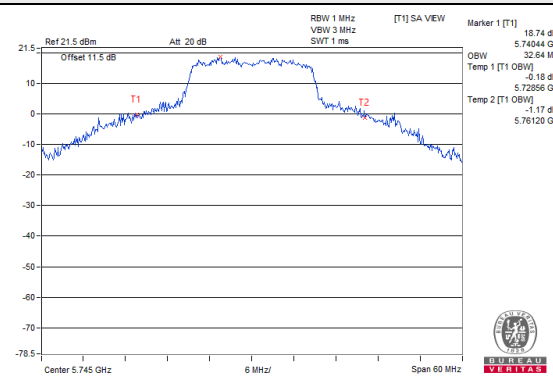

802.11n (HT20) / Chain 1 / CH 149

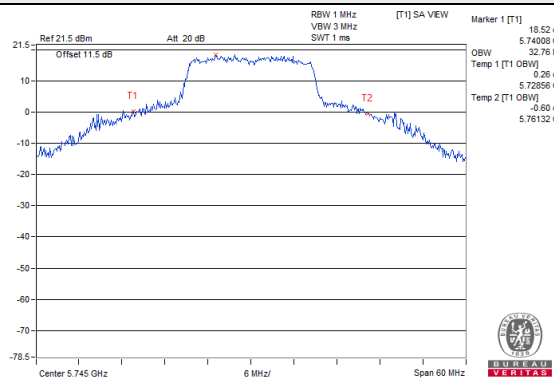

802.11n (HT40) / Chain 0 / CH 151

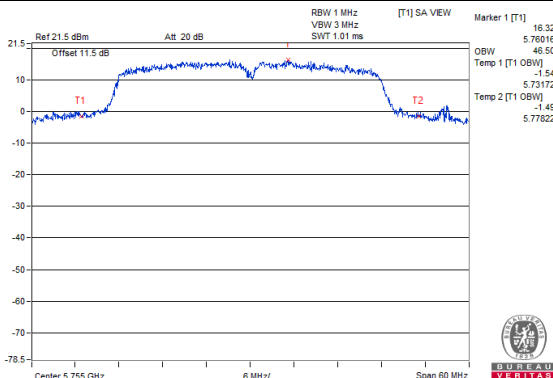

802.11n (HT40) / Chain 1 / CH 151

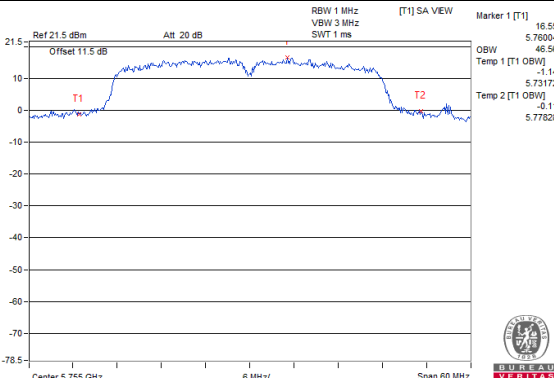

802.11ac (VHT80) / Chain 0 / CH 155

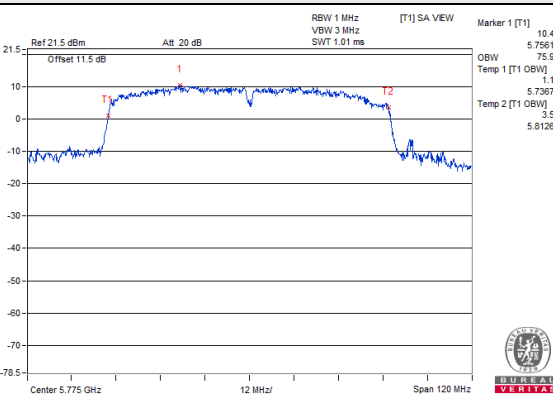

802.11ac (VHT80) / Chain 1 / CH 155

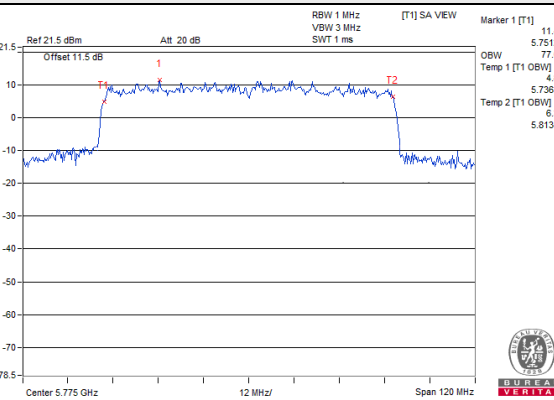

Spectrum Plot

802.11a / Chain 0 / CH 144

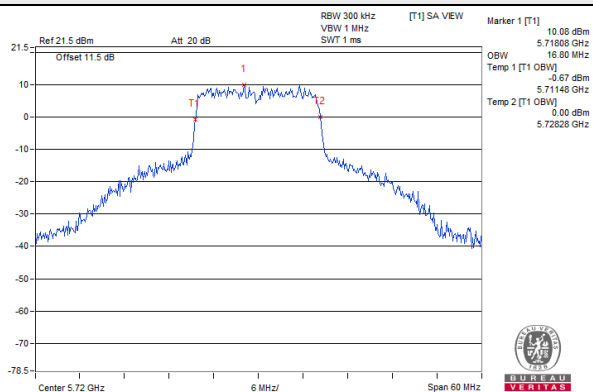

802.11a / Chain 1 / CH 144

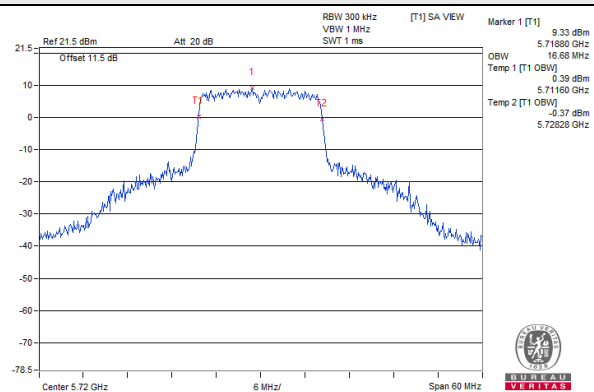

802.11n (HT20) / Chain 0 / CH 144

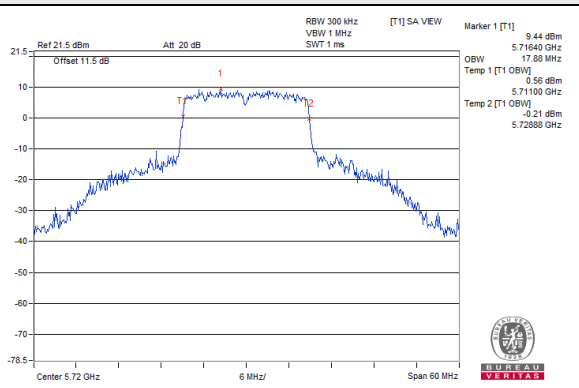

802.11n (HT20) / Chain 1 / CH 144

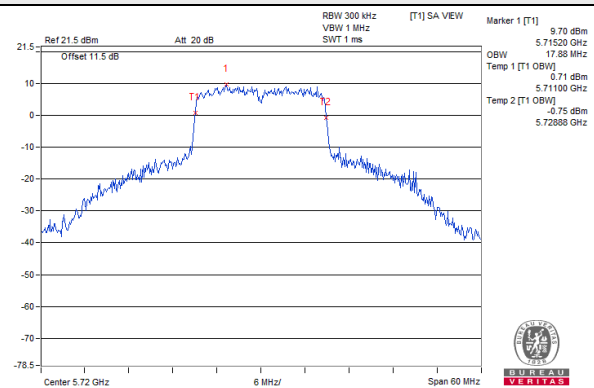

802.11n (HT40) / Chain 0 / CH 142

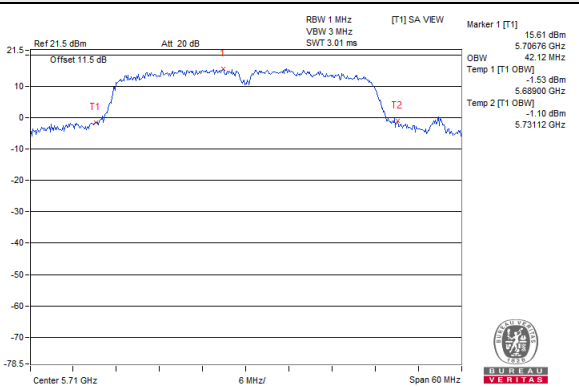

802.11n (HT40) / Chain 1 / CH 142

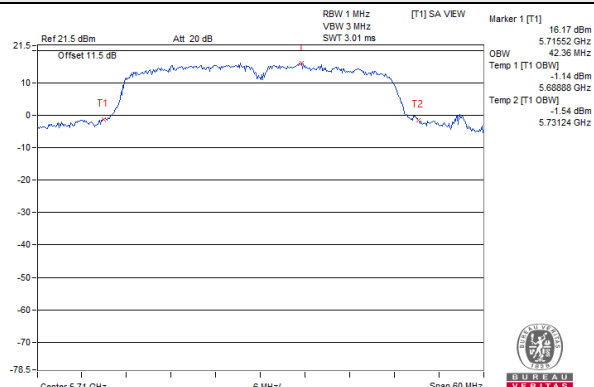

802.11ac (VHT80) / Chain 0 / CH 138

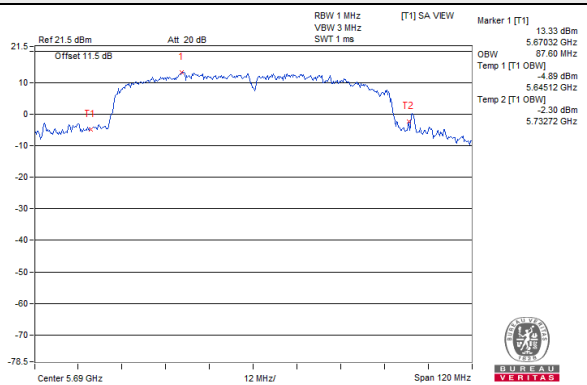

802.11ac (VHT80) / Chain 1 / CH 138

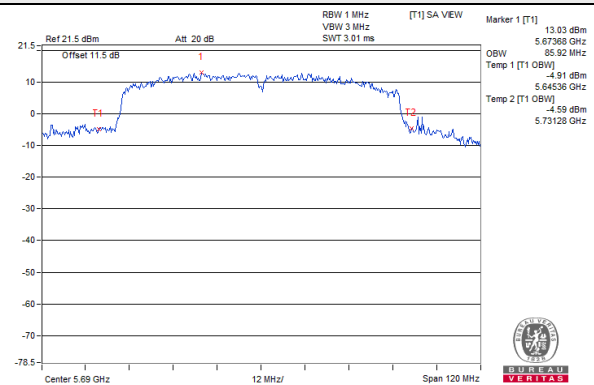

4.5 Peak Power Spectral Density Measurement

4.5.1 Limits of Peak Power Spectral Density Measurement

Operation Band	EUT Category		Limit
U-NII-1		Outdoor Access Point	17dBm/ MHz
		Fixed point-to-point Access Point	
		Indoor Access Point	
	√	Mobile and Portable client device	11dBm/ MHz
U-NII-2A	√		11dBm/ MHz
U-NII-2C	√		11dBm/ MHz
U-NII-3	√		30dBm/ 500kHz

4.5.2 Test Setup

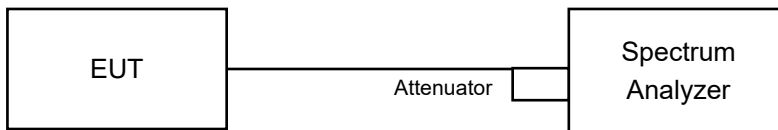

4.5.3 Test Instruments

Refer to section 4.1.2 to get information of above instrument.

4.5.4 Test Procedures

For U-NII-1, U-NII-2A and U-NII-2C band:

Duty cycle of test signal is > 98%

Using method SA-1

- Set span to encompass the entire emission bandwidth (EBW) of the signal.
- Set RBW = 1 MHz, Set VBW ≥ 3 MHz, Detector = RMS
- Sweep time = auto, trigger set to "free run".
- Trace average at least 100 traces in power averaging mode.
- Record the max value

Duty cycle of test signal is < 98%

Using method SA-2

- Set span to encompass the entire emission bandwidth (EBW) of the signal.
- Set RBW = 1MHz, Set VBW ≥ 3 MHz, Detector = RMS
- Set Channel power measure = 1MHz
- Sweep time = auto, trigger set to "free run".
- Trace average at least 100 traces in power averaging mode.
- Record the max value and add 10 log (1/duty cycle)

For U-NII-3 band:

Duty cycle of test signal is > 98%

- a. Set span to encompass the entire emission bandwidth (EBW) of the signal.
- b. Set RBW = 300 kHz, Set VBW \geq 1 MHz, Detector = RMS
- c. Use the peak marker function to determine the maximum power level in any 300 kHz band segment within the fundamental EBW.
- d. Scale the observed power level to an equivalent value in 500 kHz by adjusting (increasing) the measured power by a bandwidth correction factor (BWCF) where $BWCF = 10\log(500 \text{ kHz}/300\text{kHz})$
- e. Sweep time = auto, trigger set to "free run".
- f. Trace average at least 100 traces in power averaging mode.
- g. Record the max value

Duty cycle of test signal is < 98%

- a. Set span to encompass the entire emission bandwidth (EBW) of the signal.
- b. Set RBW = 300 kHz, Set VBW \geq 1 MHz, Detector = RMS
- c. Use the peak marker function to determine the maximum power level in any 300 kHz band segment within the fundamental EBW.
- d. Scale the observed power level to an equivalent value in 500 kHz by adjusting (increasing) the measured power by a bandwidth correction factor (BWCF) where $BWCF = 10\log(500 \text{ kHz} / 300 \text{ kHz})$
- e. Sweep time = auto, trigger set to "free run".
- f. Trace average at least 100 traces in power averaging mode.
- g. Record the max value and add $10 \log (1/\text{duty cycle})$

4.5.5 Deviation from Test Standard

No deviation.

4.5.6 EUT Operating Conditions

Same as 4.3.6.

4.5.7 Test Results

For U-NII-1, U-NII-2A and U-NII-2C band:

802.11a

Chan.	Freq. (MHz)	PSD w/o Duty Factor (dBm/MHz)		Total PSD (dBm/MHz)	Max. Limit (dBm/MHz)	Pass / Fail
		Chain 0	Chain 1			
36	5180	5.63	5.68	8.67	8.81	Pass
40	5200	5.62	5.59	8.62	8.81	Pass
48	5240	5.75	5.75	8.76	8.81	Pass
52	5260	5.53	5.60	8.58	8.81	Pass
60	5300	5.47	5.64	8.57	8.81	Pass
64	5320	5.53	5.74	8.65	8.81	Pass
100	5500	5.51	5.07	8.31	8.81	Pass
116	5580	5.48	5.06	8.29	8.81	Pass
140	5700	5.76	5.33	8.56	8.81	Pass
144	5720 (For U-NII-2C)	5.69	5.40	8.56	8.81	Pass

Note:

- Method E) 2) a) of power density measurement of KDB 662911 is using for calculating total power density. Total power density is summing entire spectra across corresponding frequency bins on the various outputs by computer.
- Directional gain = $10 \log[(10^{G1/10} + 10^{G2/10} + \dots + 10^{GN/10})/N_{ANT}] = 8.19\text{dBi} > 6\text{dBi}$, so the power density limit shall be reduced to $11-(8.19-6) = 8.81\text{dBm}$.

802.11n (HT20)

Chan.	Freq. (MHz)	PSD w/o Duty Factor (dBm/MHz)		Total PSD (dBm/MHz)	Max. Limit (dBm/MHz)	Pass / Fail
		Chain 0	Chain 1			
36	5180	5.40	5.41	8.42	8.81	Pass
40	5200	5.47	5.54	8.52	8.81	Pass
48	5240	5.58	5.73	8.67	8.81	Pass
52	5260	5.40	5.54	8.48	8.81	Pass
60	5300	5.40	5.56	8.49	8.81	Pass
64	5320	5.42	5.64	8.54	8.81	Pass
100	5500	5.22	4.79	8.02	8.81	Pass
116	5580	5.35	5.36	8.37	8.81	Pass
140	5700	5.28	5.33	8.32	8.81	Pass
144	5720 (For U-NII-2C)	5.60	5.62	8.62	8.81	Pass

Note:

- Method E) 2) a) of power density measurement of KDB 662911 is using for calculating total power density. Total power density is summing entire spectra across corresponding frequency bins on the various outputs by computer.
- Directional gain = $10 \log[(10^{G1/10} + 10^{G2/10} + \dots + 10^{GN/10})/N_{ANT}] = 8.19\text{dBi} > 6\text{dBi}$, so the power density limit shall be reduced to $11-(8.19-6) = 8.81\text{dBm}$.
- Refer to section 3.3 for duty cycle spectrum plot.

802.11n (HT40)

Chan.	Freq. (MHz)	PSD w/o Duty Factor (dBm/MHz)		Duty Factor (dB)	Total PSD with Duty Factor (dBm/MHz)	Max. Limit (dBm/MHz)	Pass / Fail
		Chain 0	Chain 1				
38	5190	0.21	0.29	0.18	3.44	8.81	Pass
46	5230	4.59	4.64	0.18	7.80	8.81	Pass
54	5270	4.52	4.56	0.18	7.73	8.81	Pass
62	5310	0.91	0.84	0.18	4.07	8.81	Pass
102	5510	0.73	0.77	0.18	3.94	8.81	Pass
110	5550	4.52	4.53	0.18	7.71	8.81	Pass
134	5670	4.35	4.34	0.18	7.53	8.81	Pass
142	5710 (For U-NII-2C)	5.37	5.50	0.18	8.62	8.81	Pass

Note:

- Method E) 2) a) of power density measurement of KDB 662911 is using for calculating total power density. Total power density is summing entire spectra across corresponding frequency bins on the various outputs by computer.
- Directional gain = $10 \log[(10^{G1/10} + 10^{G2/10} + \dots + 10^{GN/10})/N_{ANT}] = 8.19\text{dBi} > 6\text{dBi}$, so the power density limit shall be reduced to $11-(8.19-6) = 8.81\text{dBm}$.
- Refer to section 3.3 for duty cycle spectrum plot.

802.11ac (VHT80)

Chan.	Freq. (MHz)	PSD w/o Duty Factor (dBm/MHz)		Duty Factor (dB)	Total PSD with Duty Factor (dBm/MHz)	Max. Limit (dBm/MHz)	Pass / Fail
		Chain 0	Chain 1				
42	5210	-3.34	-3.41	0.39	0.02	8.81	Pass
58	5290	-3.07	-3.08	0.39	0.32	8.81	Pass
106	5530	-5.62	-5.65	0.39	-2.24	8.81	Pass
122	5610	0.96	0.95	0.39	4.35	8.81	Pass
138	5690 (For U-NII-2C)	2.86	2.83	0.39	6.24	8.81	Pass

Note:

- Method E) 2) a) of power density measurement of KDB 662911 is using for calculating total power density. Total power density is summing entire spectra across corresponding frequency bins on the various outputs by computer.
- Directional gain = $10 \log[(10^{G1/10} + 10^{G2/10} + \dots + 10^{GN/10})/N_{ANT}] = 8.19\text{dBi} > 6\text{dBi}$, so the power density limit shall be reduced to $11-(8.19-6) = 8.81\text{dBm}$.
- Refer to section 3.3 for duty cycle spectrum plot.

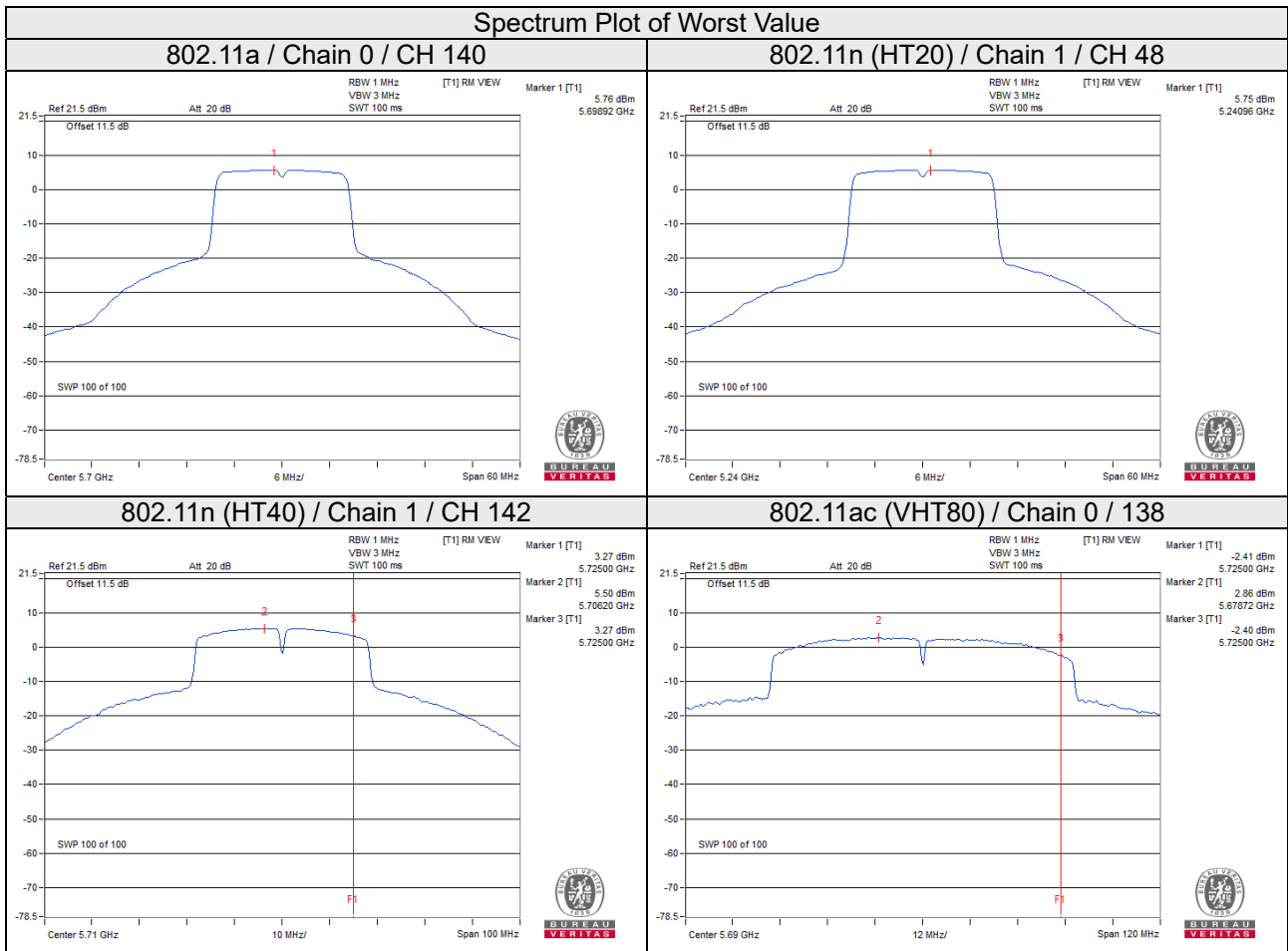

For U-NII-3 band:

802.11a

TX chain	Chan.	Freq. (MHz)	PSD W/O Duty Factor		10 log (N=2) dB	Total PSD (dBm/500 kHz)	Limit (dBm/500kHz)	Pass / Fail
			(dBm/300kHz)	(dBm/500kHz)				
0	144	5720 (For U-NII-3)	-3.37	-1.15	3.01	1.86	27.81	Pass
	149	5745	0.71	2.93	3.01	5.94	27.81	Pass
	157	5785	-0.08	2.14	3.01	5.15	27.81	Pass
	165	5825	-1.03	1.19	3.01	4.20	27.81	Pass
1	144	5720 (For U-NII-3)	-3.47	-1.25	3.01	1.76	27.81	Pass
	149	5745	0.74	2.96	3.01	5.97	27.81	Pass
	157	5785	0.15	2.37	3.01	5.38	27.81	Pass
	165	5825	-0.91	1.31	3.01	4.32	27.81	Pass

Note:

1. Method E) 2) c) of power density measurement of KDB 662911 is using for calculating total power density.
2. Directional gain = $10 \log[(10^{G1/10} + 10^{G2/10} + \dots + 10^{GN/10})/N_{ANT}] = 8.19\text{dBi} > 6\text{dBi}$, so the power density limit shall be reduced to $30-(8.19-6) = 27.81\text{dBm}$.

802.11n (HT20)

TX chain	Chan.	Freq. (MHz)	PSD W/O Duty Factor		10 log (N=2) dB	Total PSD (dBm/500 kHz)	Limit (dBm/500kHz)	Pass / Fail
			(dBm/300kHz)	(dBm/500kHz)				
0	144	5720 (For U-NII-3)	-3.25	-1.03	3.01	1.98	27.81	Pass
	149	5745	0.40	2.62	3.01	5.63	27.81	Pass
	157	5785	-0.31	1.91	3.01	4.92	27.81	Pass
	165	5825	-1.26	0.96	3.01	3.97	27.81	Pass
1	144	5720 (For U-NII-3)	-3.31	-1.09	3.01	1.92	27.81	Pass
	149	5745	0.42	2.64	3.01	5.65	27.81	Pass
	157	5785	-0.31	1.91	3.01	4.92	27.81	Pass
	165	5825	-1.25	0.97	3.01	3.98	27.81	Pass

Note:

1. Method E) 2) c) of power density measurement of KDB 662911 is using for calculating total power density.
2. Directional gain = $10 \log[(10^{G1/10} + 10^{G2/10} + \dots + 10^{GN/10})/N_{ANT}] = 8.19\text{dBi} > 6\text{dBi}$, so the power density limit shall be reduced to $30-(8.19-6) = 27.81\text{dBm}$.

802.11n (HT40)

TX chain	Chan.	Freq. (MHz)	PSD W/O Duty Factor		10 log (N=2) dB	Duty Factor (dB)	Total PSD With Duty Factor (dBm/500kHz)	Limit (dBm/500kHz)	Pass / Fail
			(dBm/300kHz)	(dBm/500kHz)					
0	142	5710 (For U-NII-3)	-5.46	-3.24	3.01	0.18	-0.05	27.81	Pass
	151	5755	-2.48	-0.26	3.01	0.18	2.93	27.81	Pass
	159	5795	-3.60	-1.38	3.01	0.18	1.81	27.81	Pass
1	142	5710 (For U-NII-3)	-5.32	-3.10	3.01	0.18	0.09	27.81	Pass
	151	5755	-2.63	-0.41	3.01	0.18	2.78	27.81	Pass
	159	5795	-3.46	-1.24	3.01	0.18	1.95	27.81	Pass

Note:

- Method E) 2) c) of power density measurement of KDB 662911 is using for calculating total power density.
- Directional gain = $10 \log[(10^{G1/10} + 10^{G2/10} + \dots + 10^{GN/10})/N_{ANT}] = 8.19\text{dBi} > 6\text{dBi}$, so the power density limit shall be reduced to $30-(8.19-6) = 27.81\text{dBm}$.
- Refer to section 3.3 for duty cycle spectrum plot.

802.11ac (VHT80)

TX chain	Chan.	Freq. (MHz)	PSD W/O Duty Factor		10 log (N=2) dB	Duty Factor (dB)	Total PSD With Duty Factor (dBm/500kHz)	Limit (dBm/500kHz)	Pass / Fail
			(dBm/300kHz)	(dBm/500kHz)					
0	138	5690 (For U-NII-3)	-10.66	-8.44	3.01	0.39	-5.04	27.81	Pass
	155	5775	-8.38	-6.16	3.01	0.39	-2.76	27.81	Pass
1	138	5690 (For U-NII-3)	-10.72	-8.50	3.01	0.39	-5.10	27.81	Pass
	155	5775	-8.40	-6.18	3.01	0.39	-2.78	27.81	Pass

Note:

- Method E) 2) c) of power density measurement of KDB 662911 is using for calculating total power density.
- Directional gain = $10 \log[(10^{G1/10} + 10^{G2/10} + \dots + 10^{GN/10})/N_{ANT}] = 8.19\text{dBi} > 6\text{dBi}$, so the power density limit shall be reduced to $30-(8.19-6) = 27.81\text{dBm}$.
- Refer to section 3.3 for duty cycle spectrum plot.

Spectrum Plot of Worst Value

802.11a

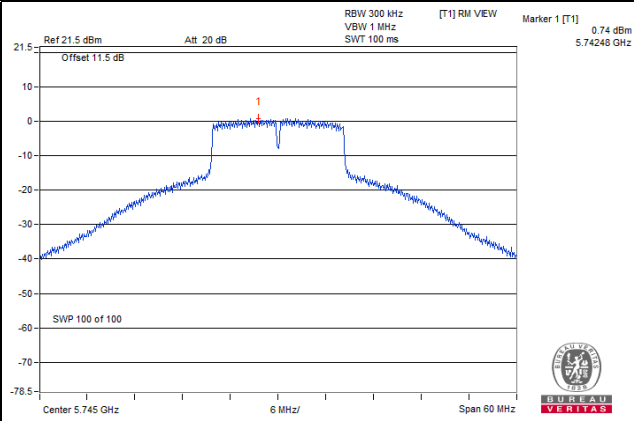

802.11n (HT20)

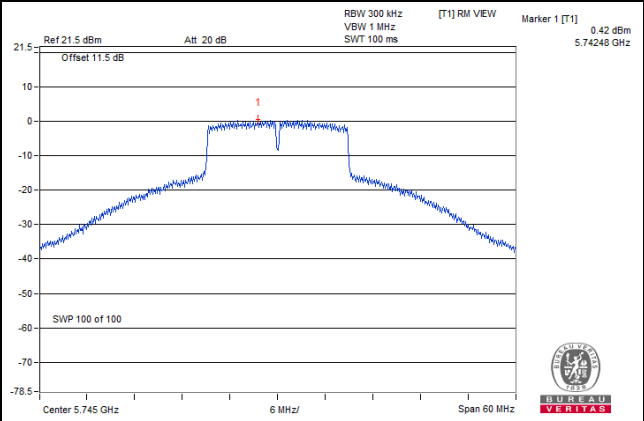

802.11n (HT40)

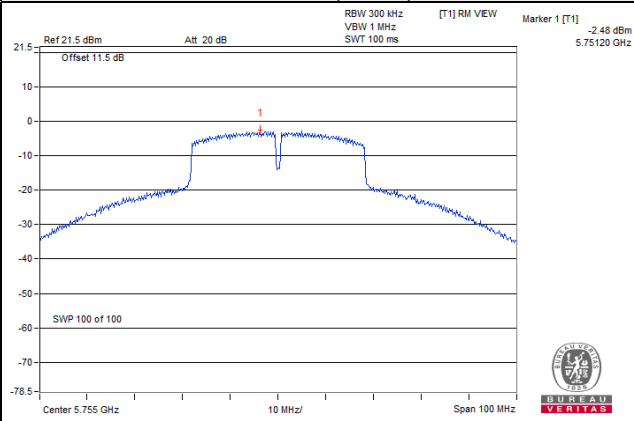

802.11ac (VHT80)

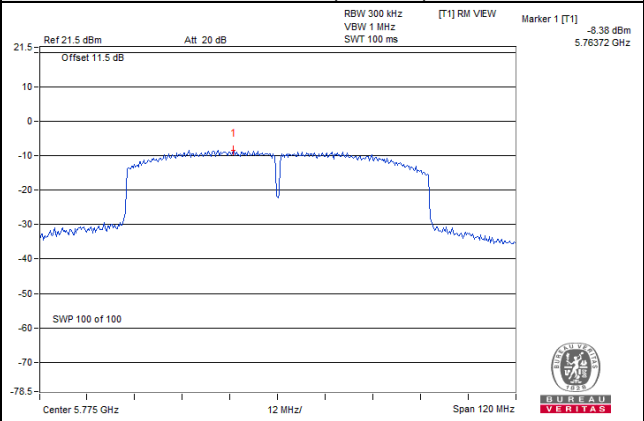

4.6 Frequency Stability

4.6.1 Limits of Frequency Stability Measurement

The frequency of the carrier signal shall be maintained within band of operation

4.6.2 Test Setup

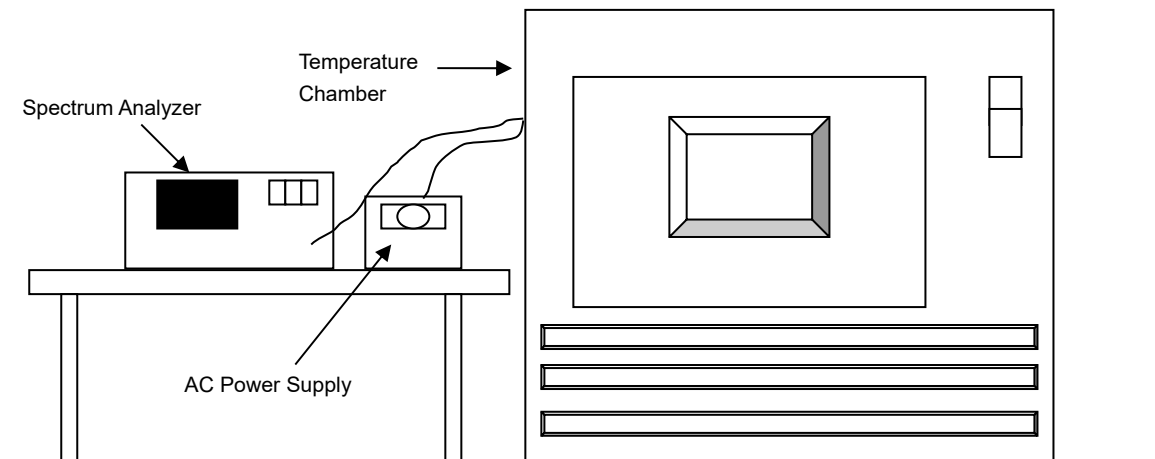

4.6.3 Test Instruments

Description & Manufacturer	Model No.	Serial No.	Cal. Date	Cal. Due
Spectrum Analyzer ROHDE & SCHWARZ	FSP40	100269	Jun. 09, 2020	Jun. 08, 2021
Standard Temperature And Humidity Chamber GIANT FORCE	GTH-120-40-CP-AR	MAA1306-019	Sep. 09, 2020	Sep. 08, 2021
Digital Multimeter Fluke	87-III	70360742	Jun. 23, 2020	Jun. 22, 2021
AC Power Supply Extech	CFW-105	E000603	NA	NA

Note: 1. The calibration interval of the above test instruments is 12 months and the calibrations are traceable to NML/ROC and NIST/USA.

4.6.4 Test Procedure

- The EUT was placed inside the environmental test chamber and powered by nominal AC voltage.
- Turn the EUT on and couple its output to a spectrum analyzer.
- Turn the EUT off and set the chamber to the highest temperature specified.
- Allow sufficient time (approximately 30 min) for the temperature of the chamber to stabilize, turn the EUT on and measure the operating frequency after 2, 5, and 10 minutes.
- Repeat step 2 and 3 with the temperature chamber set to the lowest temperature.
- The test chamber was allowed to stabilize at +20 degree C for a minimum of 30 minutes. The supply voltage was then adjusted on the EUT from 85% to 115% and the frequency record.

4.6.5 Deviation from Test Standard

No deviation.

4.6.6 EUT Operating Condition

Set the EUT transmit at un-modulation mode to test frequency stability.

4.6.7 Test Results

Frequency Stability Versus Temp.									
Operating Frequency: 5180MHz									
Temp. (°C)	Power Supply (Vac)	0 Minute		2 Minute		5 Minute		10 Minute	
		Measured Frequency (MHz)	Result	Measured Frequency (MHz)	Result	Measured Frequency (MHz)	Result	Measured Frequency (MHz)	Result
40	120	5179.9818	PASS	5179.9815	PASS	5179.9833	PASS	5179.9840	PASS
30	120	5180.0078	PASS	5180.0066	PASS	5180.0069	PASS	5180.0052	PASS
20	120	5179.9782	PASS	5179.9779	PASS	5179.9740	PASS	5179.9751	PASS
10	120	5179.9890	PASS	5179.9919	PASS	5179.9937	PASS	5179.9904	PASS
0	120	5180.0080	PASS	5180.0093	PASS	5180.0089	PASS	5180.0079	PASS

Frequency Stability Versus Voltage									
Operating Frequency: 5180MHz									
Temp. (°C)	Power Supply (Vac)	0 Minute		2 Minute		5 Minute		10 Minute	
		Measured Frequency (MHz)	Result	Measured Frequency (MHz)	Result	Measured Frequency (MHz)	Result	Measured Frequency (MHz)	Result
20	138	5179.9792	PASS	5179.9784	PASS	5179.9745	PASS	5179.9747	PASS
	120	5179.9782	PASS	5179.9779	PASS	5179.9740	PASS	5179.9751	PASS
	102	5179.9787	PASS	5179.9780	PASS	5179.9738	PASS	5179.9749	PASS

4.7 6dB Bandwidth Measurement

4.7.1 Limits of 6dB Bandwidth Measurement

The minimum of 6dB Bandwidth Measurement is 0.5MHz.

4.7.2 Test Setup

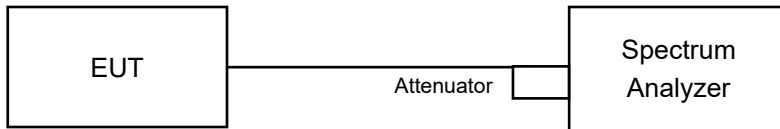

4.7.3 Test Instruments

Refer to section 4.1.2 to get information of above instrument.

4.7.4 Test Procedure

- Set resolution bandwidth (RBW) = 100kHz
- Set the video bandwidth (VBW) $\geq 3 \times$ RBW, Detector = Peak.
- Trace mode = max hold.
- Sweep = auto couple.
- Measure the maximum width of the emission that is constrained by the frequencies associated with the two amplitude points (upper and lower) that are attenuated by 6 dB relative to the maximum level measured in the fundamental emission

4.7.5 Deviation from Test Standard

No deviation.

4.7.6 EUT Operating Condition

The software provided by client to enable the EUT under transmission condition continuously at lowest, middle and highest channel frequencies individually.

4.7.7 Test Results

802.11a

Channel	Frequency (MHz)	6dB Bandwidth (MHz)		Minimum Limit (MHz)	Pass / Fail
		Chain 0	Chain 1		
144	5720 (For U-NII-3)	3.15	3.15	0.5	Pass
149	5745	15.98	16.35	0.5	Pass
157	5785	15.99	16.36	0.5	Pass
165	5825	15.99	16.11	0.5	Pass

802.11n (HT20)

Channel	Frequency (MHz)	6dB Bandwidth (MHz)		Minimum Limit (MHz)	Pass / Fail
		Chain 0	Chain 1		
144	5720 (For U-NII-3)	3.53	3.52	0.5	Pass
149	5745	17.21	16.87	0.5	Pass
157	5785	16.87	16.87	0.5	Pass
165	5825	16.88	16.88	0.5	Pass

802.11n (HT40)

Channel	Frequency (MHz)	6dB Bandwidth (MHz)		Minimum Limit (MHz)	Pass / Fail
		Chain 0	Chain 1		
142	5710 (For U-NII-3)	2.56	2.50	0.5	Pass
151	5755	35.16	35.17	0.5	Pass
159	5795	35.18	35.16	0.5	Pass

802.11ac (VHT80)

Channel	Frequency (MHz)	6dB Bandwidth (MHz)		Minimum Limit (MHz)	Pass / Fail
		Chain 0	Chain 1		
138	5690 (For U-NII-3)	1.31	1.27	0.5	Pass
155	5775	72.69	72.68	0.5	Pass

Spectrum Plot of Worst Value

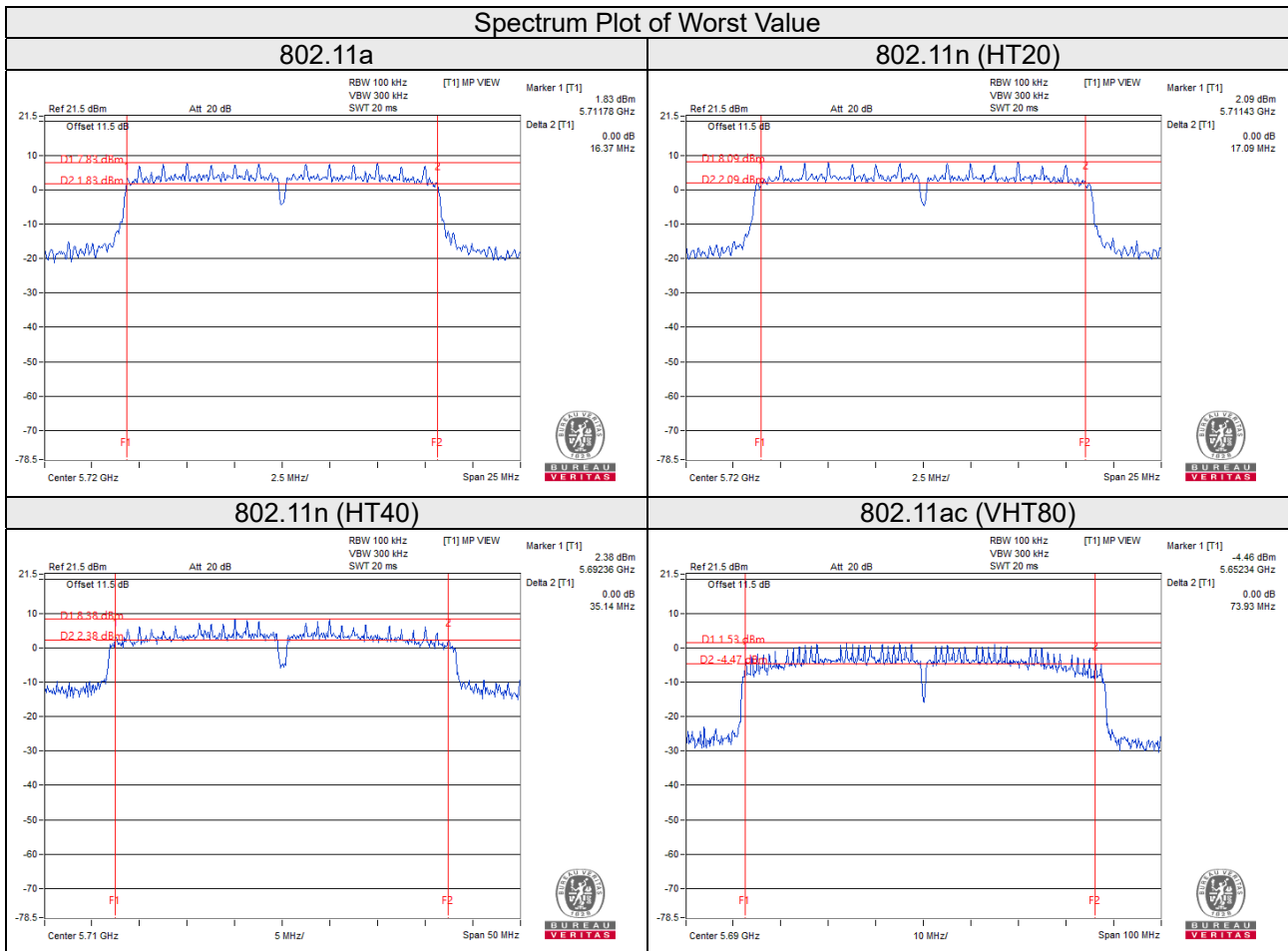

Note:

For CH144 (UNII-3 Band): The 6dB bandwidth above 5725MHz = Marker 1 + Delta 2 - 5725MHz

For CH142 (UNII-3 Band): The 6dB bandwidth above 5725MHz = Marker 1 + Delta 2 - 5725MHz

For CH138 (UNII-3 Band): The 6dB bandwidth above 5725MHz = Marker 1 + Delta 2 - 5725MHz

5 Pictures of Test Arrangements

Please refer to the attached file (Test Setup Photo).

Annex A- Radiated out of Band Emission (OOBE) Measurement (For U-NII-3 band)

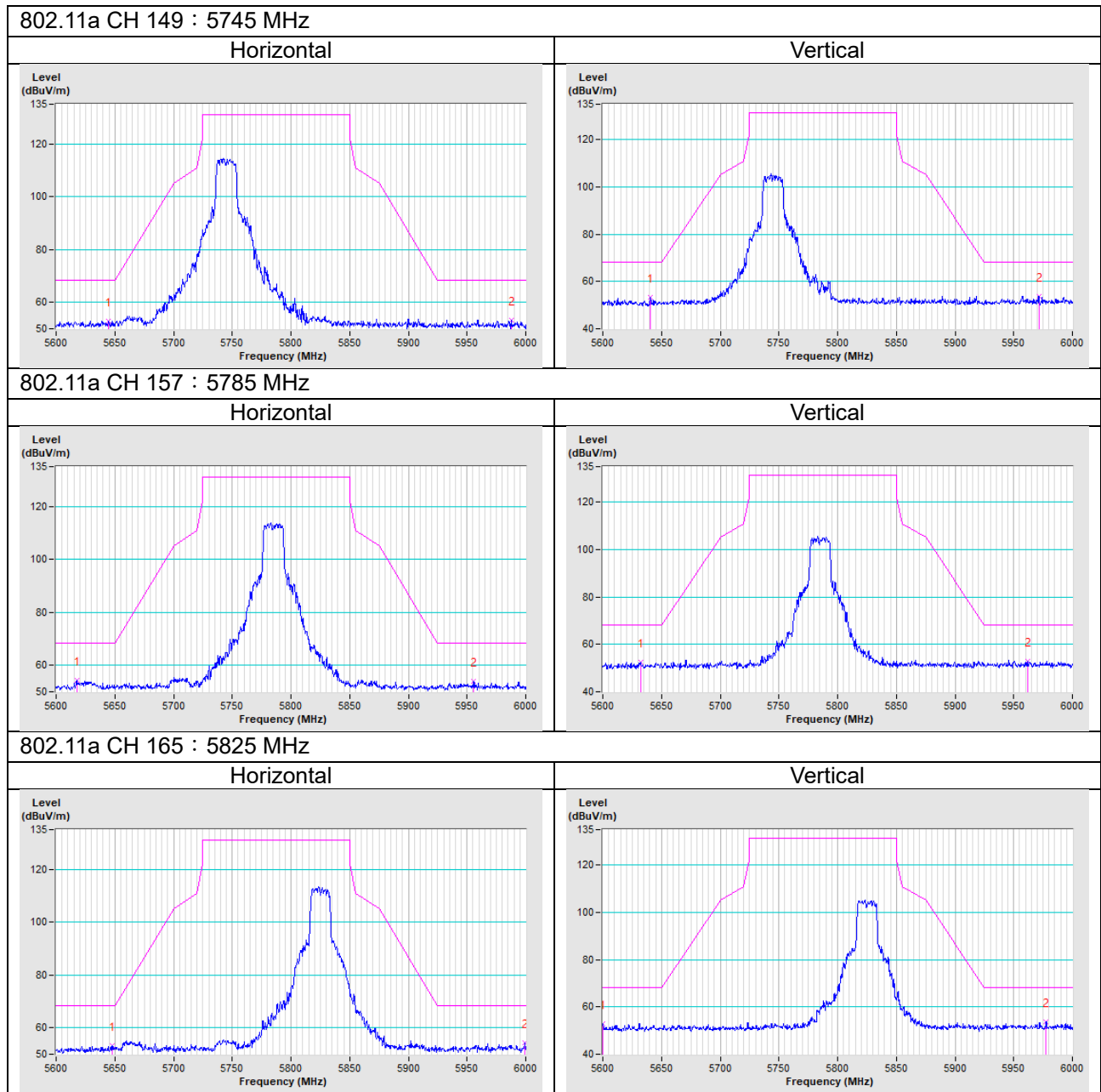

802.11n (HT20) CH 149 : 5745 MHz

Horizontal

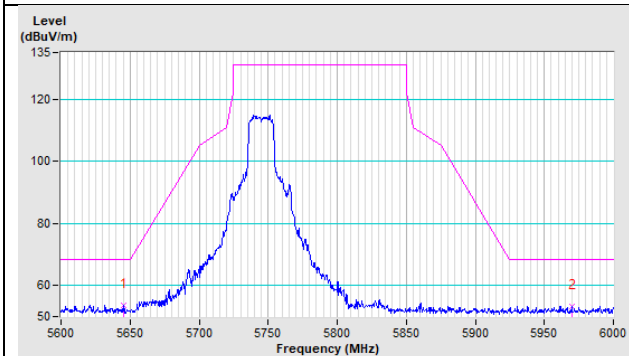

Vertical

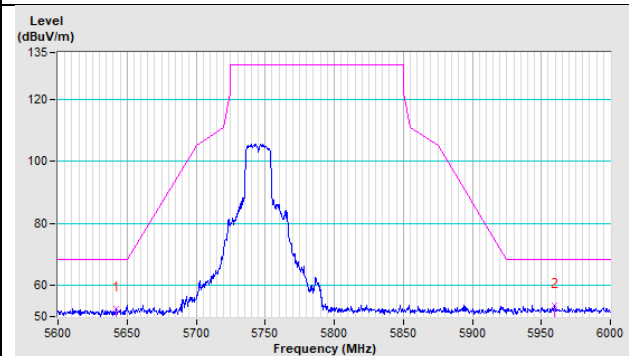

802.11n (HT20) CH 157 : 5785 MHz

Horizontal

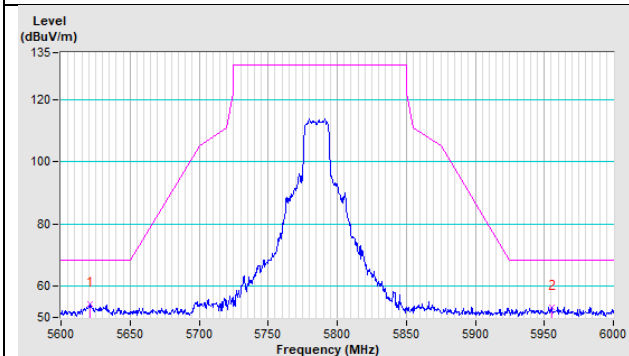

Vertical

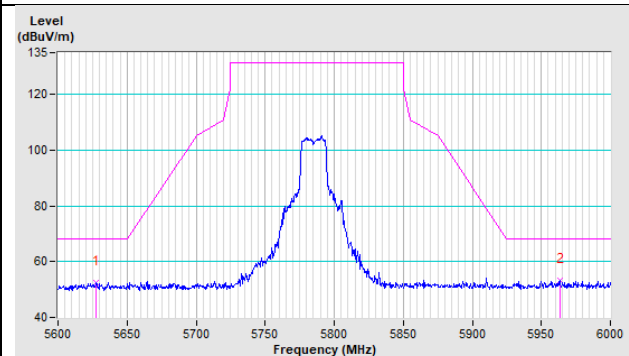

802.11n (HT20) CH 165 : 5825 MHz

Horizontal

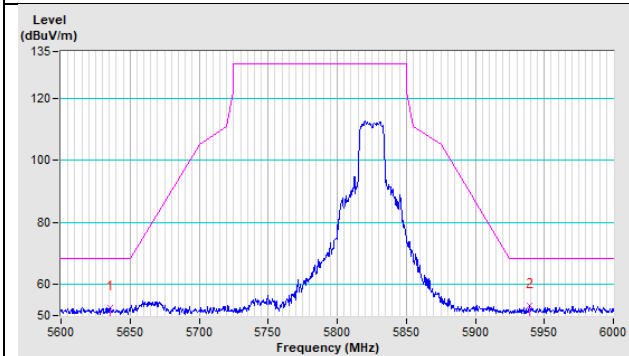

Vertical

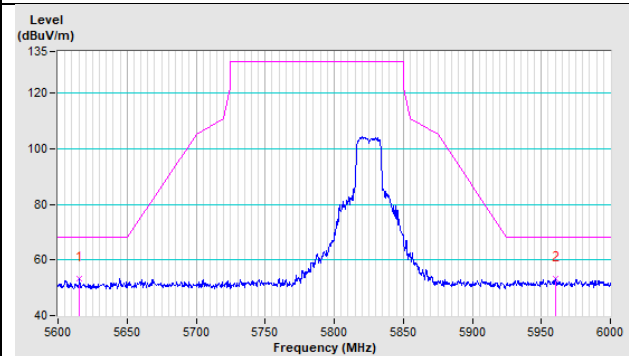

802.11n (HT40) CH 151 : 5755 MHz

Horizontal

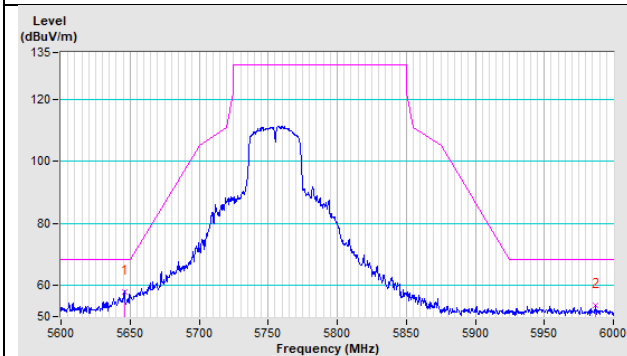

Vertical

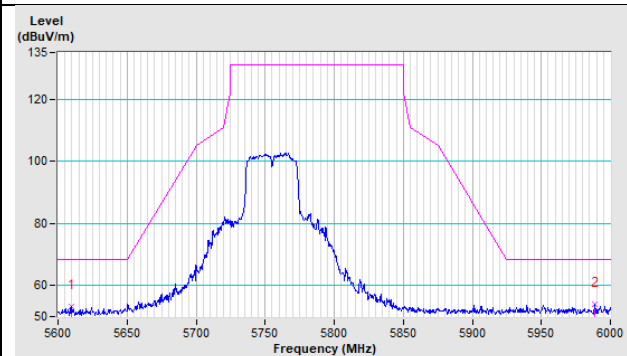

802.11n (HT40) CH 159 : 5795 MHz

Horizontal

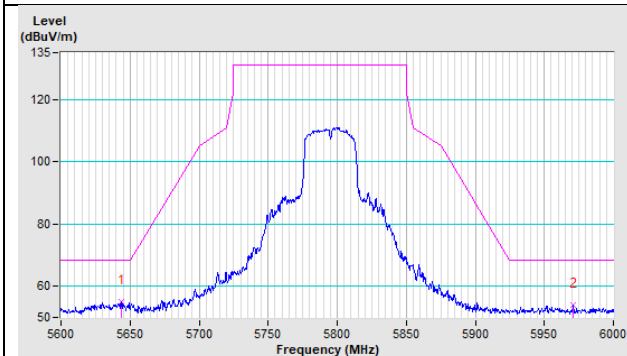

Vertical

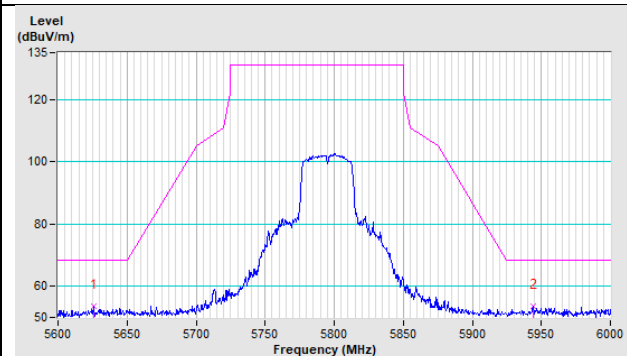

802.11ac (VHT80) CH 155 : 5775 MHz

Horizontal

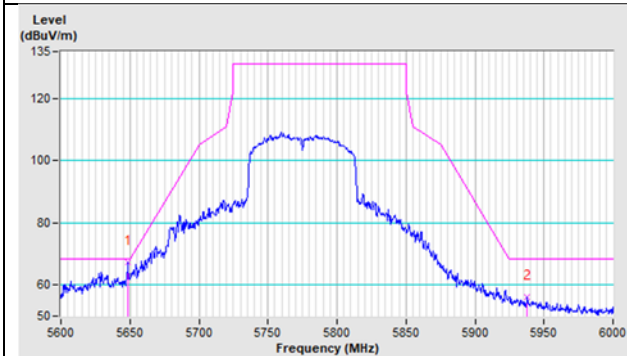

Vertical

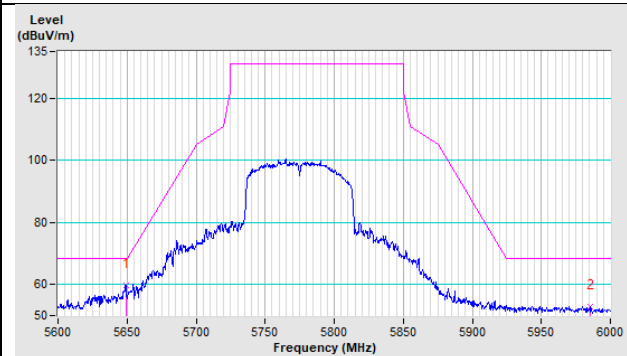

Annex B- Band Edge Measurement

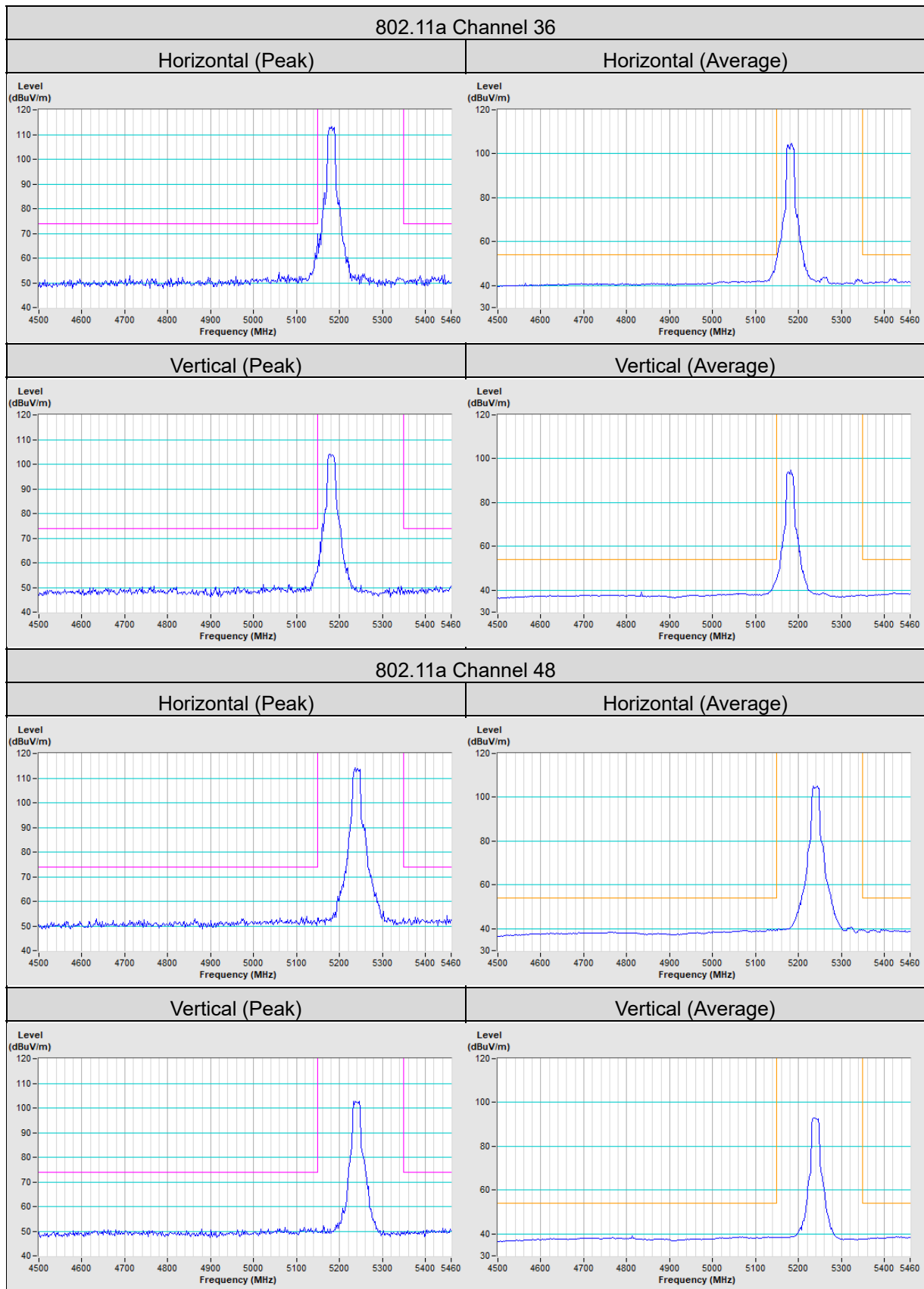

802.11n (HT20) Channel 36

Horizontal (Peak)	Horizontal (Average)
--------------------------	-----------------------------

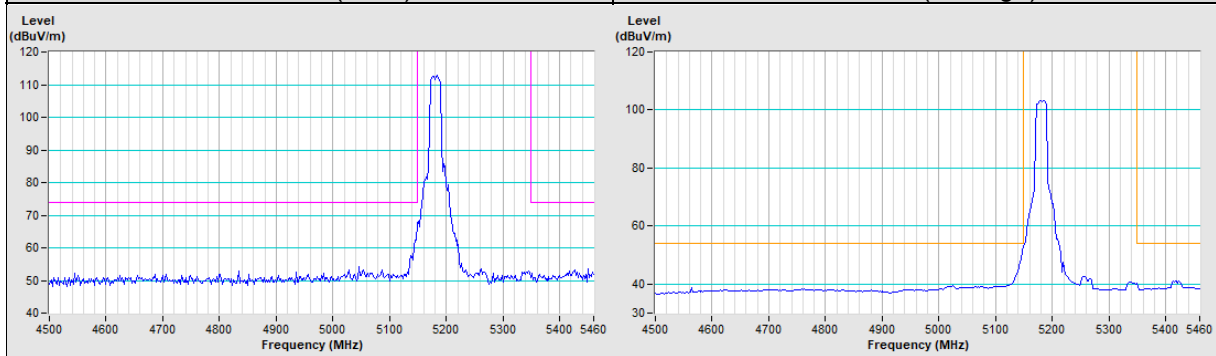

Vertical (Peak)	Vertical (Average)
------------------------	---------------------------

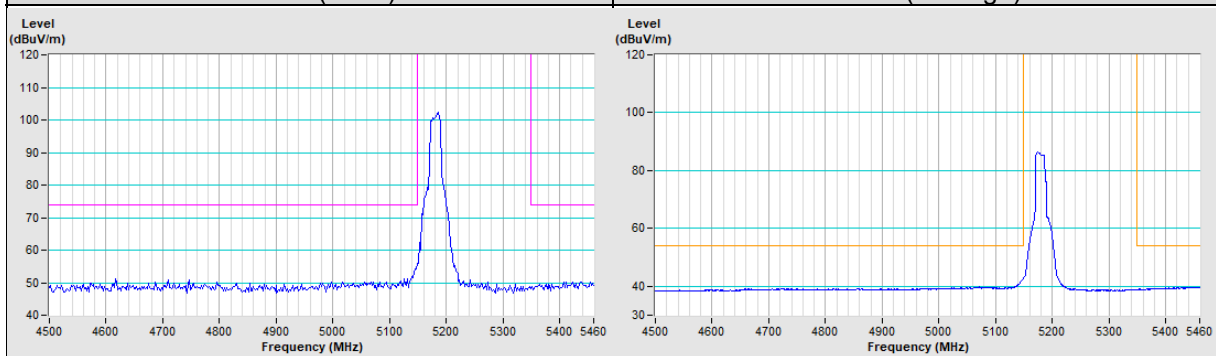

802.11n (HT20) Channel 48

Horizontal (Peak)	Horizontal (Average)
--------------------------	-----------------------------

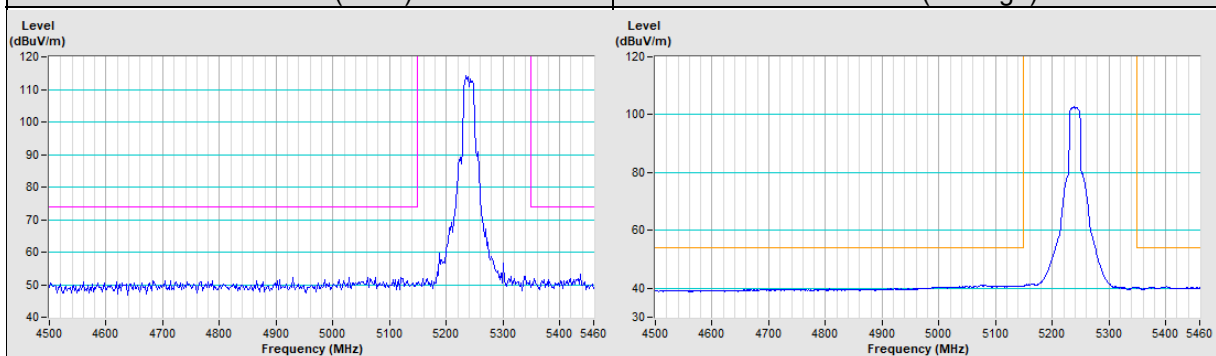

Vertical (Peak)	Vertical (Average)
------------------------	---------------------------

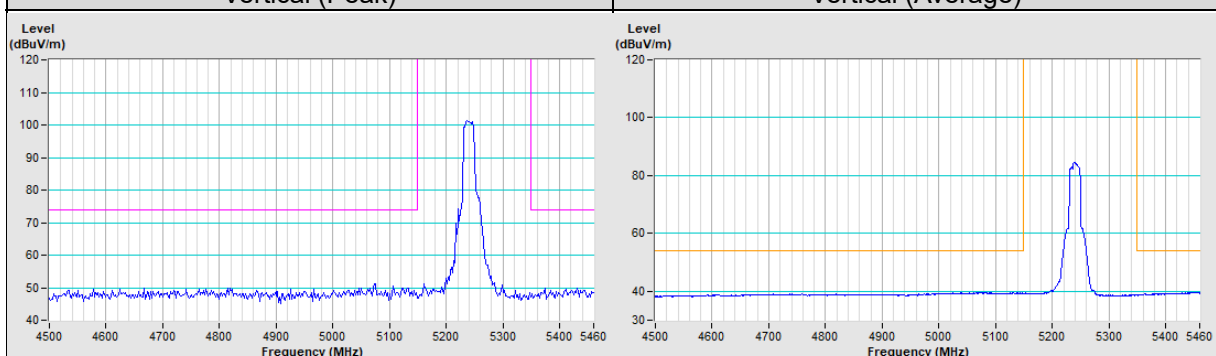

802.11n (HT20) Channel 52

Horizontal (Peak)

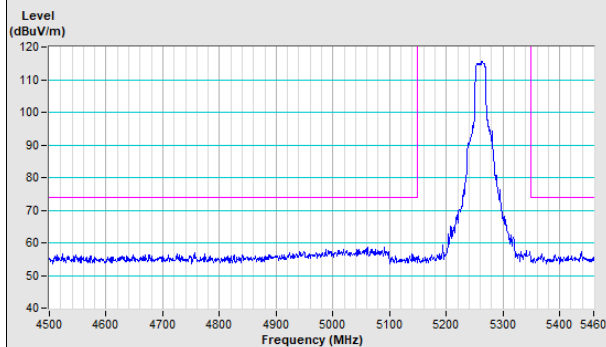

Horizontal (Average)

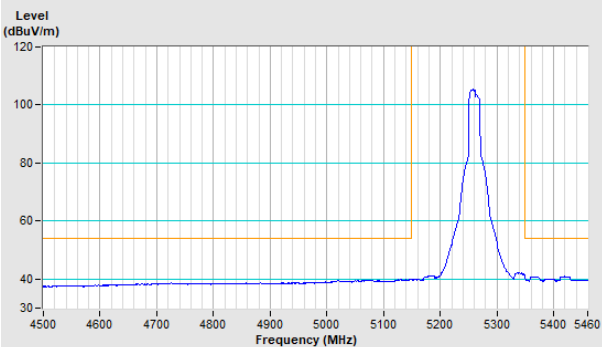

Vertical (Peak)

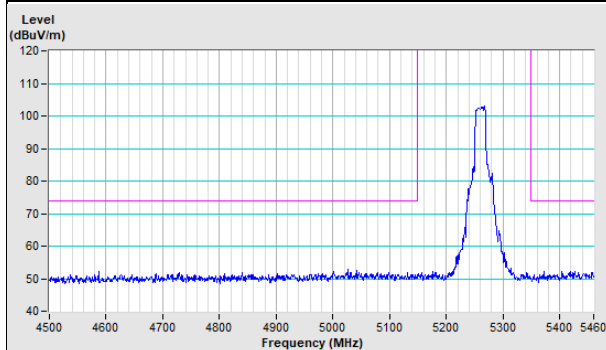

Vertical (Average)

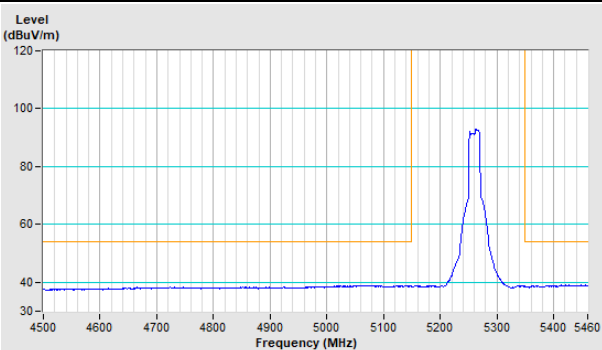

802.11n (HT20) Channel 64

Horizontal (Peak)

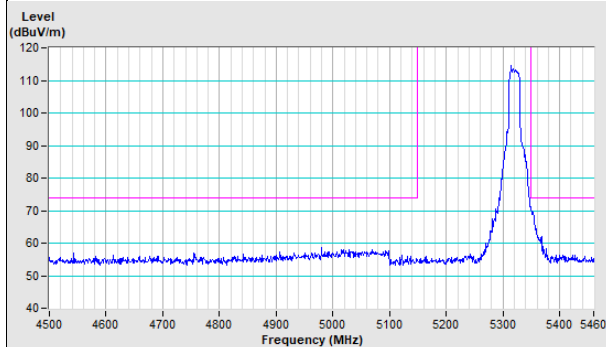

Horizontal (Average)

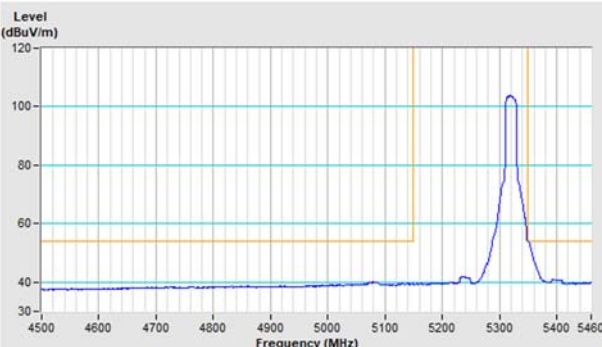

Vertical (Peak)

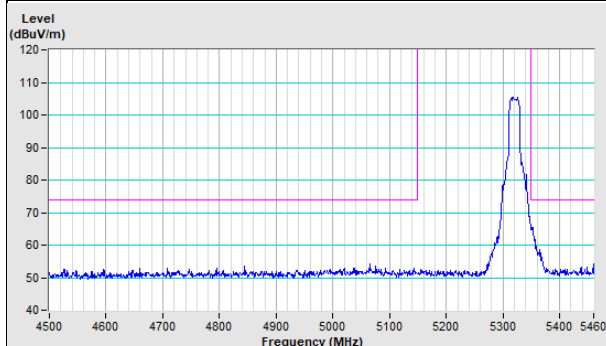

Vertical (Average)

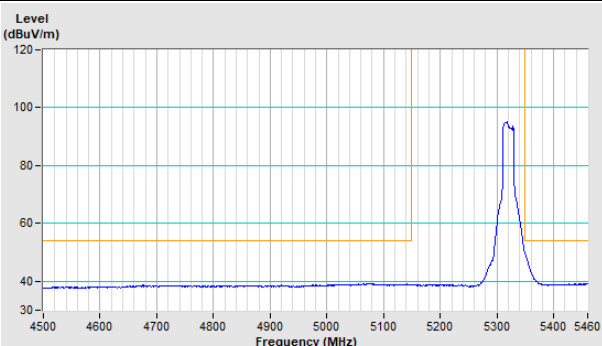

802.11n (HT20) Channel 100

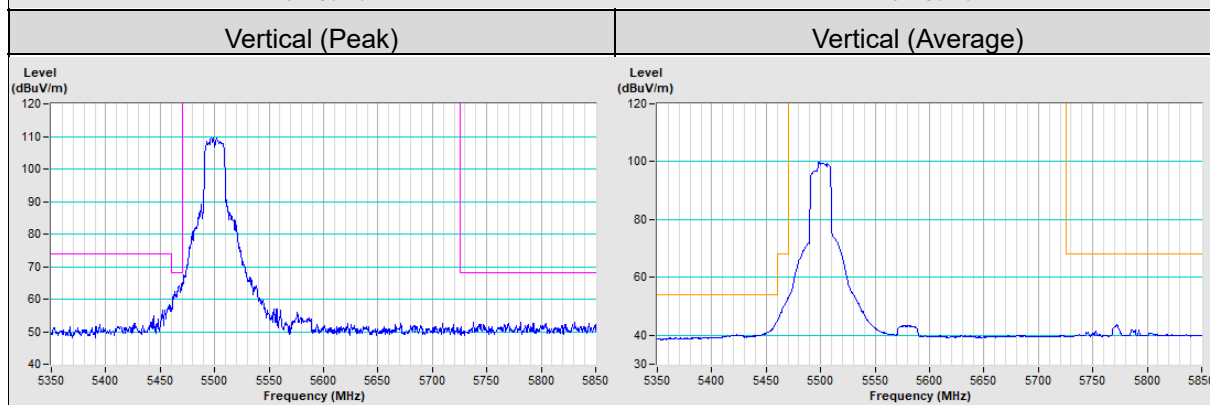
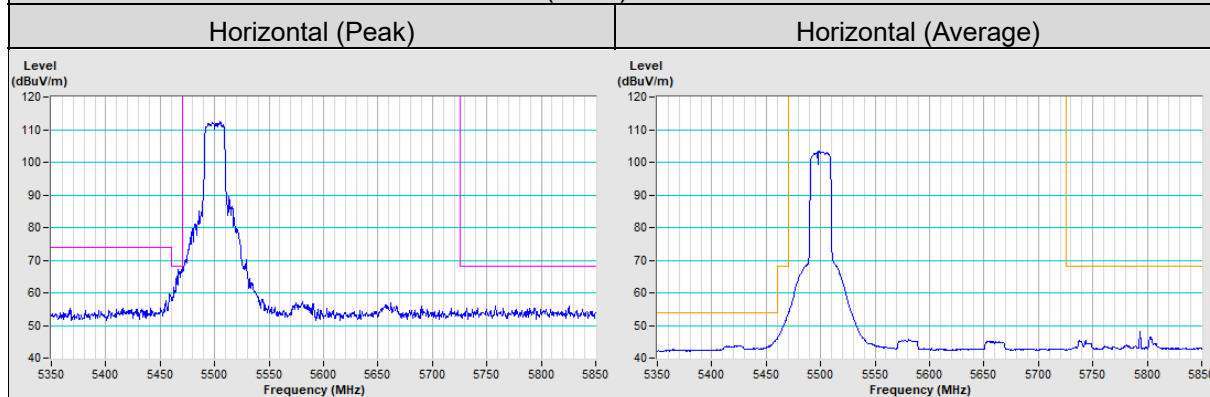

802.11n (HT20) Channel 140

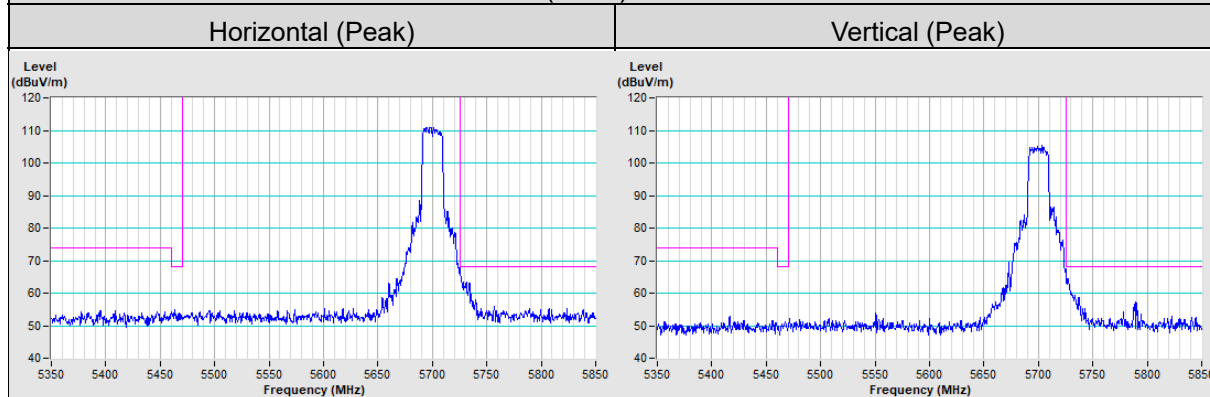

802.11n (HT20) Channel 144

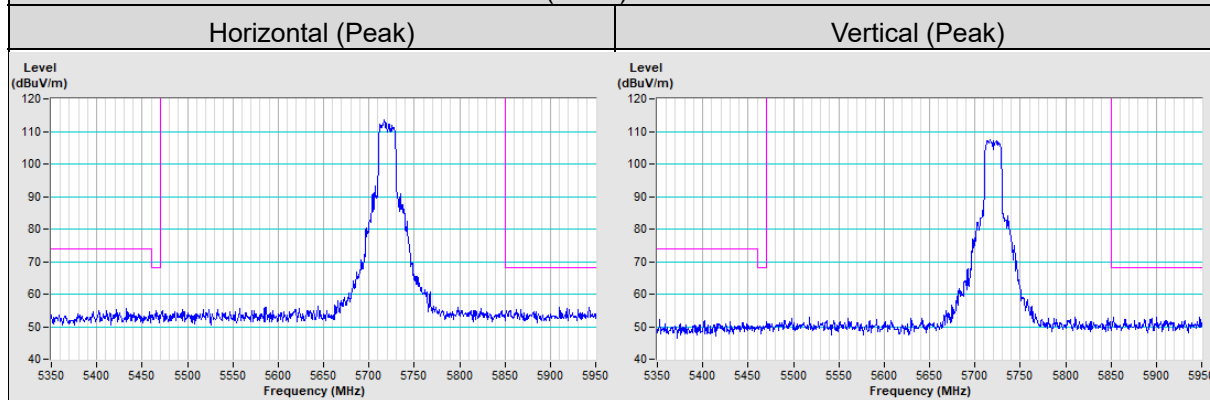

802.11n (HT40) Channel 38

Horizontal (Peak)

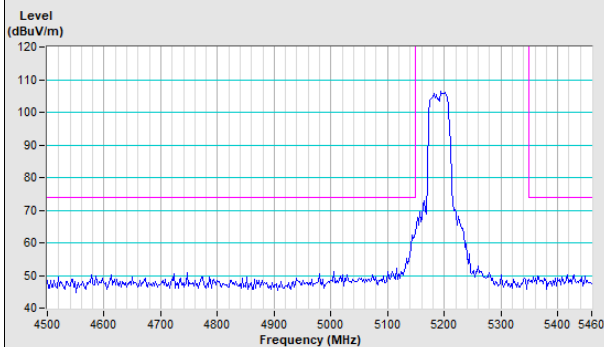

Horizontal (Average)

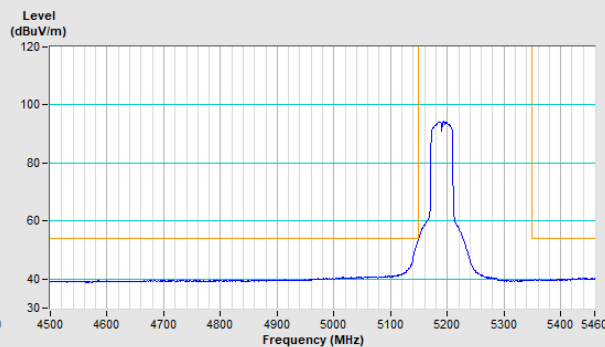

Vertical (Peak)

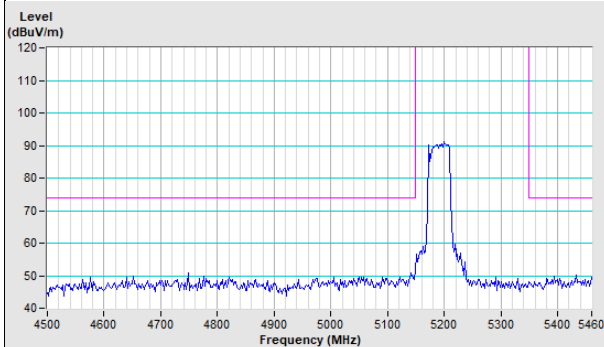

Vertical (Average)

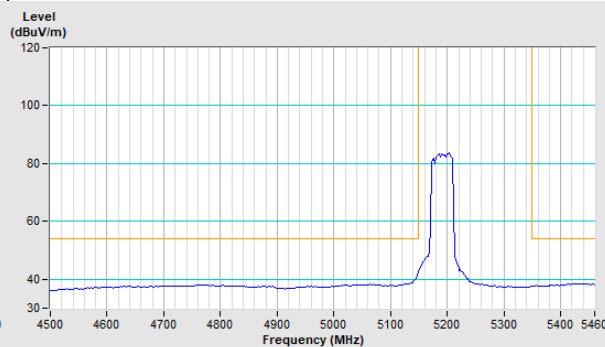

802.11n (HT40) Channel 46

Horizontal (Peak)

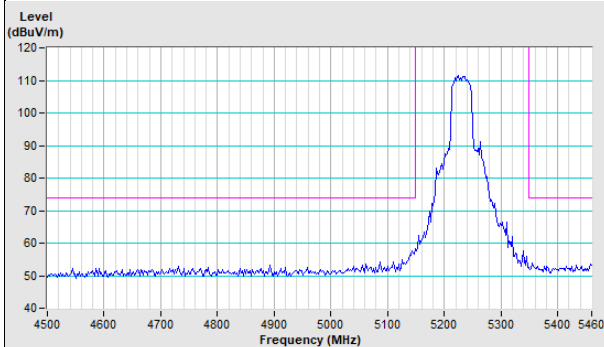

Horizontal (Average)

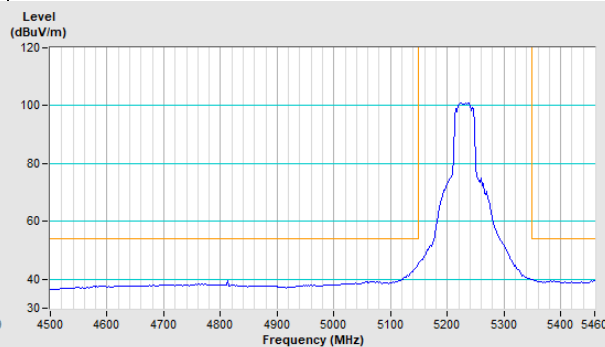

Vertical (Peak)

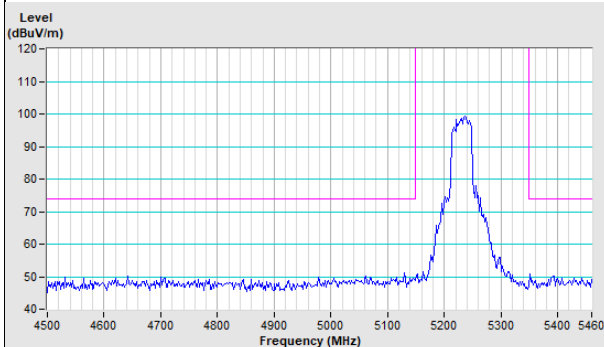

Vertical (Average)

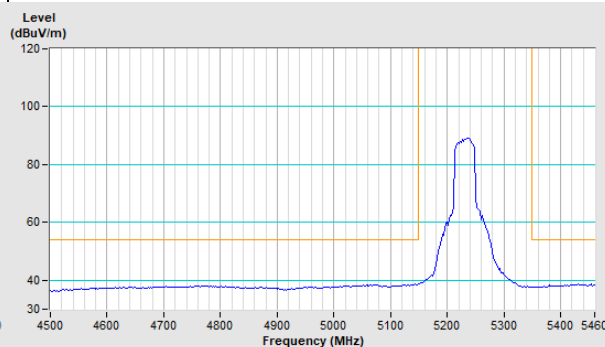

802.11n (HT40) Channel 54

Horizontal (Peak)	Horizontal (Average)
--------------------------	-----------------------------

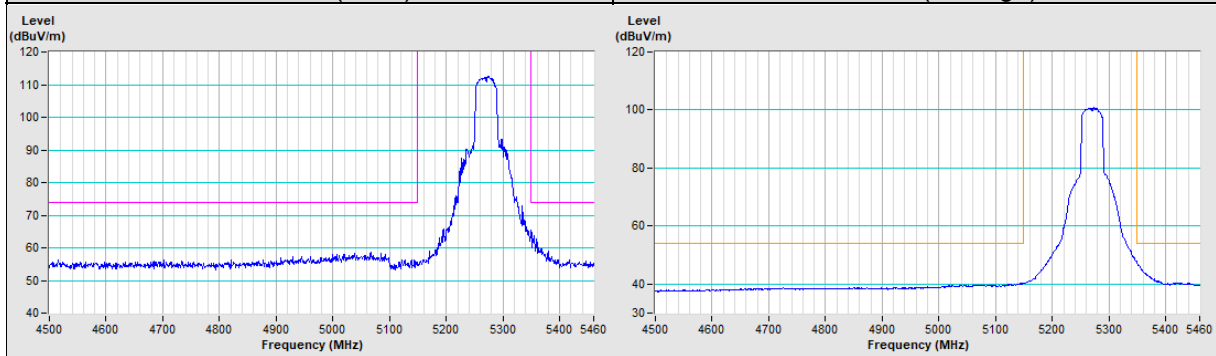

Vertical (Peak)	Vertical (Average)
------------------------	---------------------------

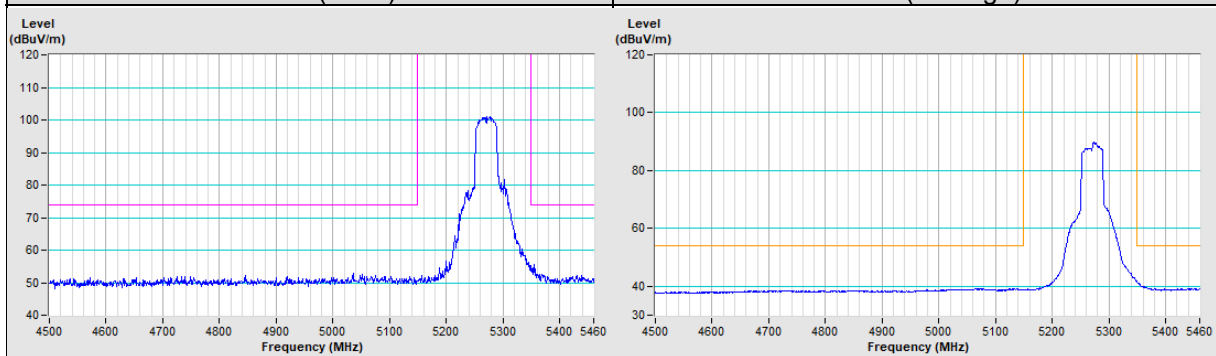

802.11n (HT40) Channel 62

Horizontal (Peak)	Horizontal (Average)
--------------------------	-----------------------------

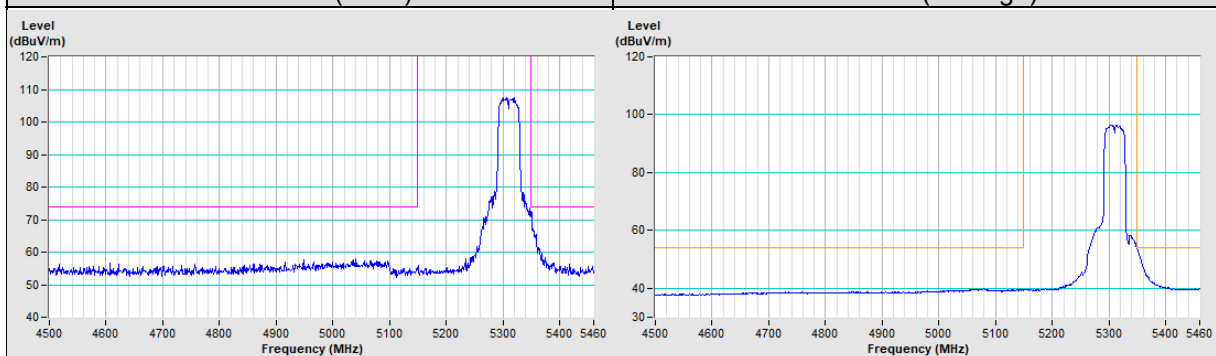

Vertical (Peak)	Vertical (Average)
------------------------	---------------------------

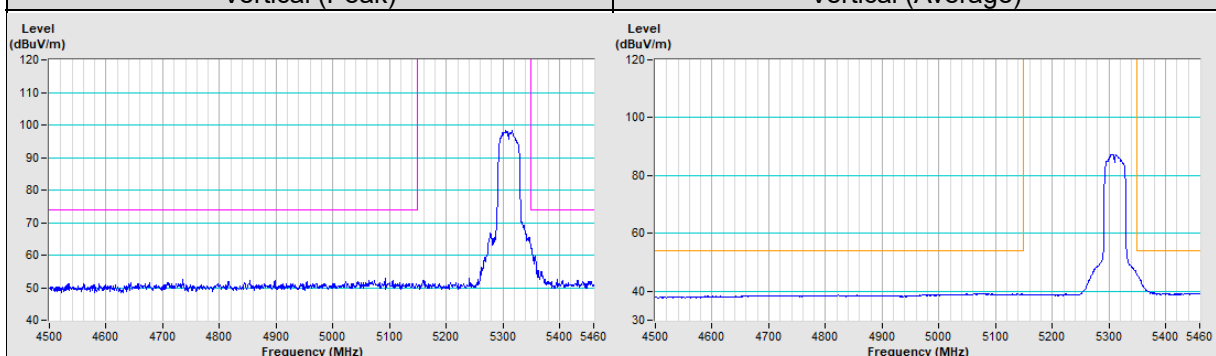

802.11n (HT40) Channel 102

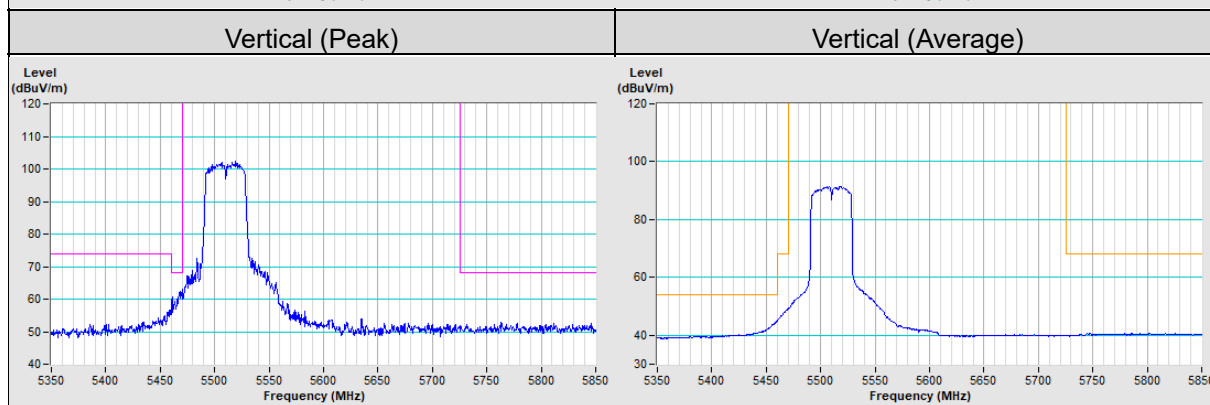
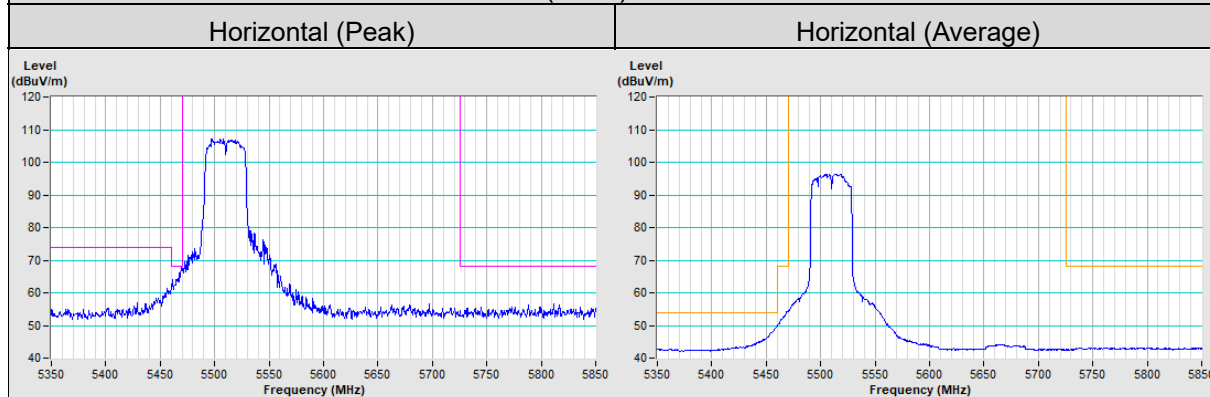

802.11n (HT40) Channel 134

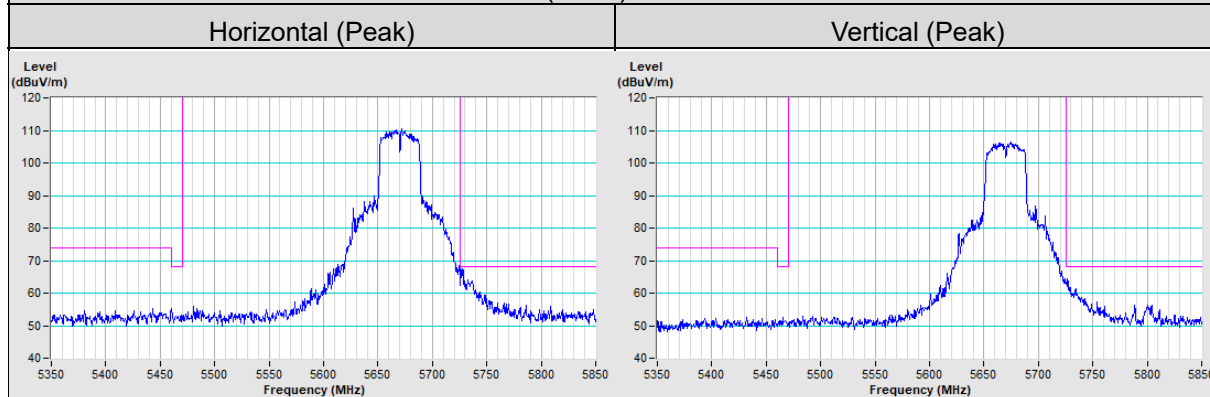

802.11n (HT40) Channel 142

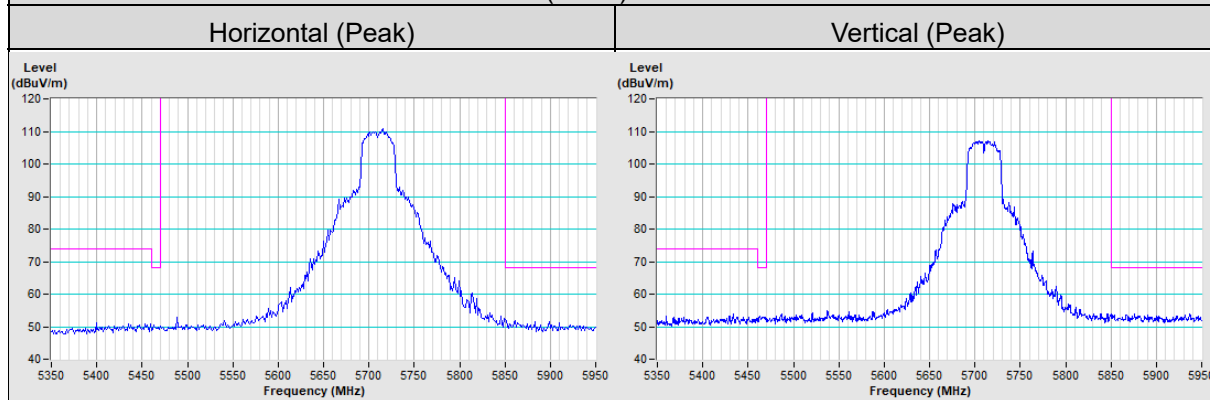

802.11ac (VHT80) Channel 106

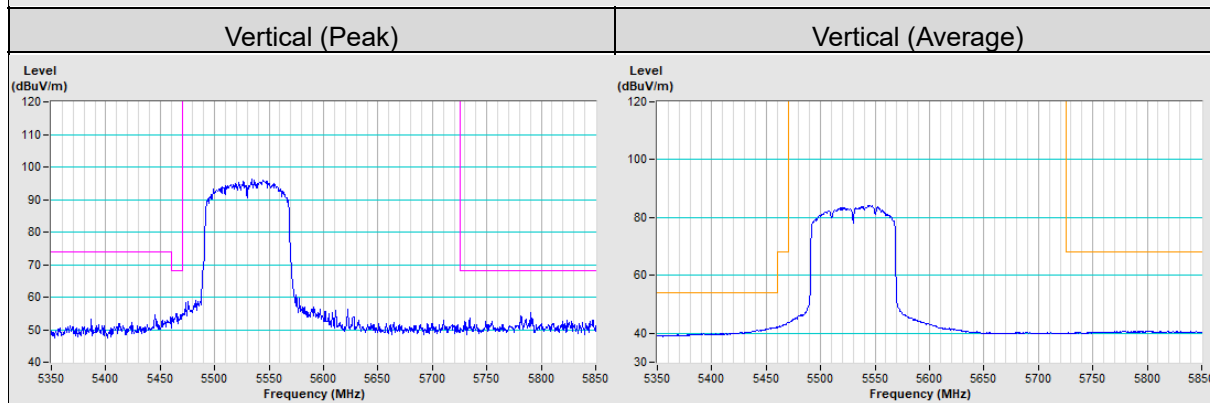
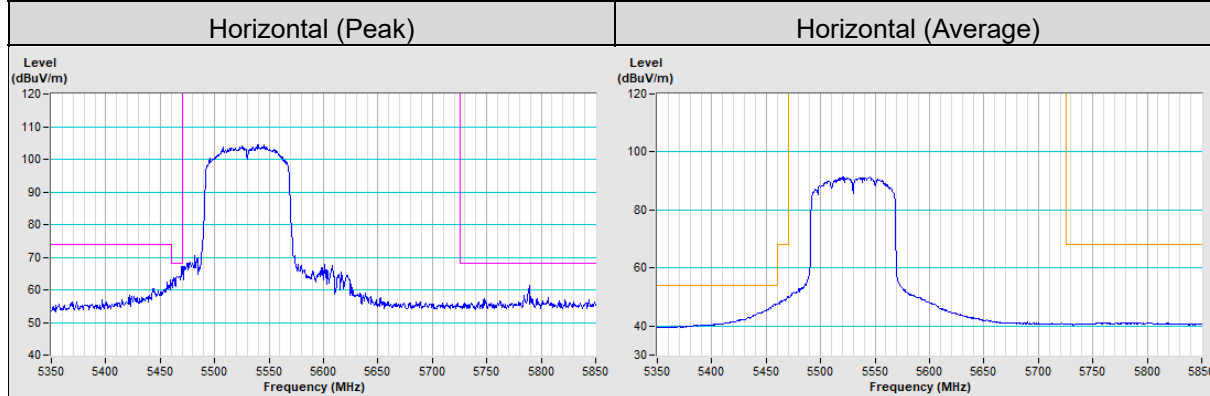

802.11ac (VHT80) Channel 122

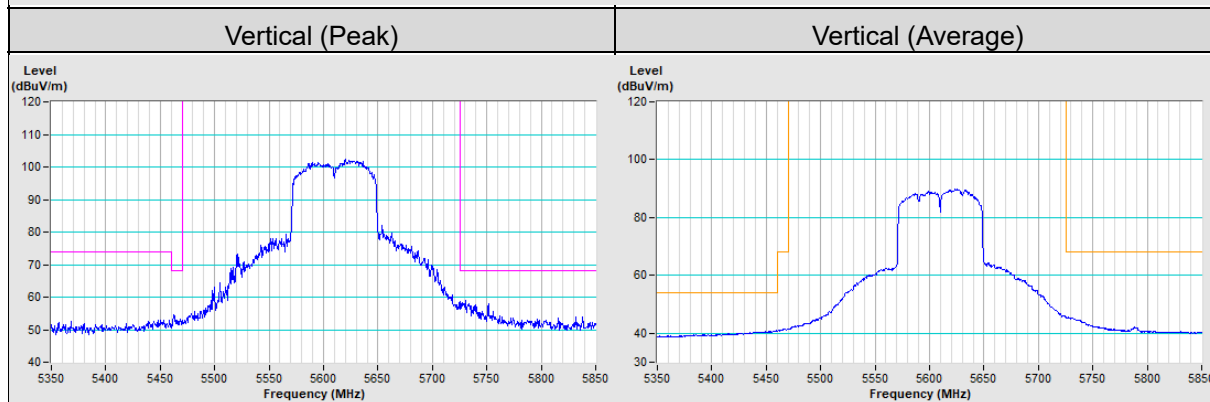
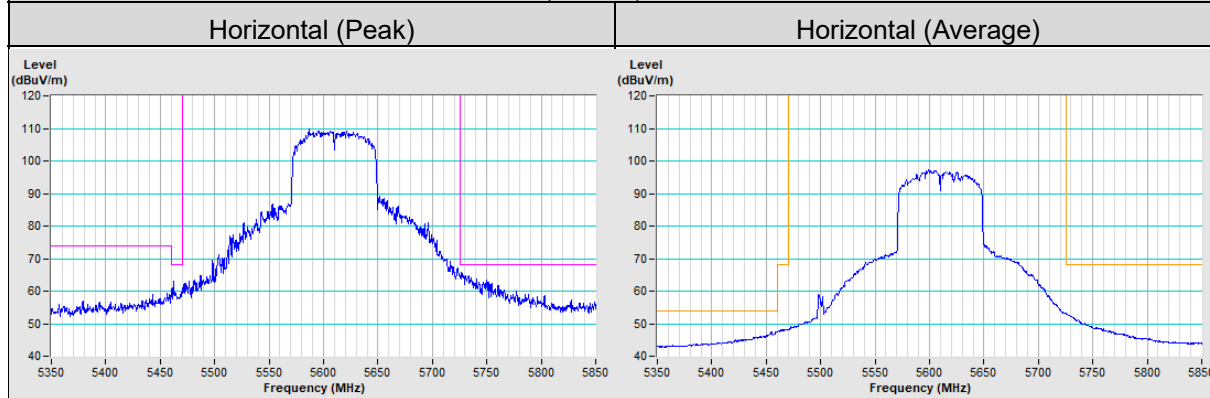

802.11ac (VHT80) Channel 138

Horizontal (Peak)

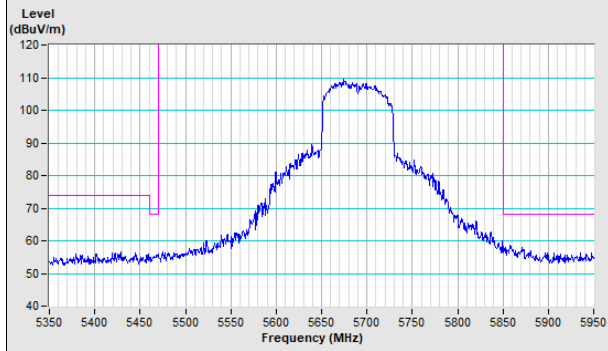

Vertical (Peak)

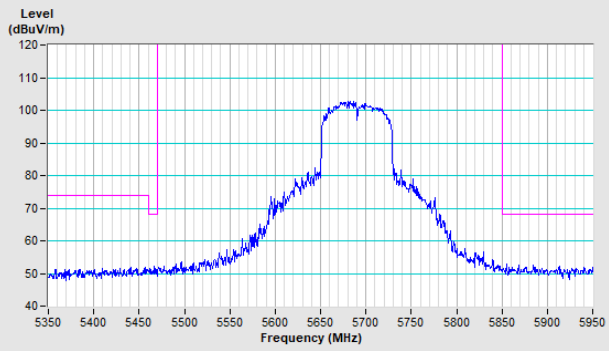

Appendix – Information of the Testing Laboratories

We, Bureau Veritas Consumer Products Services (H.K.) Ltd., Taoyuan Branch, were founded in 1988 to provide our best service in EMC, Radio, Telecom and Safety consultation. Our laboratories are FCC recognized accredited test firms and accredited and approved according to ISO/IEC 17025.

If you have any comments, please feel free to contact us at the following:

Lin Kou EMC/RF Lab

Tel: 886-2-26052180

Fax: 886-2-26051924

Hsin Chu EMC/RF/Telecom Lab

Tel: 886-3-6668565

Fax: 886-3-6668323

Hwa Ya EMC/RF/Safety Lab

Tel: 886-3-3183232

Fax: 886-3-3270892

Email: service.adt@tw.bureauveritas.com

Web Site: www.bureauveritas-adt.com

The address and road map of all our labs can be found in our web site also.

--- END ---