



# SPORTON International Inc.

No. 52, Hwa Ya 1st Rd., Kwei-Shan Hsiang, TaoYuan Hsien, Taiwan, R.O.C.  
Ph: 886-3-327-3456 / FAX: 886-3-327-0973 / www.sporton.com.tw

## FCC RADIO TEST REPORT

Applicant's company	Wistron NeWeb Corporation
Applicant Address	No.10-1,Li-hsin Road I,Hsinchu Science Park,Hsinchu 300,Taiwan, R.O.C.
FCC ID	NKR-RRPB83
Manufacturer's company	Wistron NeWeb Corporation
Manufacturer Address	No.10-1,Li-hsin Road I,Hsinchu Science Park,Hsinchu 300,Taiwan, R.O.C.

Product Name	Wireless VoIP Phone, Wireless VoIP Phone for Skype
Brand Name	Wistron NeWeb
Model Name	RRPB-83, RRPB-S2
Test Rule	47 CFR FCC Part 15 Subpart C § 15.247
Test Freq. Range	2400 ~ 2483.5MHz
Received Date	Oct. 23, 2006
Final Test Date	Oct. 31, 2006
Submission Type	Original Equipment
Multiple Listing	Please refer to section 3.7



### Statement

**Test result included is only for the 802.11b/g part of the product.**

The test result in this report refers exclusively to the presented test model / sample.

Without written approval of SPORTON International Inc., the test report shall not be reproduced except in full.

The measurements and test results shown in this test report were made in accordance with the procedures and found in compliance with the limit given in **ANSI C63.4-2003** and **47 CFR FCC Part 15 Subpart C**.

The test equipment used to perform the test is calibrated and traceable to NML/ROC.

## Table of Contents

<b>1. CERTIFICATE OF COMPLIANCE .....</b>	<b>1</b>
<b>2. SUMMARY OF THE TEST RESULT .....</b>	<b>2</b>
<b>3. GENERAL INFORMATION .....</b>	<b>3</b>
3.1. Product Details.....	3
3.2. Accessories.....	3
3.3. Table for Filed Antenna.....	3
3.4. Table for Carrier Frequencies .....	4
3.5. Table for Test Modes .....	4
3.6. Table for Testing Locations.....	5
3.7. Table for Multiple Listing.....	5
3.8. Table for Supporting Units .....	5
3.9. Table for Parameters of Test Software Setting .....	6
3.10. Test Configurations .....	7
<b>4. TEST RESULT .....</b>	<b>11</b>
4.1. AC Power Line Conducted Emissions Measurement.....	11
4.2. Maximum Peak Output Power Measurement .....	24
4.3. Power Spectral Density Measurement .....	26
4.4. 6dB Spectrum Bandwidth Measurement .....	31
4.5. Radiated Emissions Measurement .....	36
4.6. Band Edge Emissions Measurement .....	62
4.7. Antenna Requirements .....	69
<b>5. LIST OF MEASURING EQUIPMENTS .....</b>	<b>70</b>
<b>6. TEST LOCATION.....</b>	<b>72</b>
<b>APPENDIX A. PHOTOGRAPHS OF EUT.....</b>	<b>A1 ~ A28</b>
<b>APPENDIX B. TEST PHOTOS.....</b>	<b>B1 ~ B14</b>



## 1. CERTIFICATE OF COMPLIANCE

Product Name : Wireless VoIP Phone, Wireless VoIP Phone for Skype  
Brand Name : Wistron NeWeb  
Model Name : RRPB-83, RRPB-S2  
Applicant : Wistron NeWeb Corporation  
Test Rule Part(s) : 47 CFR FCC Part 15 Subpart C § 15.247

Sporton International as requested by the applicant to evaluate the EMC performance of the product sample received on Oct. 23, 2006 would like to declare that the tested sample has been evaluated and found to be in compliance with the tested rule parts. The data recorded as well as the test configuration specified is true and accurate for showing the sample's EMC nature.

Sharon Jiang 21.11.06

Prepared By:

Sharon Jiang / Specialist

Steven Lu 21.11.06

Tested By:

Steven Lu / Engineer

Wayne Hsu 21.11.06

Reviewed By:

Wayne Hsu

## 2. SUMMARY OF THE TEST RESULT

Applied Standard: 47 CFR FCC Part 15 Subpart C				
Part	Rule Section	Description of Test	Result	Under Limit
4.1	15.207	AC Power Line Conducted Emissions	Complies	11.63 dB
4.2	15.247(b)(3)	Maximum Peak Conducted Output Power	Complies	11.38 dB
4.3	15.247(e)	Power Spectral Density	Complies	17.14 dB
4.4	15.247(a)(2)	6dB Spectrum Bandwidth	Complies	-
4.5	15.247(d)	Radiated Emissions	Complies	1.07 dB
4.6	15.247(d)	Band Edge Emissions	Complies	9.60 dB
4.7	15.203	Antenna Requirements	Complies	-

Test Items	Uncertainty	Remark
AC Power Line Conducted Emissions	$\pm 2.26\text{dB}$	Confidence levels of 95%
Maximum Peak Conducted Output Power	$\pm 0.776\text{dB}$	Confidence levels of 95%
Power Spectral Density	$\pm 0.506\text{dB}$	Confidence levels of 95%
6dB Spectrum Bandwidth	$\pm 1.64 \times 10^{-6}$	Confidence levels of 95%
Radiated Emissions (9kHz~30MHz)	$\pm 0.754\text{dB}$	Confidence levels of 95%
Radiated Emissions (30MHz~1000MHz)	$\pm 1.89\text{dB}$	Confidence levels of 95%
Radiated / Band Edge Emissions (1GHz~18GHz)	$\pm 1.89\text{dB}$	Confidence levels of 95%
Radiated Emissions (18GHz~40GHz)	$\pm 1.86\text{dB}$	Confidence levels of 95%
Temperature	$\pm 0.7^{\circ}\text{C}$	Confidence levels of 95%
Humidity	$\pm 3.2\%$	Confidence levels of 95%
DC / AC Power Source	$\pm 0.04\%$	Confidence levels of 95%

### 3. GENERAL INFORMATION

#### 3.1. Product Details

Items	Description
Power Type	Power Adapter / Battery
Modulation	DSSS for IEEE 802.11b ; OFDM for IEEE 802.11g
Data Modulation	DSSS (BPSK / QPSK / CCK) ; OFDM (BPSK / QPSK / 16QAM / 64QAM)
Data Rate (Mbps)	DSSS (1/ 2/ 5.5/11) ; OFDM (6/9/12/18/24/36/48/54)
Frequency Range	2400 ~ 2483.5MHz
Channel Number	11
Channel Band Width (99%)	11b: 12.64 MHz ; 11g: 16.40 MHz
Conducted Output Power	11b: 16.71 dBm ; 11g: 18.62 dBm
Carrier Frequencies	Please refer to section 3.4
Antenna	Please refer to section 3.3

#### 3.2. Accessories

Power	Brand	Model	Rating
Adapter 1	DVE	DSA-10P-05 050050	Input: 100-240V, 50/60Hz, 0.3A Output: 5.0V, 1A
Adapter 2	DVE	DSA-5P-05 FUS 050100	Input: 100-240V, 50/60Hz, 0.2A Output: 5V, 1A
Accessories	Brand	Model	Rating
Desktop Charger	FORWARD	MS85NUNC001T	Input: 5VDC, 1A Output: 5VDC, 1A
Li-ion Battery	BYD	LP053450AR	3.7V, 900mAh

#### 3.3. Table for Filed Antenna

Ant.	Brand	Model Name	Antenna Type	Connector	Gain (dBi)
1	Wistron	RRPB-83	PIFA Antenna	NA	0.39
2	Wistron	Maglayer	Chip Antenna	NA	-0.45

Only the higher gain antenna "Ant.1" was tested and recorded in this report.

### 3.4. Table for Carrier Frequencies

Frequency Band	Channel No.	Frequency	Channel No.	Frequency
2400~2483.5MHz	1	2412 MHz	7	2442 MHz
	2	2417 MHz	8	2447 MHz
	3	2422 MHz	9	2452 MHz
	4	2427 MHz	10	2457 MHz
	5	2432 MHz	11	2462 MHz
	6	2437 MHz		

### 3.5. Table for Test Modes

Preliminary tests were performed in different data rate to find the worst radiated emission. The data rate shown in the table below is the worst-case rate with respect to the specific test item. Investigation has been done on all the possible configurations for searching the worst cases. The following table is a list of the test modes shown in this test report.

Test Items	Mode	Data Rate	Channel	Antenna
AC Power Line Conducted Emissions	Normal Link	11 Mbps	6	1
Maximum Peak Conducted Output Power Power Spectral Density 6dB Spectrum Bandwidth	11b/BPSK	1 Mbps	1/6/11	NA
	11g/BPSK	6 Mbps	1/6/11	NA
Radiated Emissions 9kHz~1GHz	11g/BPSK	6 Mbps	6	1
Radiated Emissions 1GHz~10 <sup>th</sup> Harmonic	11b/BPSK	1 Mbps	1/6/11	1
	11g/BPSK	6 Mbps	1/6/11	1
Band Edge Emissions	11b/BPSK	1 Mbps	1/11	1
	11g/BPSK	6 Mbps	1/11	1

Test Mode 1: EUT+ Adapter 1+Earphone

Test Mode 2: EUT+ Adapter 2+Earphone

Test Mode 3: EUT+ Adapter 1+Desktop Charger

Test Mode 4: EUT+ Adapter 2+Desktop Charger

Test Mode 5: EUT +USB+Earphone

Note:

Mode 1, Mode 2, Mode 5 for Radiated emission and Band-edge tests were performed at its 3-axis and the worst-case was found at z-axis. All the results have been recorded in this report.

### 3.6. Table for Testing Locations

Test Site No.	Site Category	Location	FCC Reg. No.	IC File No.	VCCI Reg. No
03CH03-HY	SAC	Hwa Ya	101377	IC 4088	-
CO04-HY	Conduction	Hwa Ya	101377	IC 4088	-
TH01-HY	OVEN Room	Hwa Ya	-	-	-

Open Area Test Site (OATS); Semi Anechoic Chamber (SAC); Fully Anechoic Chamber (FAC).

Please refer section 6 for Test Site Address.

### 3.7. Table for Multiple Listing

The Product/model names in the following table are all refer to the identical product.

Product Name	Model Name	Case Color
Wireless VoIP Phone	RRPB-83	White
Wireless VoIP Phone for Skype	RRPB-S2	Black

### 3.8. Table for Supporting Units

Support Unit	Brand	Model	FCC ID
Notebook	DELL	D505	E2K24GBRL
Printer	EPSON	LQ-300	DoC
Modem	ACEEX	DM1414	IFAXDM1414
AP	PLANEX	GW-AP54SGX	0090CC0F670
Earphone	Hiawk	MSB301	DoC



### 3.9. Table for Parameters of Test Software Setting

During testing, Channel & Power Controlling Software provided by the customer was used to control the operating channel as well as the output power level. The RF output power selection is for the setting of RF output power expected by the customer and is going to be fixed on the firmware of the final end product.

#### Power Parameters of IEEE 802.11b/g

Test Software Version	i4.8 mode2		
Frequency	2412 MHz	2437 MHz	2462 MHz
IEEE 802.11b	16.5	16.5	16.5
IEEE 802.11g	14.5	14.5	14.5

An executive program, EMCTEST.EXE under WIN XP, which generates a complete line of continuously repeating " H " pattern was used as the test software.

The program was executed as follows :

- a. Turn on the power of all equipment.
- b. The NB sends " H " messages to the panel, and the panel displays " H " patterns on the screen.
- c. The NB sends " H " messages to the printer, then the printer prints them on the paper.
- d. The NB sends " H " messages to the modem.
- e. Repeat the steps from b to d.

At the same time, the following programs were executed:

Executed " i4.8 mode2 " to control the EUT continuously transmitter RF signal.

Executed "ping.exe" to link with the remote workstation to receive and transmit data by WLAN.

### 3.10. Test Configurations

#### 3.10.1. Radiation Emissions Test Configuration

9kHz~1GHz

Test Mode: Mode 1 / Mode 2

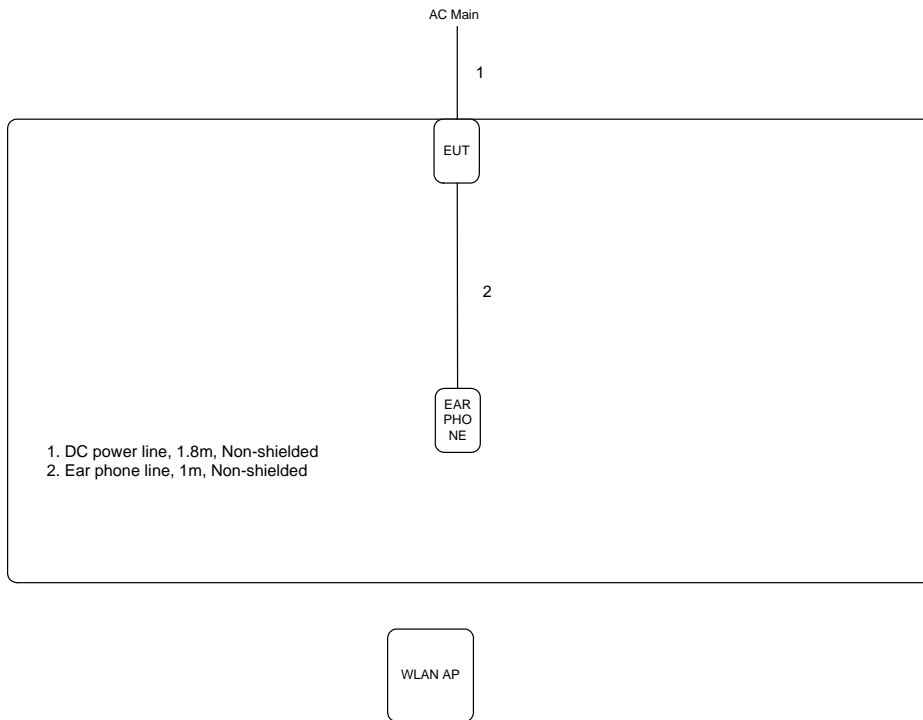

Test Mode: Mode 3 / Mode 4

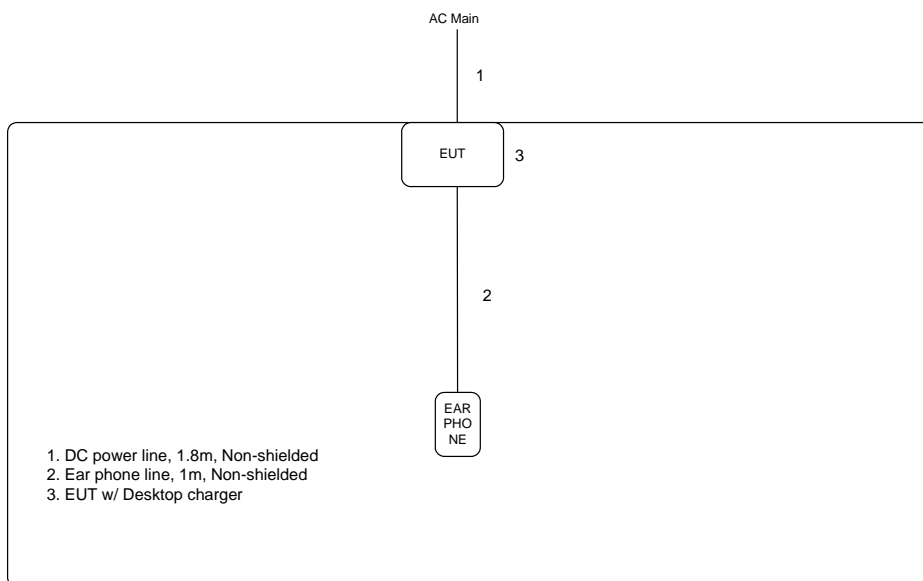

Test Mode: Mode 5

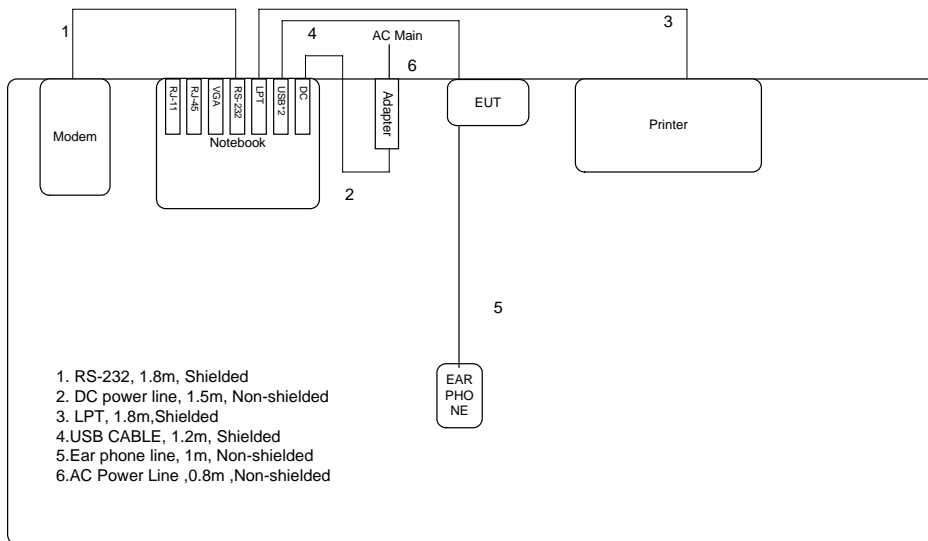

Above 1GHz

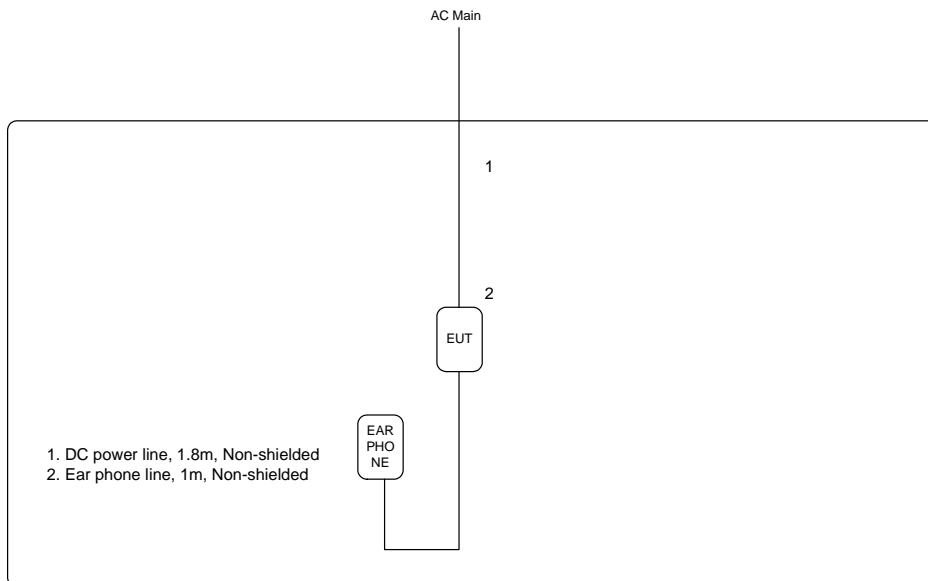

### 3.10.2.AC Power Line Conduction Emissions Test Configuration

Test Mode: Mode 1 / Mode 2

AC Main



Test Mode: Mode 3 / Mode 4

AC Main



Test Mode: Mode 5

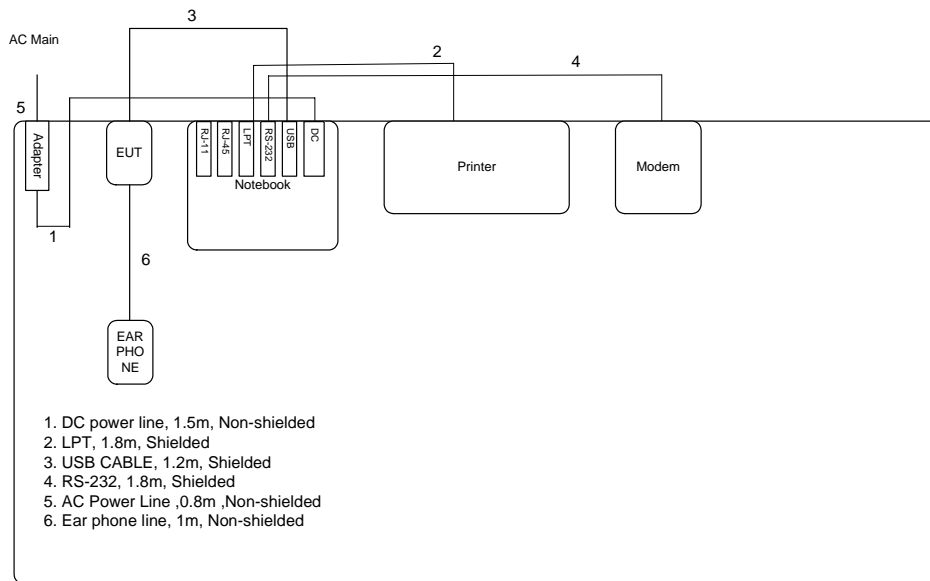

## 4. TEST RESULT

### 4.1. AC Power Line Conducted Emissions Measurement

#### 4.1.1. Limit

For this product which is designed to be connected to the AC power line, the radio frequency voltage that is conducted back onto the AC power line on any frequency or frequencies within the band 150 kHz to 30 MHz shall not exceed below limits table.

Frequency (MHz)	QP Limit (dBuV)	AV Limit (dBuV)
0.15~0.5	66~56	56~46
0.5~5	56	46
5~30	60	50

#### 4.1.2. Measuring Instruments and Setting

Please refer to section 5 of equipments list in this report. The following table is the setting of the receiver.

Receiver Parameters	Setting
Attenuation	10 dB
Start Frequency	0.15 MHz
Stop Frequency	30 MHz
IF Bandwidth	9 KHz

#### 4.1.3. Test Procedures

1. Configure the EUT according to ANSI C63.4. The EUT or host of EUT has to be placed 0.4 meter far from the conducting wall of the shielding room and at least 80 centimeters from any other grounded conducting surface.
2. Connect EUT or host of EUT to the power mains through a line impedance stabilization network (LISN).
3. All the support units are connected to the other LISNs. The LISN should provide 50uH/50ohms coupling impedance.
4. The frequency range from 150 KHz to 30 MHz was searched.
5. Set the test-receiver system to Peak Detect Function and Specified Bandwidth with Maximum Hold Mode.
6. The measurement has to be done between each power line and ground at the power terminal.

#### 4.1.4. Test Setup Layout

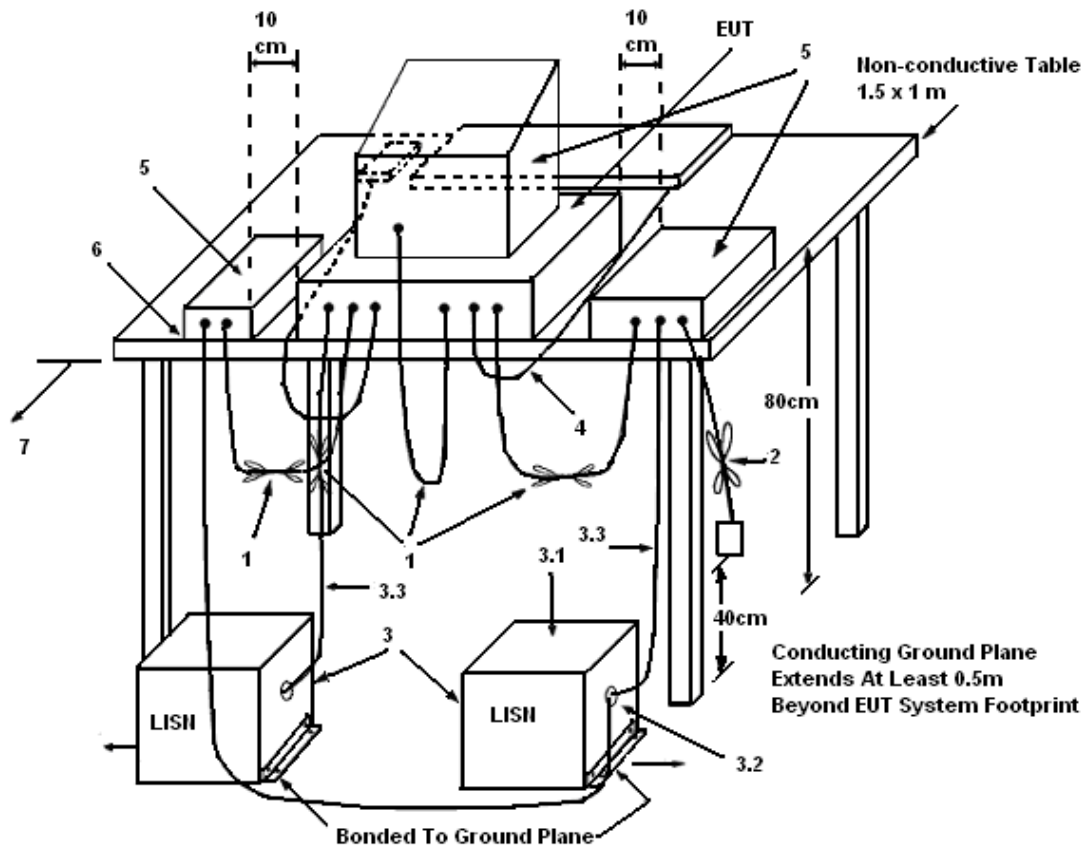

#### LEGEND:

- (1) Interconnecting cables that hang closer than 40 cm to the ground plane shall be folded back and forth in the center forming a bundle 30 to 40 cm long.
- (2) I/O cables that are not connected to a peripheral shall be bundled in the center. The end of the cable may be terminated, if required, using the correct terminating impedance. The overall length shall not exceed 1 m.
- (3) EUT connected to one LISN. Unused LISN measuring port connectors shall be terminated in  $50 \Omega$ . LISN can be placed on top of, or immediately beneath, reference ground plane.
  - (3.1) All other equipment powered from additional LISN(s).
  - (3.2) Multiple outlet strip can be used for multiple power cords of non-EUT equipment.
  - (3.3) LISN at least 80 cm from nearest part of EUT chassis.
- (4) Cables of hand-operated devices, such as keyboards, mice, etc., shall be placed as for normal use.
- (5) Non-EUT components of EUT system being tested.
- (6) Rear of EUT, including peripherals, shall all be aligned and flush with rear of tabletop.
- (7) Rear of tabletop shall be 40 cm removed from a vertical conducting plane that is bonded to the ground plane.

#### 4.1.5. Test Deviation

There is no deviation with the original standard.

#### 4.1.6. EUT Operation during Test

The EUT was placed on the test table and programmed in normal function.



4.1.7. Results of AC Power Line Conducted Emissions Measurement

Temperature	23°C	Humidity	63%
Test Engineer	Leo Hung	Phase	Line
Configuration	Normal Link / Mode 1		

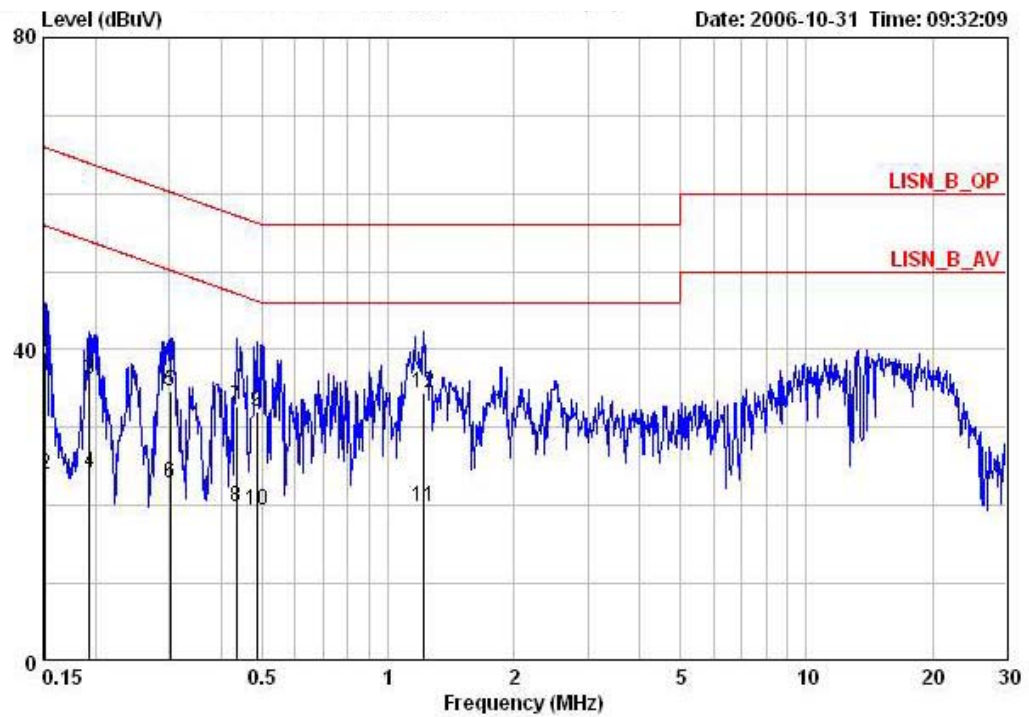

	Freq	Level	Over Limit	Limit Line	Read Level	LISN Factor	Cable Loss	Remark
	MHz	dBuV	dB	dBuV	dBuV	dB	dB	
1	0.15160	39.76	-26.16	65.91	39.36	0.20	0.20	QP
2	0.15160	23.90	-32.02	55.91	23.50	0.20	0.20	AVERAGE
3	0.19344	36.08	-27.81	63.89	35.77	0.11	0.20	QP
4	0.19344	24.14	-29.75	53.89	23.83	0.11	0.20	AVERAGE
5	0.30188	34.61	-25.58	60.19	34.37	0.04	0.20	QP
6	0.30188	22.79	-27.40	50.19	22.55	0.04	0.20	AVERAGE
7	0.43511	32.78	-24.37	57.15	32.58	0.00	0.20	QP
8	0.43511	19.87	-27.28	47.15	19.67	0.00	0.20	AVERAGE
9	0.48632	31.96	-24.27	56.23	31.86	0.00	0.10	QP
10	0.48632	19.37	-26.86	46.23	19.27	0.00	0.10	AVERAGE
11	1.216	19.91	-26.09	46.00	19.76	0.00	0.15	AVERAGE
12	1.216	34.41	-21.59	56.00	34.26	0.00	0.15	QP

Temperature	23°C	Humidity	63%
Test Engineer	Leo Hung	Phase	Neutral
Configuration	Normal Link / Mode 1		

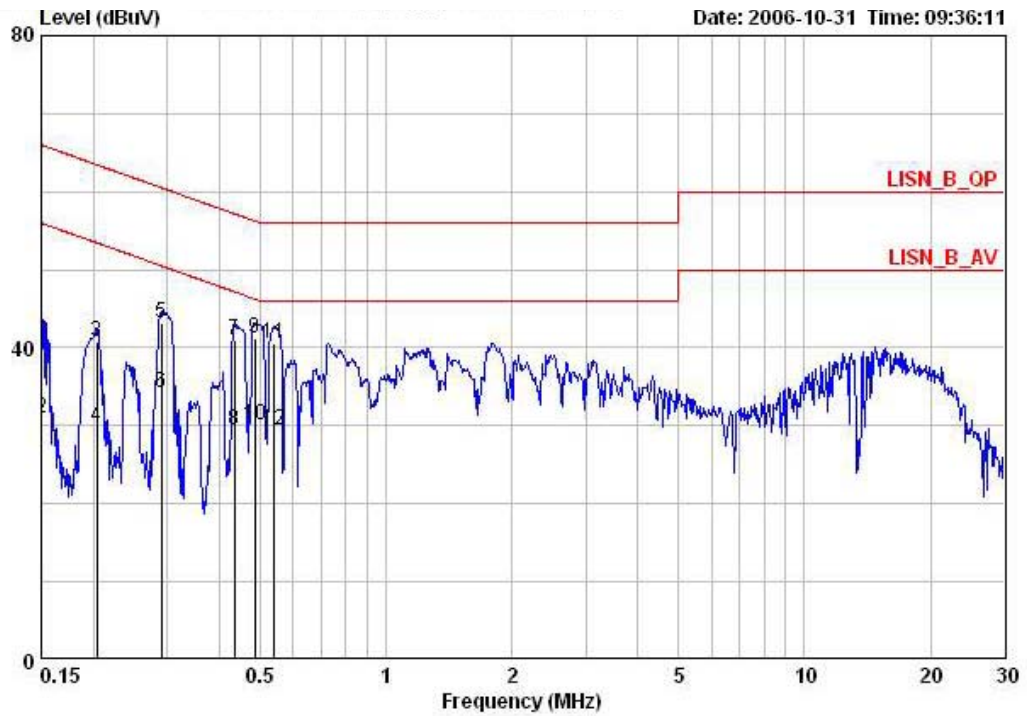

	Freq	Level	Over	Limit	Read	LISN	Cable	
	MHz	dBuV	Limit	Line	Level	Factor	Loss	Remark
			dB	dBuV	dBuV	dB	dB	
1	0.15000	39.02	-26.98	66.00	38.62	0.20	0.20	QP
2	0.15000	31.06	-24.94	56.00	30.66	0.20	0.20	AVERAGE
3	0.20396	40.72	-22.73	63.45	40.42	0.10	0.20	QP
4	0.20396	29.92	-23.53	53.45	29.62	0.10	0.20	AVERAGE
5	0.29088	43.06	-17.44	60.50	42.76	0.10	0.20	QP
6	0.29088	34.18	-16.32	50.50	33.88	0.10	0.20	AVERAGE
7	0.43511	41.06	-16.09	57.15	40.77	0.09	0.20	QP
8	0.43511	29.49	-17.66	47.15	29.20	0.09	0.20	AVERAGE
9	0.48632	41.12	-15.11	56.23	40.94	0.08	0.10	QP
10	0.48632	30.18	-16.05	46.23	30.00	0.08	0.10	AVERAGE
11	0.54068	40.57	-15.43	56.00	40.30	0.07	0.20	QP
12	0.54068	29.49	-16.51	46.00	29.22	0.07	0.20	AVERAGE

Note:

Level = Read Level + LISN Factor + Cable Loss.

Temperature	23°C	Humidity	63%
Test Engineer	Leo Hung	Phase	Line
Configuration	Normal Link / Mode 2		

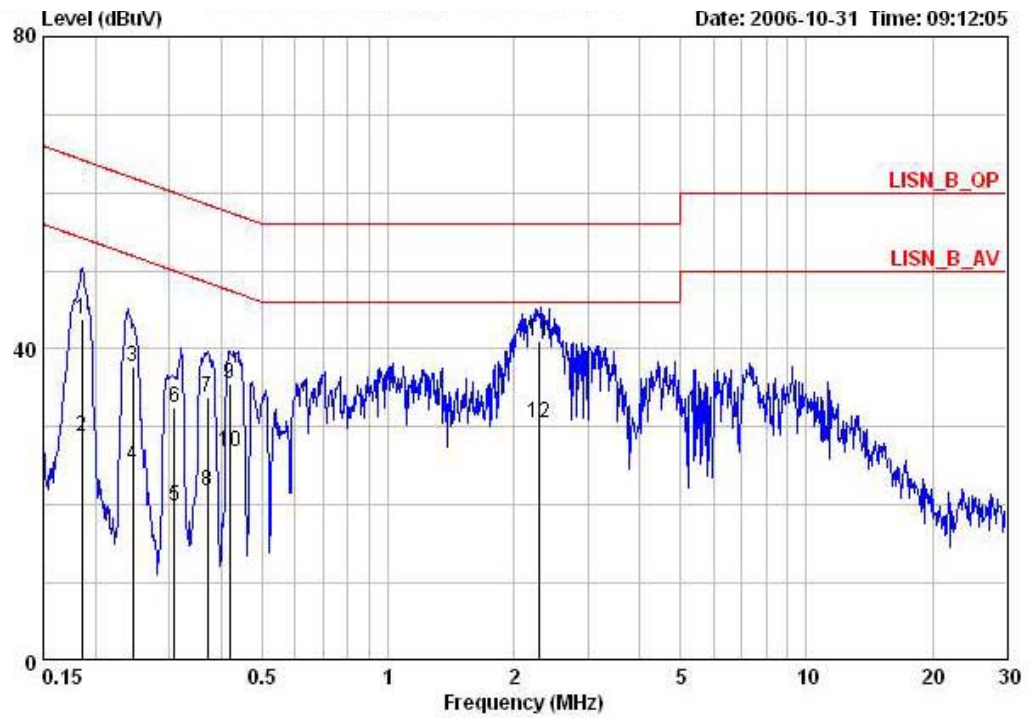

	Freq	Level	Over	Limit	Read	LISN	Cable	
	MHz	dBuV	Limit	Line	Level	Factor	Loss	Remark
			dB	dBuV	dBuV	dB	dB	
1	0.18541	43.79	-20.45	64.24	43.46	0.13	0.20	QP
2	0.18541	28.74	-25.50	54.24	28.41	0.13	0.20	AVERAGE
3	0.24610	37.65	-24.24	61.89	37.38	0.07	0.20	QP
4	0.24610	25.13	-26.76	51.89	24.86	0.07	0.20	AVERAGE
5	0.30912	19.79	-30.21	49.99	19.55	0.04	0.20	AVERAGE
6	0.30912	32.55	-27.45	59.99	32.31	0.04	0.20	QP
7	0.37117	33.80	-24.67	58.47	33.59	0.01	0.20	QP
8	0.37117	21.75	-26.72	48.47	21.54	0.01	0.20	AVERAGE
9	0.41927	35.54	-21.92	57.46	35.34	0.00	0.20	QP
10	0.41927	26.90	-20.56	47.46	26.70	0.00	0.20	AVERAGE
11	2.295	41.08	-14.92	56.00	40.88	0.00	0.20	QP
12	2.295	30.48	-15.52	46.00	30.28	0.00	0.20	AVERAGE

Temperature	23°C	Humidity	63%
Test Engineer	Leo Hung	Phase	Neutral
Configuration	Normal Link / Mode 2		

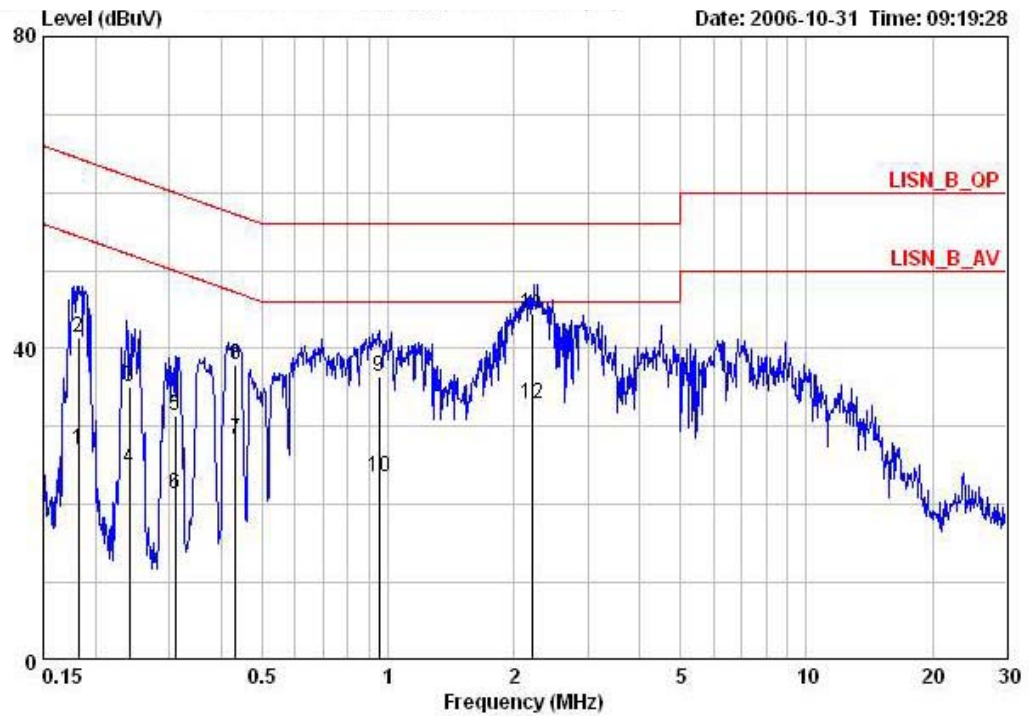

	Freq	Level	Over	Limit	Read	LISN	Cable	Remark
	MHz	dBuV	Limit	Line	Level	Factor	Loss	
			dB	dBuV	dBuV	dB	dB	
1	0.18249	27.12	-27.25	54.37	26.79	0.13	0.20	AVERAGE
2	0.18249	41.31	-23.06	64.37	40.98	0.13	0.20	QP
3	0.24109	35.16	-26.90	62.06	34.86	0.10	0.20	QP
4	0.24109	24.63	-27.43	52.06	24.33	0.10	0.20	AVERAGE
5	0.30998	31.32	-28.65	59.97	31.02	0.10	0.20	QP
6	0.30998	21.27	-28.70	49.97	20.97	0.10	0.20	AVERAGE
7	0.43210	28.36	-18.85	47.21	28.07	0.09	0.20	AVERAGE
8	0.43210	37.93	-19.28	57.21	37.64	0.09	0.20	QP
9	0.95313	36.47	-19.53	56.00	36.26	0.01	0.20	QP
10	0.95313	23.63	-22.37	46.00	23.42	0.01	0.20	AVERAGE
11	2.219	44.37	-11.63	56.00	44.17	0.00	0.20	QP
12	2.219	32.92	-13.08	46.00	32.72	0.00	0.20	AVERAGE

Note:

Level = Read Level + LISN Factor + Cable Loss.

Temperature	23°C	Humidity	63%
Test Engineer	Leo Hung	Phase	Line
Configuration	Normal Link / Mode 3		

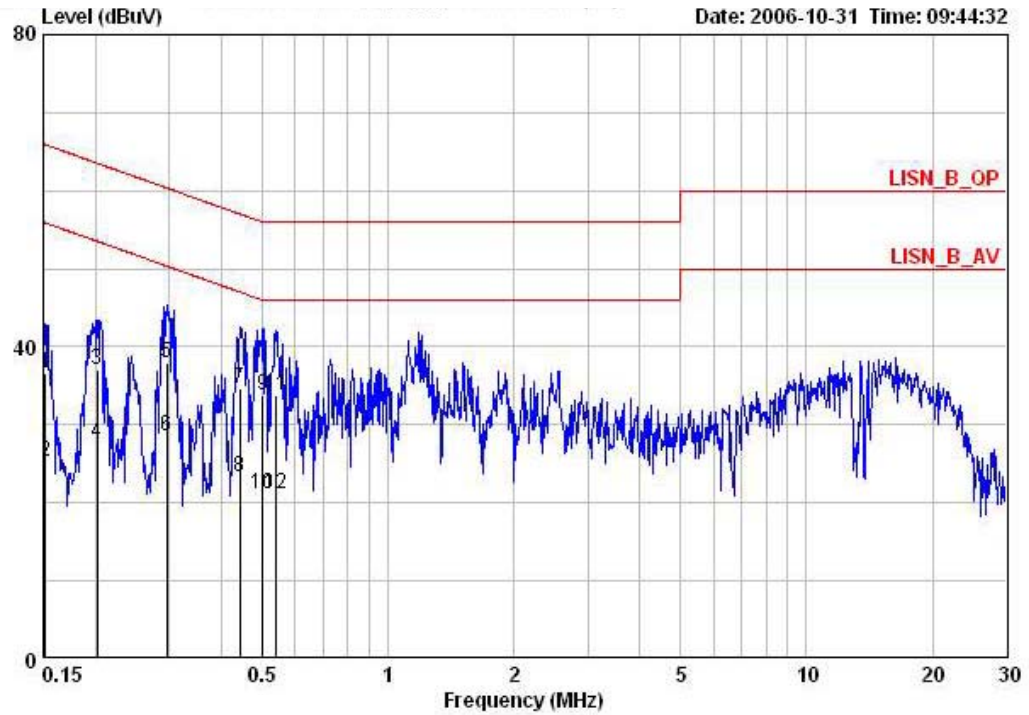

	Freq	Level	Over Limit	Limit Line	Read Level	LISN Factor	Cable Loss	Remark
	MHz	dBuV	dB	dBuV	dBuV	dB	dB	
1	0.15160	36.68	-29.24	65.91	36.28	0.20	0.20	QP
2	0.15160	25.23	-30.69	55.91	24.83	0.20	0.20	AVERAGE
3	0.20181	37.16	-26.38	63.54	36.86	0.10	0.20	QP
4	0.20181	27.59	-25.95	53.54	27.29	0.10	0.20	AVERAGE
5	0.29555	37.98	-22.38	60.37	37.74	0.04	0.20	QP
6	0.29555	28.62	-21.74	50.37	28.38	0.04	0.20	AVERAGE
7	0.44208	34.69	-22.33	57.02	34.49	0.00	0.20	QP
8	0.44208	23.32	-23.70	47.02	23.12	0.00	0.20	AVERAGE
9	0.50203	33.77	-22.23	56.00	33.57	0.00	0.20	QP
10	0.50203	21.20	-24.80	46.00	21.00	0.00	0.20	AVERAGE
11	0.54068	33.87	-22.13	56.00	33.67	0.00	0.20	QP
12	0.54068	21.05	-24.95	46.00	20.85	0.00	0.20	AVERAGE

Temperature	23°C	Humidity	63%
Test Engineer	Leo Hung	Phase	Neutral
Configuration	Normal Link / Mode 3		

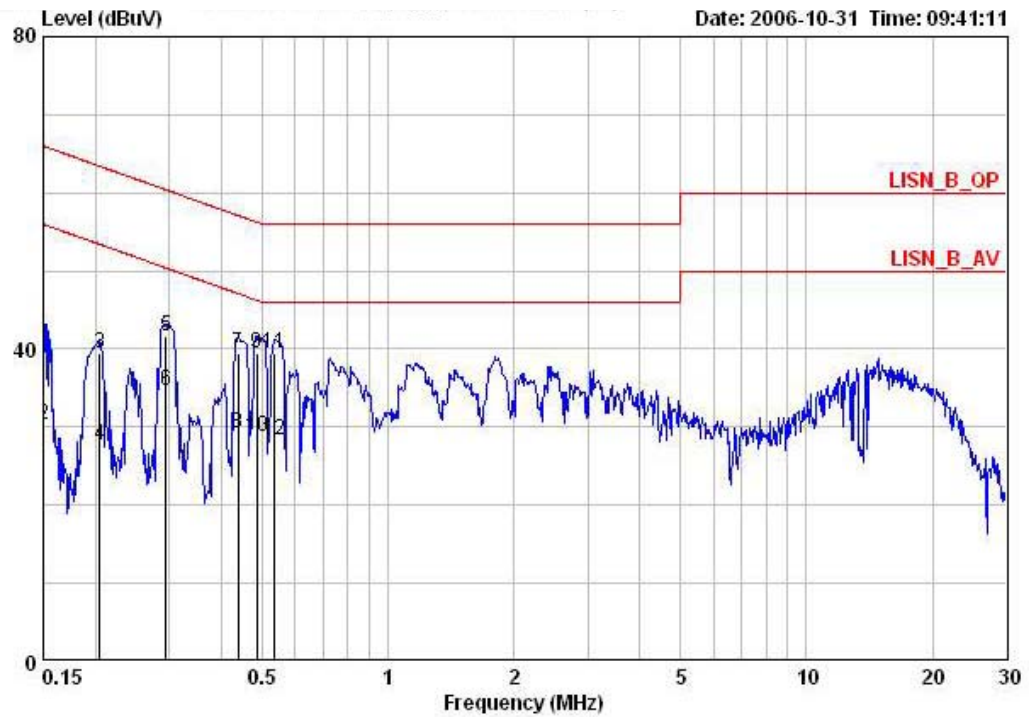

	Freq	Level	Over Limit	Limit Line	Read Level	LISN Factor	Cable Loss	Remark
	MHz	dBuV	dB	dBuV	dBuV	dB	dB	
1	0.15000	37.81	-28.19	66.00	37.41	0.20	0.20	QP
2	0.15000	30.28	-25.72	56.00	29.88	0.20	0.20	AVERAGE
3	0.20505	39.42	-23.98	63.40	39.12	0.10	0.20	QP
4	0.20505	27.70	-25.70	53.40	27.40	0.10	0.20	AVERAGE
5	0.29398	41.66	-18.75	60.41	41.36	0.10	0.20	QP
6	0.29398	34.62	-15.79	50.41	34.32	0.10	0.20	AVERAGE
7	0.43742	39.48	-17.63	57.11	39.19	0.09	0.20	QP
8	0.43742	29.17	-17.94	47.11	28.88	0.09	0.20	AVERAGE
9	0.48632	39.56	-16.67	56.23	39.38	0.08	0.10	QP
10	0.48632	28.67	-17.56	46.23	28.49	0.08	0.10	AVERAGE
11	0.53498	39.46	-16.54	56.00	39.19	0.07	0.20	QP
12	0.53498	28.32	-17.68	46.00	28.05	0.07	0.20	AVERAGE

Note:

Level = Read Level + LISN Factor + Cable Loss.

Temperature	23°C	Humidity	63%
Test Engineer	Leo Hung	Phase	Line
Configuration	Normal Link / Mode 4		

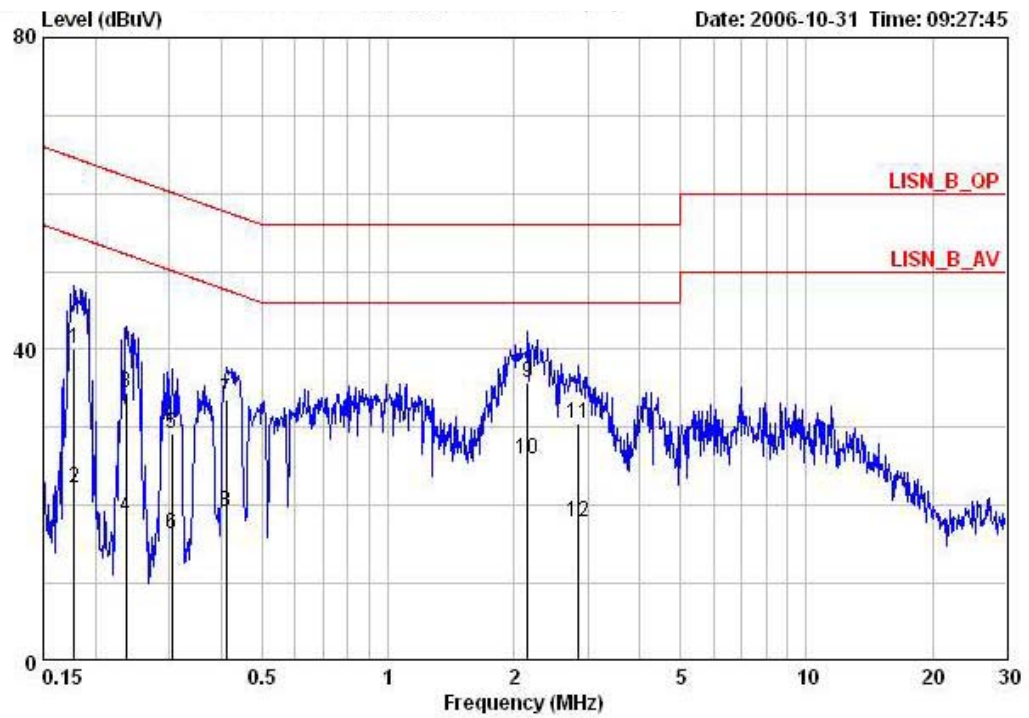

	Freq	Level	Over	Limit	Read	LISN	Cable	Remark
	MHz	dBuV	Limit	Line	Level	Factor	Loss	
			dB	dBuV	dBuV	dB	dB	
1	0.17772	40.07	-24.52	64.59	39.73	0.14	0.20	QP
2	0.17772	22.31	-32.28	54.59	21.97	0.14	0.20	AVERAGE
3	0.23658	34.53	-27.69	62.22	34.25	0.08	0.20	QP
4	0.23658	18.63	-33.59	52.22	18.35	0.08	0.20	AVERAGE
5	0.30509	29.29	-30.81	60.10	29.05	0.04	0.20	QP
6	0.30509	16.29	-33.81	50.10	16.05	0.04	0.20	AVERAGE
7	0.41048	33.53	-24.11	57.64	33.33	0.00	0.20	QP
8	0.41048	19.26	-28.38	47.64	19.06	0.00	0.20	AVERAGE
9	2.155	35.68	-20.32	56.00	35.48	0.00	0.20	QP
10	2.155	26.02	-19.98	46.00	25.82	0.00	0.20	AVERAGE
11	2.854	30.55	-25.45	56.00	30.35	0.00	0.20	QP
12	2.854	17.98	-28.02	46.00	17.78	0.00	0.20	AVERAGE

Temperature	23°C	Humidity	63%
Test Engineer	Leo Hung	Phase	Neutral
Configuration	Normal Link / Mode 4		

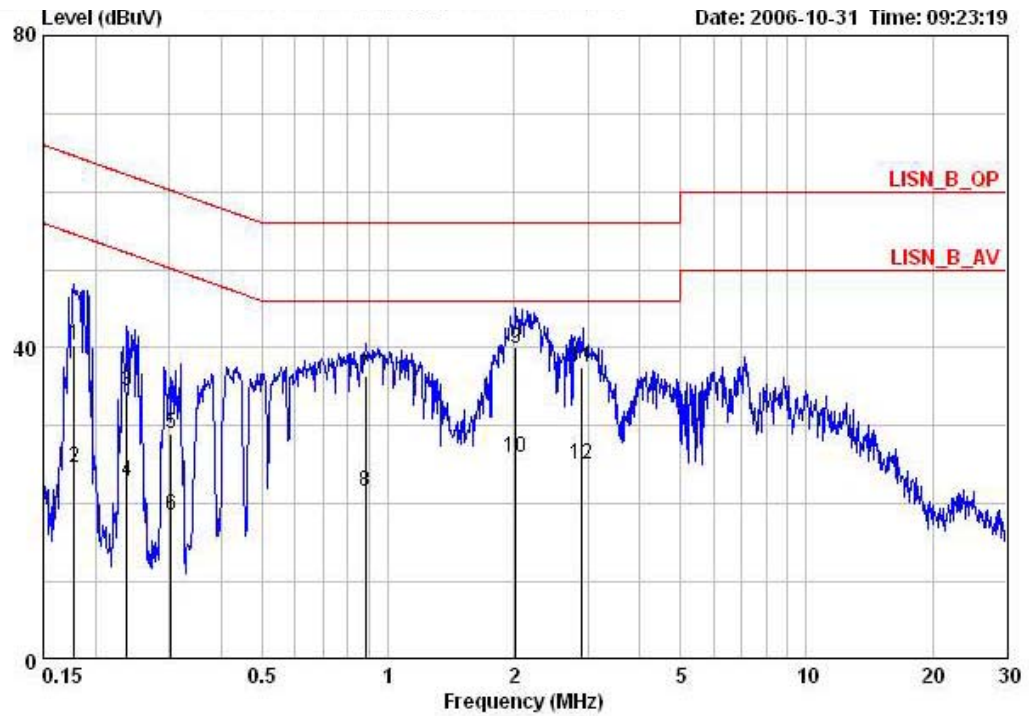

	Freq	Level	Over Limit	Limit Line	Read Level	LISN Factor	Cable Loss	Remark
	MHz	dBuV	dB	dBuV	dBuV	dB	dB	
1	0.17772	40.29	-24.30	64.59	39.95	0.14	0.20	QP
2	0.17772	24.54	-30.05	54.59	24.20	0.14	0.20	AVERAGE
3	0.23784	34.41	-27.76	62.17	34.11	0.10	0.20	QP
4	0.23784	22.79	-29.38	52.17	22.49	0.10	0.20	AVERAGE
5	0.30305	29.08	-31.08	60.16	28.78	0.10	0.20	QP
6	0.30305	18.48	-31.68	50.16	18.18	0.10	0.20	AVERAGE
7	0.88499	36.37	-19.63	56.00	36.16	0.01	0.20	QP
8	0.88499	21.52	-24.48	46.00	21.31	0.01	0.20	AVERAGE
9	2.023	40.00	-16.00	56.00	39.80	0.00	0.20	QP
10	2.023	25.96	-20.04	46.00	25.76	0.00	0.20	AVERAGE
11	2.906	37.41	-18.59	56.00	37.21	0.00	0.20	QP
12	2.906	25.13	-20.87	46.00	24.93	0.00	0.20	AVERAGE

Note:

Level = Read Level + LISN Factor + Cable Loss.



Temperature	23°C	Humidity	63%
Test Engineer	Leo Hung	Phase	Line
Configuration	Normal Link / Mode 5		

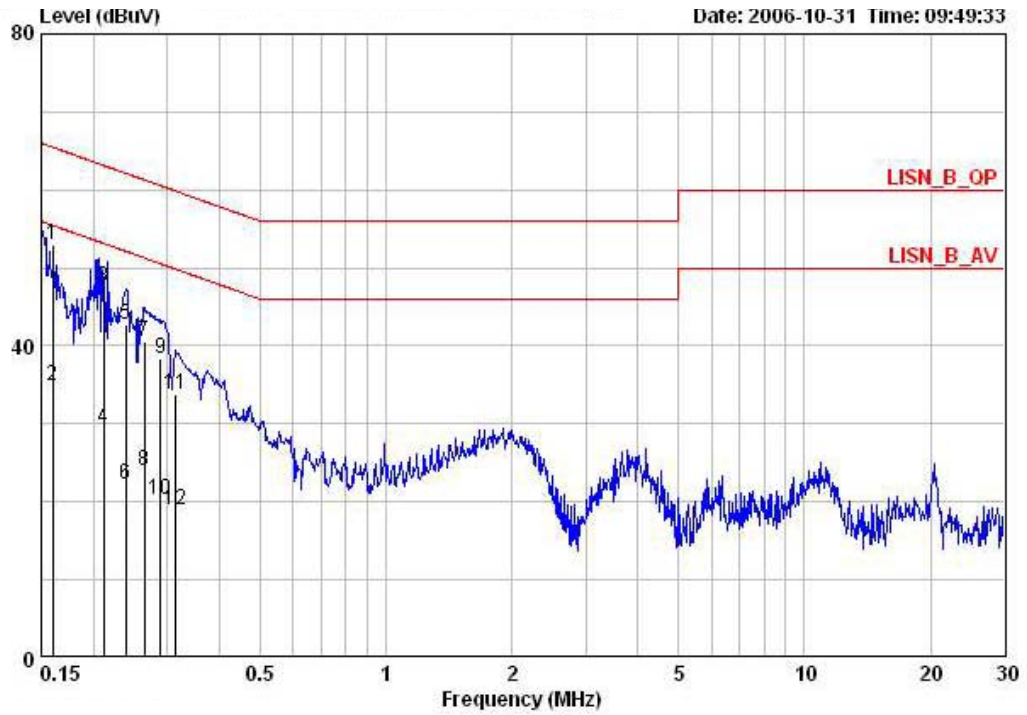

	Freq	Level	Over	Limit	Read	LISN	Cable	
	MHz	dBuV	Limit	Line	Level	Factor	Loss	Remark
			dB	dBuV	dBuV	dB	dB	
1	0.16005	53.07	-12.39	65.46	52.69	0.18	0.20	QP
2	0.16005	34.95	-20.51	55.46	34.57	0.18	0.20	AVERAGE
3	0.21139	47.61	-15.54	63.15	47.32	0.09	0.20	QP
4	0.21139	29.44	-23.71	53.15	29.15	0.09	0.20	AVERAGE
5	0.23910	42.65	-19.47	62.13	42.38	0.07	0.20	QP
6	0.23910	22.18	-29.94	52.13	21.91	0.07	0.20	AVERAGE
7	0.26442	40.60	-20.69	61.29	40.34	0.06	0.20	QP
8	0.26442	24.00	-27.29	51.29	23.74	0.06	0.20	AVERAGE
9	0.28935	38.31	-22.24	60.54	38.06	0.05	0.20	QP
10	0.28935	20.26	-30.29	50.54	20.01	0.05	0.20	AVERAGE
11	0.31328	33.84	-26.05	59.88	33.60	0.04	0.20	QP
12	0.31328	18.89	-31.00	49.88	18.65	0.04	0.20	AVERAGE

Temperature	23°C	Humidity	63%
Test Engineer	Leo Hung	Phase	Neutral
Configuration	Normal Link / Mode 5		

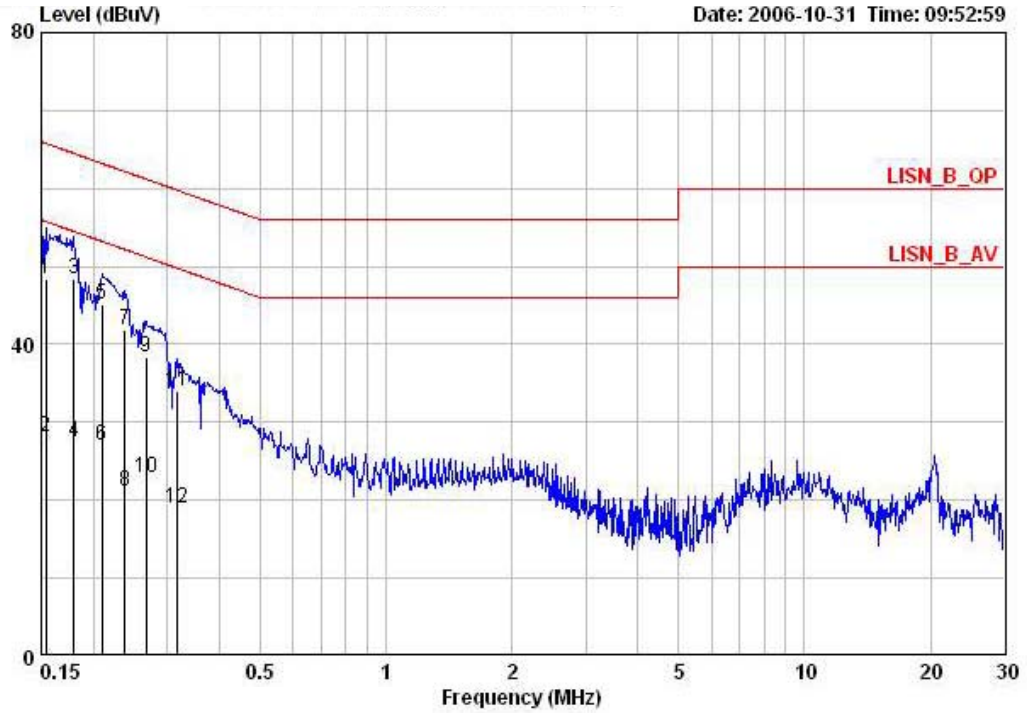

	Freq	Level	Over	Limit	Read	LISN	Cable	Remark
	MHz	dBuV	Limit	Line	Level	Factor	Loss	
			dB	dBuV	dBuV	dB	dB	
1	0.15403	48.48	-17.30	65.78	48.09	0.19	0.20	QP
2	0.15403	28.03	-27.75	55.78	27.64	0.19	0.20	AVERAGE
3	0.17961	48.35	-16.16	64.50	48.01	0.14	0.20	QP
4	0.17961	27.48	-27.03	54.50	27.14	0.14	0.20	AVERAGE
5	0.20944	45.23	-18.00	63.23	44.93	0.10	0.20	QP
6	0.20944	27.09	-26.14	53.23	26.79	0.10	0.20	AVERAGE
7	0.23784	41.78	-20.39	62.17	41.48	0.10	0.20	QP
8	0.23784	21.15	-31.02	52.17	20.85	0.10	0.20	AVERAGE
9	0.26724	38.31	-22.89	61.20	38.01	0.10	0.20	QP
10	0.26724	22.86	-28.34	51.20	22.56	0.10	0.20	AVERAGE
11	0.31662	34.06	-25.74	59.80	33.76	0.10	0.20	QP
12	0.31662	18.95	-30.85	49.80	18.65	0.10	0.20	AVERAGE

Note:

Level = Read Level + LISN Factor + Cable Loss.

## 4.2. Maximum Peak Output Power Measurement

### 4.2.1. Limit

For systems using digital modulation in the 2400-2483.5MHz, the limit for peak output power is 30dBm. The limited has to be reduced by the amount in dB that the gain of the antenna exceed 6dBi. In case of point-to-point operation, the limit has to be reduced by 1dB for every 3dB that the directional gain of the antenna exceeds 6dBi.

### 4.2.2. Measuring Instruments and Setting

Please refer to section 5 of equipments list in this report. The following table is the setting of the power meter.

Power Meter Parameter	Setting
Filter No.	Auto
Measurement time	0.135 s ~ 26 s
Used Peak Sensor	NRV-Z32 (model 04)

### 4.2.3. Test Procedures

1. The transmitter output (antenna port) was connected to the power meter.
2. Turn on the EUT and power meter and then record the peak power value.
3. Repeat above procedures on all channels needed to be tested.

### 4.2.4. Test Setup Layout

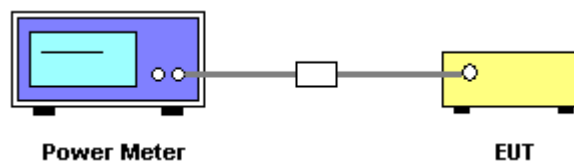

### 4.2.5. Test Deviation

There is no deviation with the original standard.

### 4.2.6. EUT Operation during Test

The EUT was programmed to be in continuously transmitting mode.

#### 4.2.7. Test Result of Maximum Peak Output Power

<b>Temperature</b>	23°C	<b>Humidity</b>	63%
<b>Test Engineer</b>	Leo Hung	<b>Configurations</b>	802.11b/g

##### Configuration IEEE 802.11b

Channel	Frequency	Conducted Power (dBm)	Max. Limit (dBm)	Result
1	2412 MHz	16.71	30.00	Complies
6	2437 MHz	16.53	30.00	Complies
11	2462 MHz	16.29	30.00	Complies

##### Configuration IEEE 802.11g

Channel	Frequency	Conducted Power (dBm)	Max. Limit (dBm)	Result
1	2412 MHz	18.62	30.00	Complies
6	2437 MHz	18.45	30.00	Complies
11	2462 MHz	18.26	30.00	Complies

### 4.3. Power Spectral Density Measurement

#### 4.3.1. Limit

For digitally modulated systems, the power spectral density conducted from the intentional radiator to the antenna shall not be greater than 8 dBm in any 3 kHz band during any time interval of continuous transmission.

#### 4.3.2. Measuring Instruments and Setting

Please refer to section 5 of equipments list in this report. The following table is the setting of the spectrum analyzer.

Spectrum Parameter	Setting
Attenuation	Auto
Span Frequency	1.5MHz
RB	3 kHz
VB	30 kHz
Detector	Peak
Trace	Max Hold
Sweep Time	500s

#### 4.3.3. Test Procedures

1. The transmitter output (antenna port) was connected to the spectrum analyser.
2. Set RBW of spectrum analyzer to 3kHz and VBW to 30kHz. Set Detector to Peak, Trace to Max Hold.
3. Mark the frequency with maximum peak power as the center of the display of the spectrum.
4. Set the span to 1.5MHz and the sweep time to 500s and record the maximum peak value.

#### 4.3.4. Test Setup Layout

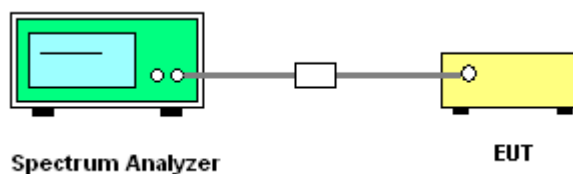

#### 4.3.5. Test Deviation

There is no deviation with the original standard.

#### 4.3.6. EUT Operation during Test

The EUT was programmed to be in continuously transmitting mode.

#### 4.3.7. Test Result of Power Spectral Density

<b>Temperature</b>	23°C	<b>Humidity</b>	63%
<b>Test Engineer</b>	Leo Hung	<b>Configurations</b>	802.11b/g

##### Configuration IEEE 802.11b

Channel	Frequency	Power Density (dBm)	Max. Limit (dBm)	Result
1	2412 MHz	-9.14	8.00	Complies
6	2437 MHz	-9.90	8.00	Complies
11	2462 MHz	-9.69	8.00	Complies

##### Configuration IEEE 802.11g

Channel	Frequency	Power Density (dBm)	Max. Limit (dBm)	Result
1	2412 MHz	-15.23	8.00	Complies
6	2437 MHz	-15.81	8.00	Complies
11	2462 MHz	-15.61	8.00	Complies

**Power Density Plot on Configuration IEEE 802.11b / 2412 MHz**

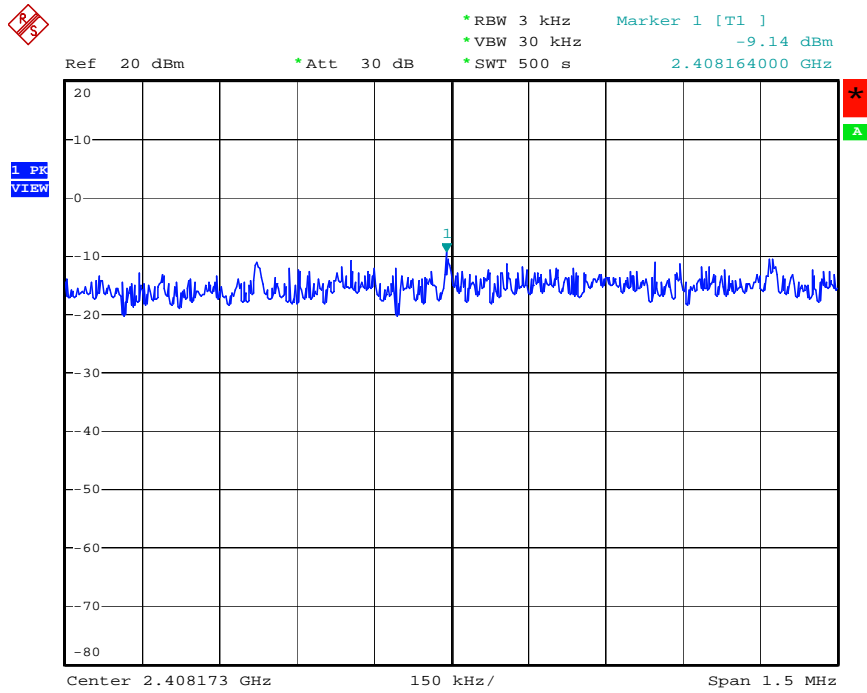

Date: 30.OCT.2006 10:15:09

**Power Density Plot on Configuration IEEE 802.11b / 2437 MHz**

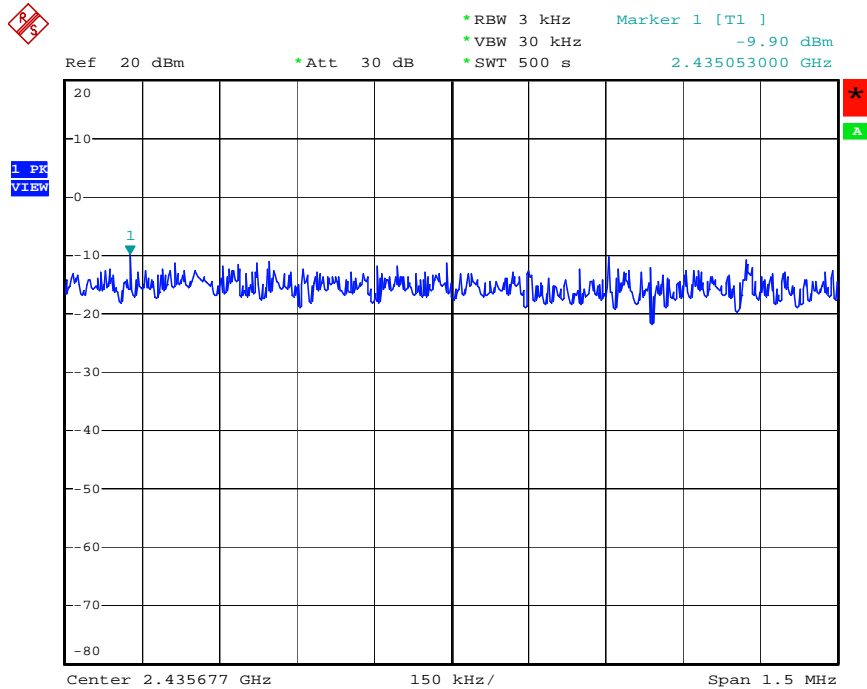

Date: 30.OCT.2006 10:16:14

**Power Density Plot on Configuration IEEE 802.11b / 2462 MHz**

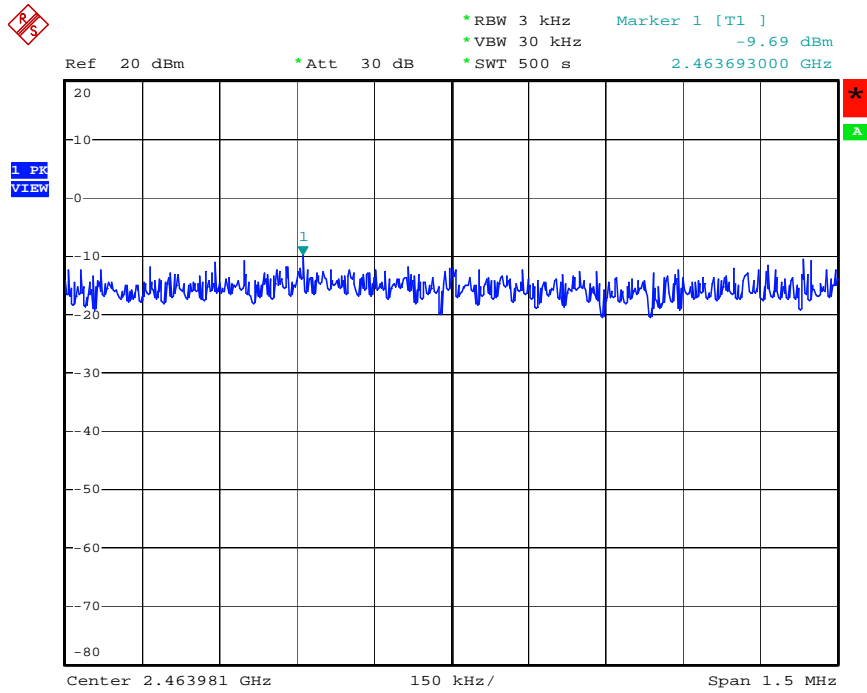

Date: 30.OCT.2006 10:17:03

**Power Density Plot on Configuration IEEE 802.11g / 2412 MHz**

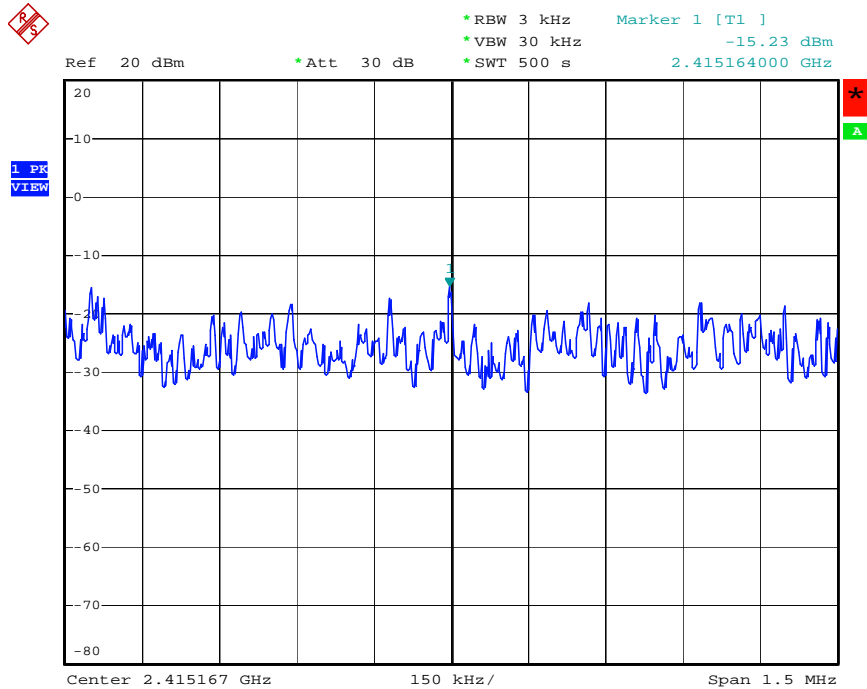

Date: 30.OCT.2006 10:50:16



**Power Density Plot on Configuration IEEE 802.11g / 2437 MHz**

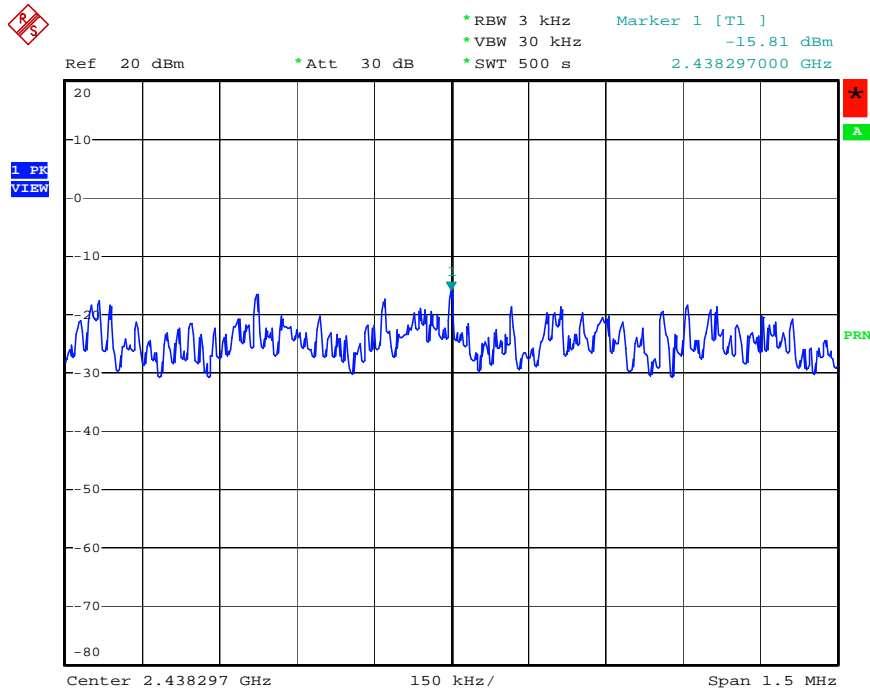

Date: 30.OCT.2006 10:52:40

**Power Density Plot on Configuration IEEE 802.11g / 2462 MHz**

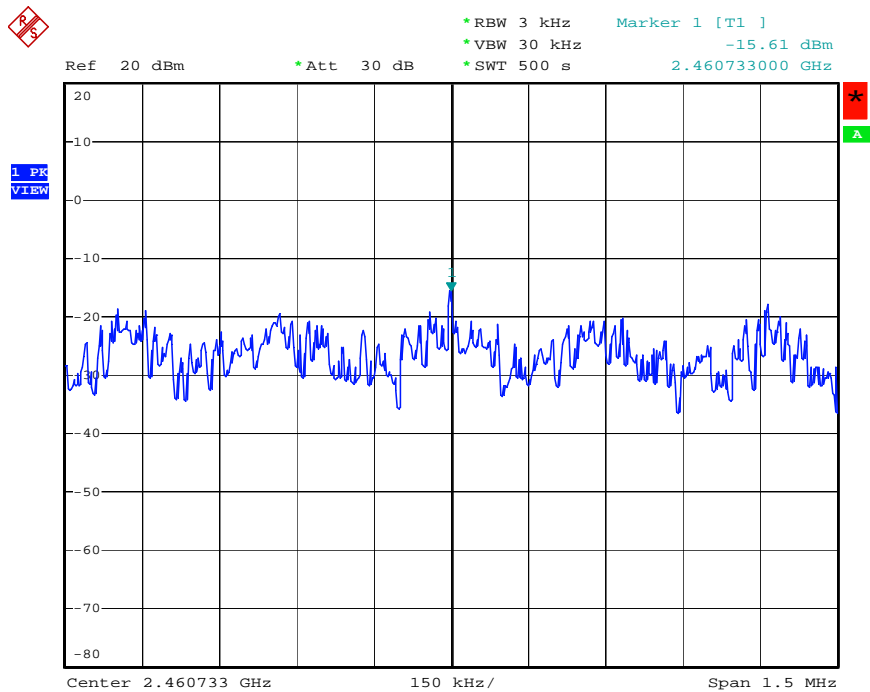

Date: 30.OCT.2006 10:53:31

#### 4.4. 6dB Spectrum Bandwidth Measurement

##### 4.4.1. Limit

For digital modulation systems, the minimum 6dB bandwidth shall be at least 500 kHz.

##### 4.4.2. Measuring Instruments and Setting

Please refer to section 5 of equipments list in this report. The following table is the setting of the spectrum analyzer.

Spectrum Parameters	Setting
Attenuation	Auto
Span Frequency	> 6dB Bandwidth
RB	100 kHz
VB	100 kHz
Detector	Peak
Trace	Max Hold
Sweep Time	Auto

##### 4.4.3. Test Procedures

1. The transmitter output (antenna port) was connected to the spectrum analyser in peak hold mode.
2. The resolution bandwidth of 100 kHz and the video bandwidth of 100 kHz were used.
3. Measured the spectrum width with power higher than 6dB below carrier.

##### 4.4.4. Test Setup Layout

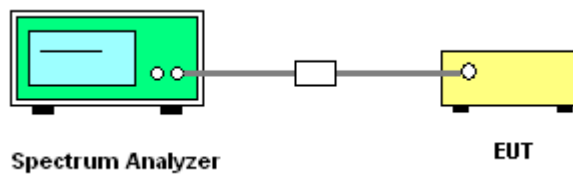

#### 4.4.5. Test Deviation

There is no deviation with the original standard.

#### 4.4.6. EUT Operation during Test

The EUT was programmed to be in continuously transmitting mode.

#### 4.4.7. Test Result of 6dB Spectrum Bandwidth

<b>Temperature</b>	23°C	<b>Humidity</b>	63%
<b>Test Engineer</b>	Leo Hung	<b>Configurations</b>	802.11b/g

##### Configuration IEEE 802.11b

Channel	Frequency	6dB Bandwidth (MHz)	99% Occupied Bandwidth (MHz)	Min. Limit (kHz)	Test Result
1	2412 MHz	10.08	12.60	500	Complies
6	2437 MHz	10.08	12.64	500	Complies
11	2462 MHz	10.08	12.60	500	Complies

##### Configuration IEEE 802.11g

Channel	Frequency	6dB Bandwidth (MHz)	99% Occupied Bandwidth (MHz)	Min. Limit (kHz)	Test Result
1	2412 MHz	16.36	16.40	500	Complies
6	2437 MHz	16.28	16.40	500	Complies
11	2462 MHz	16.36	16.40	500	Complies

### 6 dB Bandwidth Plot on Configuration IEEE 802.11b / 2412 MHz

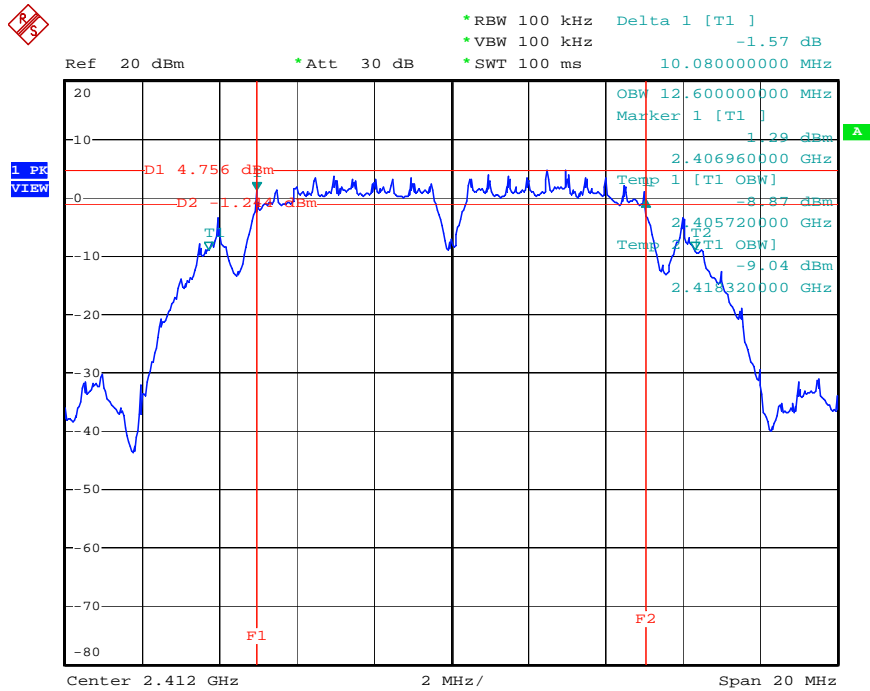

Date: 30.OCT.2006 10:14:43

### 6 dB Bandwidth Plot on Configuration IEEE 802.11b / 2437 MHz

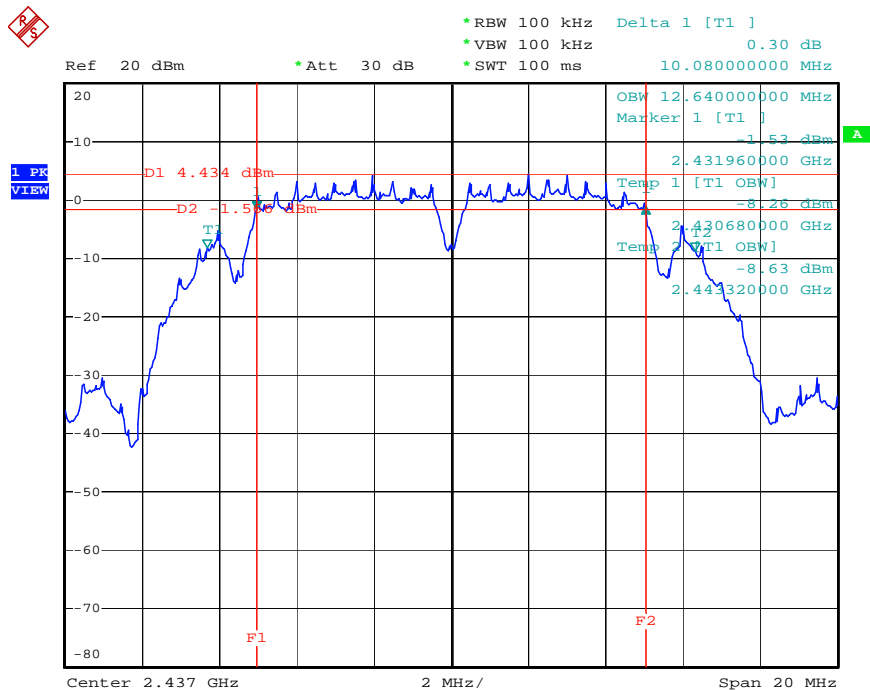

Date: 30.OCT.2006 10:15:57

### 6 dB Bandwidth Plot on Configuration IEEE 802.11b / 2462 MHz

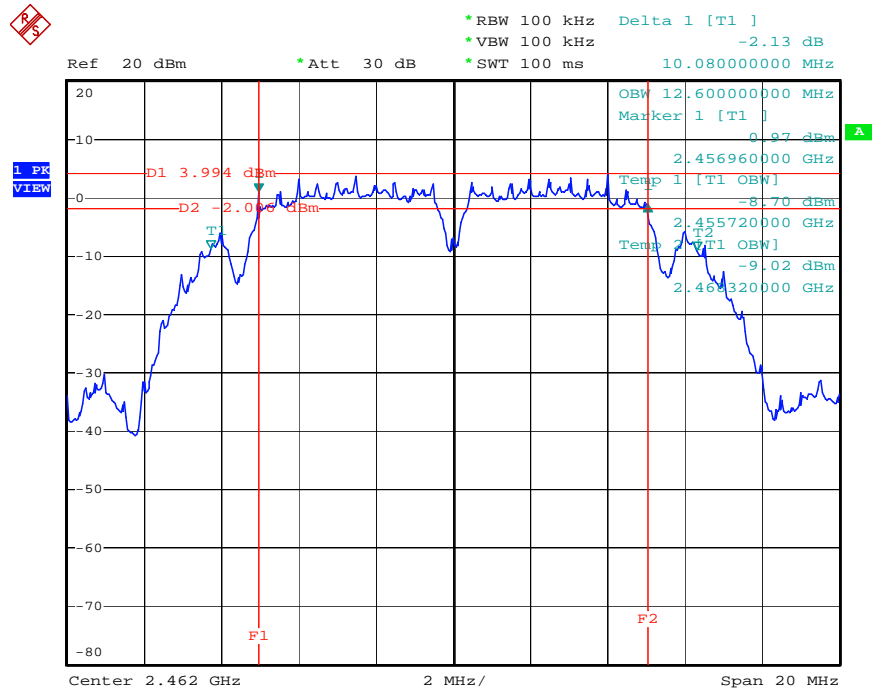

Date: 30.OCT.2006 10:16:47

### 6 dB Bandwidth Plot on Configuration IEEE 802.11g / 2412 MHz

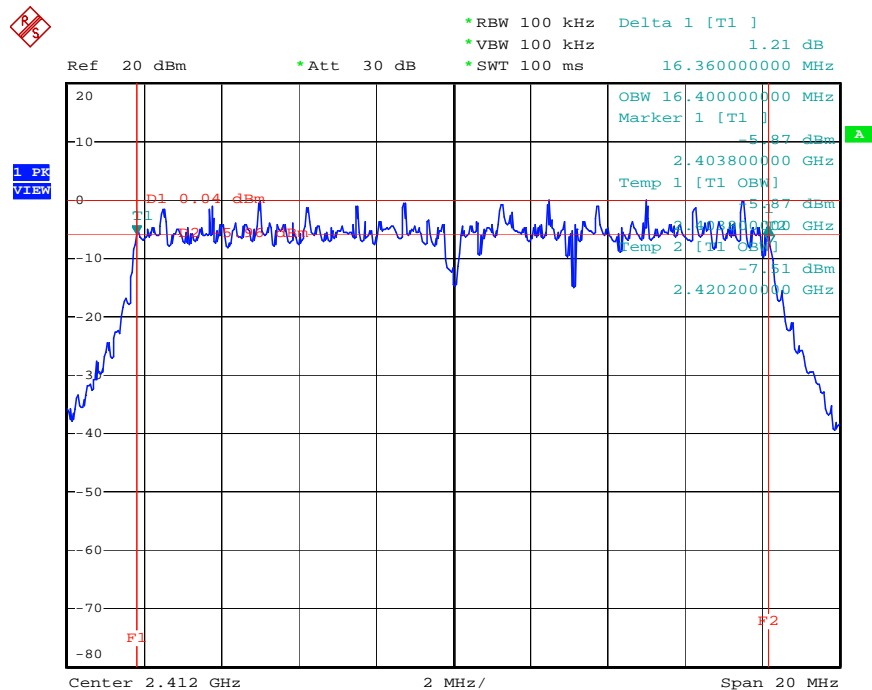

Date: 30.OCT.2006 10:49:50

### 6 dB Bandwidth Plot on Configuration IEEE 802.11g / 2437 MHz

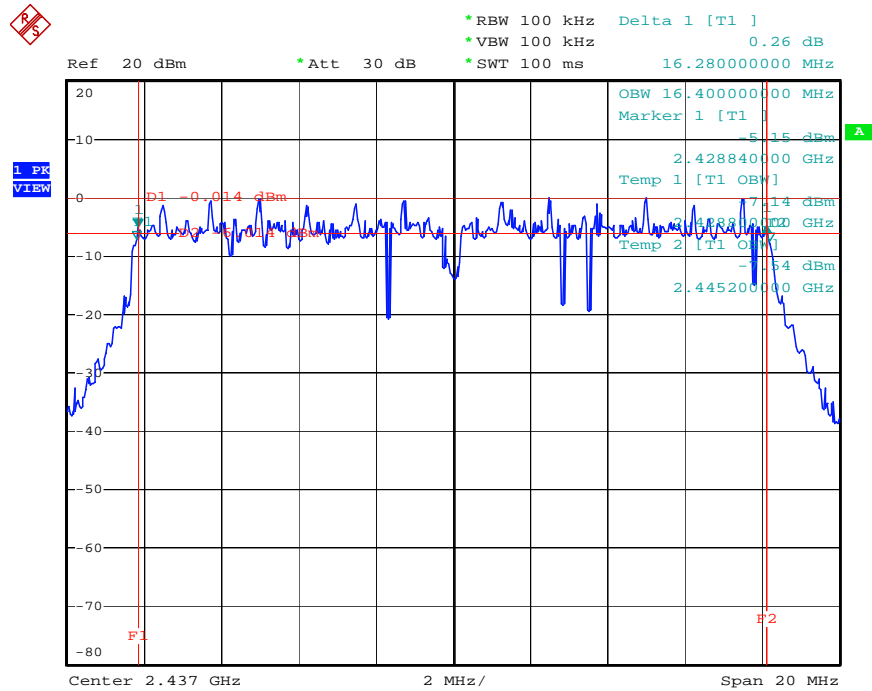

Date: 30.OCT.2006 10:51:28

### 6 dB Bandwidth Plot on Configuration IEEE 802.11g / 2462 MHz

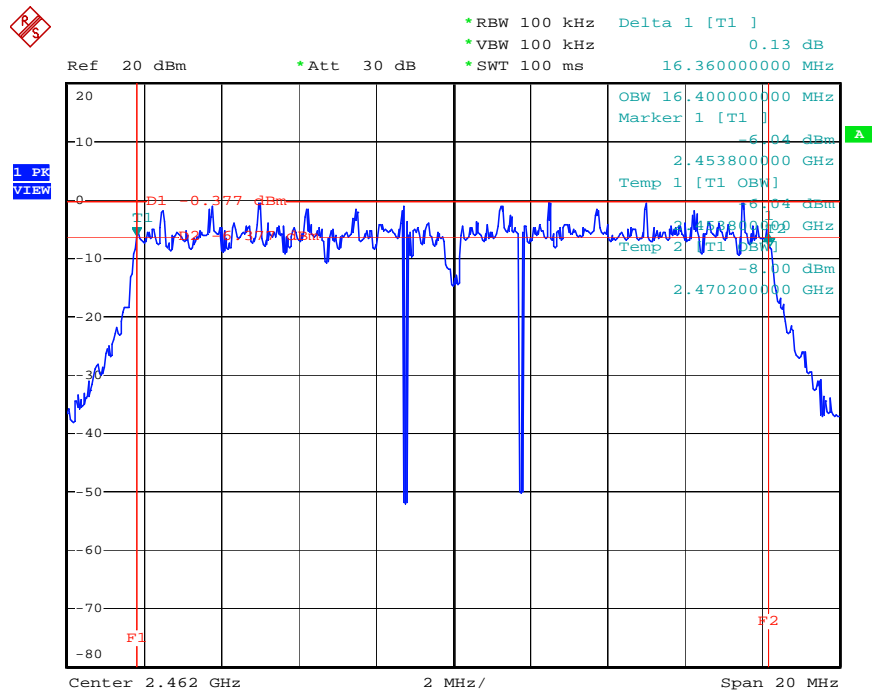

Date: 30.OCT.2006 10:53:15

## 4.5. Radiated Emissions Measurement

### 4.5.1. Limit

20dBc in any 100 kHz bandwidth outside the operating frequency band. In case the emission fall within the restricted band specified on 15.205(a), then the 15.209(a) limit in the table below has to be followed.

Frequencies (MHz)	Field Strength (micorvolts/meter)	Measurement Distance (meters)
0.009~0.490	2400/F(KHz)	300
0.490~1.705	24000/F(KHz)	30
1.705~30.0	30	30
30~88	100	3
88~216	150	3
216~960	200	3
Above 960	500	3

### 4.5.2. Measuring Instruments and Setting

Please refer to section 5 of equipments list in this report. The following table is the setting of spectrum analyzer and receiver.

Spectrum Parameter	Setting
Attenuation	Auto
Start Frequency	1000 MHz
Stop Frequency	10th carrier harmonic
RB / VB (Emission in restricted band)	1MHz / 1MHz for Peak, 1 MHz / 10Hz for Average
RB / VB (Emission in non-restricted band)	100KHz / 100KHz for peak

Receiver Parameter	Setting
Attenuation	Auto
Start ~ Stop Frequency	9kHz~150kHz / RB 200Hz for QP
Start ~ Stop Frequency	150kHz~30MHz / RB 9kHz for QP
Start ~ Stop Frequency	30MHz~1000MHz / RB 120kHz for QP

#### 4.5.3. Test Procedures

1. Configure the EUT according to ANSI C63.4. The EUT was placed on the top of the turntable 0.8 meter above ground. The phase center of the receiving antenna mounted on the top of a height-variable antenna tower was placed 3 meters far away from the turntable.
2. Power on the EUT and all the supporting units. The turntable was rotated by 360 degrees to determine the position of the highest radiation.
3. The height of the broadband receiving antenna was varied between one meter and four meters above ground to find the maximum emissions field strength of both horizontal and vertical polarization.
4. For each suspected emissions, the antenna tower was scan (from 1 M to 4 M) and then the turntable was rotated (from 0 degree to 360 degrees) to find the maximum reading.
5. Set the test-receiver system to Peak or CISPR quasi-peak Detect Function with specified bandwidth under Maximum Hold Mode.
6. For emissions above 1GHz, use 1MHz VBW and RBW for peak reading. Then 1MHz RBW and 10Hz VBW for average reading in spectrum analyzer.
7. When the radiated emissions limits are expressed in terms of the average value of the emissions, and pulsed operation is employed, the measurement field strength shall be determined by averaging over one complete pulse train, including blanking intervals, as long as the pulse train does not exceed 0.1 seconds. As an alternative (provided the transmitter operates for longer than 0.1 seconds) or in cases where the pulse train exceeds 0.1 seconds, the measured field strength shall be determined from the average absolute voltage during a 0.1 second interval during which the field strength is at its maximum value.
8. If the emissions level of the EUT in peak mode was 3 dB lower than the average limit specified, then testing will be stopped and peak values of EUT will be reported, otherwise, the emissions which do not have 3 dB margin will be repeated one by one using the quasi-peak method for below 1GHz.
9. For testing above 1GHz, the emissions level of the EUT in peak mode was lower than average limit (that means the emissions level in peak mode also complies with the limit in average mode), then testing will be stopped and peak values of EUT will be reported, otherwise, the emissions will be measured in average mode again and reported.
10. In case the emission is lower than 30MHz, loop antenna has to be used for measurement and the recorded data should be QP measured by receiver. High – Low scan is not required in this case.



#### 4.5.4. Test Setup Layout

For radiated emissions below 30MHz

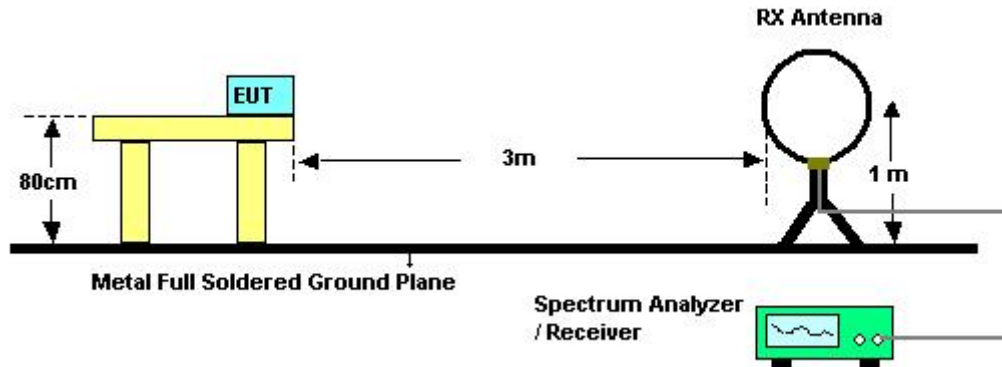

For radiated emissions above 30MHz

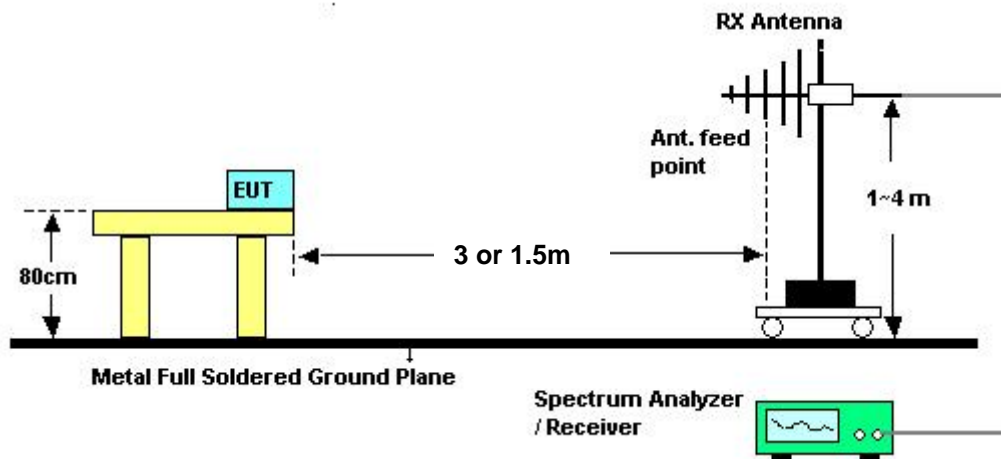

Above 10 GHz shall be extrapolated to the specified distance using an extrapolation factor of 20 dB/decade from 3m to 1.5m.

Distance extrapolation factor =  $20 \log (\text{specific distance [3m]} / \text{test distance [1.5m]})$  (dB);

Limit line = specific limits (dBuV) + distance extrapolation factor [6 dB].

#### 4.5.5. Test Deviation

There is no deviation with the original standard.

#### 4.5.6. EUT Operation during Test

The EUT was programmed to be in continuously transmitting mode.

#### 4.5.7. Results of Radiated Emissions (9kHz~30MHz)

<b>Temperature</b>	23°C	<b>Humidity</b>	63%
<b>Test Engineer</b>	Leo Hung	<b>Configurations</b>	802.11g CH 6

Freq. (MHz)	Level (dBuV)	Over Limit (dB)	Limit Line (dBuV)	Remark
-	-	-	-	See Note

Note:

The amplitude of spurious emissions that are attenuated by more than 20 dB below the permissible value has no need to be reported.

Distance extrapolation factor =  $40 \log(\text{specific distance} / \text{test distance})$  (dB);

Limit line = specific limits (dBuV) + distance extrapolation factor.

4.5.8. Results of Radiated Emissions (30MHz~1GHz)

Temperature	23°C	Humidity	63%
Test Engineer	Leo Hung	Configurations	802.11g CH 6 / Mode 1

Vertical

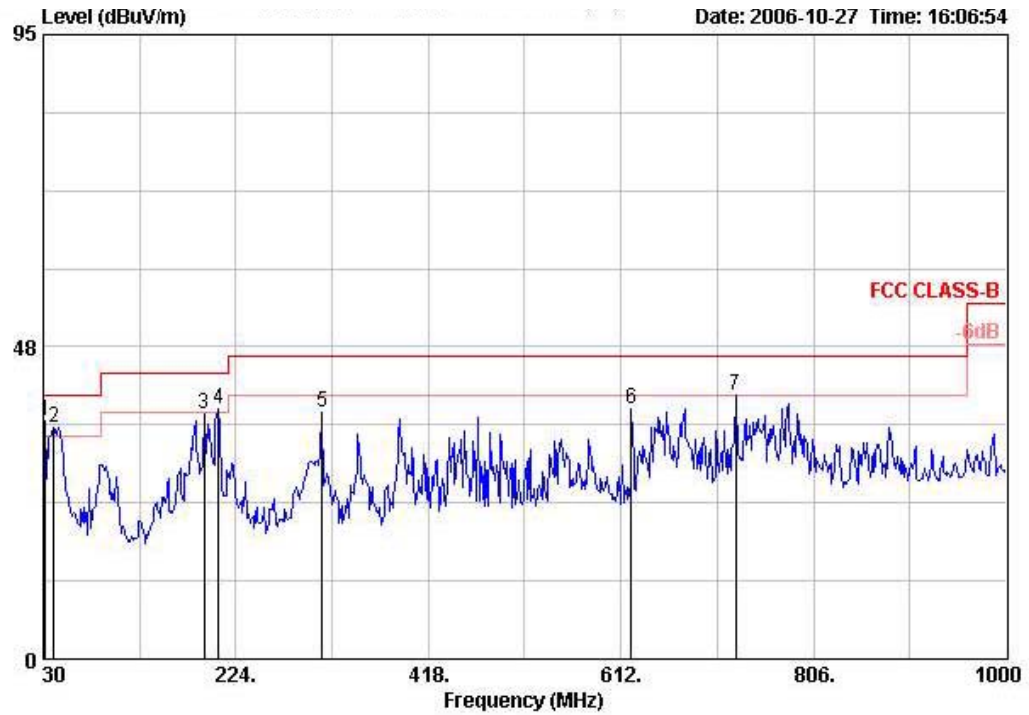

	Freq	Level	Over Limit	Limit Line	Read Level	Cable Loss	Preamp Factor	Remark	Ant Pos	Table Antenna Pos	Antenna Factor
	MHz	dBuV/m	dB	dBuV/m	dBuV	dB	dB		cm	deg	dB/m
1 !	31.940	36.19	-3.81	40.00	48.27	0.93	31.67	Peak	---	---	18.66
2 !	40.670	35.33	-4.67	40.00	52.59	1.10	31.77	Peak	---	---	13.40
3	191.990	37.15	-6.35	43.50	57.02	1.93	31.52	Peak	---	---	9.72
4 !	206.540	38.04	-5.46	43.50	56.98	2.04	31.43	Peak	---	---	10.45
5	311.300	37.63	-8.37	46.00	52.36	2.25	31.30	Peak	---	---	14.32
6	622.670	38.12	-7.88	46.00	46.06	3.28	30.55	Peak	---	---	19.33
7 !	727.430	40.10	-5.90	46.00	46.64	3.77	30.38	Peak	---	---	20.07

Horizontal

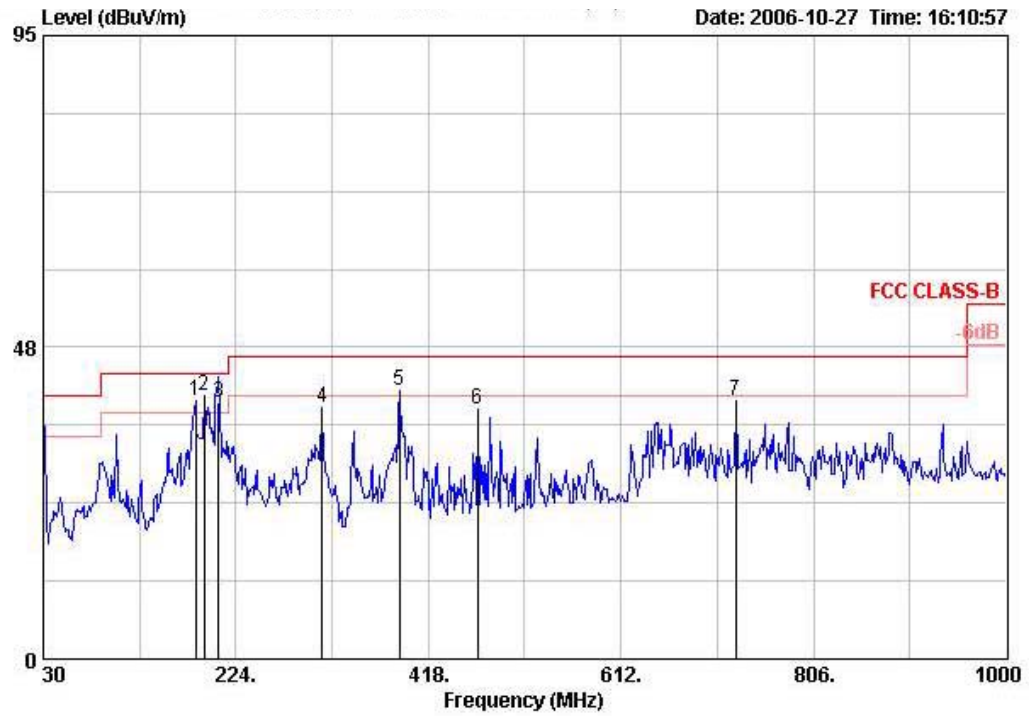

	Freq	Level	Over Limit	Limit Line	Read Level	Cable Loss	Preamp Factor	Remark	Ant Pos	Table Antenna Pos	Antenna Factor
	MHz	dBuV/m	dB	dBuV/m	dBuV	dB	dB		cm	deg	dB/m
1 !	183.260	39.35	-4.15	43.50	59.29	2.00	31.61	Peak	---	---	9.67
2 !	191.990	40.14	-3.36	43.50	60.01	1.93	31.52	Peak	---	---	9.72
3 !	206.540	39.17	-4.33	43.50	58.10	2.04	31.43	QP	174	353	10.45
4	311.300	38.29	-7.71	46.00	53.02	2.25	31.30	Peak	---	---	14.32
5 !	388.900	40.95	-5.05	46.00	53.05	2.63	31.08	Peak	---	---	16.34
6	467.470	38.15	-7.85	46.00	48.60	3.04	30.93	Peak	---	---	17.44
7	727.430	39.27	-6.73	46.00	45.81	3.77	30.38	Peak	---	---	20.07

Temperature	23°C	Humidity	63%
Test Engineer	Leo Hung	Configurations	802.11g CH 6 / Mode 2

Vertical

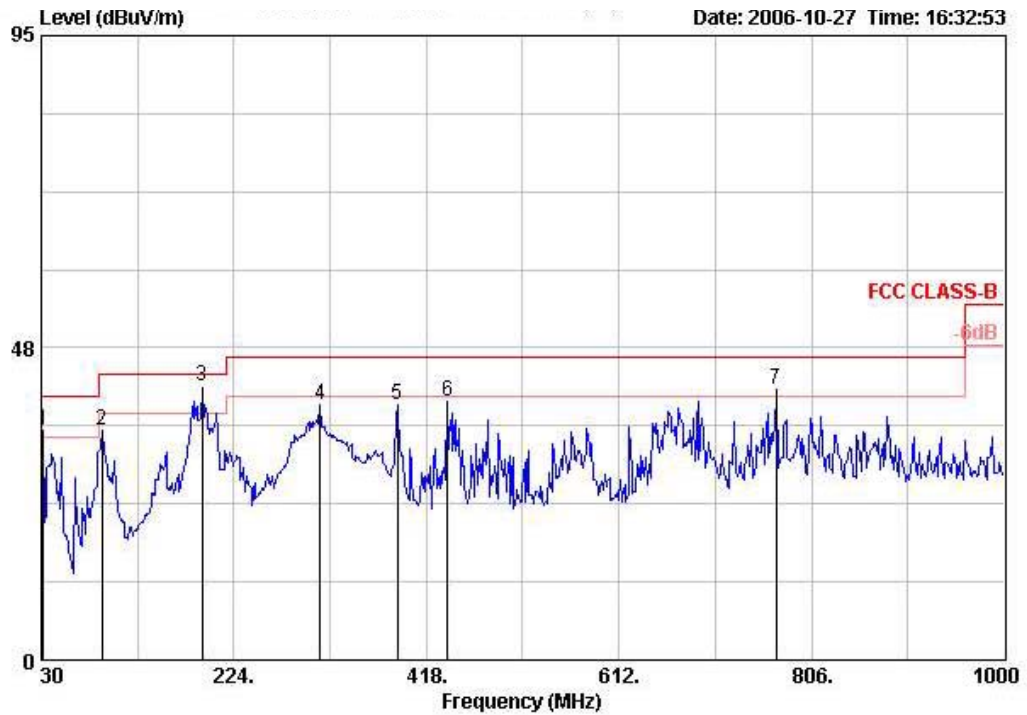

	Freq	Level	Over Limit	Limit Line	Read Level	Cable Loss	Preamp Factor	Remark	Ant Pos	Table Antenna Pos	Antenna Factor
	MHz	dBUV/m	dB	dBUV/m	dBuV	dB	dB		cm	deg	dB/m
1 !	31.940	34.92	-5.08	40.00	47.00	0.93	31.67	Peak	---	---	18.66
2	91.110	34.96	-8.54	43.50	55.54	1.43	31.59	Peak	---	---	9.58
3 Ⓜ	191.990	41.63	-1.87	43.50	61.50	1.93	31.52	QP	100	53	9.72
4	311.300	38.90	-7.10	46.00	53.63	2.25	31.30	Peak	---	---	14.32
5	388.900	38.96	-7.04	46.00	51.06	2.63	31.08	Peak	---	---	16.34
6	439.340	39.45	-6.55	46.00	50.46	2.86	30.94	Peak	---	---	17.07
7 !	770.110	41.13	-4.87	46.00	47.05	3.86	30.23	Peak	---	---	20.46

Horizontal

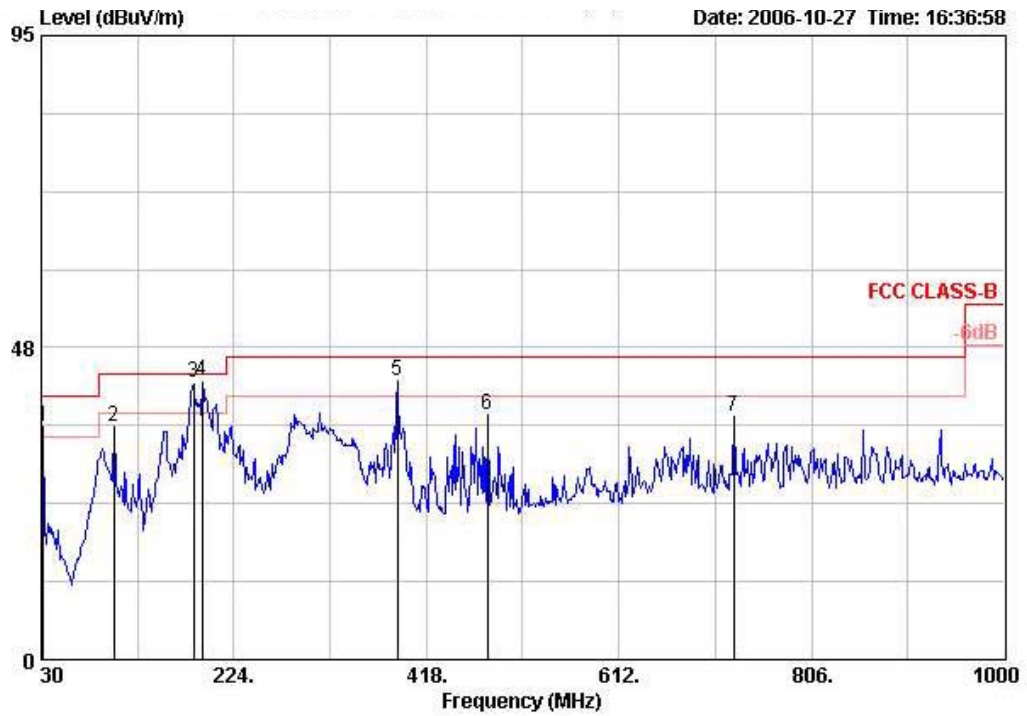

	Freq	Level	Over Limit	Limit Line	Read Level	Cable Loss	Preamp Factor	Remark	Ant Pos	Table Antenna Pos	Antenna Factor
	MHz	dBUV/m	dB	dBUV/m	dBuV	dB	dB		cm	deg	dB/m
1 !	31.940	35.43	-4.57	40.00	47.51	0.93	31.67	Peak	---	---	18.66
2	102.750	35.59	-7.91	43.50	54.13	1.50	31.72	Peak	---	---	11.68
3 @	183.260	42.26	-1.24	43.50	62.20	2.00	31.61	QP	174	345	9.67
4 @	191.990	42.43	-1.07	43.50	62.30	1.93	31.52	QP	184	161	9.72
5 !	388.900	42.46	-3.54	46.00	54.57	2.63	31.08	Peak	---	---	16.34
6	479.110	37.23	-8.77	46.00	47.43	3.13	30.93	Peak	---	---	17.60
7	727.430	37.07	-8.93	46.00	43.61	3.77	30.38	Peak	---	---	20.07

Temperature	23°C	Humidity	63%
Test Engineer	Leo Hung	Configurations	802.11g CH 6 / Mode 3

Vertical

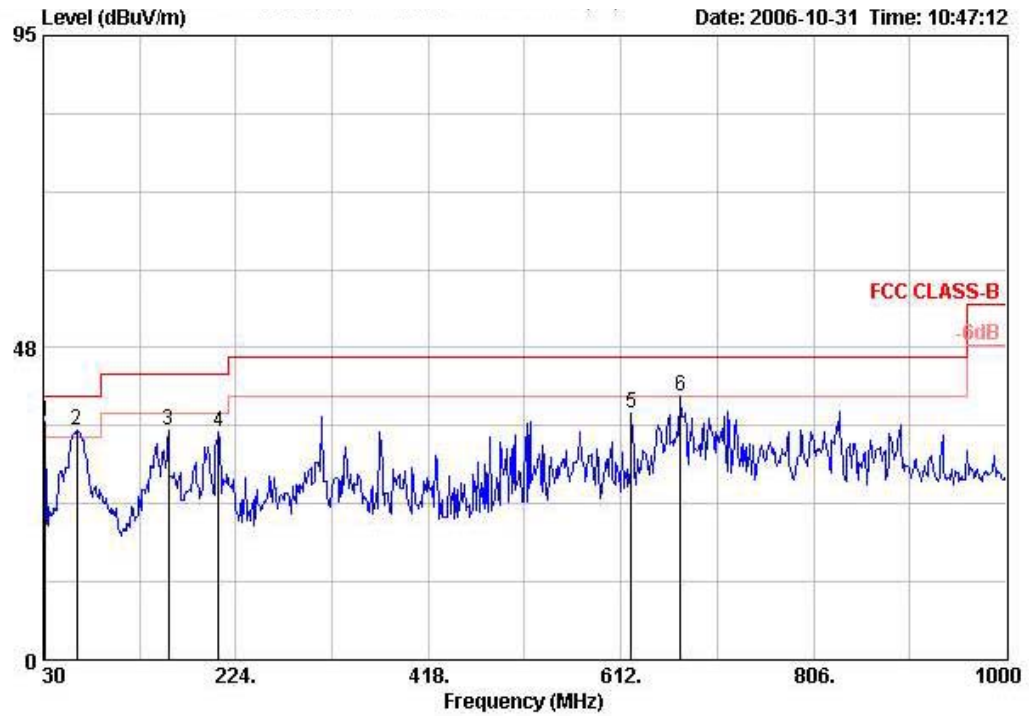

	Freq	Level	Over Limit	Limit Line	Read Level	Cable Loss	Preamp Factor	Remark	Ant Pos	Table Antenna Pos	Antenna Factor
	MHz	dBUV/m	dB	dBUV/m	dBuV	dB	dB		cm	deg	dB/m
1 !	31.940	36.33	-3.67	40.00	48.41	0.93	31.67	Peak	---	---	18.66
2 !	63.950	34.98	-5.02	40.00	58.87	1.33	31.82	Peak	---	---	6.60
3	156.100	34.89	-8.61	43.50	53.64	1.93	31.52	Peak	---	---	10.84
4	206.540	34.80	-8.70	43.50	53.73	2.04	31.43	Peak	---	---	10.45
5	622.670	37.47	-8.53	46.00	45.41	3.28	30.55	Peak	---	---	19.33
6 !	672.140	40.05	-5.95	46.00	47.22	3.54	30.40	Peak	---	---	19.69

Horizontal

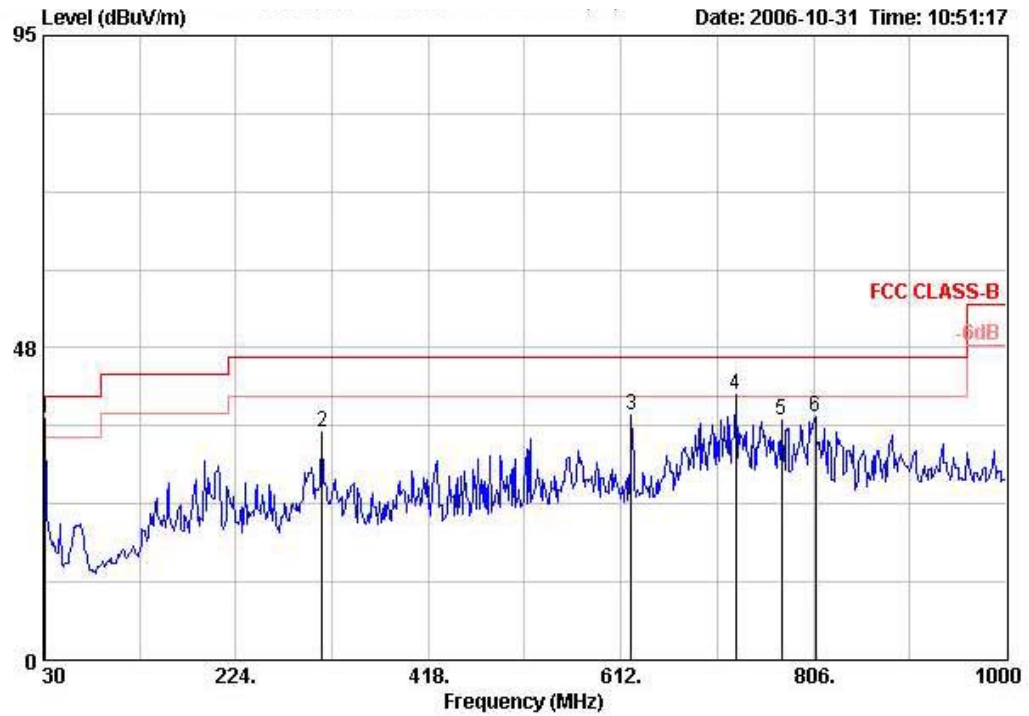

	Freq	Level	Over Limit	Limit Line	Read Level	Cable Loss	Preamp Factor	Remark	Ant Pos	Table Antenna Pos	Antenna Factor
	MHz	dBUV/m	dB	dBUV/m	dBuV	dB	dB		cm	deg	dB/m
1 !	31.940	36.67	-3.33	40.00	48.75	0.93	31.67	Peak	---	---	18.66
2	311.300	34.75	-11.25	46.00	49.48	2.25	31.30	Peak	---	---	14.32
3	622.670	37.15	-8.85	46.00	45.09	3.28	30.55	Peak	---	---	19.33
4 !	727.430	40.47	-5.53	46.00	47.01	3.77	30.38	Peak	---	---	20.07
5	773.990	36.52	-9.48	46.00	42.41	3.85	30.23	Peak	---	---	20.49
6	807.940	37.03	-8.97	46.00	42.58	3.83	30.17	Peak	---	---	20.79



Temperature	23°C	Humidity	63%
Test Engineer	Leo Hung	Configurations	802.11g CH 6 / Mode 4

Vertical

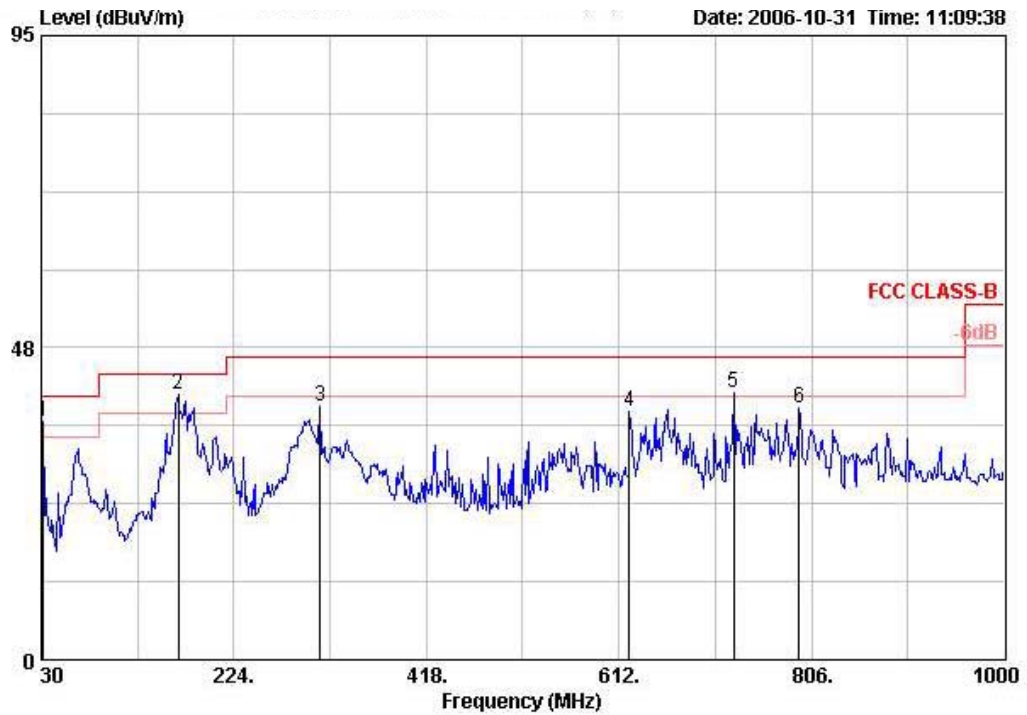

	Freq	Level	Over Limit	Limit Line	Read Level	Cable Loss	Preamp Factor	Remark	Ant Pos	Table Antenna Pos	Antenna Factor
	MHz	dBUV/m	dB	dBUV/m	dBuV	dB	dB		cm	deg	dB/m
1 !	31.940	36.24	-3.76	40.00	48.32	0.93	31.67	Peak	---	---	18.66
2 @	167.740	40.40	-3.10	43.50	59.70	1.90	31.56	Peak	---	---	10.36
3	311.300	38.55	-7.45	46.00	53.29	2.25	31.30	Peak	---	---	14.32
4	622.670	37.92	-8.08	46.00	45.86	3.28	30.55	Peak	---	---	19.33
5 !	727.430	40.69	-5.31	46.00	47.23	3.77	30.38	Peak	---	---	20.07
6	793.390	38.40	-7.60	46.00	44.14	3.81	30.19	Peak	---	---	20.65

Horizontal

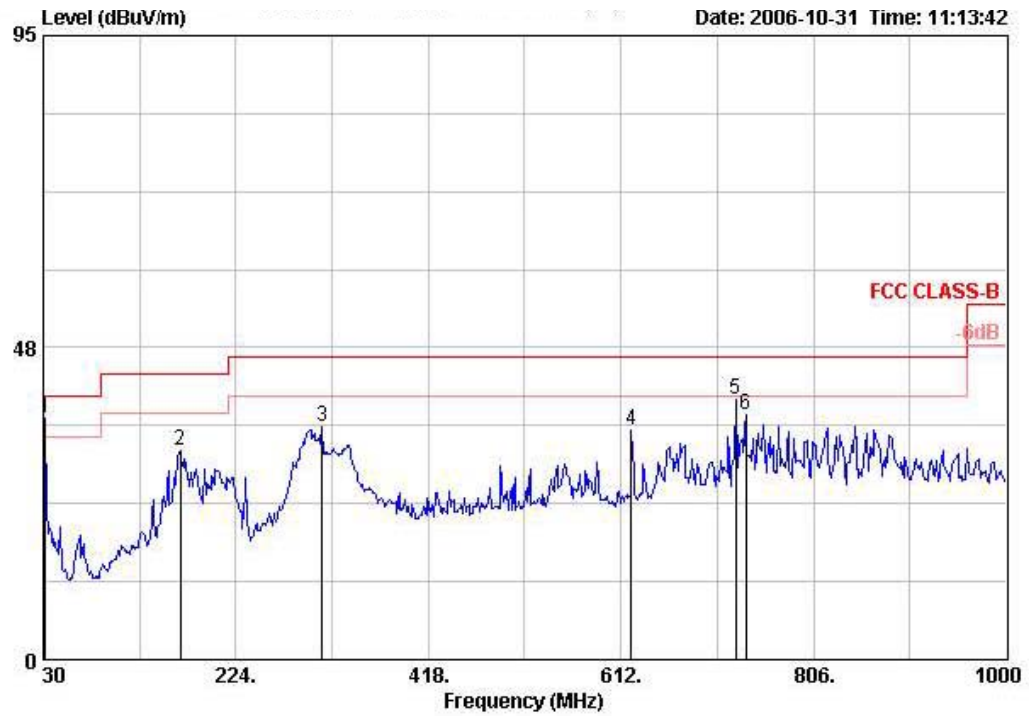

	Freq	Level	Over	Limit	Read	Cable	Preamp	Remark	Ant	TableAntenna
	MHz	dBuV/m	Limit	Line	Level	Loss	Factor		Pos	Pos Factor
			dB	dBuV/m	dBuV	dB	dB		cm	deg dB/m
1	31.940	36.87	-3.13	40.00	48.95	0.93	31.67	Peak	---	18.66
2	167.740	31.77	-11.73	43.50	51.07	1.90	31.56	Peak	---	10.36
3	311.300	35.53	-10.47	46.00	50.26	2.25	31.30	Peak	---	14.32
4	622.670	34.88	-11.12	46.00	42.82	3.28	30.55	Peak	---	19.33
5	727.430	39.72	-6.28	46.00	46.26	3.77	30.38	Peak	---	20.07
6	738.100	37.22	-8.78	46.00	43.54	3.83	30.33	Peak	---	20.18