

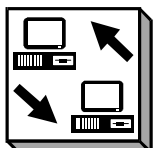

HBC – Radio Control

eco L Radio Transmitter

for Mobile Hydraulic Applications

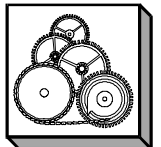
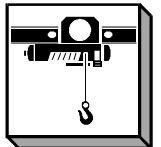
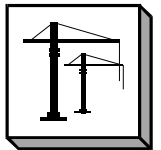
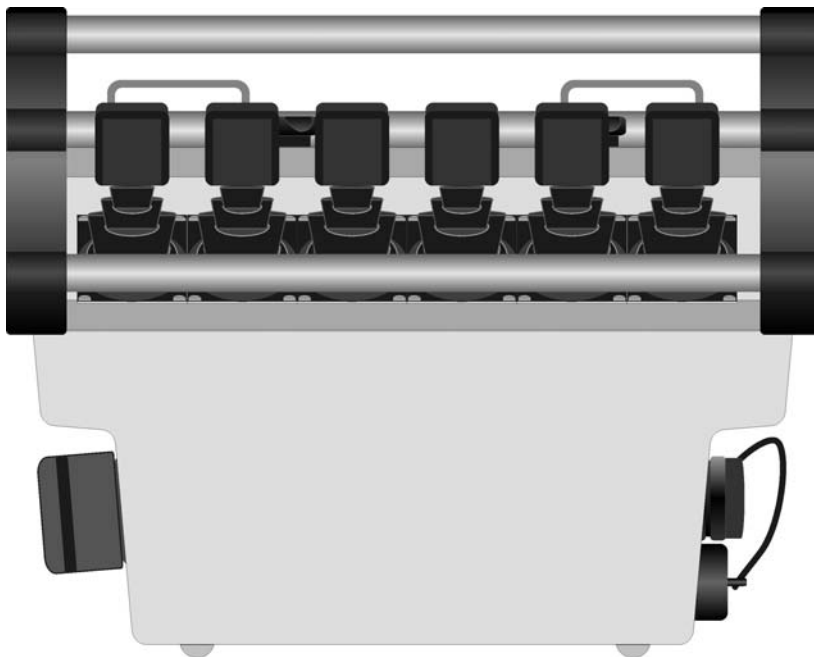



Manufacturer : HBC-radiomatic GmbH
Haller Strasse 49 - 53
74564 Crailsheim • GERMANY
Tel. +49 (0) 79 51 – 3 93 - 0
Fax +49 (0) 79 51 – 3 93 – 50
E-mail: info@radiomatic.com
<http://www.hbc-radiomatic.com>

HBC radiomatic GmbH is not liable for any misprints or errors! – All rights reserved.

™ *radiomatic* is a registered German trademark.

© 2003 – 02 , HBC-radiomatic GmbH , 74564 Crailsheim , GERMANY

No part of any software or of the present document may be reproduced in any manner whatsoever without the expressed written permission of HBC-radiomatic GmbH.

Table of Contents

1	Description	4
2	Safety Instructions	5
2.1	Pictographs.....	5
2.2	General Safety Instructions	6
2.3	Operator Safety Instructions	7
3	Operation	8
	Automatic Switch-OFF (APO Function)	9
	Enabling of the Proportional Outputs	9
	Utilization of the START Key as "shift" Key.....	9
3.1	Special Operating Elements and Functions	10
3.1.1	"SCANNER" Rotary Switch (Frequency Selector).....	10
3.1.2	"4 Speeds" Rotary Switch	10
3.2	Battery and Battery Charger	11
3.2.1	FuB 05 AA Transmitter Battery	11
3.2.2	FLG 105 Battery Charger.....	11
3.3	Special Operating Modes (Optional).....	12
3.3.1	Cable Control Option.....	12
3.3.2	<i>tele-teach-in</i> Battery TTB 05 Option.....	13
4	Fault Correction	15
5	Maintenance	16
5.1	In the Event of a Fault.....	16
6	Technical Data	17
6.1	Dimensions and Operator Controls of eco L	18
7	Certificates and Approvals.....	19

1 Description

The eco L transmitter is designed to transmit command instructions for controlling small and medium loading cranes, hoists and working machines in construction and industry.

Depending on the type and version selected, up to 6 control commands plus the integrated STOP commands are available to the operator.

A non-interchangeable system address ensures the functional safety of the radio control system when operating cranes or machines. This feature is particularly important when several cranes or machines are in use, for example in halls and shops. The system address is exclusively allocated to each HBC radio transmitter and its respective receiver.

It is not possible to activate crane or machine functions using a radio control system allocated to another crane or machine.

The radio control system consists of the eco L radio transmitter, two rechargeable NiCd batteries, a battery charger and a receiver with external antenna. The transmitter housing with integrated antenna is made of glass-fiber reinforced ABS plastic.

The transmitter is powered by 2 rechargeable NiCd batteries. The batteries and memory effect-free battery charger are included.

High-quality radio technology in compliance with the current European guidelines and the relevant regulations regarding on-the-job safety and accident prevention as well as the use of mature microprocessor-based technology guarantee optimal safety of operation, high availability and a long service life.

In most European Union countries, the radio transmitter and accompanying receiver can be operated free of charge – please observe the appropriate national regulations. To be operated free of charge, the transmitter must be operated in the frequency ranges from 433,100 MHz to 434,750 MHz or 869 MHz to 870 MHz and with a transmitting power of, typically, <5 to <10 mW. Operation in other frequency ranges and / or with a different transmitting power is only allowed with the authorization of the responsible authorities.

Operating the radio transmitter using different frequency ranges or transmitting powers requires the approval of the competent regulative authorities for telecommunication.

The following radio receivers may be used in conjunction with the eco L transmitter :

FSE 717

Note :



Changes or modifications not expressly approved by the party responsible for compliance could void the user's authority to operate the equipment.

2 Safety Instructions

2.1 Pictographs

The following pictographs will be used throughout the present operating instructions :



Indicates a possible shock hazard

Contacting components under voltage may lead to death. Housing (e. g. hoods and lids) marked with this symbol may only be opened by qualified electricians after having disconnected the device from the mains supply (supply voltage, operating voltage or input terminal voltage).



Indicates safety relevant passages

You will find this pictograph as an indicator for occupational safety measures. The neglecting of such measures poses a serious hazard. Always observe the instructions and be particularly attentive and careful. Avoid any situations that could at any time be a danger to persons or machines.



Indicates important information

This symbol brings your attention to important information on how to secure a long serviceable life of the radio control system. Pay attention to the comments and instructions given. Ignoring the information provided may permanently impair the reliability and operability of the equipment.

2.2 General Safety Instructions

Radio controls facilitate and increase the operating efficiency of construction cranes. Nevertheless, the operator must thoroughly understand and be in a position to properly use a radio control system !

- Read the Operating Instructions Manual carefully and thoroughly before working with the radio transmitter for the first time !
- The operator undertakes to strictly adhere to the instructions and proceedings described in this manual, as well as to follow the general rules and regulations for worker safety and accident prevention. Ignoring any such instructions or regulations could pose a fatal threat to the operator or others.
- Keep this manual on location and readily available at all times !
- Only authorized and properly trained personnel may operate the radio transmitter.
- Anyone who is under the influence of drugs, alcohol or medication that has a negative effect on a person's reactions may at no time commission, operate, maintain or repair the radio transmitter.
- Before switching the radio transmitter on ensure that no-one is or can be endangered by the initiated operation.
- With the first signs of any malfunction related to the operative safety and reliability of the radio transmitter, the operator must immediately shut down or not activate the transmitter. For the purpose of the present manual "shut down" implies :
 - switching OFF the transmitter,
 - storing the transmitter in a safe place and ensuring no unauthorized access,
 - de-energizing the receiver and
 - unplugging the connection cable on the receiver !
- Defects must be repaired and objects of interference must be removed immediately !
- Only qualified and competent personnel are permitted to repair a defective transmitter. Use original HBC spare parts only ! The use of any other spares will render the technical inspectorate approval invalid as well as substantially impede operative safety.
- Observe all periodical tests and inspections that are required by law or recommended in the present operating instructions !
- When using the eco L radio transmitter always observe the regulations and instructions stipulated in the authoritative worker's safety and accident prevention regulations (e. g. VBG 9).
 - The eco L radio transmitter has been manufactured in accordance with the regulations and guidelines stipulated in the German Trade Association's "Safety and Accident Prevention Regulations for Operating Cranes by Radio Controls" (VBG 9) and pr EN 12077-1.
 - The eco L radio transmitter has been tested and approved in accordance with EMC guidelines and complies with the authoritative standards for emitted interference and interference immunity.
- Use the transmitter carefully and solely for its intended use. In particular when using a transmitter to radio control a crane for the first time.



2.3 Operator Safety Instructions

- Before beginning crane operation, position yourself so that you have a clear and complete overview of the working radius of the crane or machine.
- Use the enclosed belt-clip to carry the transmitter. To operate, hold the transmitter securely in your hand. Use the optional wrist strap. Follow these instructions to ensure personal safety.
- Depending on your angle or position to the crane or machine, the transmitter control commands "trolley left" and "trolley right" appear to interchange ! It is essential that you take your bearings to the crane or machine into due consideration before operating equipment.
- In case of an emergency or any disturbances within the working range of the crane or machine, switch the transmitter off immediately by pressing the STOP pushbutton. Should the transmitter show signs of technical failure or breakdown, disconnect the radio control system immediately !
- Always switch OFF the transmitter during breaks and after finishing work to avoid operating errors or any accidental actuation of operator controls.
 - These precautions are particularly important whenever changing your position or climbing over an obstacle.
- Never leave an activated transmitter unattended. The operator undertakes to follow and comply with the authoritative regulations for worker safety and accident prevention (e. g. VBG 9).



Note :

- In the event of an interruption of the radio link during a working cycle – what can occasionally happen – both transmitter and receiver automatically shut down (so-called "**compulsory switch-off**").
To reactivate the system release all operator controls, such as pushbuttons or momentary contacts, and allow the control elements to return to their zero position. Press the "ON/Horn" pushbutton. The system must be reactivated before the crane or machine can react to control commands ! This feature hinders any uncontrolled or unwanted crane or machine movement, should the radio link be interrupted.
- When operating a crane by means of a radio control system for the first time, you may miss the physical contact to the crane that you were used to in the operating stand. As you are no longer in the crane and can no longer sense the starting of the crane movements as distinctly, crane reactions will appear sluggish or dull.

3 Operation



Caution :

The operation of the transmitter is permissible only with the carrying set included with the transmitter (possibility of mixing up the controls) !

1. Before commissioning the transmitter or initial operation, insert the fully charged battery (inscription must be visible) into battery compartment (pos. ①) at the bottom of the transmitter. The battery supplies the voltage required for the operation of the transmitter (6 V DC).
2. Turn STOP pushbutton (pos. ②) to unlock.
3. Turn key switch (pos. ③) to the right (position "1").
4. Switch ON transmitter and crane or machine with "ON" pushbutton. The dual color LED flashes **green**, i.e. the transmitter is operable.

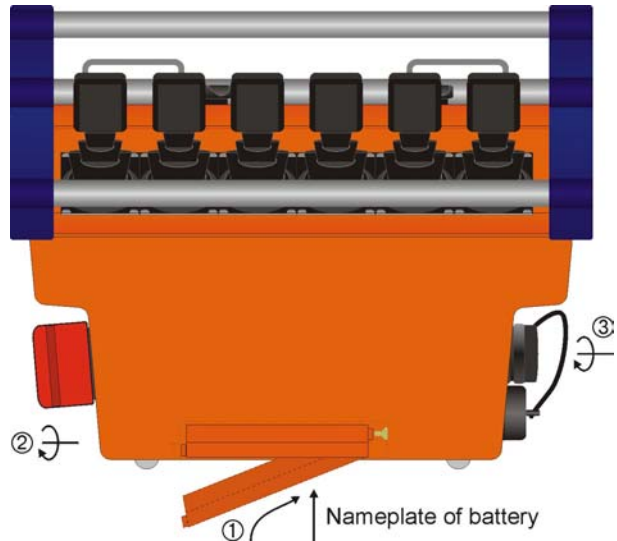

Important Information :

After switching ON the transmitter **and before** operating the crane or machine you must always :

- trigger the acoustic signal by pressing the "Horn" pushbutton. This warns all colleagues that the crane or machine is about to move;
- test the operativeness of the STOP pushbutton.

A radio connection to the receiver is established when the red LED "HF/RF/H.F./HF" on the receiver will be extinguished and the green LED "Si1" is illuminated (refer to radio status panel of the receiver), i.e. the radio system is ready to operate and the control commands may be input via the operator controls of the transmitter.

If the dual color LED on the transmitter **flashes red** and / or an acoustic signal comes, this indicates that the battery is almost fully discharged. **Now**, you must replace the discharged battery by a charged one and recharge the discharged battery (refer to chapter "Battery and Battery Charger").



Note :

If the discharged battery is not replaced by a charged one, the transmitter will be automatically switched OFF after a few minutes.

Should the operator – intentionally or unintentionally – switch OFF the transmitter with the STOP pushbutton, following steps have to be carried out for further radio transmission :

1. Switch OFF the transmitter via the key switch (switch position "0").
2. Unlock the STOP pushbutton by turning.
3. Switch the transmitter ON again via the key switch (switch position "1").
4. Switch ON transmitter and crane or machine with "ON" pushbutton.



Note :

Always use the key switch to switch the transmitter ON or OFF. **Do not** use the STOP pushbutton !

Automatic Switch-OFF (APO Function)

For safety reasons we have equipped the transmitter with an automatic switch-OFF (APO = **A**utomatic **P**ower **O**ff function). The transmitter is automatically put out of circuit after 15 minutes of non-use.

The automatic switch-OFF also saves battery power.



Note :

The automatic switch-OFF (APO function) **does not relieve** the operator of his responsibility to turn OFF the transmitter when not in use !

The transmitter can be reactivated by means of the "ON" pushbutton.

Enabling of the Proportional Outputs

The "START" key must be depressed after the system has been activated and enabled via S1 (at the receiver). It is not until this has been done that the functions of the compact joysticks at the receiver will be enabled.

Utilization of the START Key as "shift" Key

The "RPM+" and "RPM-" keys have a dual function.

If the "START" key is kept depressed and the "RPM+" resp. "RPM-" key is also activated, the "motor start" resp. "motor stop" command will be output.

3.1 Special Operating Elements and Functions

3.1.1 "SCANNER" Rotary Switch (Frequency Selector)

The transmitter and receiver are equipped with a "Scanner" (frequency selector) operating mode with 4 radio frequencies (refer to wiring diagrams).

In the event that the momentarily used radio channel is being used by another operator, the transmitter can be switched over to a different channel by means of the rotary switch SCANNER (fig. right, pos. ①). The receiver scanner automatically adjusts the receiver to the selected radio frequency.



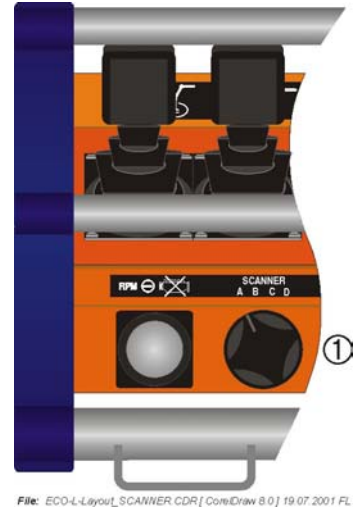

After turning ON the transmitter (set key switch to "ON" position and do not forget to unlock STOP pushbutton), the receiver automatically resets the system to the new frequency selected in less than a second.



3.1.2 "4 Speeds" Rotary Switch

4 maximum speeds of the crane may be adjusted using the rotary switch (fig. right, pos. ①).

The symbols for the speed adaptation have the following meanings :

-  = maximum speed , 100 %
-  = maximum speed , limited to 75 %
-  = maximum speed , limited to 50 %
-  = maximum speed , limited to 25 %



3.2 Battery and Battery Charger

3.2.1 FuB 05 AA Transmitter Battery

The age and ambient temperature are decisive for the length of the battery applications. Older batteries lose capacity over time. Temperatures under zero also have a negative effect on battery charge.

The length of serviceable battery life depends on how the battery is treated. When handled properly the FuB 05 AA battery can exceed 500 charging cycles. Do not totally discharge or short-circuit contacts as this can permanently destroy the battery.

We recommend recharging the battery only when it is empty, i.e. when the dual color LED on the transmitter flashes red or an acoustic signal sounds.

Always store rechargeable batteries at room temperature (20 °C or 68 °F).



3.2.2 FLG 105 Battery Charger

Recharging batteries

1. Connect battery charger to mains (refer to nameplate on battery charger for details).
2. Insert battery with the nameplate facing up into the battery compartment (pos. ②).

Charging indicator (red LED ; pos. ①)

LED lit : battery charging.
 LED off or flashing : battery full, i.e. operable.
 LED flashes when inserting battery : battery totally discharged or defective.



Notes :

- A discharged FuB 05 AA battery recharges in approx. 4 hours. Electronics in the battery charger ensure that charging does not exceed 5 hours.
- The quick charging of NiCd batteries should only take place at temperatures between +10 °C and +40 °C (50 °F and 104 °F).
- Protect battery contacts against short circuits. Never store batteries in a tool box or trouser pockets. A bunch of keys is enough to short the battery. Always use the protective cap included.
- Use the charger at room temperature (20 °C or 68 °F) and protect it from extreme heat (direct sun).



3.3 Special Operating Modes (Optional)

**Note :**

This chapter describes special operating modes that are not available with all radio control systems.

If your radio control system is not equipped with the features described, you may ignore the following and continue with the next chapter.

3.3.1 Cable Control Option

With the cable control option the operator can also control his crane or machine without using radio control

He merely has to connect the receiver mounted on his crane or machine to the cable control connection (fig. on the right, pos. ①) on the transmitter via a cable (standard length 20 m to max. 100 m).

The cable connection between the transmitter and receiver can be made when the radio system is active. After the transmitter has been connected to the receiver via the cable, the transmitter **must be** restarted by pressing the "START" pushbutton

**Note :**

If the transmitter is connected with the receiver via cable, the transmitter module in the transmitter automatically switches off.

3.3.2 *tele-teach-in* Battery TTB 05 Option

The eco L radio control features together with the FSE 717 radio receiver the so-called *tele-teach-in* option.

This specific function allows you to input and store the minimum as well as maximum speeds assigned to the individual linear lever functions in a simple manner.

The *tele-teach-in* option is available for all proportional functions (linear lever commands).



Important note :

Your radio control system was already adapted to your specific crane by a retailer respectively the manufacturer.

Should the crane movements nevertheless be executed in a jerky manner or too fast, then please contact your retailer or the manufacturer in order to have the settings adapted.

In the following, the programming of the minimum and maximum speeds of the individual control functions will be described by means of *tele-teach-in*.

The programming keys ("+" and "-") are located on the TTB 05 *tele-teach-in* battery (see fig. right).



Note :

Please read the instructions at hand completely and carefully before beginning with the programming !



Programming

1. Switch OFF the transmitter.
2. Insert a charged TTB 05 *tele-teach-in* battery into the transmitter.
3. Depress the programming keys "+" and "-" simultaneously and then switch ON the transmitter. Keep the programming keys depressed until the green service LED of the transmitter starts flashing quickly. Now, the control is in the *tele-teach-in* mode.
4. Setting the minimum speed (fig. right)

Push the linear lever toward the desired function.

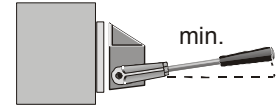

Note :

Do not move the linear lever beyond 50 % of the maximum lever travel.

Then adjust the minimum speed by means of the "+" and "-" keys, i.e. by looking for the minimum point when the hydraulic valve begins to react. It will be helpful to observe the way the function is carried out as well as the movement of the lever of the hydraulic valve.

5. Setting the maximum speed (fig. right)

Push the linear lever toward the desired function by moving it to its end position. Then adjust the maximum speed by means of the "+" and "-" keys, i.e. by looking for the maximum point when the hydraulic valve begins to react. In order to make use of the full lever travel of the linear lever, do not actuate the "+" key any longer after the hydraulic valve has reached its maximum travel.

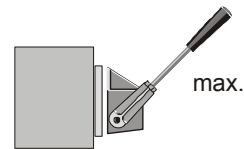

Note :

In the *tele-teach-in* mode, only execute one single function at the time, not all linear levers in a diagonal way, as it is only possible to program one single function at the time.

For all further linear lever functions, please repeat the steps beginning with item 3.

In order to verify the programmed settings, switch OFF the transmitter and then switch it ON afterwards. Now, the transmitter is again in the normal operating mode.

In case of systems that offer creeping function, all the functions will have to be programmed again in the creeping mode (switch set to the snail symbol).

4 Fault Correction



Note :

Please check the transmitter functions using the cabin or cable controls first !

Problem	Possible Cause	Remedy
The transmitter does not react when switched on.	<ul style="list-style-type: none"> – There is no power. 	<ul style="list-style-type: none"> – Check the battery contacts for damage or contamination. – Insert a fully charged battery into the battery compartment. – Recharge the battery.
Low-power indication after minimal operating time, i.e. the dual color LED on the radio transmitter illuminates red.	<ul style="list-style-type: none"> – The battery contacts are contaminated or damaged. – The battery is not charged. – The battery is defective. 	<ul style="list-style-type: none"> – Check the battery contacts for damage or contamination. – Fully recharge the battery. – Ensure that the recharging process runs correctly. – Check the transmitter functions using a fully charged or replacement battery.

5 Maintenance

The radio control system is virtually maintenance-free. The following points, however, should be taken into consideration :

- Ensure that the STOP pushbutton works smoothly.
Mortar residue and contaminants of any kind can reduce or fully block the switch function.
- Inspect the rubber bellows of the linear levers regularly for leak-tightness.
Replace immediately if cracks appear since the penetration of dirt and humidity may damage the function of the linear levers.
- Charge and discharge transmitter batteries regularly.
- **Never** use a high-pressure cleaner or steam jet cleaner to "clean" the transmitter.
Use a soft brush or cloth only !



Note :

Should you have any problems with your radio control system, contact your local distributor or HBC-radiomatic GmbH.

5.1 In the Event of a Fault



Warning :

Never operate a crane or machine with a faulty or defective radio control system !

- Never try to repair the transmitter electronics ! Opening the transmitter housing terminates the manufacturer guarantee.
 - Send any defective or faulty equipment to you local distributor or to the manufacturer. They are experts and have the necessary know-how and OEM spare parts.
 - Always send both transmitter **and** receiver and enclose a detailed description of the problem.
 - Do not forget to enclose your address and telephone number so that we can get in touch with you quickly if necessary.
- To avoid damage during transport, use the original packing supplied with the transmitter and receiver, otherwise pack securely. Send the consignment to your distributor or to the following address :
 - HBC-radiomatic GmbH
 - Haller Strasse 49 – 53
 - 74564 Crailsheim • GERMANY
- Should you chose to deliver a defective radio control system personally to your distributor or our factory, please call and arrange an appointment.
 - HBC-radiomatic GmbH
 - Customer Services / Repair Service –
 - Tel.: +49 (0) 79 51 – 3 93 - 816

6 Technical Data

General Technical Data	
<i>System</i>	radio transmitter
<i>Type of system</i>	eco L
<i>Max. number of control commands</i>	6
<i>Unique system address</i>	over 65,000 combinations
Transmitter Specific Technical Data	
<i>Transmitting power with FuS 671/3: or FuS 680/3:</i>	< 10 mW (synthesizer) < 5 mW (synthesizer)
<i>Transmitter antenna</i>	internal
<i>Battery type standard :</i> <i>with tele-teach-in :</i>	FuB 05 AA (orange) TTB 05 (orange)
<i>Power supply with NiCd battery</i>	6 V DC / 600 mAh
<i>Battery charge at 50 % duty cycle :</i> <i>100 % duty cycle :</i>	8 hours 4 hours
<i>Operating temperature range</i>	-25 °C ... +75 °C (-13 °F ... +167 °F)
<i>Housing material</i>	glass-fiber reinforced ABS plastic
<i>Housing color lower part :</i> <i>roll-over bar :</i>	orange blue
<i>Dimensions</i>	216 x 126 x 176 mm (8.5 x 4.9 x 6.9 ")
<i>Weight</i>	approx. 2,0 kg (4.4 lb.)
<i>Protection class</i>	IP 55

6.1 Dimensions and Operator Controls of eco L

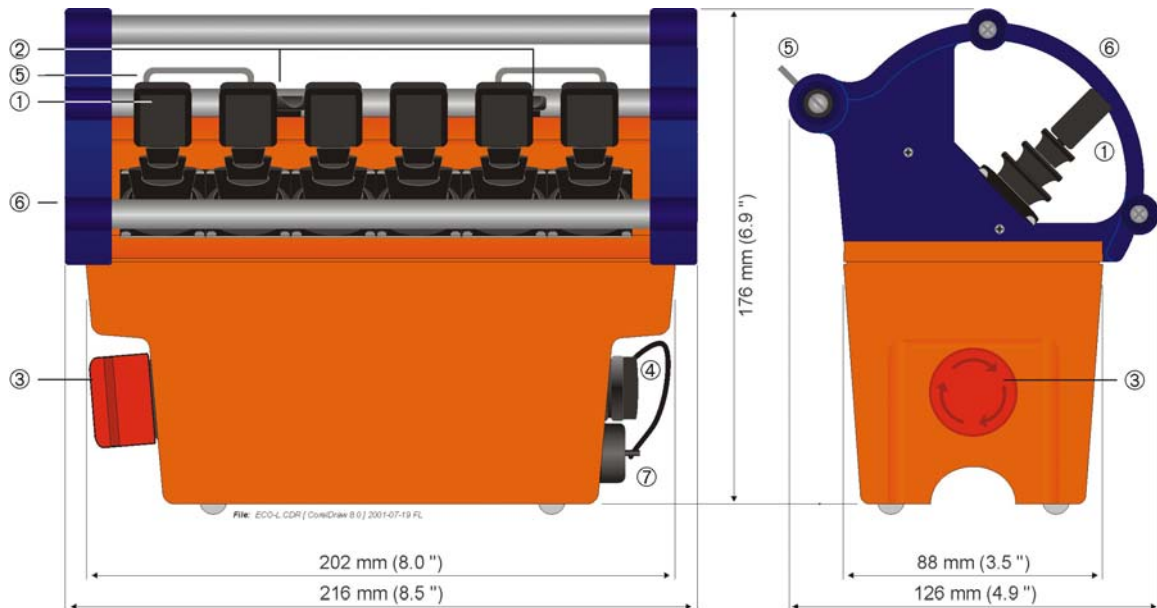

- ① 6 linear levers
- ② 2 selector switches
- ③ STOP pushbutton
- ④ Key switch "ON / OFF"
- ⑤ Loop for carrying belt
- ⑥ Roll-over bar
- ⑦ Protection cap for cable control connector



7 Certificates and Approvals

EC Declaration of the Manufacturer and of Conformity

according to EC Directives for Machinery 98/37/EG , Appendix II B

We,

HBC-radiomatic GmbH
Haller Strasse 49-53 • 74564 Crailsheim • GERMANY

hereby certify that the following products



Radio Control Transmitter orbit, vector, patrol, micron, eco, spectrum, geo
Radio Control Receiver 505, 514, 707, 716, 717, 722, 735, 770, 808

correspond to the following EC guidelines

98/37/EG Directives for machinery
..... (altered by 91/263/EWG, 92/31/EWG, 93/68/EWG)
73/23/EWG Directives for low voltages (altered by 93/68/EWG)
1999/5/EG Radio and Telecommunications Terminal Equipment Act
..... (FTEG)

In particular, the tests executed were based on the following harmonized standards

EN 300 220 EMC - emission
EN 300 683 EMC – immunity
EN 954-1:1996 Safety of machinery;
..... Safety relevant parts of controls
EN 60529 Degree of protection provided by enclosure (IP)
IEC 68 Mechanical strength
prEN 50178 Climatic tests
DIN V VDE 0801 appendix 1 ... Principles for computers in safety-related systems

and on the following national technical standards :

ZH 1/547:1976 Directives for radio controls of cranes
ZH 1/295:1995 Safety regulations for wireless control facilities

Note : **The commissioning of the machine on which this part of the machine was installed is prohibited until it has been established that the machine corresponds to the 98/37/EG Directives.**

Authorized by :

Name, first name: Brendel, Wolfgang

Position in the company : General Manager

Location and date : Crailsheim, November 23, 2001

Authentic signature :

