

FCC Radio Test Report

FCC ID: TE7WA855REV4

This report concerns (check one): Original Grant Class I Change Class II Change

Project No. : 1803C219
Equipment : 300Mbps Wi-Fi Range Extender
Test Model : TL-WA855RE
Series Model : N/A
Applicant : TP-Link Technologies Co., Ltd.
Address : Building 24(floors1,3,4,5) and 28(floors1-4) Central Science and Technology Park, Shennan Rd, Nanshan, Shenzhen, China

Date of Receipt : Mar. 23, 2018
Date of Test : Mar. 26, 2018 ~ Apr. 20, 2018
Issued Date : Jun. 06, 2018
Tested by : BTL Inc.

Testing Engineer : Chay Cai
(Chay Cai)

Technical Manager : Shawn Xiao
(Shawn Xiao)

Authorized Signatory : Steven Lu
(Steven Lu)

B T L I N C .

No.3, Jinshagang 1st Road, Shixia, Dalang Town, Dongguan, Guangdong, China.

TEL: +86-769-8318-3000 FAX: +86-769-8319-6000



Declaration

BTL represents to the client that testing is done in accordance with standard procedures as applicable and that test instruments used has been calibrated with standards traceable to international standard(s) and/or national standard(s).

BTL's reports apply only to the specific samples tested under conditions. It is manufacture's responsibility to ensure that additional production units of this model are manufactured with the identical electrical and mechanical components. **BTL** shall have no liability for any declarations, inferences or generalizations drawn by the client or others from **BTL** issued reports.

BTL's report must not be used by the client to claim product certification, approval, or endorsement by NVLAP, NIST, or any agency of the Federal Government.

This report is the confidential property of the client. As a mutual protection to the clients, the public and **BTL-self**, extracts from the test report shall not be reproduced except in full with **BTL's** authorized written approval.

BTL's laboratory quality assurance procedures are in compliance with the **ISO Guide 17025** requirements, and accredited by the conformity assessment authorities listed in this test report.

Limitation

For the use of the authority's logo is limited unless the Test Standard(s)/Scope(s)/Item(s) mentioned in this test report is (are) included in the conformity assessment authorities acceptance respective.

Table of Contents	Page
1 . CERTIFICATION	6
2 . SUMMARY OF TEST RESULTS	7
2.1 TEST FACILITY	8
2.2 MEASUREMENT UNCERTAINTY	8
3 . GENERAL INFORMATION	9
3.1 GENERAL DESCRIPTION OF EUT	9
3.2 DESCRIPTION OF TEST MODES	11
3.3 TABLE OF PARAMETERS OF TEXT SOFTWARE SETTING	13
3.4 BLOCK DIAGRAM SHOWING THE CONFIGURATION OF SYSTEM TESTED	14
3.5 DESCRIPTION OF SUPPORT UNITS	14
4 . EMC EMISSION TEST	15
4.1 CONDUCTED EMISSION MEASUREMENT	15
4.1.1 POWER LINE CONDUCTED EMISSION LIMITS	15
4.1.2 TEST PROCEDURE	15
4.1.3 DEVIATION FROM TEST STANDARD	15
4.1.4 TEST SETUP	16
4.1.5 EUT OPERATING CONDITIONS	16
4.1.6 EUT TEST CONDITIONS	16
4.1.7 TEST RESULTS	16
4.2 RADIATED EMISSION MEASUREMENT	17
4.2.1 RADIATED EMISSION LIMITS	17
4.2.2 TEST PROCEDURE	18
4.2.3 DEVIATION FROM TEST STANDARD	18
4.2.4 TEST SETUP	19
4.2.5 EUT OPERATING CONDITIONS	20
4.2.6 EUT TEST CONDITIONS	20
4.2.7 TEST RESULTS (9KHZ TO 30MHZ)	20
4.2.8 TEST RESULTS (30MHZ TO 1000MHZ)	20
4.2.9 TEST RESULTS (ABOVE 1000MHZ)	20
5 . BANDWIDTH TEST	21
5.1 APPLIED PROCEDURES	21
5.1.1 TEST PROCEDURE	21
5.1.2 DEVIATION FROM STANDARD	21
5.1.3 TEST SETUP	21
5.1.4 EUT OPERATION CONDITIONS	21
5.1.5 EUT TEST CONDITIONS	21
5.1.6 TEST RESULTS	21
6 . MAXIMUM PEAK CONDUCTED AVG POWER TEST	22

Table of Contents	Page
6.1 APPLIED PROCEDURES / LIMIT	22
6.1.1 TEST PROCEDURE	22
6.1.2 DEVIATION FROM STANDARD	22
6.1.3 TEST SETUP	22
6.1.4 EUT OPERATION CONDITIONS	22
6.1.5 EUT TEST CONDITIONS	22
6.1.6 TEST RESULTS	22
7 . ANTENNA CONDUCTED SPURIOUS EMISSION	23
7.1 APPLIED PROCEDURES / LIMIT	23
7.1.1 TEST PROCEDURE	23
7.1.2 DEVIATION FROM STANDARD	23
7.1.3 TEST SETUP	23
7.1.4 EUT OPERATION CONDITIONS	23
7.1.5 EUT TEST CONDITIONS	23
7.1.6 TEST RESULTS	23
8 . POWER SPECTRAL DENSITY TEST	24
8.1 APPLIED PROCEDURES / LIMIT	24
8.1.1 TEST PROCEDURE	24
8.1.2 DEVIATION FROM STANDARD	24
8.1.3 TEST SETUP	24
8.1.4 EUT OPERATION CONDITIONS	24
8.1.5 EUT TEST CONDITIONS	24
8.1.6 TEST RESULTS	24
9 . MEASUREMENT INSTRUMENTS LIST	25
10 . EUT TEST PHOTO	27
APPENDIX A - CONDUCTED EMISSION	31
APPENDIX B - RADIATED EMISSION (9KHZ TO 30MHZ)	34
APPENDIX C - RADIATED EMISSION (30MHZ TO 1000MHZ)	39
APPENDIX D - RADIATED EMISSION (ABOVE 1000MHZ)	46
APPENDIX E - BANDWIDTH	127
APPENDIX F - MAXIMUM PEAK CONDUCTED AVG POWER	136
APPENDIX G - ANTENNA CONDUCTED SPURIOUS EMISSION	141
APPENDIX H - POWER SPECTRAL DENSITY	190

REPORT ISSUED HISTORY

Issued No.	Description	Issued Date
BTL-FCCP-1-1803C219	Original Issue.	Jun. 06, 2018

1. CERTIFICATION

Equipment : 300Mbps Wi-Fi Range Extender
Brand Name : tp-link
Test Model : TL-WA855RE
Series Model : N/A
Applicant : TP-Link Technologies Co., Ltd.
Manufacturer : TP-Link Technologies Co., Ltd.
Address : Building 24(floors1,3,4,5) and 28(floors1-4) Central Science and Technology Park, Shennan Rd, Nanshan, Shenzhen, China
Factory : TP-Link Technologies Co., Ltd.
Address : Building 24(floors1,3,4,5) and 28(floors1-4) Central Science and Technology Park, Shennan Rd, Nanshan, Shenzhen, China
Date of Test : Mar. 26, 2018 ~ Apr. 20, 2018
Test Sample : Engineering Sample:
Conducted:NO.:D180302439, Radiated:NO.:D180302437
Standard(s) : FCC Part15, Subpart C:(15.247) / ANSI C63.10-2013

The above equipment has been tested and found compliance with the requirement of the relative standards by BTL Inc.

The test data, data evaluation, and equipment configuration contained in our test report (Ref No. BTL-FCCP-1-1803C219) were obtained utilizing the test procedures, test instruments, test sites that has been accredited by the Authority of NVLAP according to the ISO-17025 quality assessment standard and technical standard(s).

2. SUMMARY OF TEST RESULTS

Test procedures according to the technical standard(s):

Applied Standard(s): FCC Part15 (15.247) , Subpart C			
Standard(s) Section	Test Item	Judgment	Remark
15.207	Conducted Emission	PASS	
15.247(d)	Antenna conducted Spurious Emission	PASS	
15.247(a)(2)	6dB Bandwidth	PASS	
15.247(b)(3)	AVG Output Power	PASS	
15.247(e)	Power Spectral Density	PASS	
15.203	Antenna Requirement	PASS	
15.247(d)/ 15.205/ 15.209	Transmitter Radiated Emissions	PASS	

NOTE:

(1) "N/A" denotes test is not applicable in this test report.

2.1 TEST FACILITY

The test facilities used to collect the test data in this report is at the location of No.3,Jinshagang 1st Road, Shixia, Dalang Town, Dongguan, Guangdong, China.

BTL's test firm number for FCC: 854385

BTL's designation number for FCC: CN5020

2.2 MEASUREMENT UNCERTAINTY

The measurement uncertainty figures shall be calculated according the methods described in the ETSI TR 100 028 and shall correspond to an expansion factor (coverage factor) $k=1.96$ or $k=2$ (which provide confidence levels of respectively 90% and 95.45% in the case where the distributions characterizing the actual measurement uncertainties are normal (Gaussian)). Measurement Uncertainty for a Level of Confidence of 95 %, $U=2xUc(y)$.

The BTL measurement uncertainty as below table:

A. Conducted Measurement:

Test Site	Method	Measurement Frequency Range	U, (dB)
DG-C02	CISPR	150 KHz ~ 30MHz	2.32

B. Radiated Measurement:

Test Site	Method	Measurement Frequency Range	Ant. H / V	U, (dB)
DG-CB03	CISPR	9KHz~30MHz	V	3.79
		9KHz~30MHz	H	3.57
		30MHz ~ 200MHz	V	3.82
		30MHz ~ 200MHz	H	3.78
		200MHz ~ 1,000MHz	V	4.10
		200MHz ~ 1,000MHz	H	4.06
		1GHz~18GHz	V	3.12
		1GHz~18GHz	H	3.68
		18GHz~40GHz	V	4.15
		18GHz~40GHz	H	4.14

Note: Unless specifically mentioned, the uncertainty of measurement has not been taken into account to declare the compliance or non-compliance to the specification.

3. GENERAL INFORMATION

3.1 GENERAL DESCRIPTION OF EUT

Equipment	300Mbps Wi-Fi Range Extender	
Brand Name	tp-link	
Test Model	TL-WA855RE	
Series Model	N/A	
Model Difference	N/A	
Product Description	Operation Frequency	2412~2462 MHz
	Modulation Technology	802.11b:DSSS 802.11g:OFDM 802.11n:OFDM
	Bit Rate of Transmitter	802.11b: 11/5.5/2/1 Mbps 802.11g: 54/48/36/24/18/12/9/6 Mbps 802.11n up to 300 Mbps
	AVG Output Power (Max.)	802.11b: 22.03dBm 802.11g: 23.58dBm 802.11n(20MHz): 23.48dBm 802.11n(40MHz): 20dBm
Power Source	AC Mains.	
Power Rating	AC 100-240V 50/60Hz	

Note:

1. For a more detailed features description, please refer to the manufacturer's specifications or the user's manual.

2. Channel List:

CH01 - CH11 for 802.11b, 802.11g, 802.11n(20MHz) CH03 - CH09 for 802.11n(40MHz)							
Channel	Frequency (MHz)	Channel	Frequency (MHz)	Channel	Frequency (MHz)	Channel	Frequency (MHz)
01	2412	04	2427	07	2442	10	2457
02	2417	05	2432	08	2447	11	2462
03	2422	06	2437	09	2452		

3. Table for Filed Antenna

Ant.	Brand	Model Name	Antenna Type	Connector	Gain (dBi)
1	N/A	N/A	Dipole	N/A	2
2	N/A	N/A	Dipole	N/A	2

Note:

(1) The EUT incorporates a MIMO function. Physically, the EUT provides two completed two t ransmitters and two receivers (2T2R)

4.

The worst case for 2TX as follow:

Operating Mode	TX Mode	2TX
802.11b		V (ANT 1+ANT 2)
802.11g		V (ANT 1+ANT 2)
802.11n(20MHz)		V (ANT 1+ANT 2)
802.11n(40MHz)		V (ANT 1+ANT 2)

3.2 DESCRIPTION OF TEST MODES

To investigate the maximum EMI emission characteristics generated from EUT, the test system was pre-scanning tested based on the consideration of following EUT operation mode or test configuration mode which possibly have effect on EMI emission level. Each of these EUT operation mode(s) or test configuration mode(s) mentioned above was evaluated respectively.

Pretest Mode	Description
Mode 1	TX B MODE CHANNEL 01/06/11
Mode 2	TX G MODE CHANNEL 01/06/11
Mode 3	TX N-20MHZ MODE CHANNEL 01/06/11
Mode 4	TX N-40MHZ MODE CHANNEL 03/06/09
Mode 5	Normal Link

The EUT system operated these modes were found to be the worst case during the pre-scanning test as following:

For Conducted Test	
Final Test Mode	Description
Mode 5	Normal Link

For Radiated Test	
Final Test Mode	Description
Mode 1	TX B MODE CHANNEL 01/06/11
Mode 2	TX G MODE CHANNEL 01/06/11
Mode 3	TX N-20MHZ MODE CHANNEL 01/06/11
Mode 4	TX N-40MHZ MODE CHANNEL 03/06/09

For Band Edge Test	
Final Test Mode	Description
Mode 1	TX B MODE CHANNEL 01/06/11
Mode 2	TX G MODE CHANNEL 01/06/11
Mode 3	TX N-20MHZ MODE CHANNEL 01/06/11
Mode 4	TX N-40MHZ MODE CHANNEL 03/06/09

6dB Spectrum Bandwidth	
Final Test Mode	Description
Mode 1	TX B MODE CHANNEL 01/06/11
Mode 2	TX G MODE CHANNEL 01/06/11
Mode 3	TX N-20MHZ MODE CHANNEL 01/06/11
Mode 4	TX N-40MHZ MODE CHANNEL 03/06/09

Maximum Conducted AVE Power	
Final Test Mode	Description
Mode 1	TX B MODE CHANNEL 01/06/11
Mode 2	TX G MODE CHANNEL 01/06/11
Mode 3	TX N-20MHZ MODE CHANNEL 01/06/11
Mode 4	TX N-40MHZ MODE CHANNEL 03/06/09

Power Spectral Density	
Final Test Mode	Description
Mode 1	TX B MODE CHANNEL 01/06/11
Mode 2	TX G MODE CHANNEL 01/06/11
Mode 3	TX N-20MHZ MODE CHANNEL 01/06/11
Mode 4	TX N-40MHZ MODE CHANNEL 03/06/09

Note:

- (1) The measurements are performed at the high, middle, low available channels.
- (2) 802.11b mode: CCK (1Mbps)
802.11g mode: BPSK (6Mbps)
802.11n HT20 mode : BPSK (6.5Mbps)
802.11n HT40 mode : BPSK (13.5Mbps)
- (3) For radiated below 1G test, the 802.11b is found to be the worst case and recorded.
- (4) For 6dB Spectrum Bandwidth, Ant 1 is the worst case.
- (5) For Conducted Test, Radiated Test and Band Edge Test, Ant1+Ant2 is the worst case.
- (6) The EUT was programmed to be in continuously transmitting mode and the transmit duty cycle is not less than 98%.
- (7) For radiated, it was pre-tested on the positioned of each 2 axis. The worst case was found positioned on Normal-plane. Therefore only the test data of this Normal-plane was used for radiated emission measurement test.

3.3 TABLE OF PARAMETERS OF TEXT SOFTWARE SETTING

During testing, channel & power controlling software provided by the customer was used to control the operating channel as well as the AVG power level. The RF AVG power selection is for the setting of RF AVG power expected by the customer and is going to be fixed on the firmware of the final end product power parameters of WLAN

Test software version	QATool_Dbg				
	2412	2417	2437	2457	2462
Frequency (MHz)	2412	2417	2437	2457	2462
802.11b	1C	1C	1C	1C	1C
802.11g	16	1E	20	20	19
802.11n (20MHz)	16	1E	20	1E	16
Frequency (MHz)	2422	2427	2437	2447	2452
802.11n (40MHz)	12	13	19	13	11

3.4 BLOCK DIAGRAM SHOWING THE CONFIGURATION OF SYSTEM TESTED

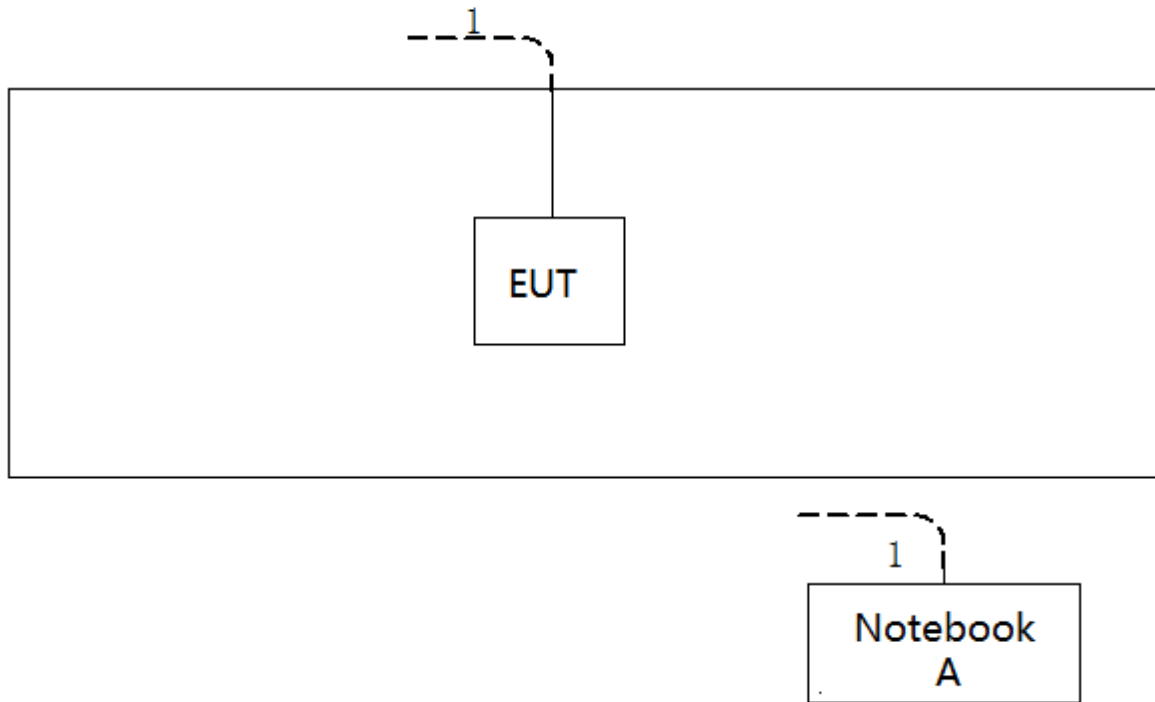

3.5 DESCRIPTION OF SUPPORT UNITS

The EUT has been tested as an independent unit together with other necessary accessories or support units. The following support units or accessories were used to form a representative test configuration during the tests.

Item	Equipment	Mfr/Brand	Model/Type No.	FCC ID	Series No.
A	Notebook	Dell	DCSM	DOC	G7K832X

Item	Shielded Type	Ferrite Core	Length	Note
1	N/A	N/A	10m	RJ45 Cable

4. EMC EMISSION TEST

4.1 CONDUCTED EMISSION MEASUREMENT

4.1.1 POWER LINE CONDUCTED EMISSION LIMITS (Frequency Range 150KHz-30MHz)

Frequency of Emission (MHz)	Conducted Limit (dB μ V)	
	Quasi-peak	Average
0.15 -0.50	66 to 56*	56 to 46*
0.50 -5.0	56	46
5.0 -30.0	60	50

Note:

- (1) The limit of " * " decreases with the logarithm of the frequency
- (2) The test result calculated as following:
 Measurement Value = Reading Level + Correct Factor
 Correct Factor = Insertion Loss + Cable Loss + Attenuator Factor(if use)
 Margin Level = Measurement Value - Limit Value

The following table is the setting of the receiver

Receiver Parameters	Setting
Attenuation	10 dB
Start Frequency	0.15 MHz
Stop Frequency	30 MHz
IF Bandwidth	9 KHz

4.1.2 TEST PROCEDURE

- a. The EUT was placed 0.8 meters from the horizontal ground plane with EUT being connected to the power mains through a line impedance stabilization network (LISN). All other support equipment powered from additional LISN(s). The LISN provide 50 Ohm/ 50uH of coupling impedance for the measuring instrument.
- b. Interconnecting cables that hang closer than 40 cm to the ground plane shall be folded back and forth in the center forming a bundle 30 to 40 cm long.
- c. I/O cables that are not connected to a peripheral shall be bundled in the center. The end of the cable may be terminated, if required, using the correct terminating impedance. The overall length shall not exceed 1 m.
- d. LISN at least 80 cm from nearest part of EUT chassis.
- e. For the actual test configuration, please refer to the related Item -EUT Test Photos.

4.1.3 DEVIATION FROM TEST STANDARD

No deviation

4.1.4 TEST SETUP

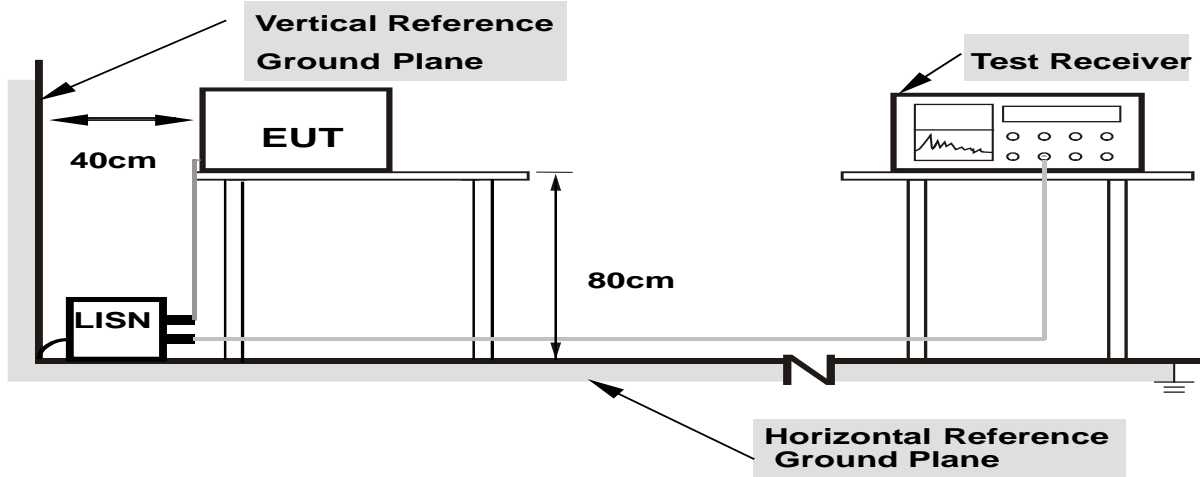

- Note:**
- 1.Support units were connected to second LISN.
 - 2.Both of LISNs (AMN) are 80 cm from EUT and at least 80 from other units and other metal planes

4.1.5 EUT OPERATING CONDITIONS

The EUT was placed on the test table and programmed in normal function.

4.1.6 EUT TEST CONDITIONS

Temperature: 25°C Relative Humidity: 55% Test Voltage: AC 120V/60Hz

4.1.7 TEST RESULTS

Please refer to the Appendix A.

4.2 RADIATED EMISSION MEASUREMENT

4.2.1 RADIATED EMISSION LIMITS

In case the emission fall within the restricted band specified on 15.205(a), then the 15.209(a) limit in the table below has to be followed.

LIMITS OF RADIATED EMISSION MEASUREMENT (9KHz-1000MHz)

Frequency (MHz)	Field Strength (microvolts/meter)	Measurement Distance (meters)
0.009~0.490	2400/F(KHz)	300
0.490~1.705	24000/F(KHz)	30
1.705~30.0	30	30
30~88	100	3
88~216	150	3
216~960	200	3
960~1000	500	3

LIMITS OF RADIATED EMISSION MEASUREMENT (Above 1000MHz)

Frequency (MHz)	(dBuV/m) (at 3 meters)	
	PEAK	AVERAGE
Above 1000	74	54

Notes:

- (1) The limit for radiated test was performed according to FCC PART 15C.
- (2) The tighter limit applies at the band edges.
- (3) Emission level (dBuV/m)=20log Emission level (uV/m).
- (4) The test result calculated as following:
 Measurement Value = Reading Level + Correct Factor
 Correct Factor = Antenna Factor + Cable Loss - Amplifier Gain(if use)
 Margin Level = Measurement Value - Limit Value

Spectrum Parameter	Setting
Attenuation	Auto
Start Frequency	1000 MHz
Stop Frequency	10th carrier harmonic
RBW / VBW (Emission in restricted band)	1MHz / 3MHz for Peak, 1MHz / 1/T for Average

Receiver Parameter	Setting
Attenuation	Auto
Start ~ Stop Frequency	9KHz~90KHz for PK/AVG detector
Start ~ Stop Frequency	90KHz~110KHz for QP detector
Start ~ Stop Frequency	110KHz~490KHz for PK/AVG detector
Start ~ Stop Frequency	490KHz~30MHz for QP detector
Start ~ Stop Frequency	30MHz~1000MHz for QP detector

4.2.2 TEST PROCEDURE

- a. The measuring distance of 3 m shall be used for measurements. The EUT was placed on the top of a rotating table 0.8 meter above the ground at a 3 meter semi-anechoic chamber. The table was rotated 360 degrees to determine the position of the highest radiation.(below 1GHz)
- b. The measuring distance of 3 m shall be used for measurements. The EUT was placed on the top of a rotating table 1.5 meter above the ground at a 3 meter semi-anechoic chamber. The table was rotated 360 degrees to determine the position of the highest radiation.(above 1GHz)
- c. The height of the equipment or of the substitution antenna shall be 0.8m or 1.5m; the height of the test antenna shall vary between 1 m to 4 m. Both horizontal and vertical polarizations of the antenna are set to make the measurement.
- d. For each suspected emission, the EUT was arranged to its worst case and then the antenna was tuned to heights find the maximum reading (used Bore sight function).
- e. The receiver system was set to peak and average detect function and specified bandwidth with maximum hold mode when the test frequency is above 1GHz.
- f. The initial step in collecting radiated emission data is a receiver peak detector mode pre-scanning the measurement frequency range. Significant peaks are then marked and then Quasi Peak detector mode re-measured.
- g. All readings are Peak unless otherwise stated QP in column of Note. Peak denotes that the Peak reading compliance with the QP Limits and then QP Mode measurement didn't perform. (below 1GHz)
- h. All readings are Peak Mode value unless otherwise stated AVG in column of Note. If the Peak Mode Measured value compliance with the Peak Limits and lower than AVG Limits, the EUT shall be deemed to meet both Peak & AVG Limits and then only Peak Mode was measured, but AVG Mode didn't perform. (above 1GHz)
- i. For the actual test configuration, please refer to the related Item -EUT Test Photos.

4.2.3 DEVIATION FROM TEST STANDARD

No deviation

4.2.4 TEST SETUP

(A) Radiated Emission Test Set-Up Frequency Below 1 GHz

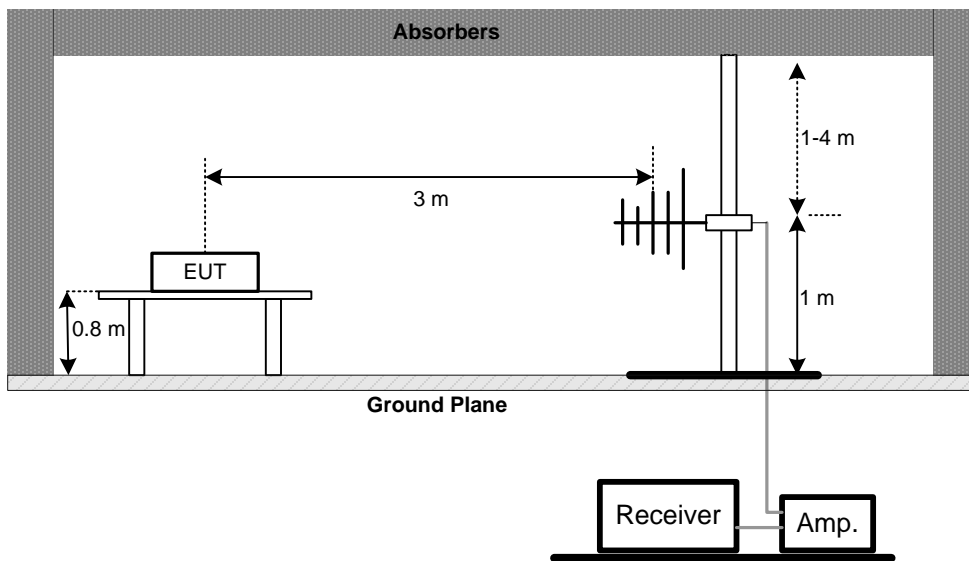

(B) Radiated Emission Test Set-Up Frequency Above 1 GHz

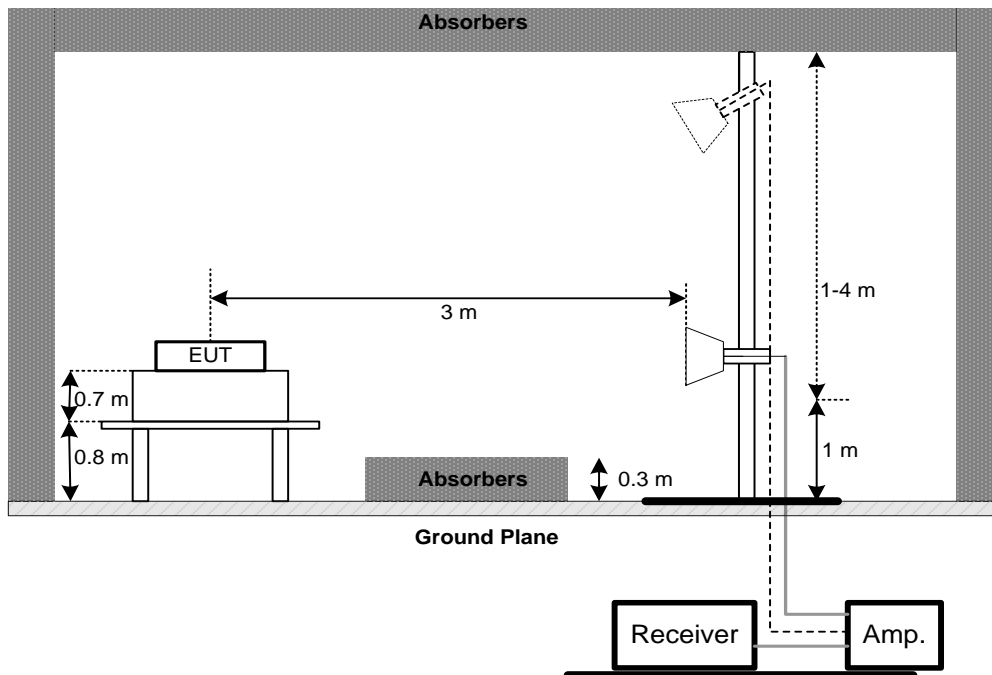

(C) For Radiated Emissions Below 30MHz

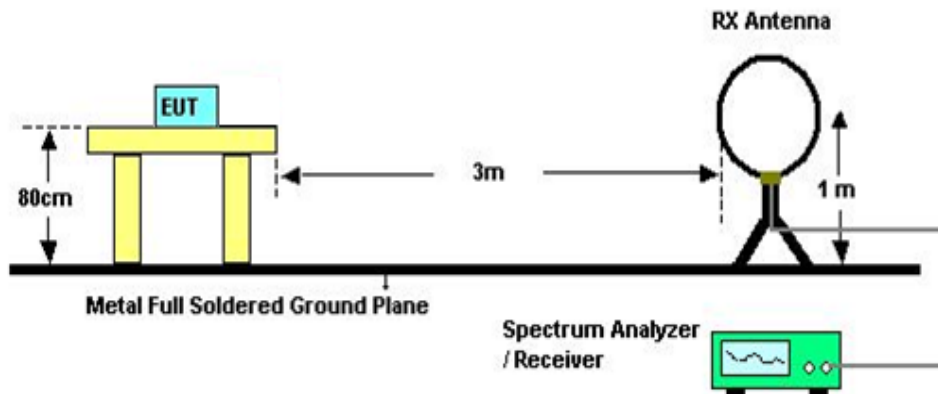

4.2.5 EUT OPERATING CONDITIONS

The EUT was programmed to be in continuously transmitting mode.

4.2.6 EUT TEST CONDITIONS

Temperature: 25°C Relative Humidity: 55% Test Voltage: AC 120V/60Hz

4.2.7 TEST RESULTS (9KHZ TO 30MHZ)

Please refer to the Appendix B

Remark:

- (1) The amplitude of spurious emissions which are attenuated by more than 20 dB below the permissible value has no need to be reported.
- (2) Distance extrapolation factor = $40 \log (\text{specific distance} / \text{test distance})$ (dB).
- (3) Limit line = specific limits (dBuV) + distance extrapolation factor.

4.2.8 TEST RESULTS (30MHZ TO 1000MHZ)

Please refer to the Appendix C.

4.2.9 TEST RESULTS (ABOVE 1000MHZ)

Please refer to the Appendix D.

Remark:

- (1) No limit: This is fundamental signal, the judgment is not applicable.
For fundamental signal judgment was referred to Peak output test.

5. BANDWIDTH TEST

5.1 APPLIED PROCEDURES

FCC Part15 (15.247) , Subpart C			
Section	Test Item	Frequency Range (MHz)	Result
15.247(a)(2)	Bandwidth	2400-2483.5	PASS

5.1.1 TEST PROCEDURE

- a. The EUT was directly connected to the spectrum analyzer and antenna output port as show in the block diagram below,
- b. Spectrum Setting: RBW= 100KHz, VBW=300KHz, Sweep time = 2.5 ms.

5.1.2 DEVIATION FROM STANDARD

No deviation.

5.1.3 TEST SETUP



5.1.4 EUT OPERATION CONDITIONS

The EUT was programmed to be in continuously transmitting mode.

5.1.5 EUT TEST CONDITIONS

Temperature: 25°C Relative Humidity: 55% Test Voltage: AC 120V/60Hz

5.1.6 TEST RESULTS

Please refer to the Appendix E.

6. MAXIMUM PEAK CONDUCTED AVG POWER TEST

6.1 APPLIED PROCEDURES / LIMIT

FCC Part15 (15.247) , Subpart C				
Section	Test Item	Limit	Frequency Range (MHz)	Result
15.247(b)(3)	Maximum AVG Power	1 Watt or 30dBm	2400-2483.5	PASS

6.1.1 TEST PROCEDURE

- a. The EUT was directly connected to the power meter and antenna output port as show in the block diagram below,
- b. The maximum peak conducted AVG power was performed in accordance with method 9.1.2 of FCC KDB 558074 D01 v04 DTS Meas Guidance and FCC KDB 662911 D01 v02r01 Multiple Transmitter Output.

6.1.2 DEVIATION FROM STANDARD

No deviation.

6.1.3 TEST SETUP

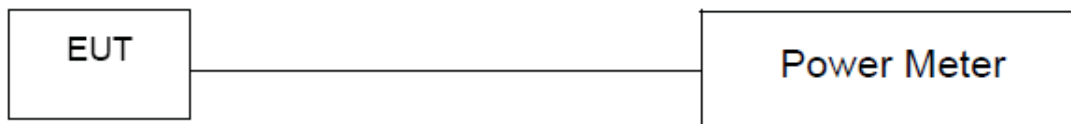

6.1.4 EUT OPERATION CONDITIONS

The EUT was programmed to be in continuously transmitting mode.

6.1.5 EUT TEST CONDITIONS

Temperature: 25°C Relative Humidity: 55% Test Voltage: AC 120V/60Hz

6.1.6 TEST RESULTS

Please refer to the Appendix F.

7. ANTENNA CONDUCTED SPURIOUS EMISSION

7.1 APPLIED PROCEDURES / LIMIT

In any 100 kHz bandwidth outside the frequency band in which the spread spectrum or digitally modulated device is operating, the RF power that is produced shall be at least 20 dB below that in the 100 kHz bandwidth within the band that contains the highest level of the desired power, based on either an RF conducted or a radiated measurement, provided that the transmitter demonstrates compliance with the peak conducted power limits.

7.1.1 TEST PROCEDURE

- a. The EUT was directly connected to the spectrum analyzer and antenna output port as show in the block diagram below,
- b. Spectrum Setting: RBW= 100KHz, VBW=300KHz, Sweep time = Auto.

7.1.2 DEVIATION FROM STANDARD

No deviation.

7.1.3 TEST SETUP

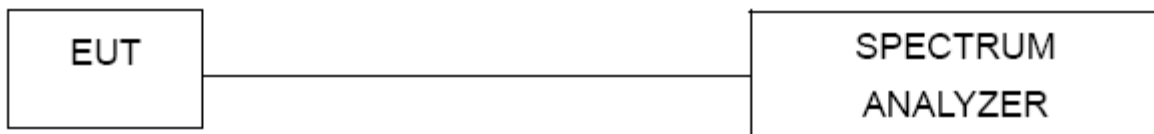

7.1.4 EUT OPERATION CONDITIONS

The EUT was programmed to be in continuously transmitting mode.

7.1.5 EUT TEST CONDITIONS

Temperature: 25°C Relative Humidity: 55% Test Voltage: AC 120V/60Hz

7.1.6 TEST RESULTS

Please refer to the Appendix G.

8. POWER SPECTRAL DENSITY TEST

8.1 APPLIED PROCEDURES / LIMIT

FCC Part15 (15.247) , Subpart C				
Section	Test Item	Limit	Frequency Range (MHz)	Result
15.247(e)	Power Spectral Density	8 dBm (in any 3KHz)	2400-2483.5	PASS

8.1.1 TEST PROCEDURE

- a. The EUT was directly connected to the spectrum analyzer and antenna output port as show in the block diagram below,
- b. Spectrum Setting: RBW=3KHz, VBW=10KHz, Sweep time = Auto.

8.1.2 DEVIATION FROM STANDARD

No deviation.

8.1.3 TEST SETUP



8.1.4 EUT OPERATION CONDITIONS

The EUT was programmed to be in continuously transmitting mode.

8.1.5 EUT TEST CONDITIONS

Temperature: 25°C Relative Humidity: 55% Test Voltage: AC 120V/60Hz

8.1.6 TEST RESULTS

Please refer to the Appendix H.

9. MEASUREMENT INSTRUMENTS LIST

Conducted Emission					
Item	Kind of Equipment	Manufacturer	Type No.	Serial No.	Calibrated until
1	EMI Test Receiver	R&S	ESCI	100382	Mar. 11, 2019
2	LISN	EMCO	3816/2	52765	Mar. 11, 2019
3	50Ω Terminator	SHX	TF2-3G-A	8122901	Mar. 11, 2019
4	TWO-LINE V-NETWORK	R&S	ENV216	101447	Mar. 11, 2019
5	Measurement Software	Farad	EZ-EMC Ver.NB-03A1-01	N/A	N/A
6	Cable	N/A	RG223	12m	Oct. 19, 2018

Radiated Emission Below 1GHz					
Item	Kind of Equipment	Manufacturer	Type No.	Serial No.	Calibrated until
1	Antenna	Schwarbeck	VULB9160	9160-3232	Mar. 11, 2019
2	Amplifier	HP	8447D	2944A09673	Oct. 19, 2018
3	Receiver	Agilent	N9038A	MY52130039	Aug. 20, 2018
4	Cable	emci	LMR-400(30MHz-1 GHz)(8m+5m)	N/A	Jun. 26, 2018
5	Controller	CT	SC100	N/A	N/A
6	Controller	MF	MF-7802	MF780208416	N/A
7	Measurement Software	Farad	EZ-EMC Ver.NB-03A1-01	N/A	N/A
8	Antenna	EM	EM-6876-1	230	Feb. 07, 2019

Radiated Emission Above 1GHz					
Item	Kind of Equipment	Manufacturer	Type No.	Serial No.	Calibrated until
1	Double Ridged Guide Antenna	ETS	3115	75789	Mar. 11, 2019
2	Broad-Band Horn Antenna	Schwarzbeck	BBHA 9170	9170319	Jun. 08, 2018
3	Amplifier	Agilent	8449B	3008A02274	Mar. 11, 2019
4	Microwave Preamplifier With Adaptor	EMC INSTRUMENT	EMC2654045	980039 & HA01	Mar. 11, 2019
5	Receiver	Agilent	N9038A	MY52130039	Aug. 20, 2018
6	Controller	CT	SC100	N/A	N/A
7	Controller	MF	MF-7802	MF780208416	N/A
8	Cable	emci	EMC104-SM-SM-1 2000(12m)	N/A	Jun. 26, 2018
9	Measurement Software	Farad	EZ-EMC Ver.NB-03A1-01	N/A	N/A

6dB Bandwidth					
Item	Kind of Equipment	Manufacturer	Type No.	Serial No.	Calibrated until
1	Spectrum Analyzer	R&S	FSP40	100185	Aug. 20, 2018

AVG Output Power					
Item	Kind of Equipment	Manufacturer	Type No.	Serial No.	Calibrated until
1	Power Meter	ANRITSU	ML2495A	1128009	Mar. 11, 2019
2	Pulse Power Sensor	ANRITSU	MA 2411B	1027500	Mar. 11, 2019

Antenna Conducted Spurious Emission					
Item	Kind of Equipment	Manufacturer	Type No.	Serial No.	Calibrated until
1	Spectrum Analyzer	R&S	FSP40	100185	Aug. 20, 2018

Power Spectral Density					
Item	Kind of Equipment	Manufacturer	Type No.	Serial No.	Calibrated until
1	Spectrum Analyzer	R&S	FSP40	100185	Aug. 20, 2018

Remark: "N/A" denotes no model name, serial no. or calibration specified.
 All calibration period of equipment list is one year.

10. EUT TEST PHOTO

Conducted Measurement Photos



Radiated Measurement Photos

9KHz to 30MHz



Radiated Measurement Photos

30MHz to 1000MHz

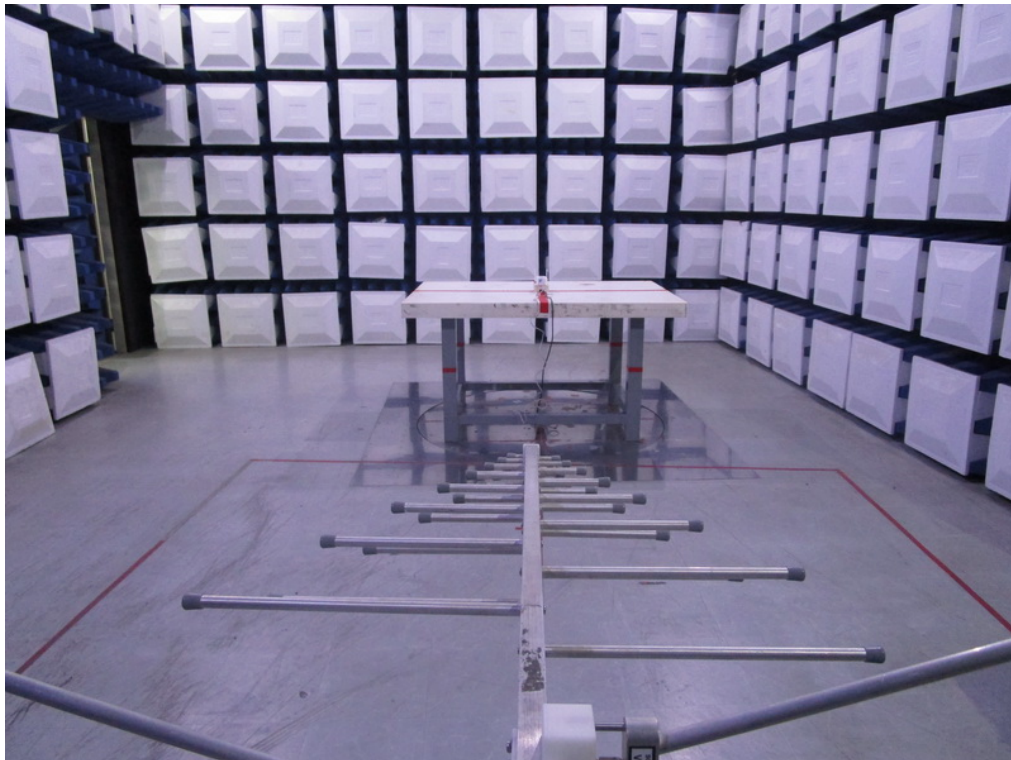
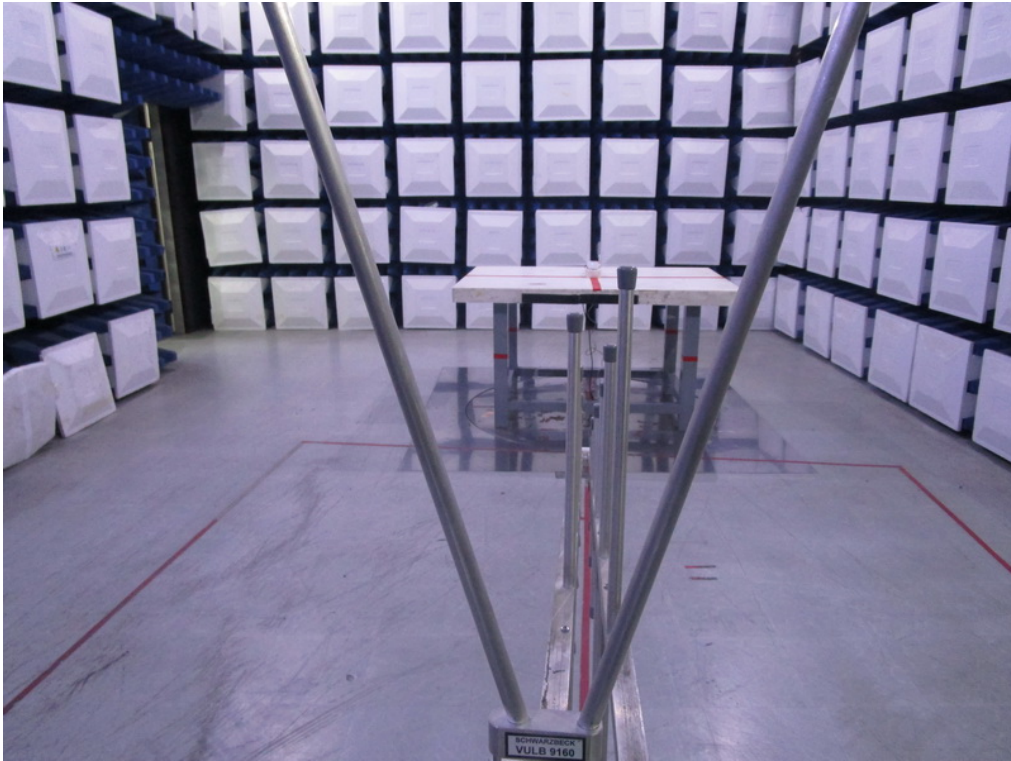

Radiated Measurement Photos

Above 1000MHz



APPENDIX A - CONDUCTED EMISSION

Test Mode : Normal Link

Line

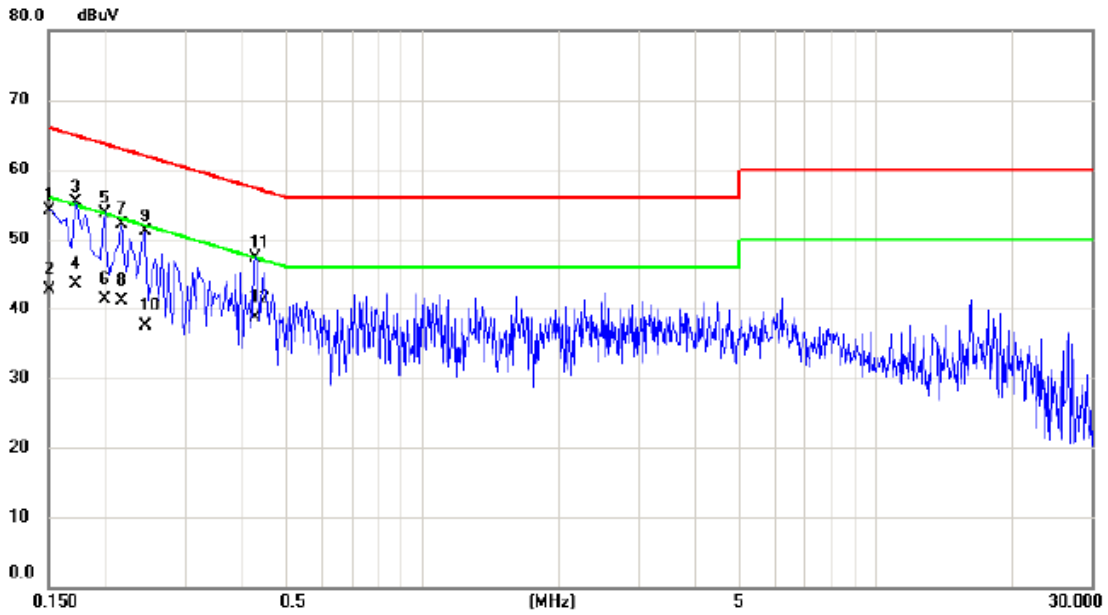

No.	Mk.	Freq. MHz	Reading Level dBuV	Correct Factor dB	Measure- ment dBuV	Limit dBuV	Margin dB	Detector	Comment
1		0.1500	44.34	9.82	54.16	66.00	-11.84	peak	
2		0.1500	32.80	9.82	42.62	56.00	-13.38	AVG	
3		0.1725	45.48	9.82	55.30	64.84	-9.54	peak	
4		0.1725	33.60	9.82	43.42	54.84	-11.42	AVG	
5		0.1995	43.98	9.82	53.80	63.63	-9.83	peak	
6		0.1995	31.50	9.82	41.32	53.63	-12.31	AVG	
7		0.2175	42.35	9.82	52.17	62.91	-10.74	peak	
8		0.2175	31.30	9.82	41.12	52.91	-11.79	AVG	
9		0.2445	41.27	9.82	51.09	61.94	-10.85	peak	
10		0.2445	27.60	9.82	37.42	51.94	-14.52	AVG	
11		0.4290	37.54	9.80	47.34	57.27	-9.93	peak	
12	*	0.4290	28.90	9.80	38.70	47.27	-8.57	AVG	

Test Mode : Normal Link

Neutral

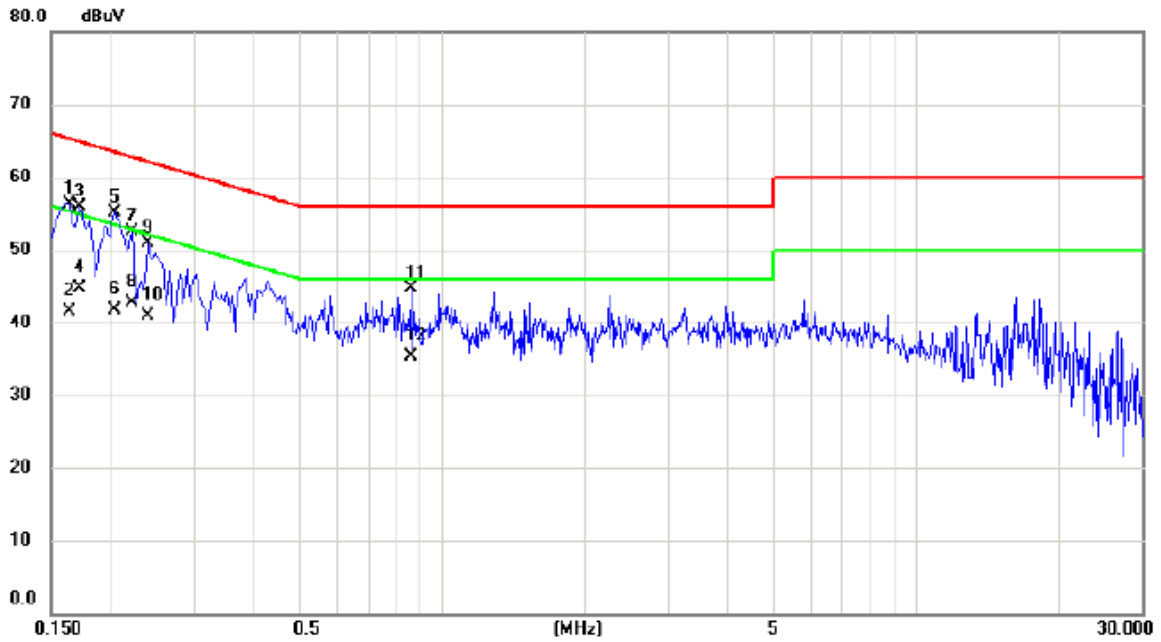

No.	Mk.	Freq. MHz	Reading Level dBuV	Correct Factor dB	Measure- ment dBuV	Limit dBuV	Margin dB	Detector	Comment
1		0.1635	46.37	9.91	56.28	65.28	-9.00	peak	
2		0.1635	31.50	9.91	41.41	55.28	-13.87	AVG	
3		0.1725	45.96	9.91	55.87	64.84	-8.97	peak	
4		0.1725	34.80	9.91	44.71	54.84	-10.13	AVG	
5	*	0.2040	45.15	9.91	55.06	63.45	-8.39	peak	
6		0.2040	31.70	9.91	41.61	53.45	-11.84	AVG	
7		0.2220	42.57	9.92	52.49	62.74	-10.25	peak	
8		0.2220	32.70	9.92	42.62	52.74	-10.12	AVG	
9		0.2400	40.93	9.92	50.85	62.10	-11.25	peak	
10		0.2400	30.90	9.92	40.82	52.10	-11.28	AVG	
11		0.8610	34.66	10.09	44.75	56.00	-11.25	peak	
12		0.8610	25.30	10.09	35.39	46.00	-10.61	AVG	

APPENDIX B - RADIATED EMISSION (9KHZ TO 30MHZ)

Test Mode: TX B MODE CHANNEL 01

Ant 0°

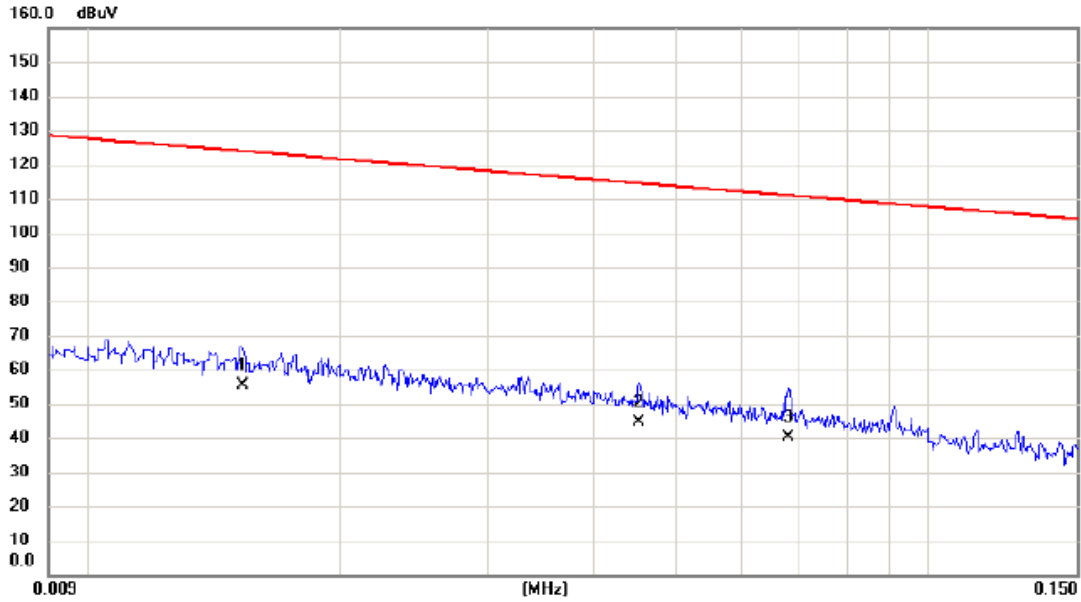

No.	Mk.	Freq. MHz	Reading Level dBuV	Correct Factor dB	Measure- ment dBuV	Limit dBuV	Margin dB	Detector	Comment
1	*	0.0153	35.30	20.23	55.53	123.91	-68.38	AVG	
2		0.0452	25.80	18.86	44.66	114.50	-69.84	AVG	
3		0.0680	21.70	18.37	40.07	110.95	-70.88	AVG	

Test Mode: TX B MODE CHANNEL 01

Ant 0°

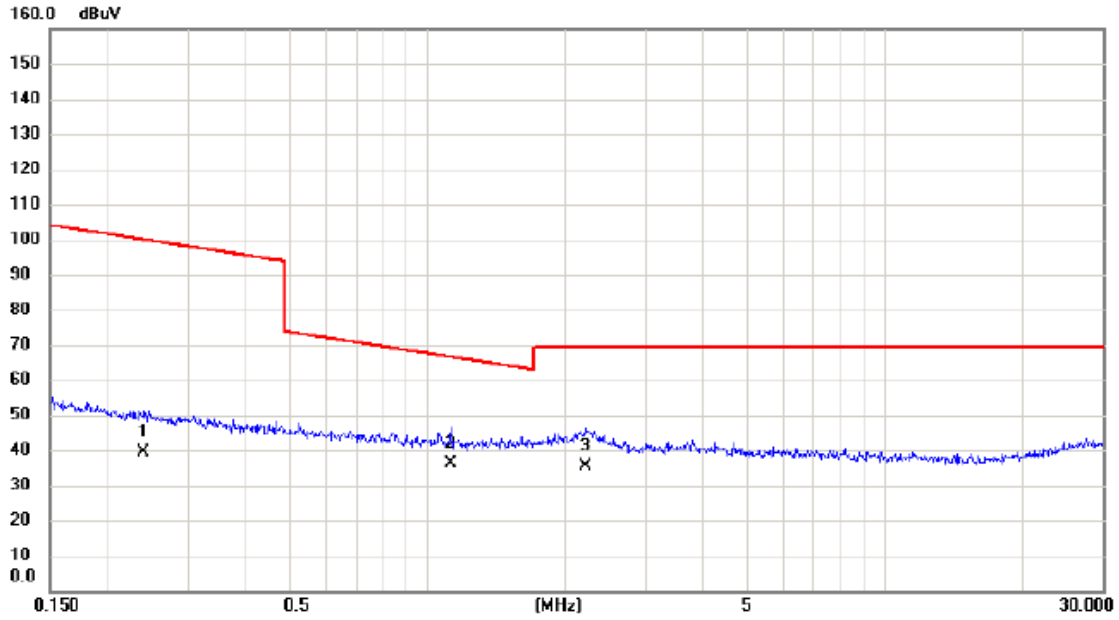

No.	Mk.	Freq. MHz	Reading Level dBuV	Correct Factor dB	Measure- ment dBuV	Limit dBuV	Margin dB	Detector	Comment
1		0.2404	22.90	16.69	39.59	99.99	-60.40	AVG	
2	*	1.1292	20.50	15.84	36.34	66.55	-30.21	QP	
3		2.2132	19.80	15.45	35.25	69.54	-34.29	QP	

Test Mode: TX B MODE CHANNEL 01

Ant 90°

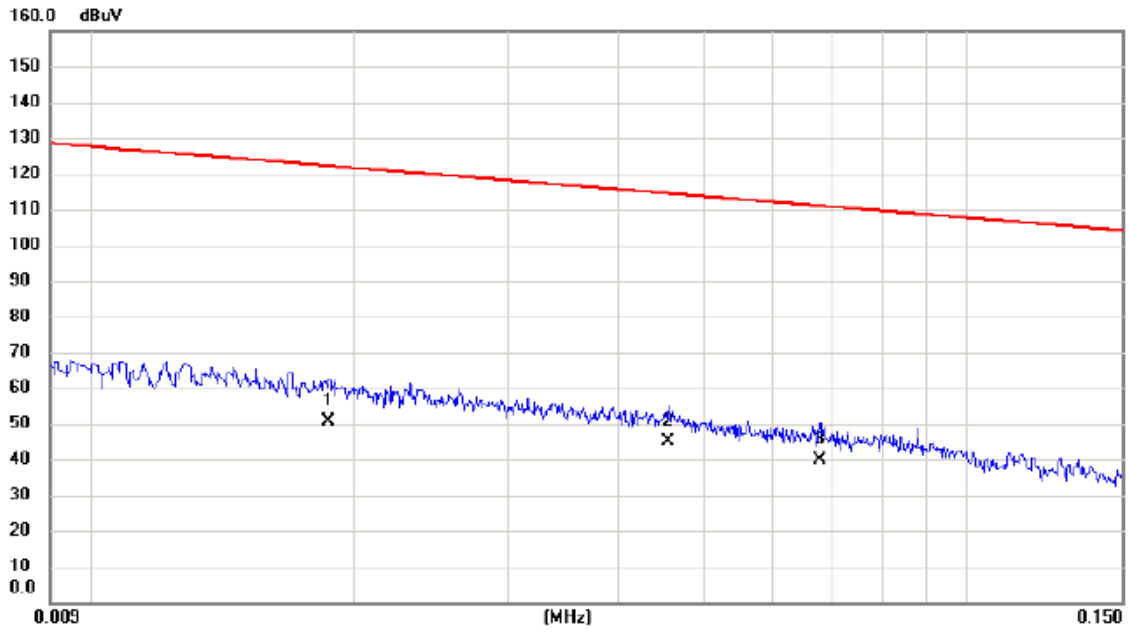

No.	Mk.	Freq. MHz	Reading Level dBuV	Correct Factor dB	Measure- ment dBuV	Limit dBuV	Margin dB	Detector	Comment
1		0.0187	30.80	19.79	50.59	122.17	-71.58	AVG	
2	*	0.0456	26.10	18.85	44.95	114.43	-69.48	AVG	
3		0.0678	21.50	18.37	39.87	110.98	-71.11	AVG	

Test Mode: TX B MODE CHANNEL 01

Ant 90°

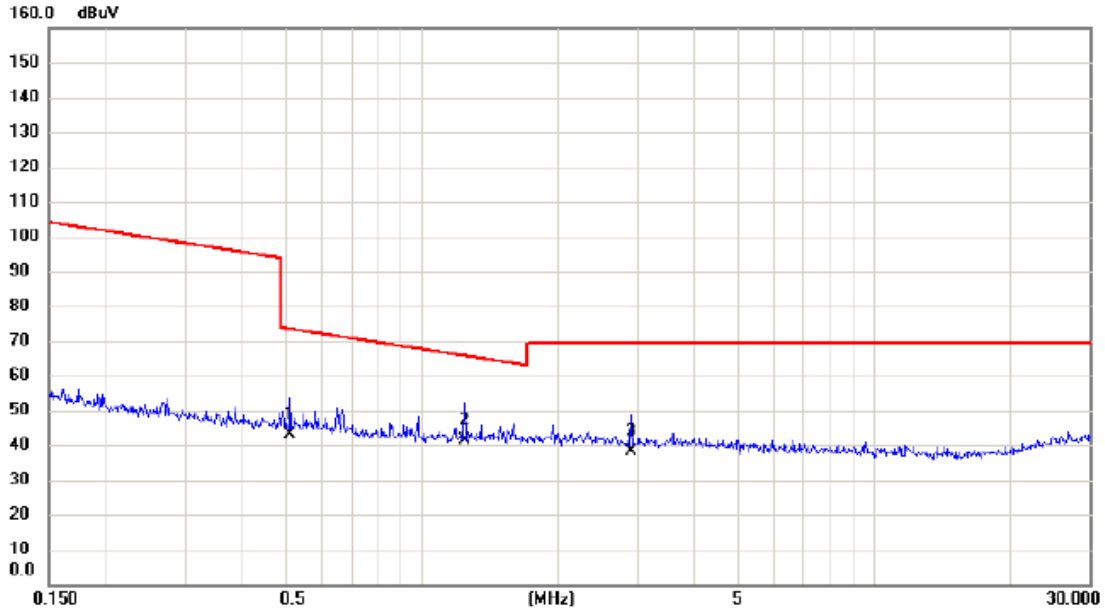

No. Mk.	Freq. MHz	Reading Level dBuV	Correct Factor dB	Measure- ment dBuV	Limit dBuV	Margin dB	Detector	Comment
1	0.5127	26.40	16.45	42.85	73.41	-30.56	QP	
2 *	1.2422	25.60	15.79	41.39	65.72	-24.33	QP	
3	2.8997	23.10	15.26	38.36	69.54	-31.18	QP	

APPENDIX C - RADIATED EMISSION (30MHZ TO 1000MHZ)

Test Mode: TX B MODE CHANNEL 01

Vertical

80 dBuV/m

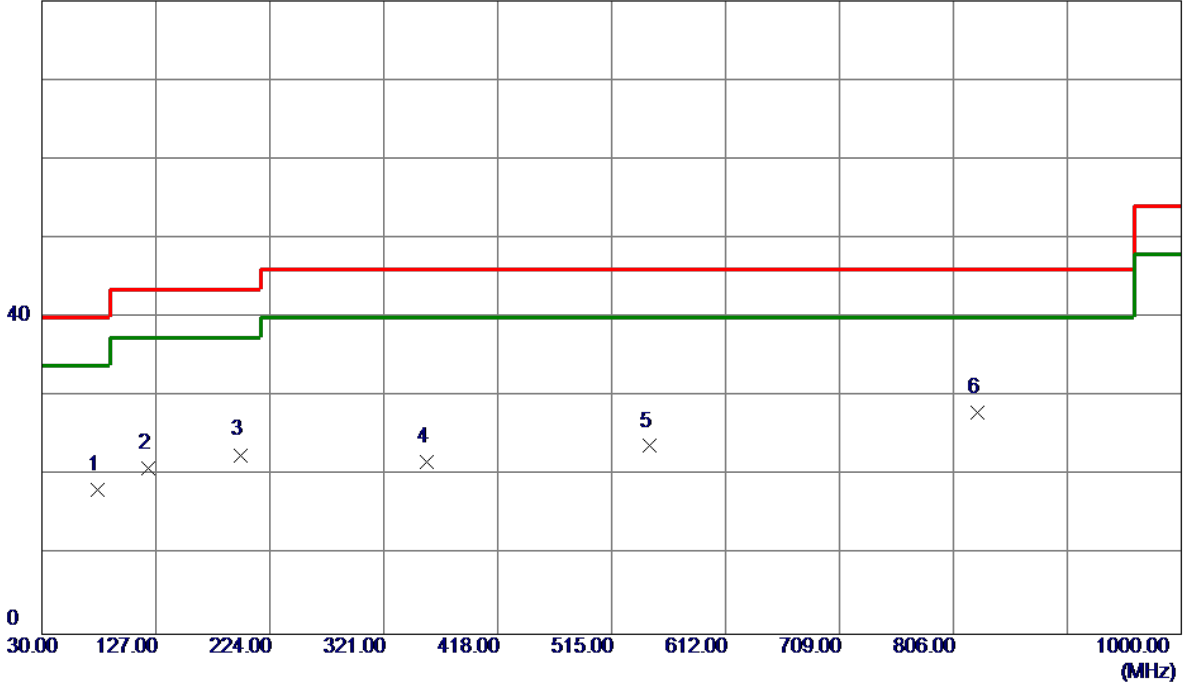

No.	Freq. MHz	Reading Level dBuV/m	Correct Factor dB	Measure ment dBuV/m	Limit dBuV/m	Margin dB	Detector	Comment
1	77.5300	37.23	-19.05	18.18	40.00	-21.82	Peak	
2	120.2100	36.33	-15.30	21.03	43.50	-22.47	Peak	
3	198.7800	38.48	-15.84	22.64	43.50	-20.86	Peak	
4	357.8599	33.36	-11.55	21.81	46.00	-24.19	Peak	
5	547.0100	30.10	-6.34	23.76	46.00	-22.24	Peak	
6 *	826.3700	30.05	-2.01	28.04	46.00	-17.96	Peak	

Test Mode: TX B MODE CHANNEL 01

Horizontal

80 dBuV/m

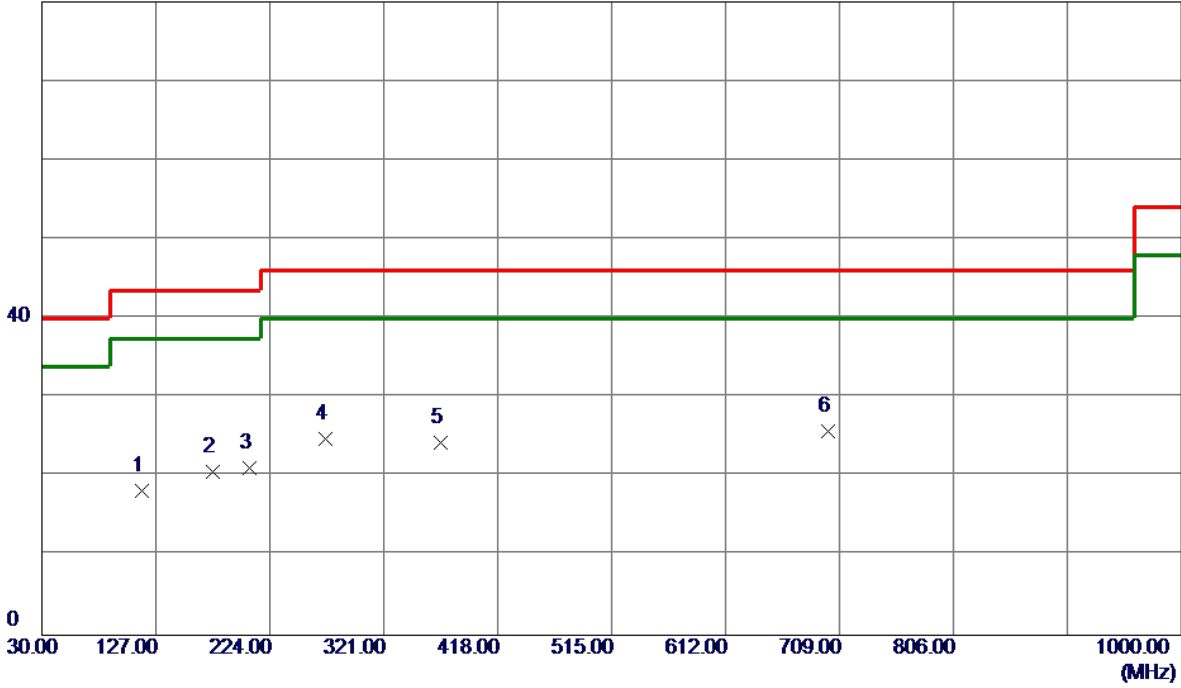

No.	Freq. MHz	Reading Level dBuV/m	Correct Factor dB	Measure ment dBuV/m	Limit dBuV/m	Margin dB	Detector	Comment
1	115.3600	34.23	-16.06	18.17	43.50	-25.33	Peak	
2	175.5000	33.37	-12.80	20.57	43.50	-22.93	Peak	
3	206.5399	37.14	-15.96	21.18	43.50	-22.32	Peak	
4	271.5300	37.96	-13.09	24.87	46.00	-21.13	Peak	
5	369.5000	35.40	-11.14	24.26	46.00	-21.74	Peak	
6 *	699.3000	29.25	-3.44	25.81	46.00	-20.19	Peak	

Test Mode: TX B MODE CHANNEL 06

Vertical

80 dBuV/m

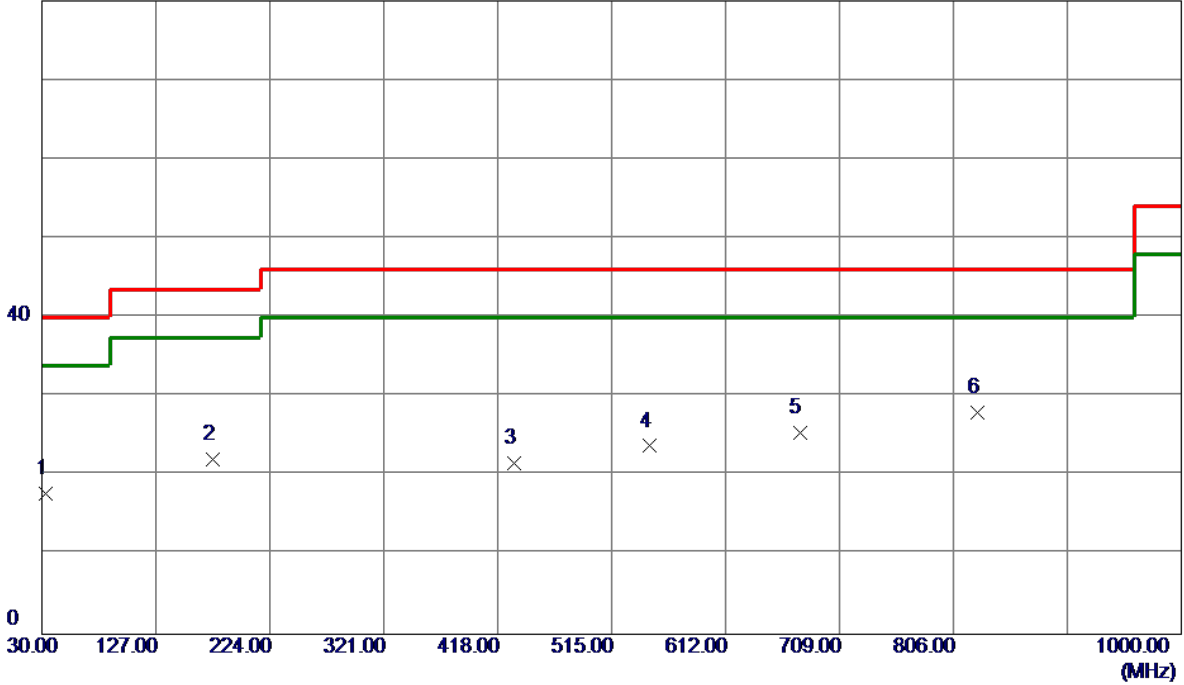

No.	Freq. MHz	Reading Level dBuV/m	Correct Factor dB	Measure ment dBuV/m	Limit dBuV/m	Margin dB	Detector	Comment
1	32.9100	33.03	-15.30	17.73	40.00	-22.27	Peak	
2	175.5000	34.94	-12.80	22.14	43.50	-21.36	Peak	
3	431.5800	30.48	-8.84	21.64	46.00	-24.36	Peak	
4	547.0100	30.10	-6.34	23.76	46.00	-22.24	Peak	
5	675.0500	30.02	-4.62	25.40	46.00	-20.60	Peak	
6 *	826.3700	30.05	-2.01	28.04	46.00	-17.96	Peak	

Test Mode: TX B MODE CHANNEL 06

Horizontal

80 dBuV/m

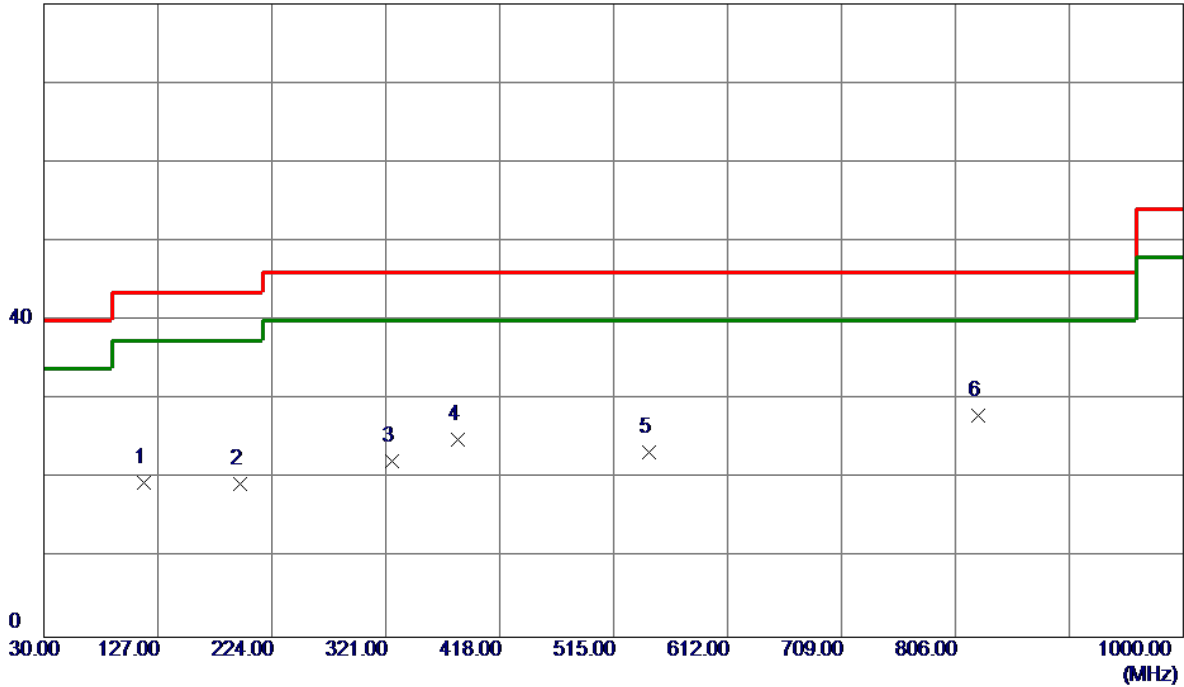

No.	Freq. MHz	Reading Level dBuV/m	Correct Factor dB	Measure ment dBuV/m	Limit dBuV/m	Margin dB	Detector	Comment
1	115.3600	35.60	-16.06	19.54	43.50	-23.96	Peak	
2	196.8400	35.05	-15.66	19.39	43.50	-24.11	Peak	
3	326.8200	33.72	-11.49	22.23	46.00	-23.77	Peak	
4	382.1099	35.74	-10.71	25.03	46.00	-20.97	Peak	
5	545.0700	29.85	-6.46	23.39	46.00	-22.61	Peak	
6 *	825.4000	30.00	-1.99	28.01	46.00	-17.99	Peak	

Test Mode: TX B MODE CHANNEL 11

Vertical

80 dBuV/m

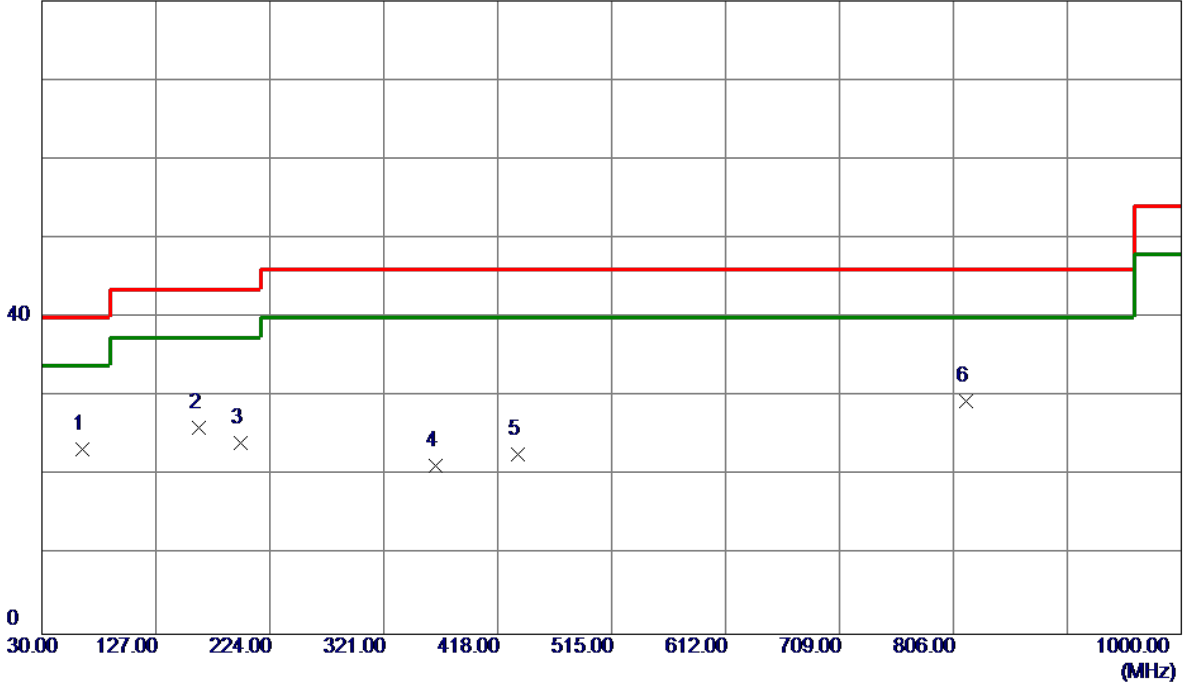

No.	Freq. MHz	Reading Level dBuV/m	Correct Factor dB	Measure ment dBuV/m	Limit dBuV/m	Margin dB	Detector	Comment
1	64.9200	40.39	-17.03	23.36	40.00	-16.64	Peak	
2	163.8600	37.62	-11.53	26.09	43.50	-17.41	Peak	
3	198.7800	40.03	-15.84	24.19	43.50	-19.31	Peak	
4	365.6200	32.63	-11.28	21.35	46.00	-24.65	Peak	
5	435.4600	31.36	-8.69	22.67	46.00	-23.33	Peak	
6 *	816.6700	31.25	-1.87	29.38	46.00	-16.62	Peak	

Test Mode: TX B MODE CHANNEL 11

Horizontal

80 dBuV/m

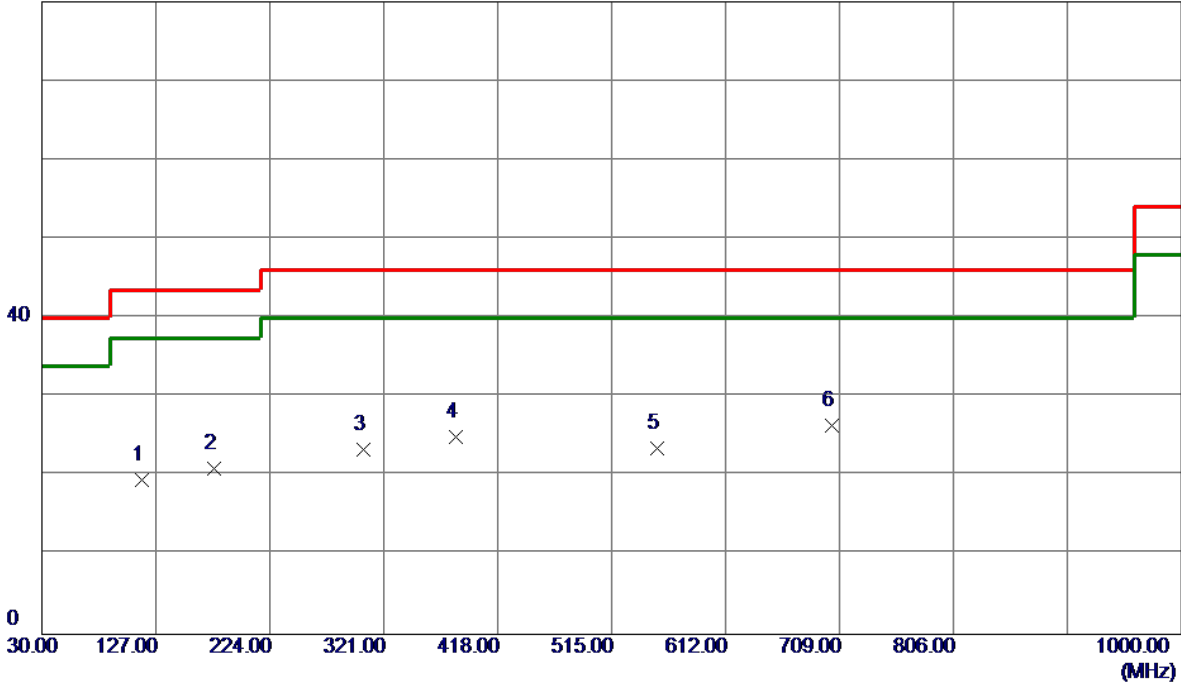

No.	Freq. MHz	Reading Level dBuV/m	Correct Factor dB	Measure ment dBuV/m	Limit dBuV/m	Margin dB	Detector	Comment
1	115.3600	35.60	-16.06	19.54	43.50	-23.96	Peak	
2	176.4700	33.90	-12.95	20.95	43.50	-22.55	Peak	
3	303.5400	34.52	-11.17	23.35	46.00	-22.65	Peak	
4	382.1099	35.74	-10.71	25.03	46.00	-20.97	Peak	
5	553.8000	29.76	-6.22	23.54	46.00	-22.46	Peak	
6 *	702.2100	29.91	-3.46	26.45	46.00	-19.55	Peak	

APPENDIX D - RADIATED EMISSION (ABOVE 1000MHZ)

Orthogonal Axis :	X
Test Mode :	TX B MODE 2412MHz

Vertical

130 dBuV/m

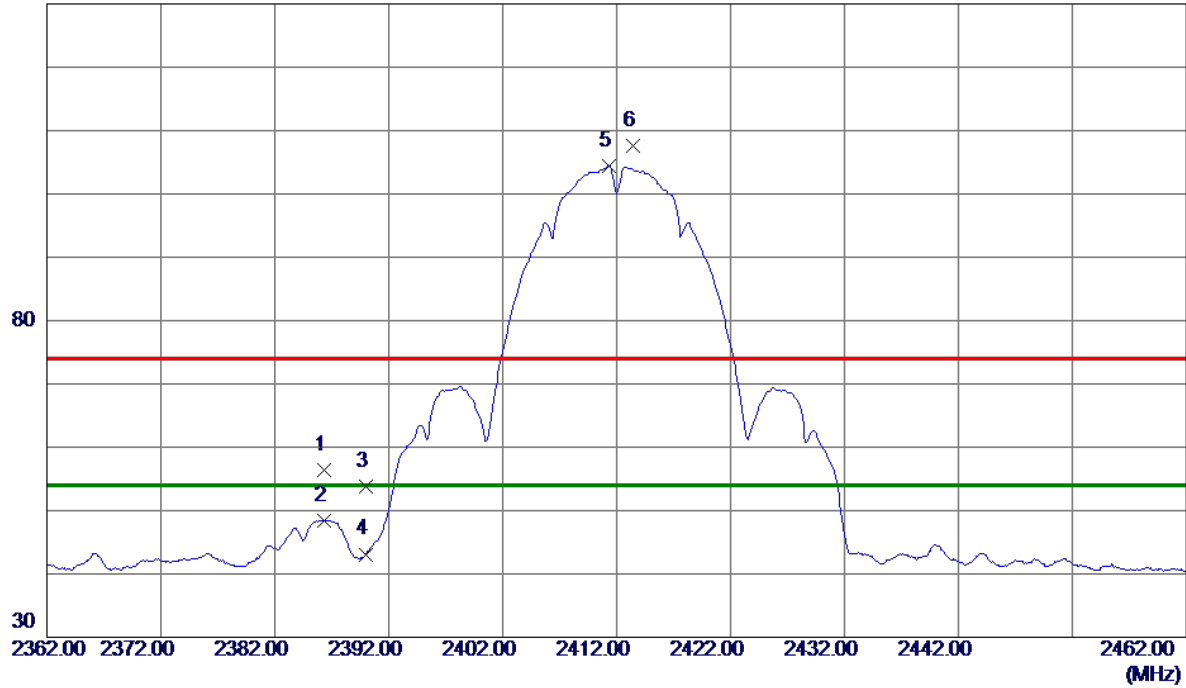

No.	Freq. MHz	Reading Level dBuV/m	Correct Factor dB	Measure ment dBuV/m	Limit dBuV/m	Margin dB	Detector	Comment
1	2386.3000	46.42	10.02	56.44	74.00	-17.56	Peak	
2	2386.3000	38.42	10.02	48.44	54.00	-5.56	AVG	
3	2390.0000	43.83	10.03	53.86	74.00	-20.14	Peak	
4	2390.0000	33.07	10.03	43.10	54.00	-10.90	AVG	
5 *	2411.3000	94.30	10.09	104.39	54.00	50.39	AVG	No Limit
6	2413.4000	97.49	10.10	107.59	74.00	33.59	Peak	No Limit

Orthogonal Axis :	X
Test Mode :	TX B MODE 2412MHz

Vertical

80 dBuV/m

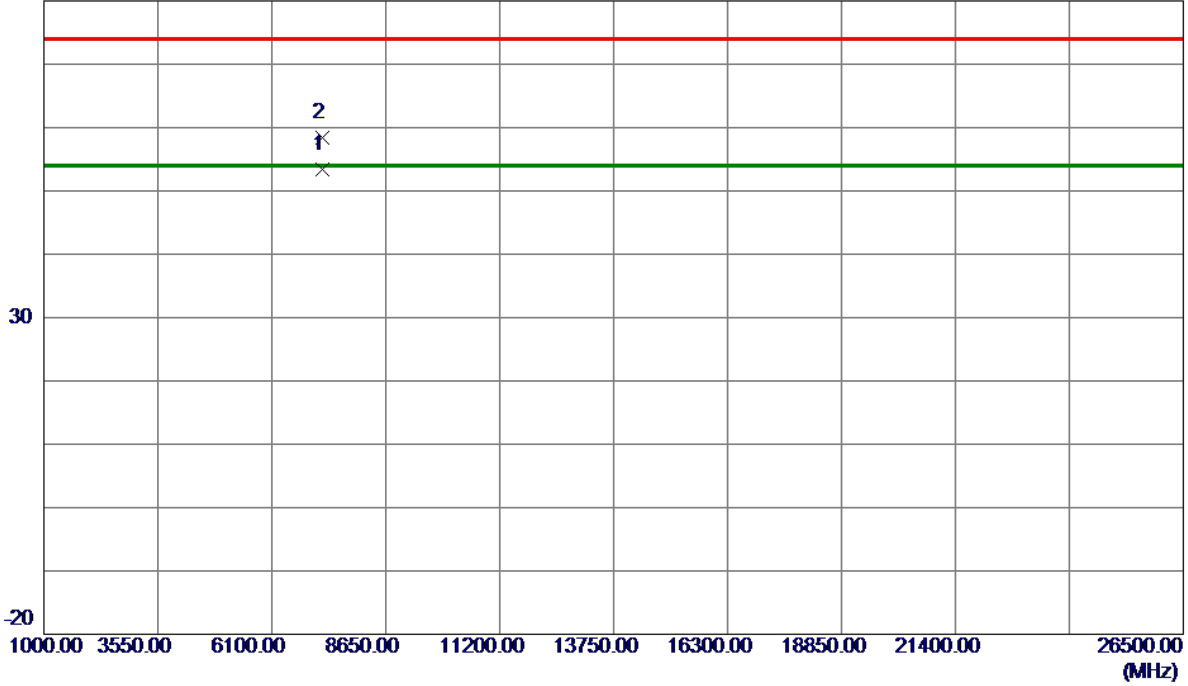

No.	Freq. MHz	Reading Level dBuV/m	Correct Factor dB	Measure ment dBuV/m	Limit dBuV/m	Margin dB	Detector	Comment
1 *	7236.8000	42.70	10.73	53.43	54.00	-0.57	AVG	
2	7237.2000	47.63	10.73	58.36	74.00	-15.64	Peak	

Orthogonal Axis :	X
Test Mode :	TX B MODE 2412MHz

Horizontal

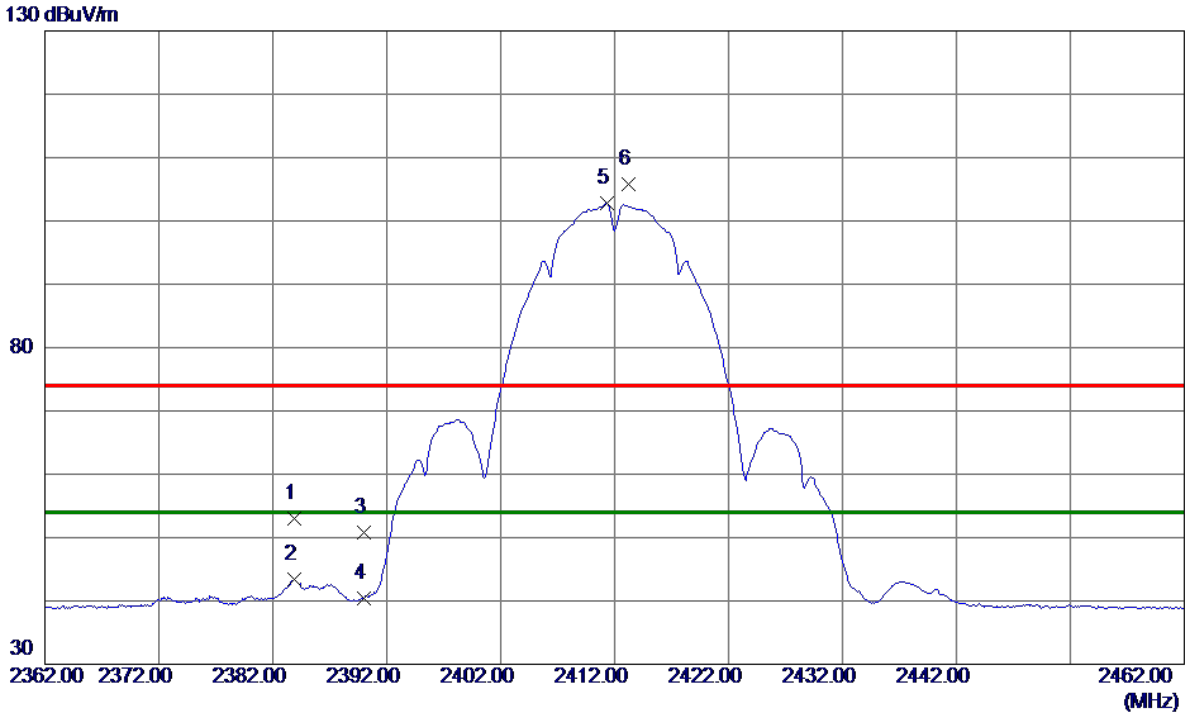

No.	Freq. MHz	Reading Level dBuV/m	Correct Factor dB	Measure ment dBuV/m	Limit dBuV/m	Margin dB	Detector	Comment
1	2383.9000	43.05	10.01	53.06	74.00	-20.94	Peak	
2	2383.9000	33.38	10.01	43.39	54.00	-10.61	AVG	
3	2390.0000	40.80	10.03	50.83	74.00	-23.17	Peak	
4	2390.0000	30.41	10.03	40.44	54.00	-13.56	AVG	
5 *	2411.3000	92.63	10.09	102.72	54.00	48.72	AVG	No Limit
6	2413.2000	95.79	10.10	105.89	74.00	31.89	Peak	No Limit

Orthogonal Axis :	X
Test Mode :	TX B MODE 2412MHz

Horizontal

80 dBuV/m



No.	Freq. MHz	Reading Level dBuV/m	Correct Factor dB	Measure ment dBuV/m	Limit dBuV/m	Margin dB	Detector	Comment
1	7234.8200	44.83	10.73	55.56	74.00	-18.44	Peak	
2 *	7235.0800	39.56	10.73	50.29	54.00	-3.71	AVG	

Orthogonal Axis :	X
Test Mode :	TX B MODE 2417MHz

Vertical

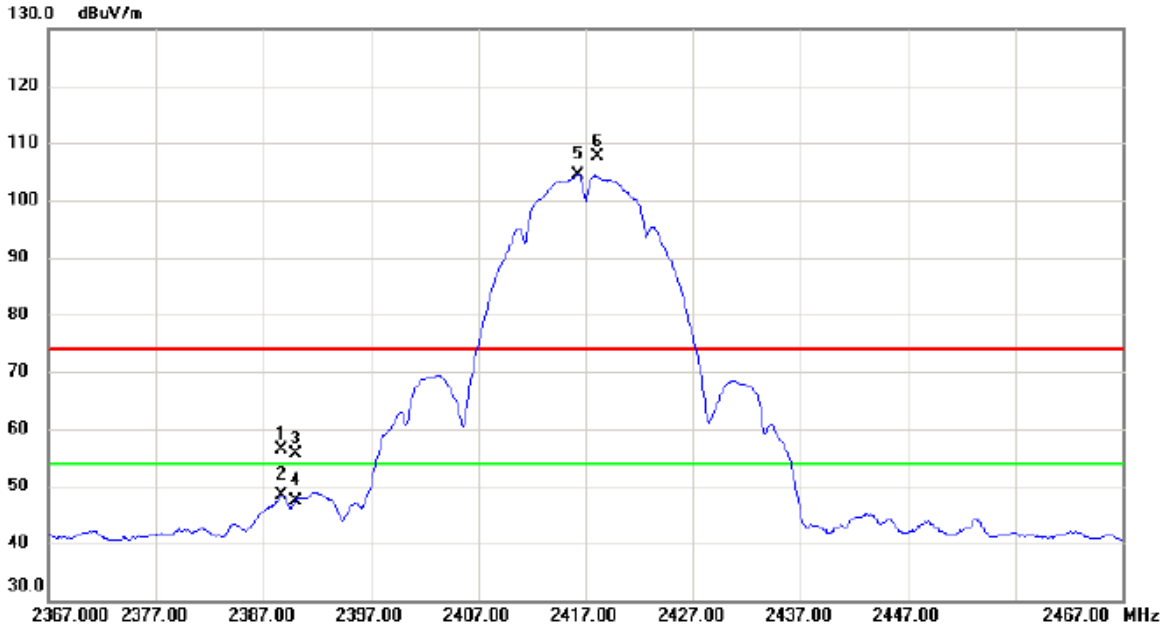

No.	Mk.	Freq. MHz	Reading Level dBuV	Correct Factor dB	Measure- ment dBuV/m	Limit dBuV/m	Margin dB	Detector	Comment
1		2388.700	46.40	10.03	56.43	74.00	-17.57	peak	
2		2388.700	38.38	10.03	48.41	54.00	-5.59	AVG	
3		2390.000	45.54	10.03	55.57	74.00	-18.43	peak	
4		2390.000	37.37	10.03	47.40	54.00	-6.60	AVG	
5	*	2416.300	94.31	10.10	104.41	54.00	50.41	AVG	No Limit
6	X	2418.200	97.53	10.11	107.64	74.00	33.64	peak	No Limit

Orthogonal Axis :	X
Test Mode :	TX B MODE 2417MHz

Vertical

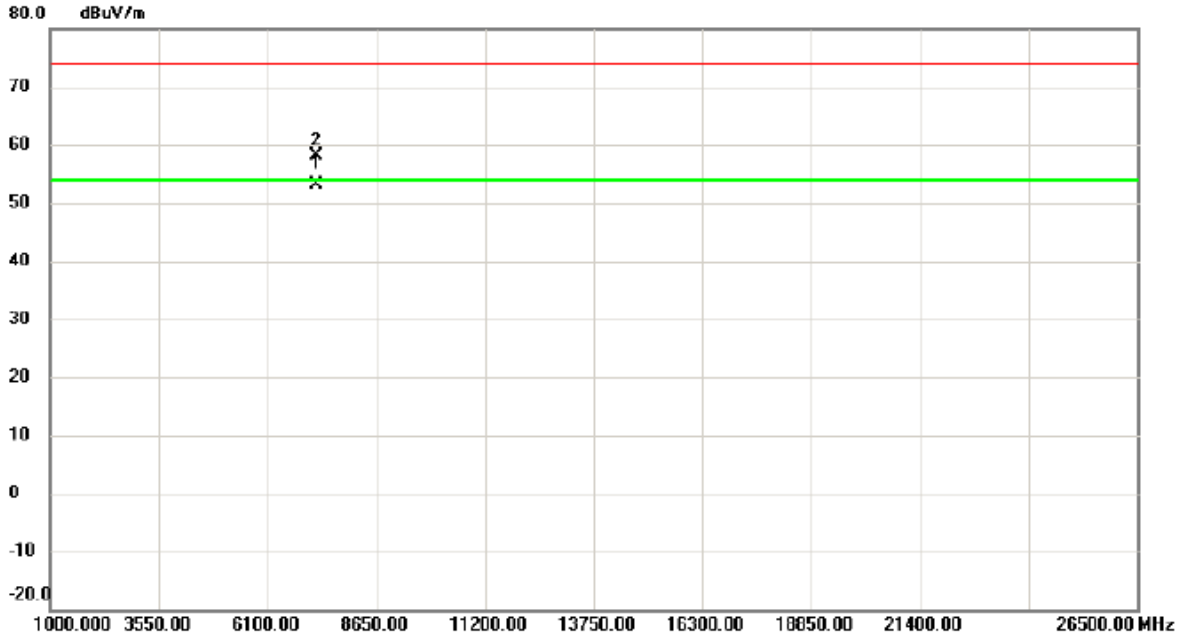

No.	Mk.	Freq. MHz	Reading Level dBuV	Correct Factor dB	Measure- ment dBuV/m	Limit dBuV/m	Margin dB	Detector	Comment
1	*	7251.860	42.30	10.74	53.04	54.00	-0.96	AVG	
2		7252.060	47.49	10.74	58.23	74.00	-15.77	peak	

Orthogonal Axis :	X
Test Mode :	TX B MODE 2417MHz

Horizontal

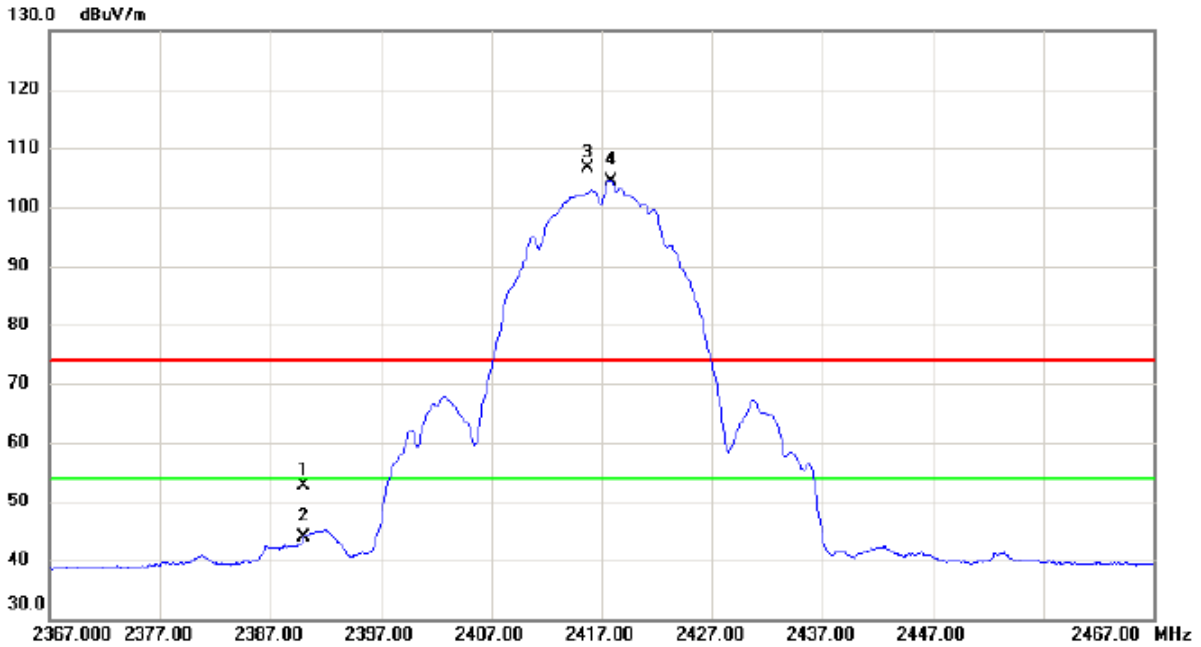

No. Mk.	Freq. MHz	Reading Level dBuV	Correct Factor dB	Measure- ment dBuV/m	Limit dBuV/m	Margin dB	Detector	Comment
1	2390.000	42.58	10.03	52.61	74.00	-21.39	peak	
2	2390.000	33.83	10.03	43.86	54.00	-10.14	AVG	
3 X	2415.700	96.46	10.10	106.56	74.00	32.56	peak	No Limit
4 *	2417.800	94.32	10.11	104.43	54.00	50.43	AVG	No Limit

Orthogonal Axis :	X
Test Mode :	TX B MODE 2417MHz

Horizontal

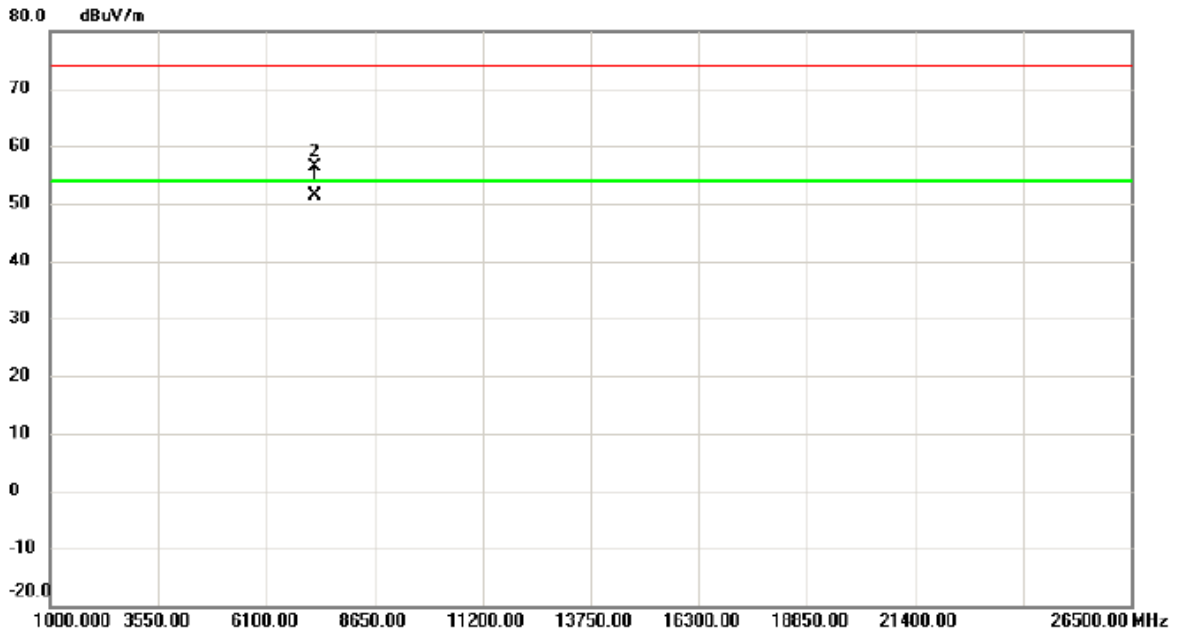

No.	Mk.	Freq. MHz	Reading Level dBuV	Correct Factor dB	Measure- ment dBuV/m	Limit dBuV/m	Margin dB	Detector	Comment
1	*	7250.100	40.65	10.74	51.39	54.00	-2.61	AVG	
2		7252.200	45.65	10.74	56.39	74.00	-17.61	peak	

Orthogonal Axis :	X
Test Mode :	TX B MODE 2437MHz

Vertical

130 dBuV/m

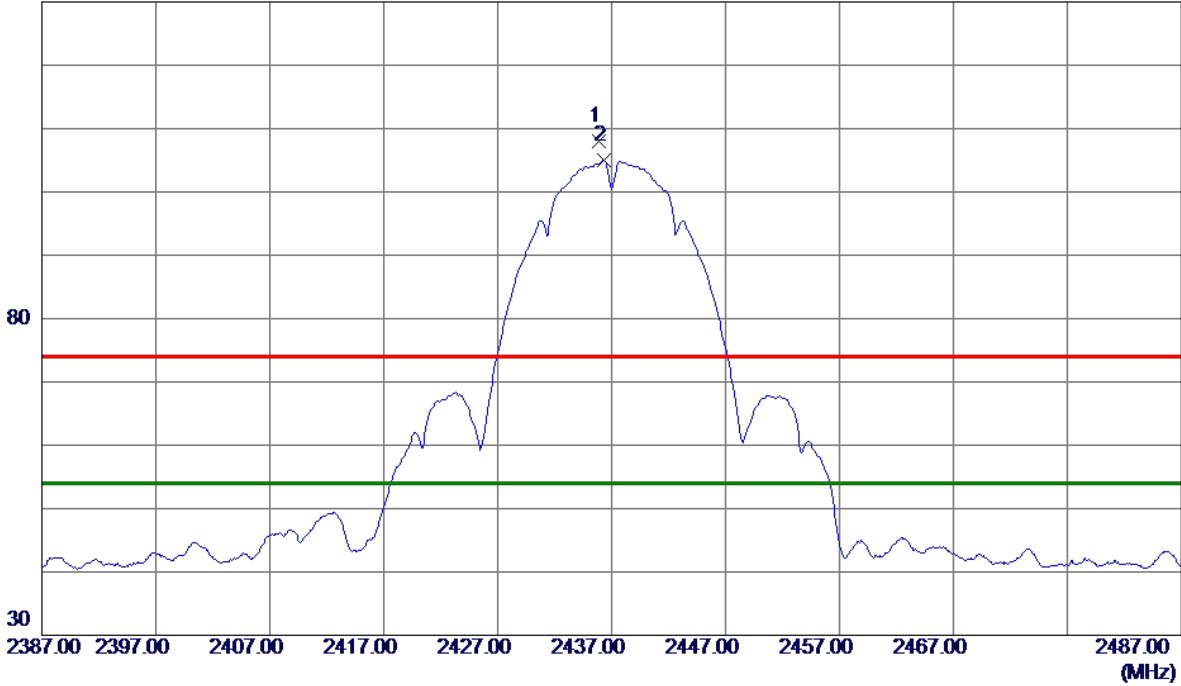

No.	Freq. MHz	Reading Level dBuV/m	Correct Factor dB	Measure ment dBuV/m	Limit dBuV/m	Margin dB	Detector	Comment
1	2435.9000	97.90	10.16	108.06	74.00	34.06	Peak	No Limit
2 *	2436.3000	94.80	10.16	104.96	54.00	50.96	AVG	No Limit

Orthogonal Axis :	X
Test Mode :	TX B MODE 2437MHz

Vertical

80 dBuV/m

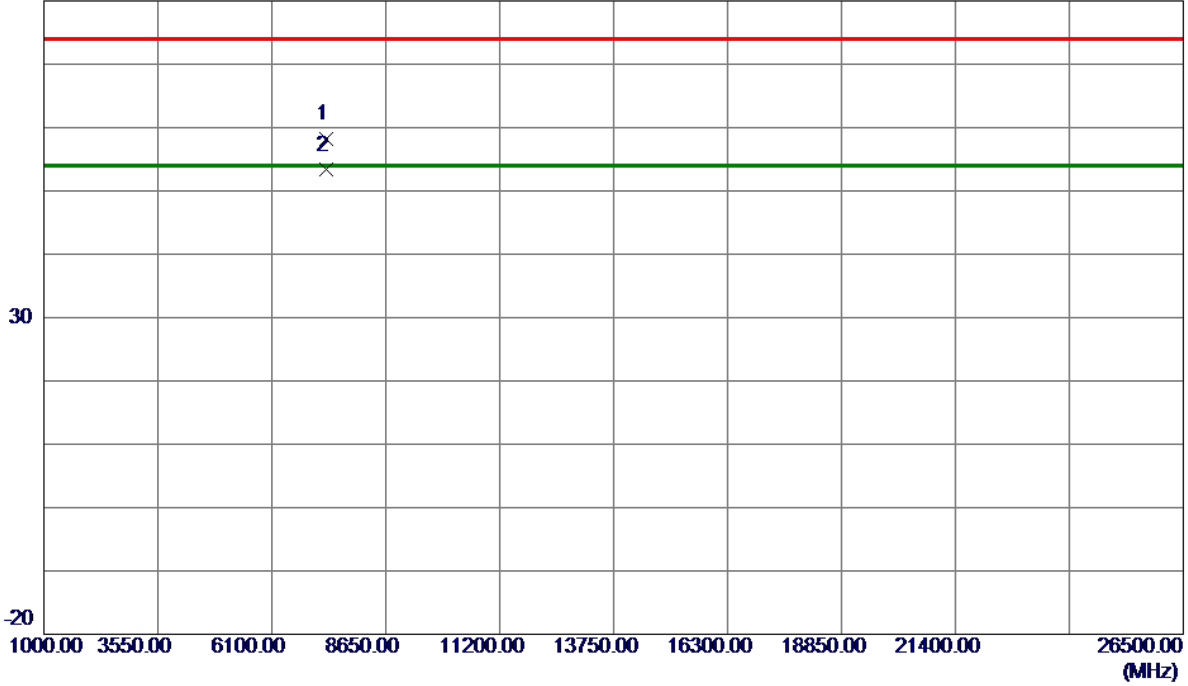

No.	Freq. MHz	Reading Level dBuV/m	Correct Factor dB	Measure ment dBuV/m	Limit dBuV/m	Margin dB	Detector	Comment
1	7309.9800	47.36	10.80	58.16	74.00	-15.84	Peak	
2 *	7310.1200	42.50	10.80	53.30	54.00	-0.70	AVG	

Orthogonal Axis :	X
Test Mode :	TX B MODE 2437MHz

Horizontal

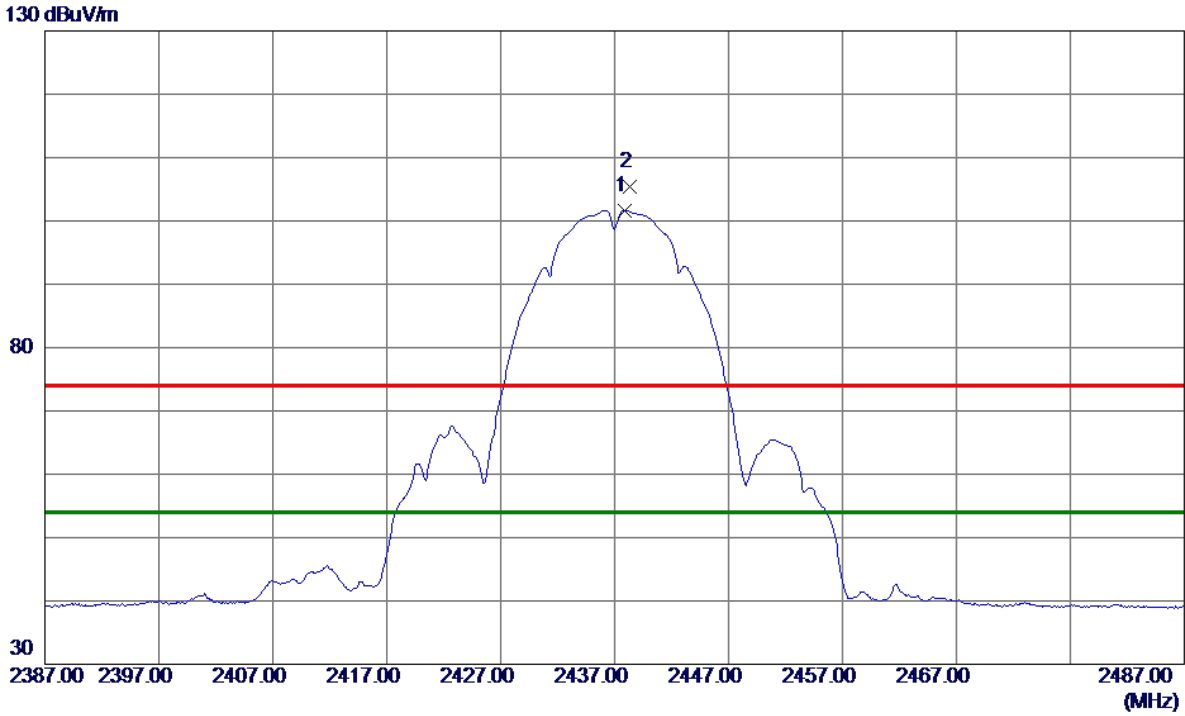

No.	Freq. MHz	Reading Level dBuV/m	Correct Factor dB	Measure ment dBuV/m	Limit dBuV/m	Margin dB	Detector	Comment
1 *	2437.9000	91.52	10.16	101.68	54.00	47.68	AVG	No Limit
2	2438.3000	95.28	10.17	105.45	74.00	31.45	Peak	No Limit

Orthogonal Axis :	X
Test Mode :	TX B MODE 2437MHz

Horizontal

80 dBuV/m

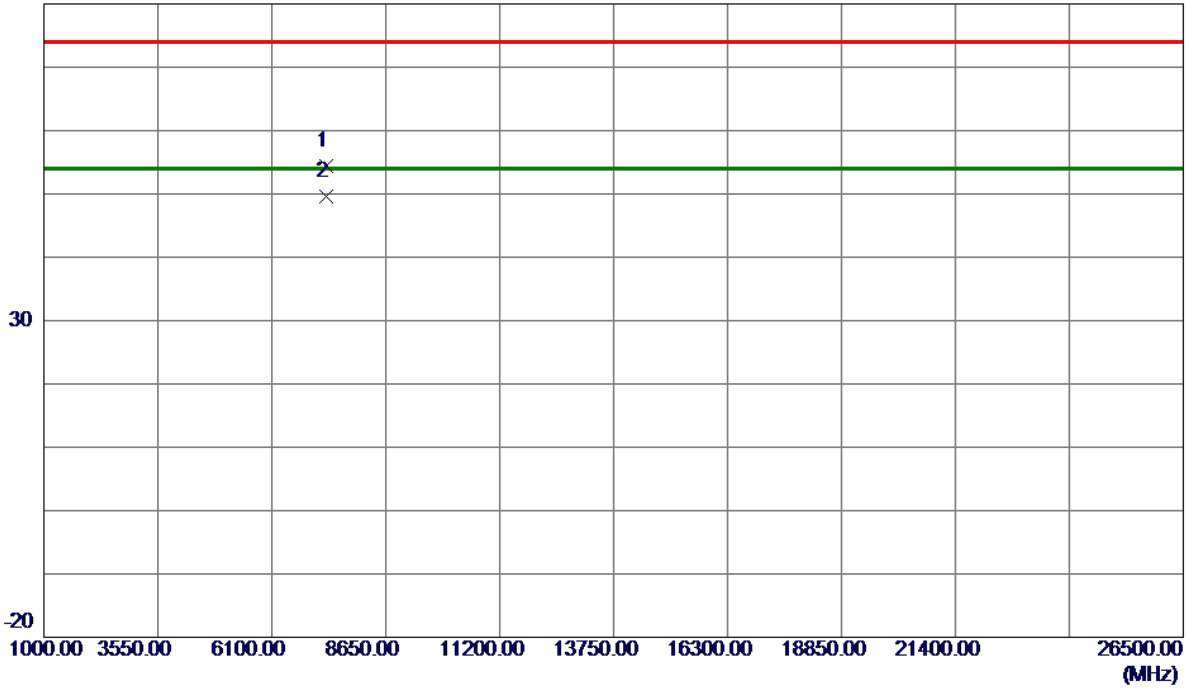

No.	Freq. MHz	Reading Level dBuV/m	Correct Factor dB	Measure ment dBuV/m	Limit dBuV/m	Margin dB	Detector	Comment
1	7312.8500	43.62	10.81	54.43	74.00	-19.57	Peak	
2 *	7313.3500	38.71	10.81	49.52	54.00	-4.48	AVG	

Orthogonal Axis :	X
Test Mode :	TX B MODE 2457MHz

Vertical

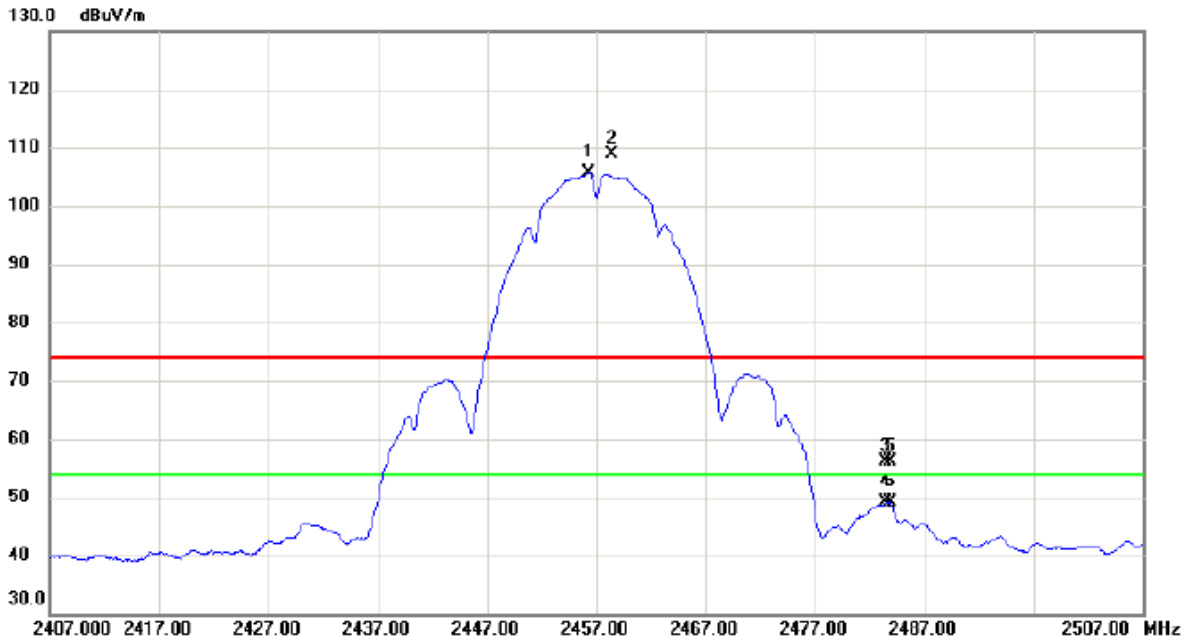

No.	Mk.	Freq. MHz	Reading Level dBuV	Correct Factor dB	Measure- ment dBuV/m	Limit dBuV/m	Margin dB	Detector	Comment
1	*	2456.300	95.44	10.22	105.66	54.00	51.66	AVG	No Limit
2	X	2458.400	98.66	10.23	108.89	74.00	34.89	peak	No Limit
3		2483.500	45.93	10.29	56.22	74.00	-17.78	peak	
4		2483.500	38.72	10.29	49.01	54.00	-4.99	AVG	
5		2483.800	45.85	10.29	56.14	74.00	-17.86	peak	
6		2483.800	38.89	10.29	49.18	54.00	-4.82	AVG	

Orthogonal Axis :	X
Test Mode :	TX B MODE 2457MHz

Vertical

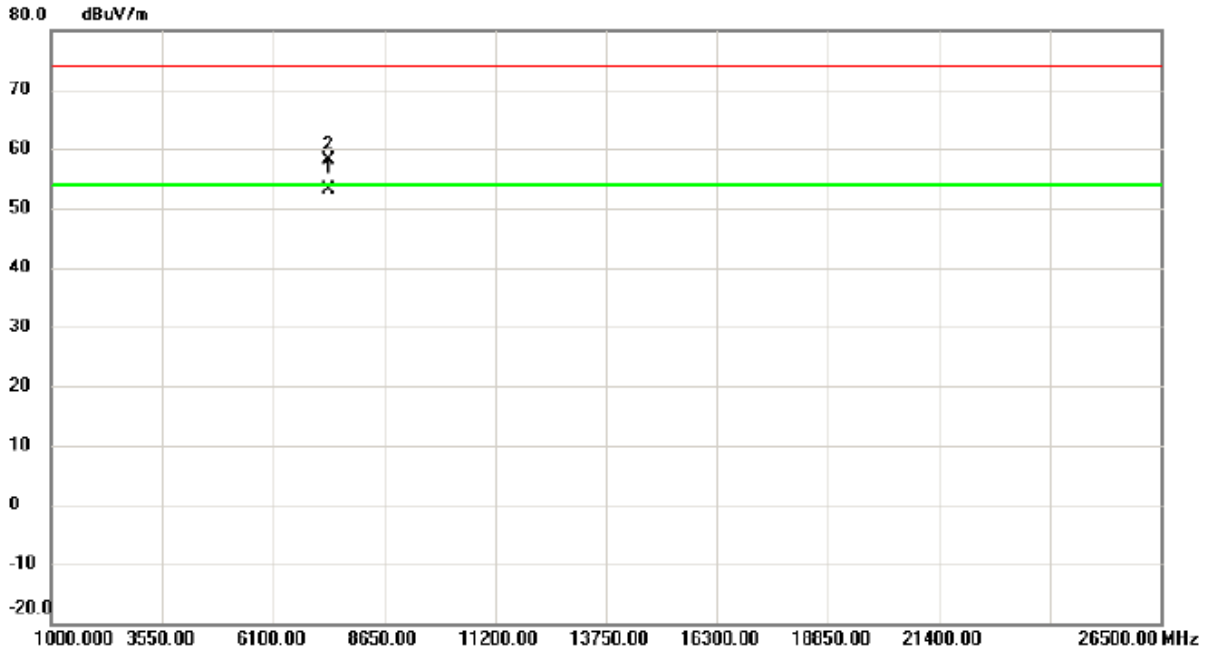

No.	Mk.	Freq. MHz	Reading Level dBuV	Correct Factor dB	Measure- ment dBuV/m	Limit dBuV/m	Margin dB	Detector	Comment
1	*	7370.120	42.31	10.86	53.17	54.00	-0.83	AVG	
2		7371.000	47.19	10.86	58.05	74.00	-15.95	peak	

Orthogonal Axis :	X
Test Mode :	TX B MODE 2457MHz

Horizontal

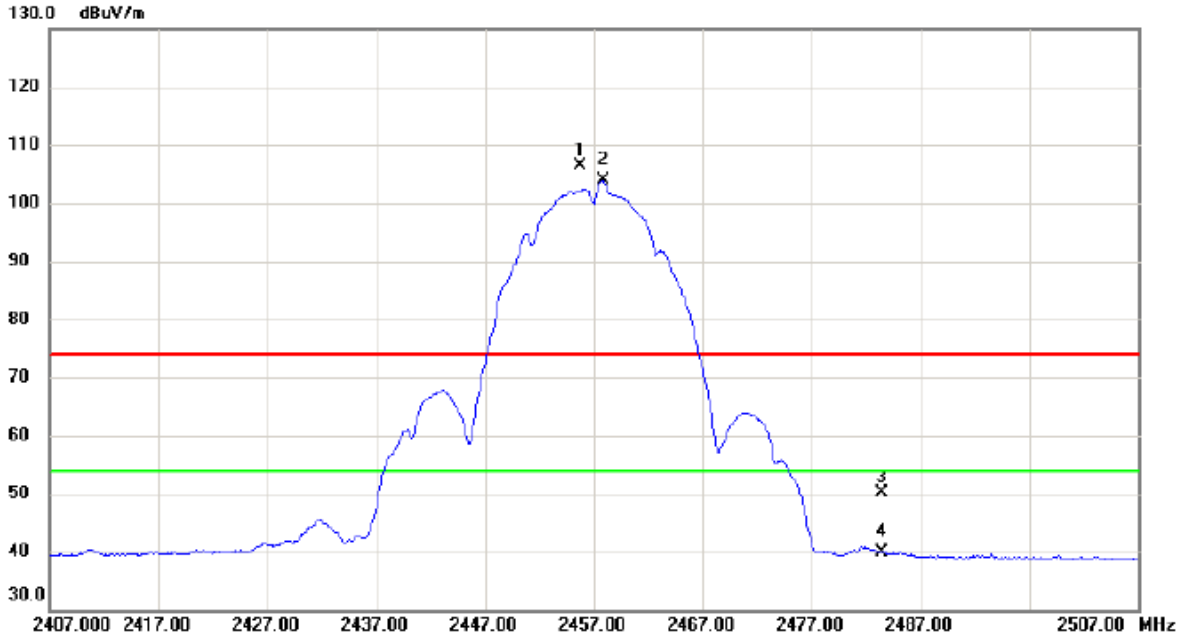

No.	Mk.	Freq. MHz	Reading Level dBuV	Correct Factor dB	Measure- ment dBuV/m	Limit dBuV/m	Margin dB	Detector	Comment
1	X	2455.700	96.09	10.21	106.30	74.00	32.30	peak	No Limit
2	*	2457.800	93.59	10.22	103.81	54.00	49.81	AVG	No Limit
3		2483.500	39.86	10.29	50.15	74.00	-23.85	peak	
4		2483.500	29.55	10.29	39.84	54.00	-14.16	AVG	

Orthogonal Axis :	X
Test Mode :	TX B MODE 2457MHz

Horizontal

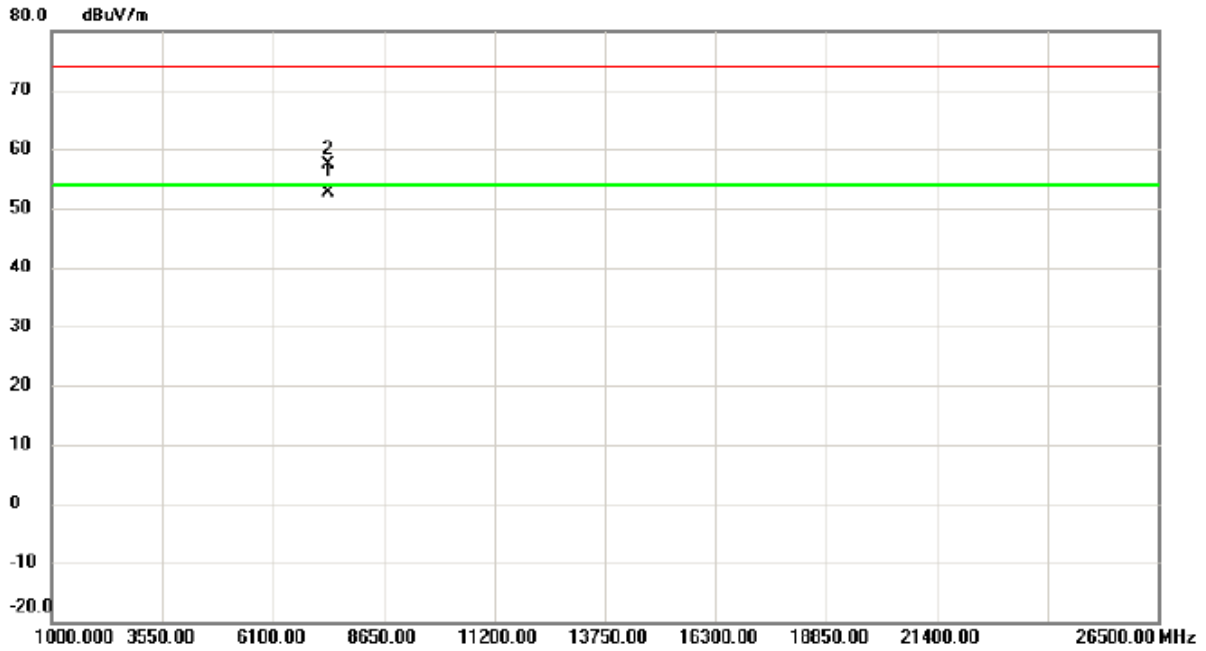

No.	Mk.	Freq. MHz	Reading Level dBuV	Correct Factor dB	Measure- ment dBuV/m	Limit dBuV/m	Margin dB	Detector	Comment
1	*	7371.900	41.70	10.86	52.56	54.00	-1.44	AVG	
2		7372.100	46.44	10.86	57.30	74.00	-16.70	peak	

Orthogonal Axis :	X
Test Mode :	TX B MODE 2462MHz

Vertical

130 dBuV/m

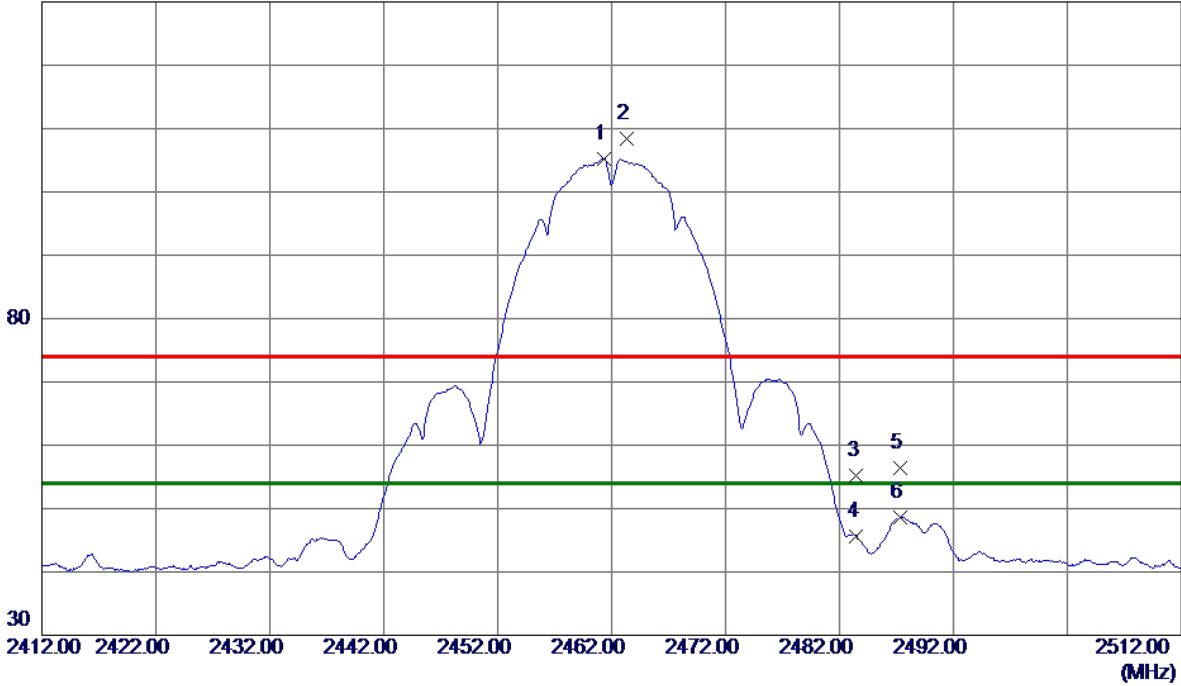

No.	Freq. MHz	Reading Level dBuV/m	Correct Factor dB	Measure ment dBuV/m	Limit dBuV/m	Margin dB	Detector	Comment
1 *	2461.3000	95.02	10.23	105.25	54.00	51.25	AVG	No Limit
2	2463.3000	98.24	10.24	108.48	74.00	34.48	Peak	No Limit
3	2483.5000	44.86	10.29	55.15	74.00	-18.85	Peak	
4	2483.5000	35.24	10.29	45.53	54.00	-8.47	AVG	
5	2487.3000	46.08	10.30	56.38	74.00	-17.62	Peak	
6	2487.3000	38.29	10.30	48.59	54.00	-5.41	AVG	

Orthogonal Axis :	X
Test Mode :	TX B MODE 2462MHz

Vertical

80 dBuV/m

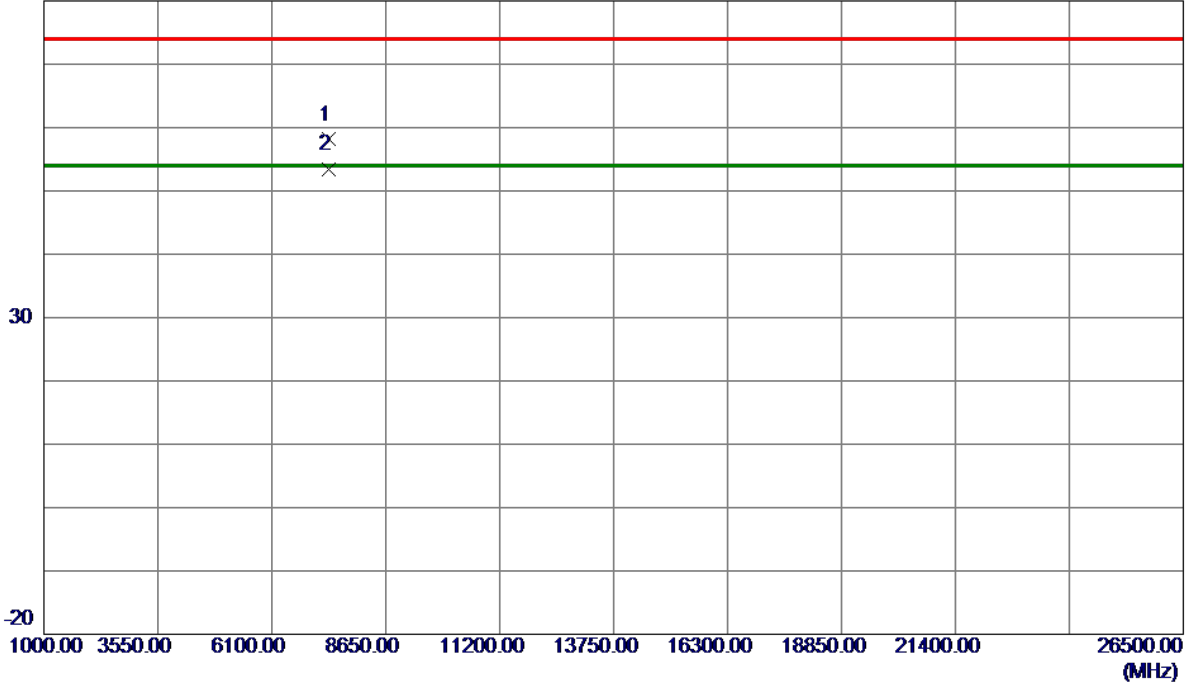

No.	Freq. MHz	Reading Level dBuV/m	Correct Factor dB	Measure ment dBuV/m	Limit dBuV/m	Margin dB	Detector	Comment
1	7384.5000	47.22	10.88	58.10	74.00	-15.90	Peak	
2 *	7385.1000	42.48	10.88	53.36	54.00	-0.64	AVG	

Orthogonal Axis :	X
Test Mode :	TX B MODE 2462MHz

Horizontal

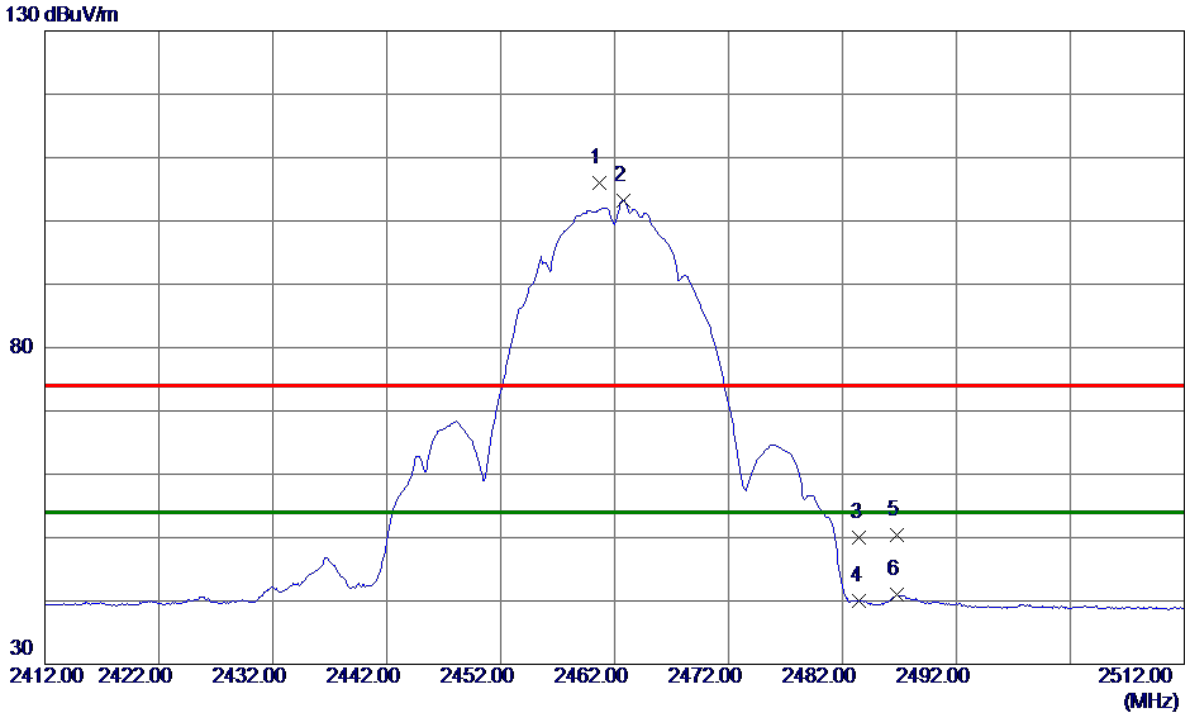

No.	Freq. MHz	Reading Level dBuV/m	Correct Factor dB	Measure ment dBuV/m	Limit dBuV/m	Margin dB	Detector	Comment
1	2460.7000	95.70	10.23	105.93	74.00	31.93	Peak	No Limit
2 *	2462.8000	92.97	10.24	103.21	54.00	49.21	AVG	No Limit
3	2483.5000	39.62	10.29	49.91	74.00	-24.09	Peak	
4	2483.5000	29.64	10.29	39.93	54.00	-14.07	AVG	
5	2486.8000	40.17	10.30	50.47	74.00	-23.53	Peak	
6	2486.8000	30.64	10.30	40.94	54.00	-13.06	AVG	

Orthogonal Axis :	X
Test Mode :	TX B MODE 2462MHz

Horizontal

80 dBuV/m

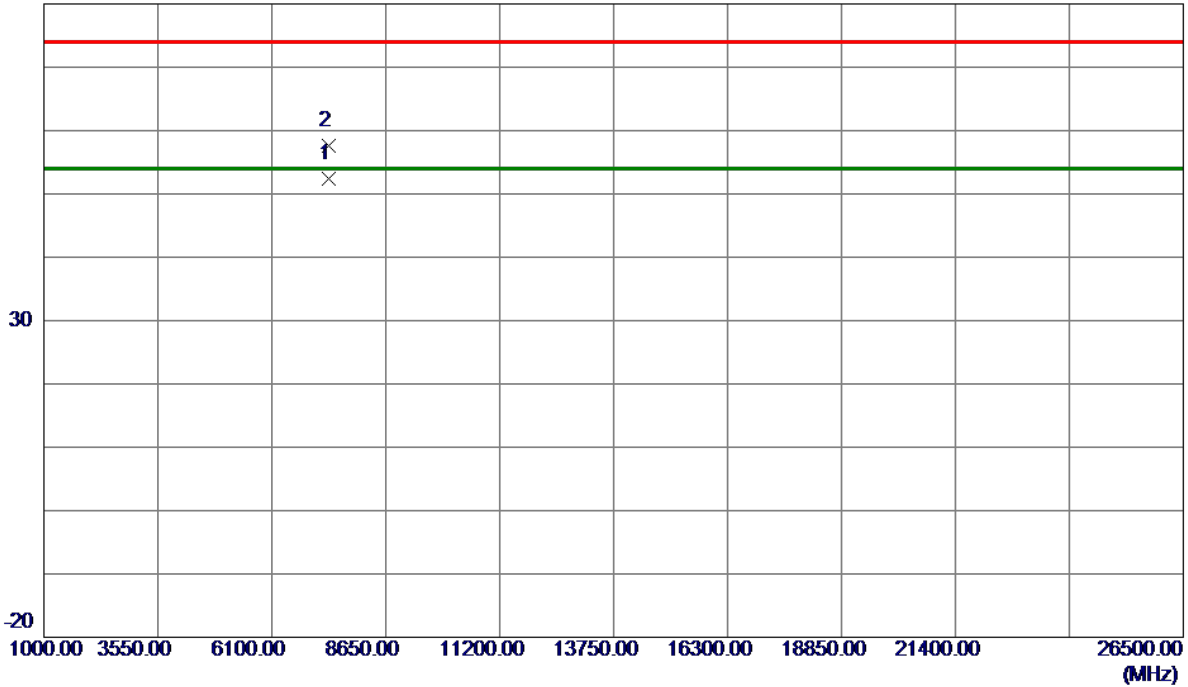

No.	Freq. MHz	Reading Level dBuV/m	Correct Factor dB	Measure ment dBuV/m	Limit dBuV/m	Margin dB	Detector	Comment
1 *	7385.0500	41.61	10.88	52.49	54.00	-1.51	AVG	
2	7385.8500	46.73	10.88	57.61	74.00	-16.39	Peak	

Orthogonal Axis :	X
Test Mode :	TX G MODE 2412MHz

Vertical

130 dBuV/m

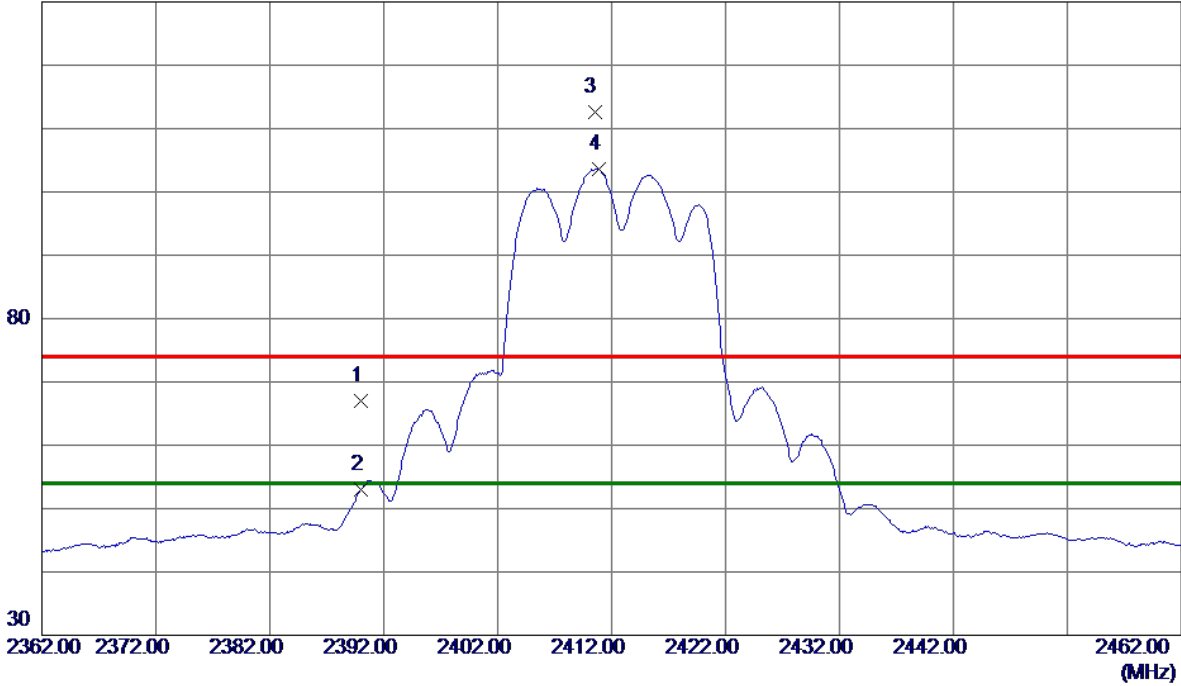

No.	Freq. MHz	Reading Level dBuV/m	Correct Factor dB	Measure ment dBuV/m	Limit dBuV/m	Margin dB	Detector	Comment
1	2390.0000	57.02	10.03	67.05	74.00	-6.95	Peak	
2	2390.0000	43.04	10.03	53.07	54.00	-0.93	AVG	
3	2410.5000	102.49	10.09	112.58	74.00	38.58	Peak	No Limit
4 *	2410.9000	93.49	10.09	103.58	54.00	49.58	AVG	No Limit

Orthogonal Axis :	X
Test Mode :	TX G MODE 2412MHz

Vertical

80 dBuV/m

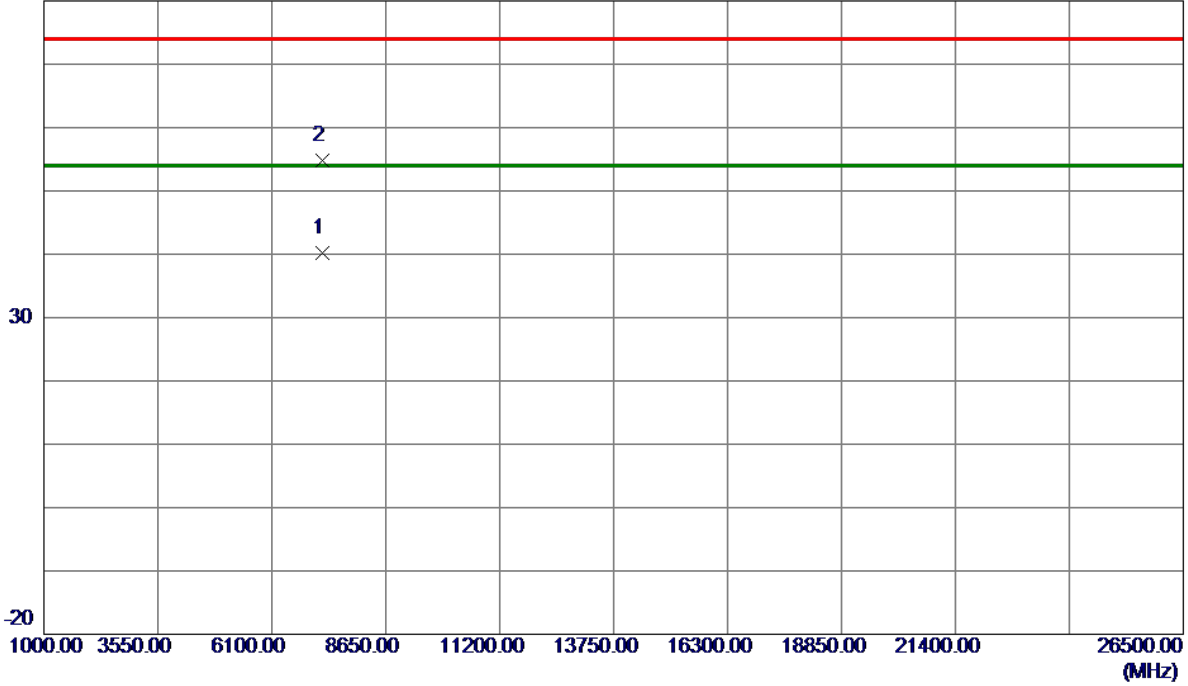

No.	Freq. MHz	Reading Level dBuV/m	Correct Factor dB	Measure ment dBuV/m	Limit dBuV/m	Margin dB	Detector	Comment
1 *	7235.8500	29.39	10.73	40.12	54.00	-13.88	AVG	
2	7236.7000	44.15	10.73	54.88	74.00	-19.12	Peak	

Orthogonal Axis :	X
Test Mode :	TX G MODE 2412MHz

Horizontal

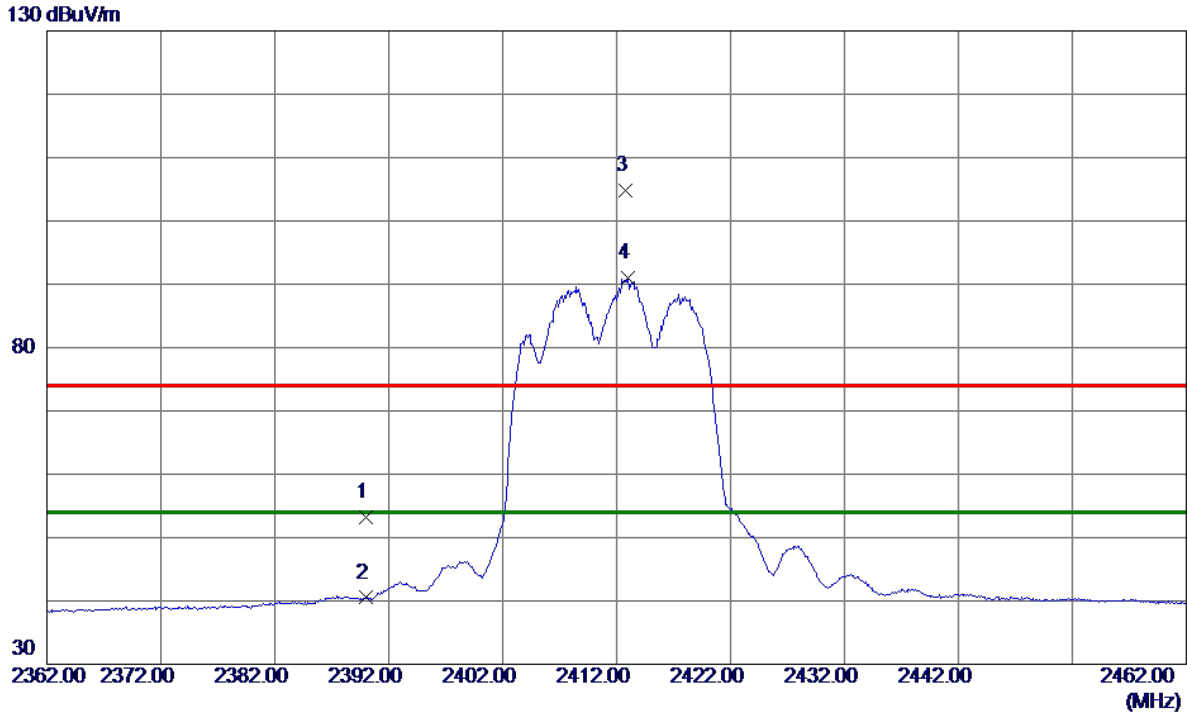

No.	Freq. MHz	Reading Level dBuV/m	Correct Factor dB	Measure ment dBuV/m	Limit dBuV/m	Margin dB	Detector	Comment
1	2390.0000	43.16	10.03	53.19	74.00	-20.81	Peak	
2	2390.0000	30.47	10.03	40.50	54.00	-13.50	AVG	
3	2412.8000	94.80	10.09	104.89	74.00	30.89	Peak	No Limit
4 *	2413.0000	80.89	10.09	90.98	54.00	36.98	AVG	No Limit

Orthogonal Axis :	X
Test Mode :	TX G MODE 2412MHz

Horizontal

80 dBuV/m

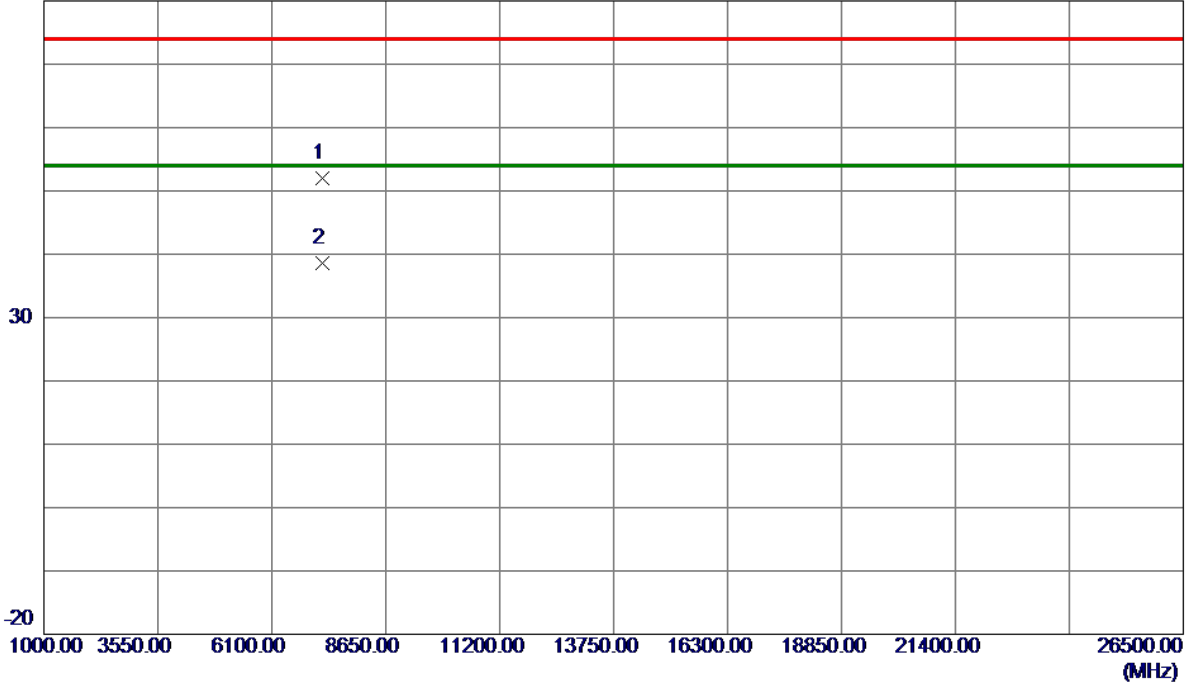

No.	Freq. MHz	Reading Level dBuV/m	Correct Factor dB	Measure ment dBuV/m	Limit dBuV/m	Margin dB	Detector	Comment
1	7230.8500	41.27	10.73	52.00	74.00	-22.00	Peak	
2 *	7234.9500	27.79	10.73	38.52	54.00	-15.48	AVG	

Orthogonal Axis :	X
Test Mode :	TX G MODE 2417MHz

Vertical

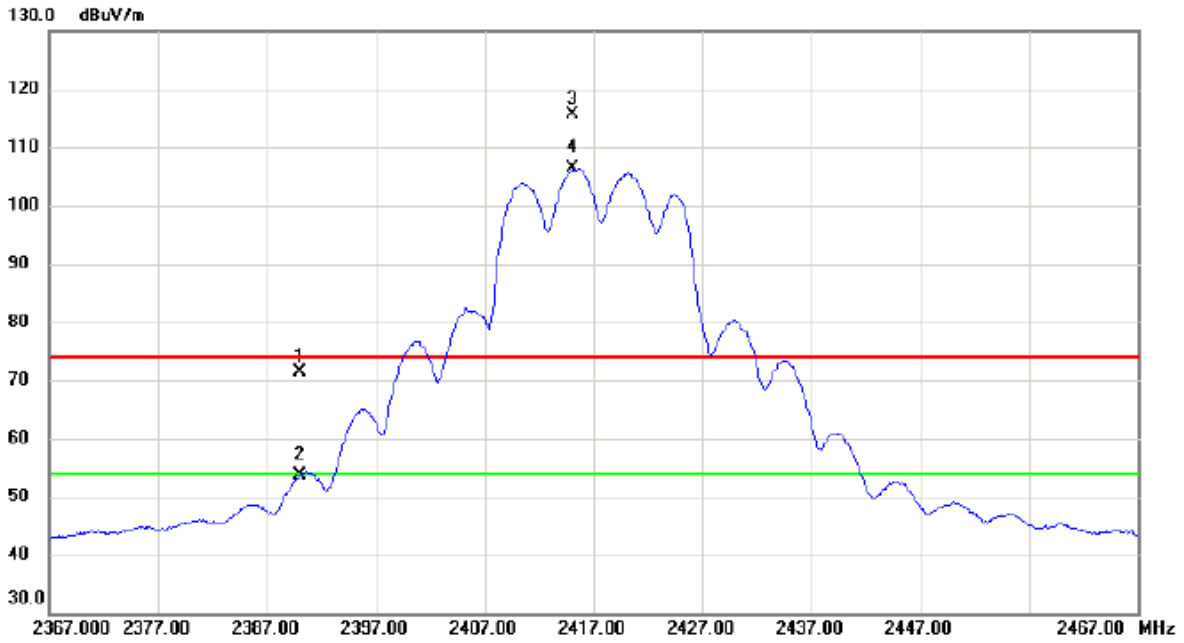

No.	Mk.	Freq. MHz	Reading Level dBuV	Correct Factor dB	Measure- ment dBuV/m	Limit dBuV/m	Margin dB	Detector	Comment
1		2390.000	61.42	10.03	71.45	74.00	-2.55	peak	
2		2390.000	43.51	10.03	53.54	54.00	-0.46	AVG	
3	X	2415.100	105.5	10.10	115.63	74.00	41.63	peak	No Limit
4	*	2415.100	96.23	10.10	106.33	54.00	52.33	AVG	No Limit

Orthogonal Axis :	X
Test Mode :	TX G MODE 2417MHz

Vertical

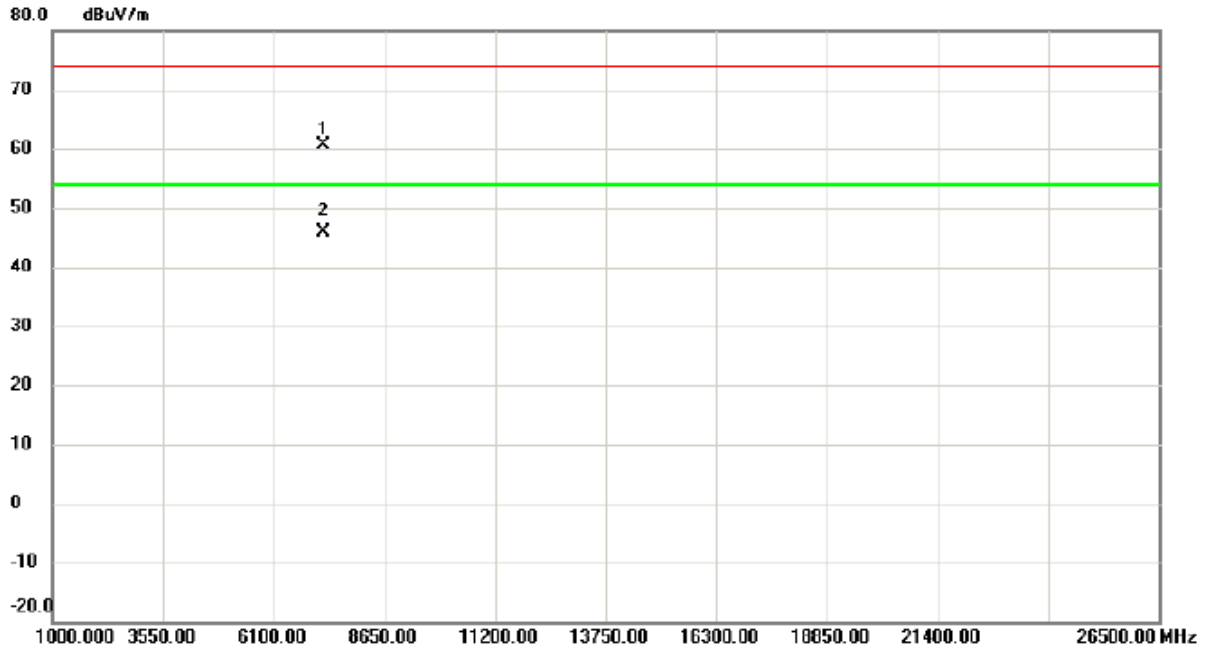

No.	Mk.	Freq.	Reading Level	Correct Factor	Measurement	Limit	Margin	Detector	Comment
		MHz	dBuV	dB	dBuV/m	dBuV/m	dB		
1		7249.800	49.90	10.75	60.65	74.00	-13.35	peak	
2	*	7250.750	35.04	10.74	45.78	54.00	-8.22	AVG	

Orthogonal Axis :	X
Test Mode :	TX G MODE 2417MHz

Horizontal

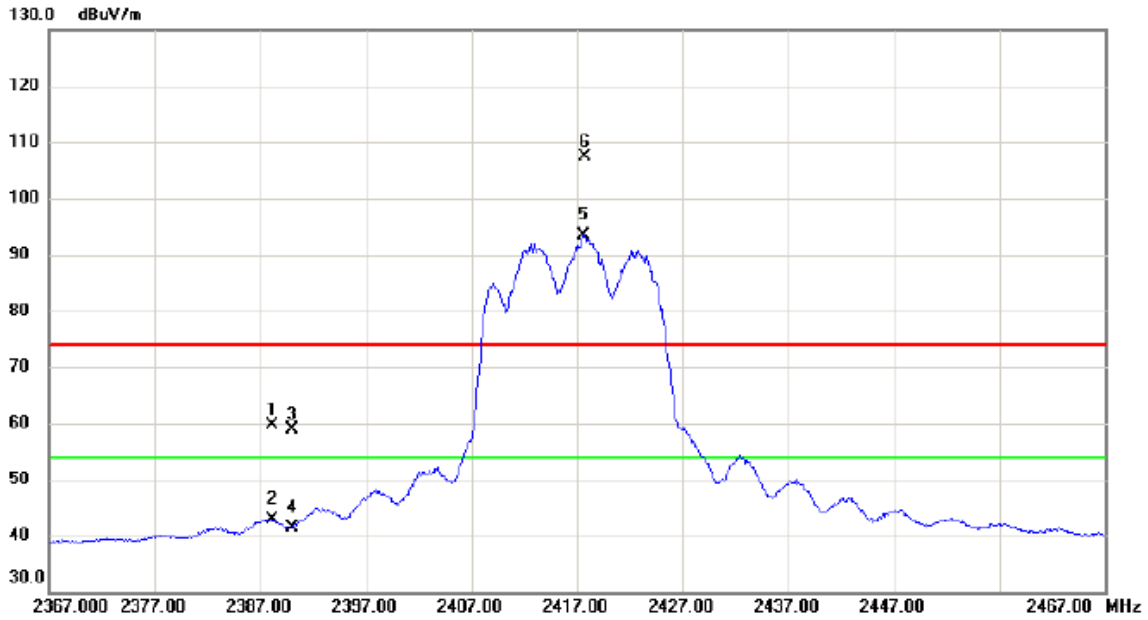

No.	Mk.	Freq. MHz	Reading Level dBuV	Correct Factor dB	Measure- ment dBuV/m	Limit dBuV/m	Margin dB	Detector	Comment
1		2388.100	49.53	10.03	59.56	74.00	-14.44	peak	
2		2388.100	32.91	10.03	42.94	54.00	-11.06	AVG	
3		2390.000	48.73	10.03	58.76	74.00	-15.24	peak	
4		2390.000	31.47	10.03	41.50	54.00	-12.50	AVG	
5	*	2417.600	83.27	10.11	93.38	54.00	39.38	AVG	No Limit
6	X	2417.700	97.23	10.11	107.34	74.00	33.34	peak	No Limit

Orthogonal Axis :	X
Test Mode :	TX G MODE 2417MHz

Horizontal

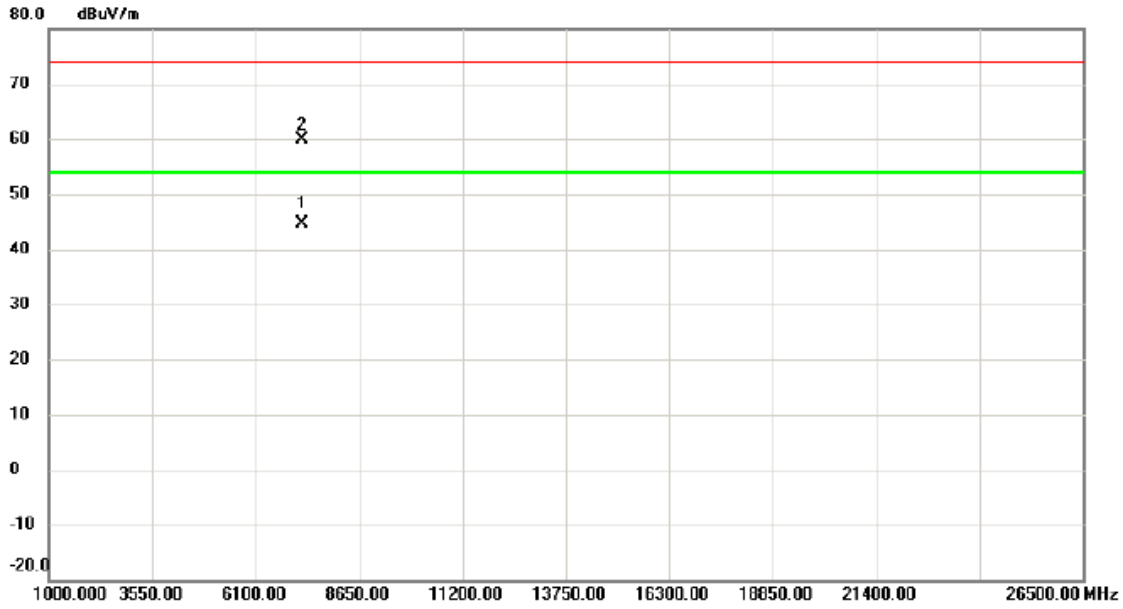

No.	Mk.	Freq. MHz	Reading Level dBuV	Correct Factor dB	Measure- ment dBuV/m	Limit dBuV/m	Margin dB	Detector	Comment
1	*	7250.200	33.99	10.74	44.73	54.00	-9.27	AVG	
2		7250.450	49.05	10.74	59.79	74.00	-14.21	peak	

Orthogonal Axis :	X
Test Mode :	TX G MODE 2437MHz

Vertical

130 dBuV/m

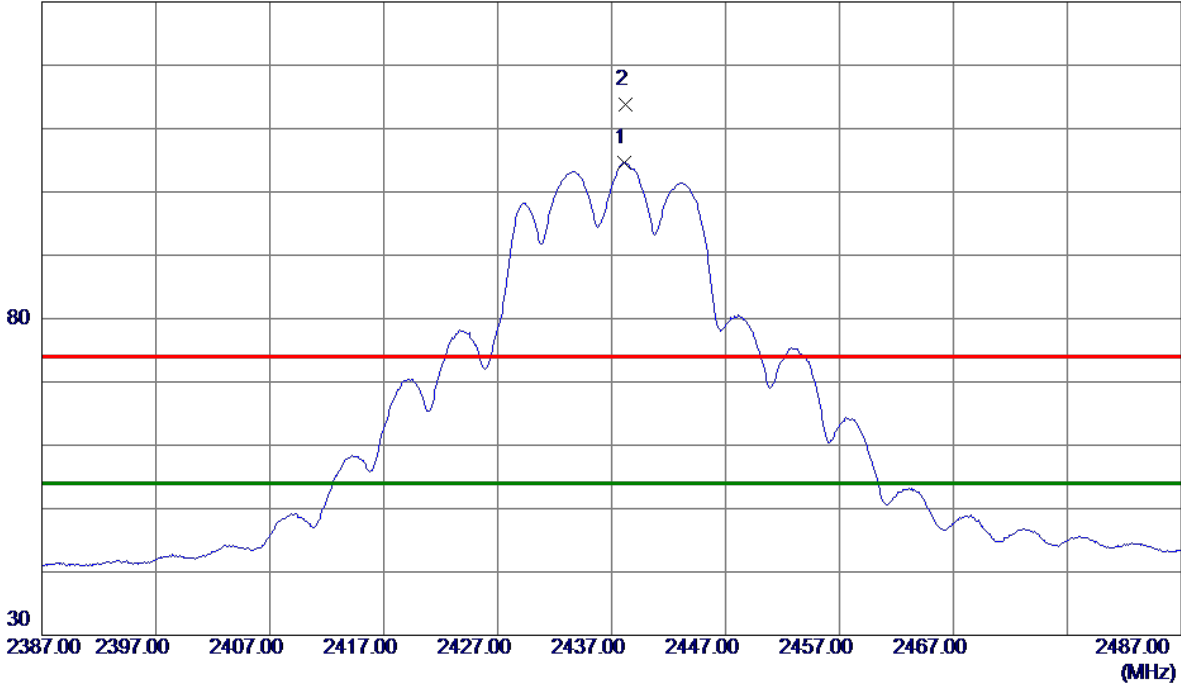

No.	Freq. MHz	Reading Level dBuV/m	Correct Factor dB	Measure ment dBuV/m	Limit dBuV/m	Margin dB	Detector	Comment
1 *	2438.1000	94.43	10.17	104.60	54.00	50.60	AVG	No Limit
2	2438.2000	103.69	10.17	113.86	74.00	39.86	Peak	No Limit

Orthogonal Axis :	X
Test Mode :	TX G MODE 2437MHz

Vertical

80 dBuV/m

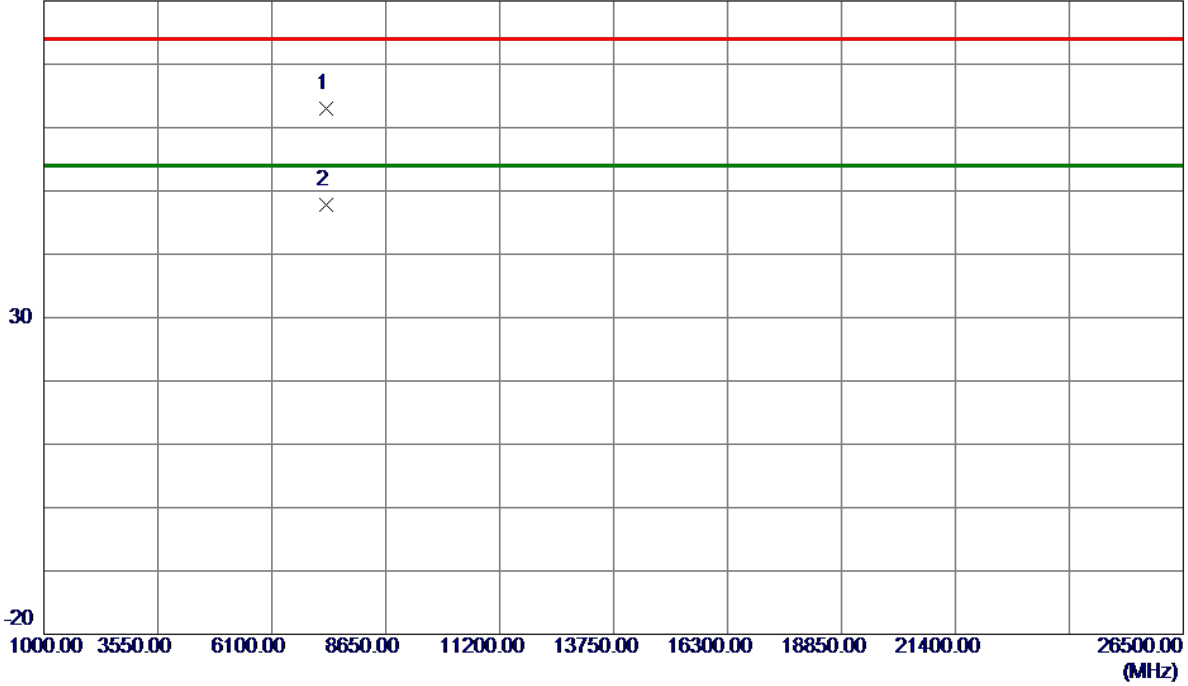

No.	Freq. MHz	Reading Level dBuV/m	Correct Factor dB	Measure ment dBuV/m	Limit dBuV/m	Margin dB	Detector	Comment
1	7306.4000	52.24	10.80	63.04	74.00	-10.96	Peak	
2 *	7311.0500	36.94	10.80	47.74	54.00	-6.26	AVG	

Orthogonal Axis :	X
Test Mode :	TX G MODE 2437MHz

Horizontal

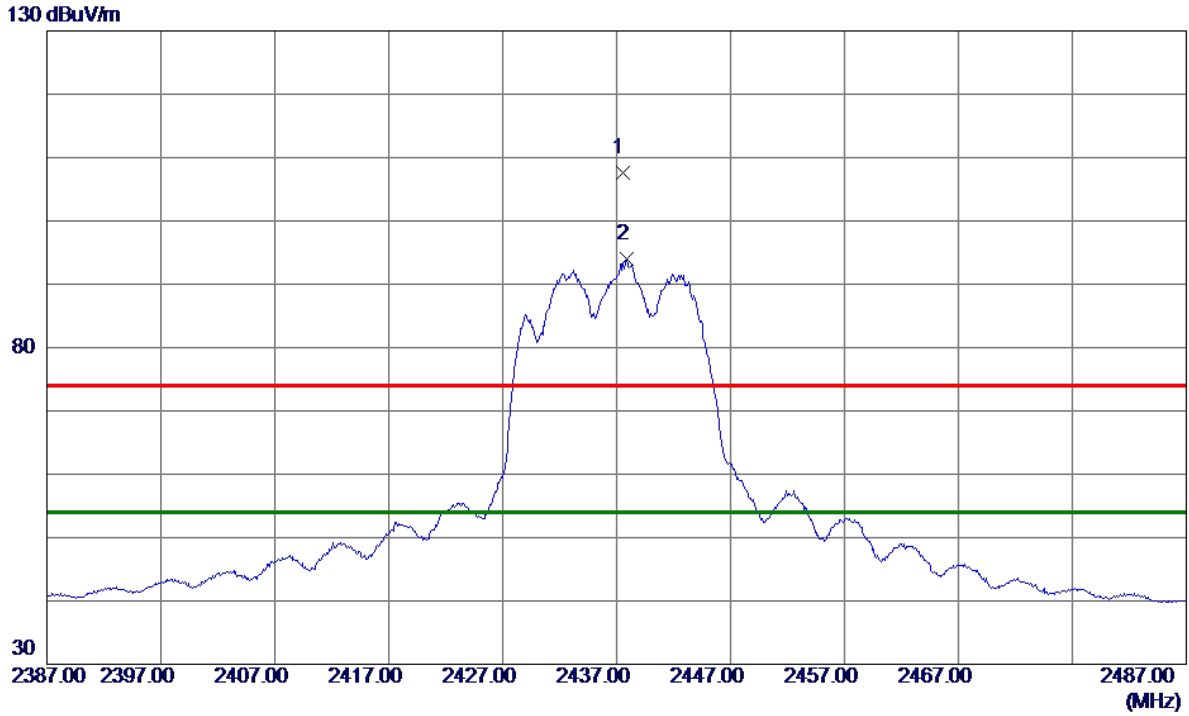

No.	Freq. MHz	Reading Level dBuV/m	Correct Factor dB	Measure ment dBuV/m	Limit dBuV/m	Margin dB	Detector	Comment
1	2437.5000	97.38	10.16	107.54	74.00	33.54	Peak	No Limit
2 *	2437.9000	83.75	10.16	93.91	54.00	39.91	AVG	No Limit

Orthogonal Axis :	X
Test Mode :	TX G MODE 2437MHz

Horizontal

80 dBuV/m

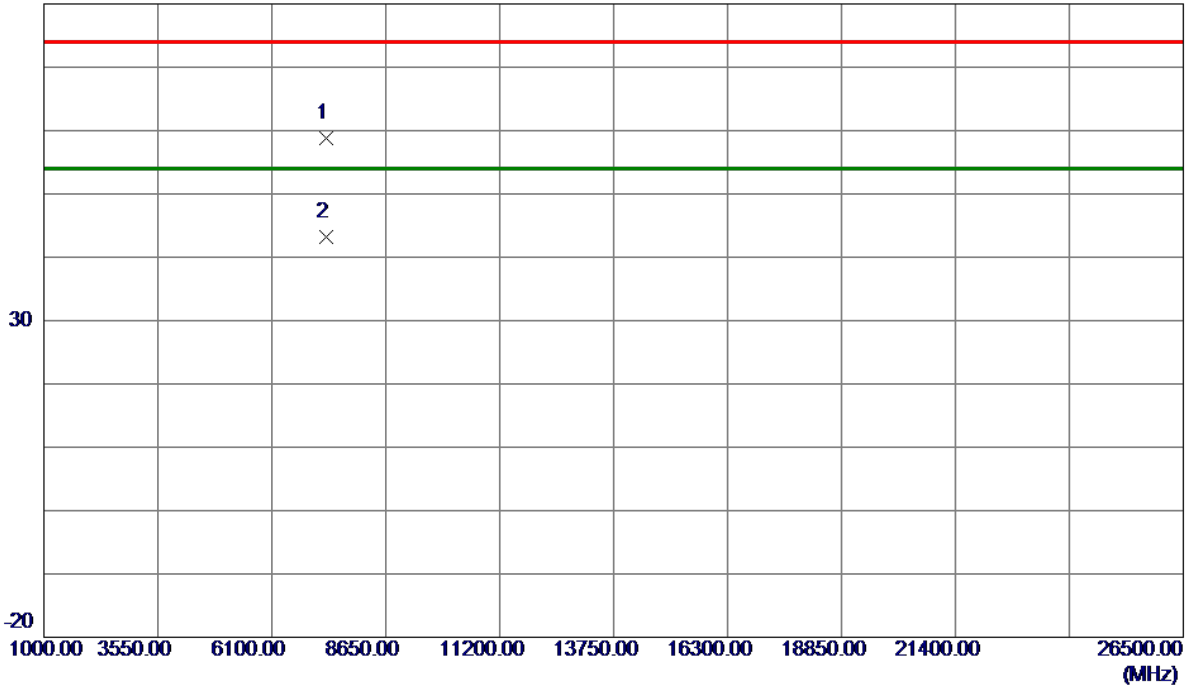

No.	Freq. MHz	Reading Level dBuV/m	Correct Factor dB	Measure ment dBuV/m	Limit dBuV/m	Margin dB	Detector	Comment
1	7306.4000	47.94	10.80	58.74	74.00	-15.26	Peak	
2 *	7311.0000	32.49	10.80	43.29	54.00	-10.71	AVG	

Orthogonal Axis :	X
Test Mode :	TX G MODE 2457MHz

Vertical

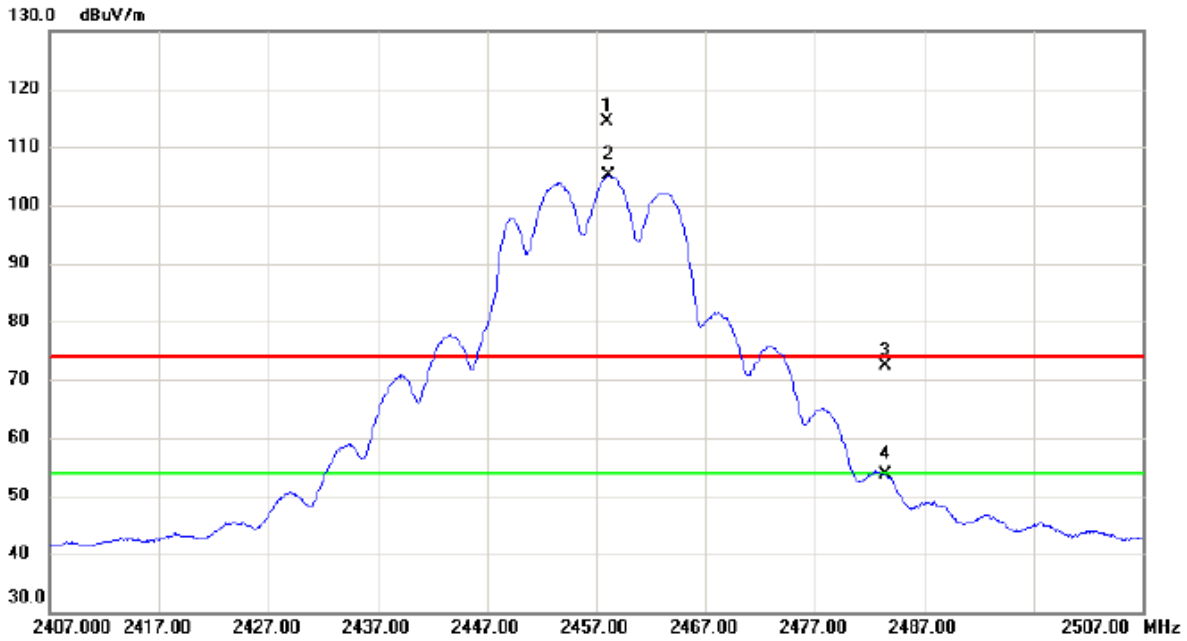

No.	Mk.	Freq. MHz	Reading Level dBuV	Correct Factor dB	Measure- ment dBuV/m	Limit dBuV/m	Margin dB	Detector	Comment
1	X	2458.000	104.0	10.22	114.30	74.00	40.30	peak	No Limit
2	*	2458.200	94.96	10.22	105.18	54.00	51.18	AVG	No Limit
3		2483.500	62.21	10.29	72.50	74.00	-1.50	peak	
4		2483.500	43.28	10.29	53.57	54.00	-0.43	AVG	

Orthogonal Axis :	X
Test Mode :	TX G MODE 2457MHz

Vertical

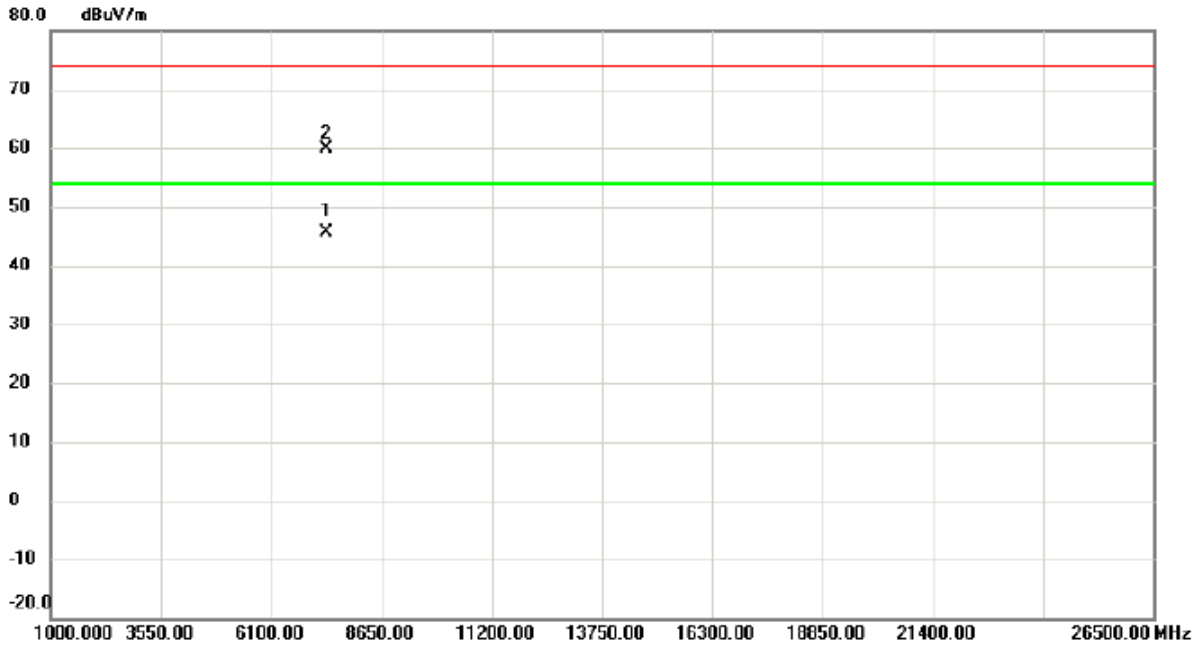

No.	Mk.	Freq. MHz	Reading Level dBuV	Correct Factor dB	Measure- ment dBuV/m	Limit dBuV/m	Margin dB	Detector	Comment
1	*	7371.000	34.82	10.86	45.68	54.00	-8.32	AVG	
2		7371.450	48.91	10.86	59.77	74.00	-14.23	peak	

Orthogonal Axis :	X
Test Mode :	TX G MODE 2457MHz

Horizontal

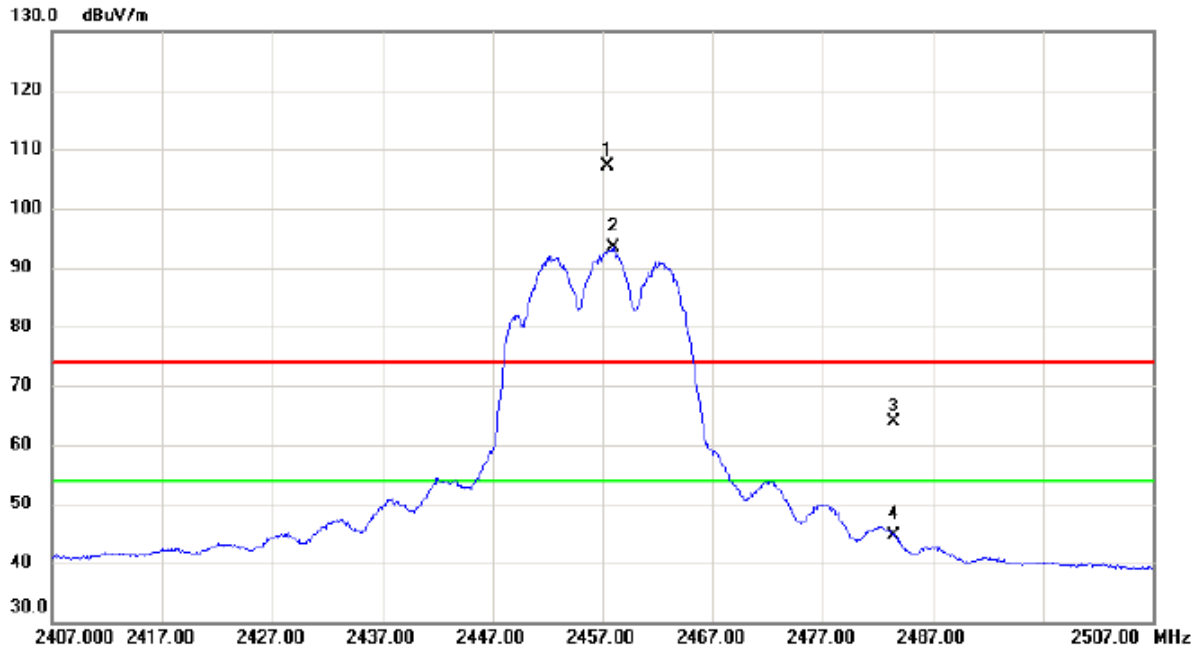

No.	Mk.	Freq. MHz	Reading Level dBuV	Correct Factor dB	Measure- ment dBuV/m	Limit dBuV/m	Margin dB	Detector	Comment
1	X	2457.500	96.97	10.22	107.19	74.00	33.19	peak	No Limit
2	*	2458.000	83.04	10.22	93.26	54.00	39.26	AVG	No Limit
3		2483.500	53.61	10.29	63.90	74.00	-10.10	peak	
4		2483.500	34.26	10.29	44.55	54.00	-9.45	AVG	

Orthogonal Axis :	X
Test Mode :	TX G MODE 2457MHz

Horizontal

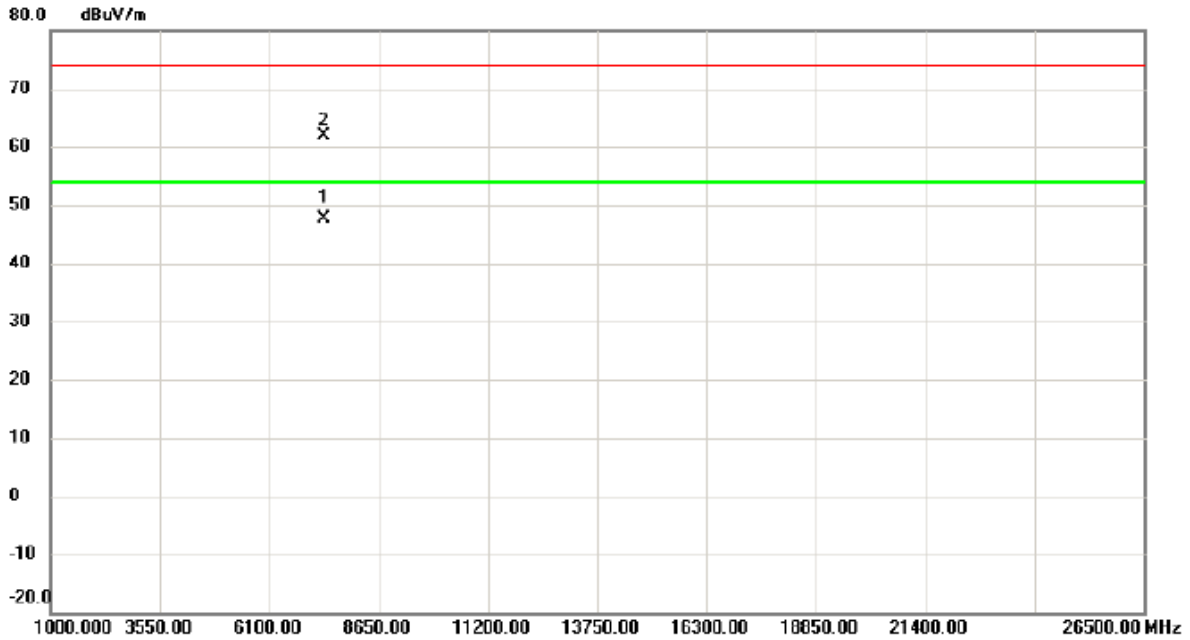

No.	Mk.	Freq. MHz	Reading Level dBuV	Correct Factor dB	Measure- ment dBuV/m	Limit dBuV/m	Margin dB	Detector	Comment
1	*	7370.900	36.77	10.86	47.63	54.00	-6.37	AVG	
2		7380.950	50.96	10.87	61.83	74.00	-12.17	peak	

Orthogonal Axis :	X
Test Mode :	TX G MODE 2462MHz

Vertical

130 dBuV/m

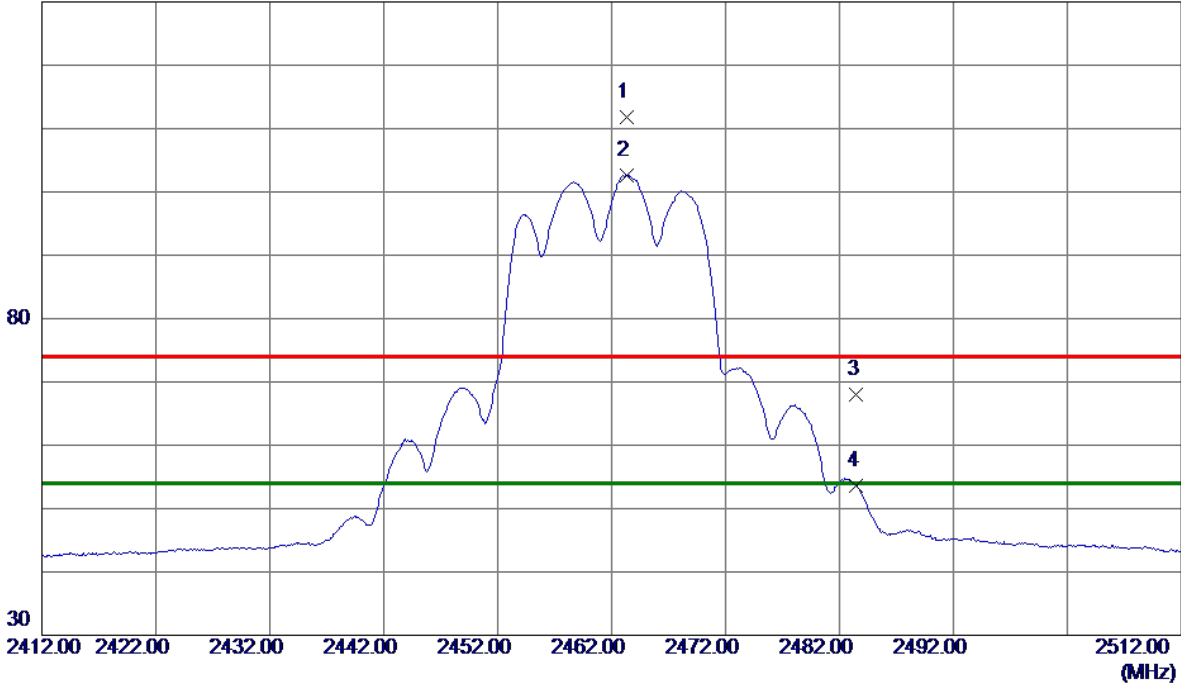

No.	Freq. MHz	Reading Level dBuV/m	Correct Factor dB	Measure ment dBuV/m	Limit dBuV/m	Margin dB	Detector	Comment
1	2463.3000	101.50	10.24	111.74	74.00	37.74	Peak	No Limit
2 *	2463.3000	92.34	10.24	102.58	54.00	48.58	AVG	No Limit
3	2483.5000	57.71	10.29	68.00	74.00	-6.00	Peak	
4	2483.5000	43.37	10.29	53.66	54.00	-0.34	AVG	

Orthogonal Axis :	X
Test Mode :	TX G MODE 2462MHz

Vertical

80 dBuV/m

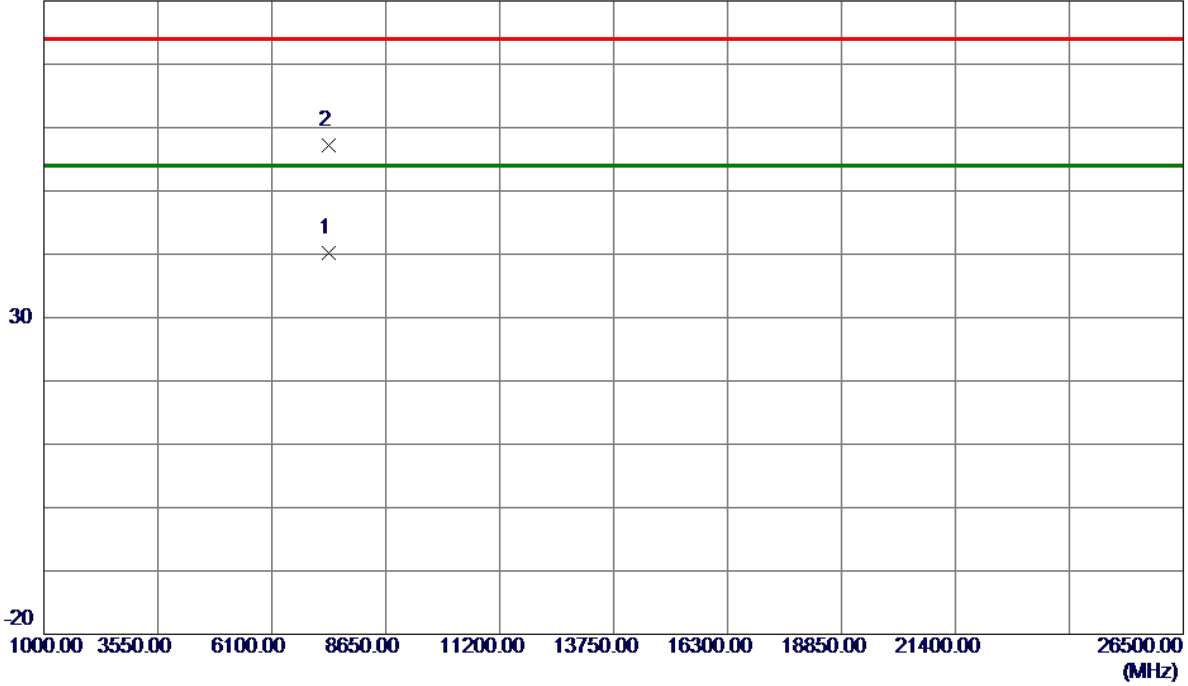

No.	Freq. MHz	Reading Level dBuV/m	Correct Factor dB	Measure ment dBuV/m	Limit dBuV/m	Margin dB	Detector	Comment
1 *	7386.6000	29.36	10.88	40.24	54.00	-13.76	AVG	
2	7386.6500	46.24	10.88	57.12	74.00	-16.88	Peak	

Orthogonal Axis :	X
Test Mode :	TX G MODE 2462MHz

Horizontal

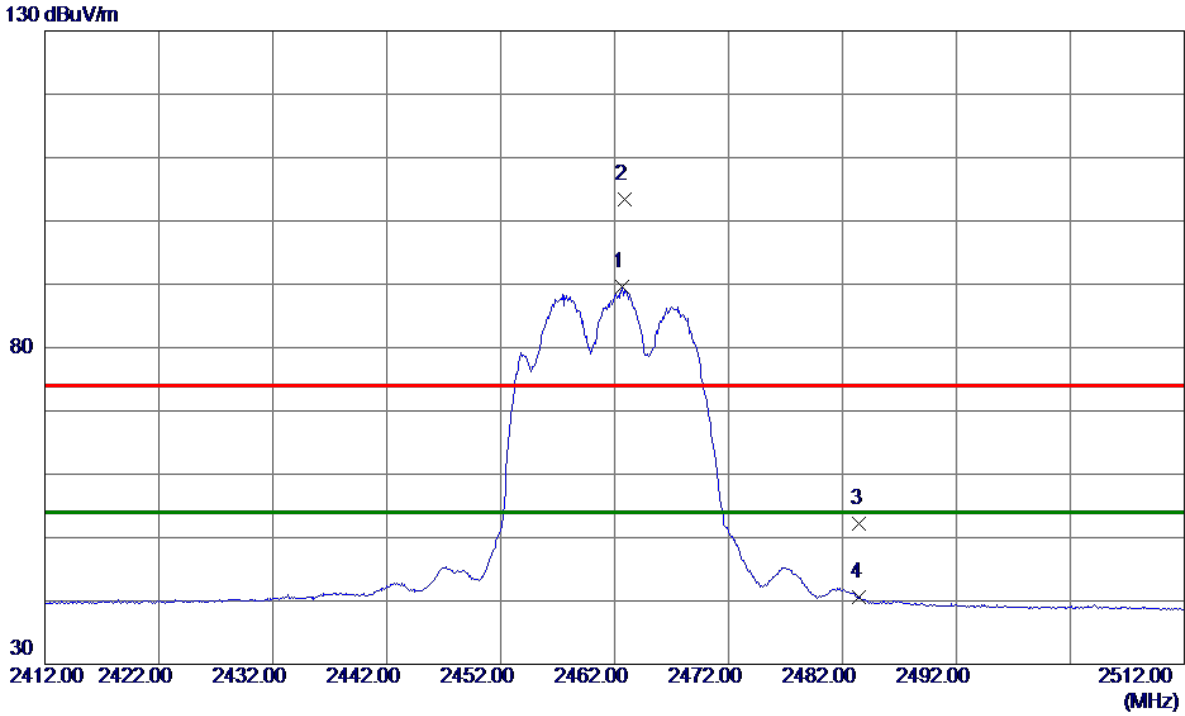

No.	Freq. MHz	Reading Level dBuV/m	Correct Factor dB	Measure ment dBuV/m	Limit dBuV/m	Margin dB	Detector	Comment
1 *	2462.7000	79.38	10.23	89.61	54.00	35.61	AVG	No Limit
2	2462.9000	93.09	10.24	103.33	74.00	29.33	Peak	No Limit
3	2483.5000	41.91	10.29	52.20	74.00	-21.80	Peak	
4	2483.5000	30.27	10.29	40.56	54.00	-13.44	AVG	

Orthogonal Axis :	X
Test Mode :	TX G MODE 2462MHz

Horizontal

80 dBuV/m

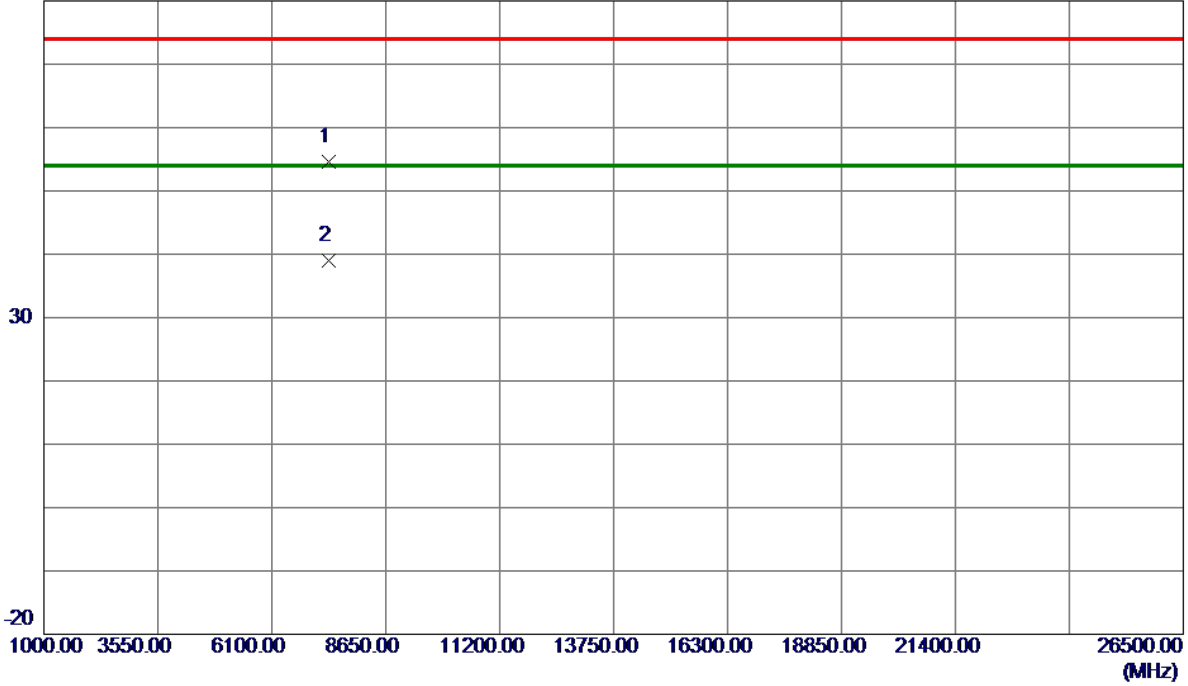

No.	Freq. MHz	Reading Level dBuV/m	Correct Factor dB	Measure ment dBuV/m	Limit dBuV/m	Margin dB	Detector	Comment
1	7380.7500	43.80	10.87	54.67	74.00	-19.33	Peak	
2 *	7385.6500	28.19	10.88	39.07	54.00	-14.93	AVG	

Orthogonal Axis :	X
Test Mode :	TX N-20M MODE 2412MHz

Vertical

130 dBuV/m

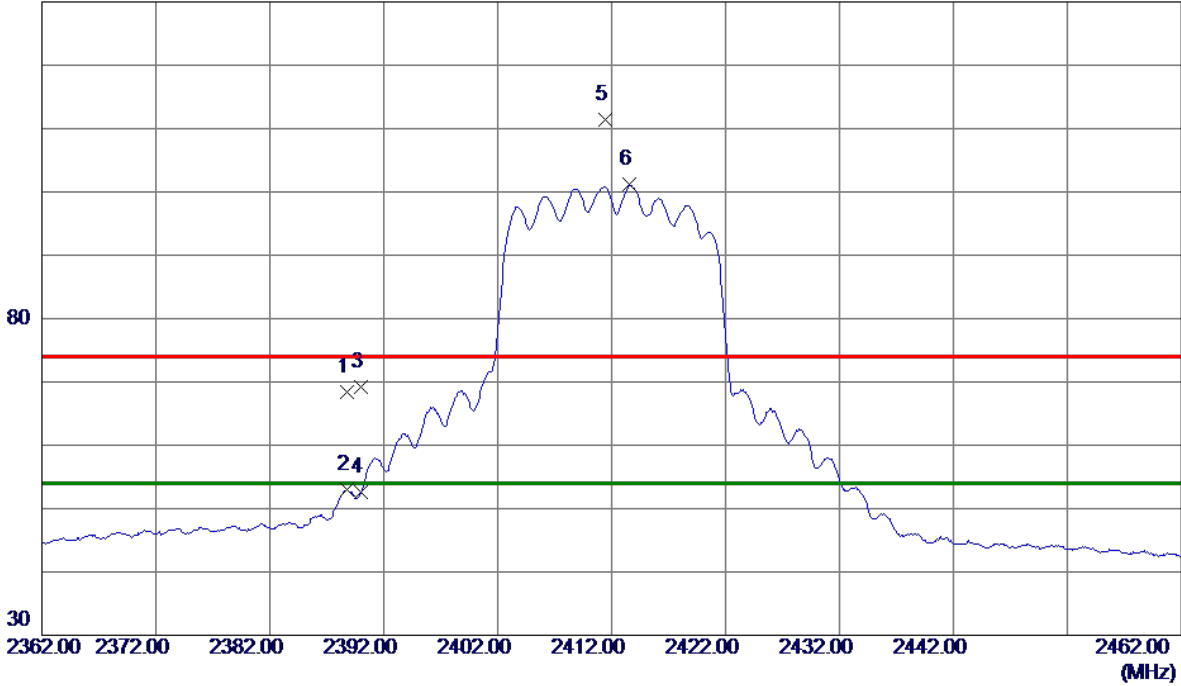

No.	Freq. MHz	Reading Level dBuV/m	Correct Factor dB	Measure ment dBuV/m	Limit dBuV/m	Margin dB	Detector	Comment
1	2388.8000	58.28	10.03	68.31	74.00	-5.69	Peak	
2	2388.8000	42.98	10.03	53.01	54.00	-0.99	AVG	
3	2390.0000	59.16	10.03	69.19	74.00	-4.81	Peak	
4	2390.0000	42.60	10.03	52.63	54.00	-1.37	AVG	
5	2411.4000	101.28	10.09	111.37	74.00	37.37	Peak	No Limit
6 *	2413.6000	91.16	10.10	101.26	54.00	47.26	AVG	No Limit

Orthogonal Axis :	X
Test Mode :	TX N-20M MODE 2412MHz

Vertical

80 dBuV/m

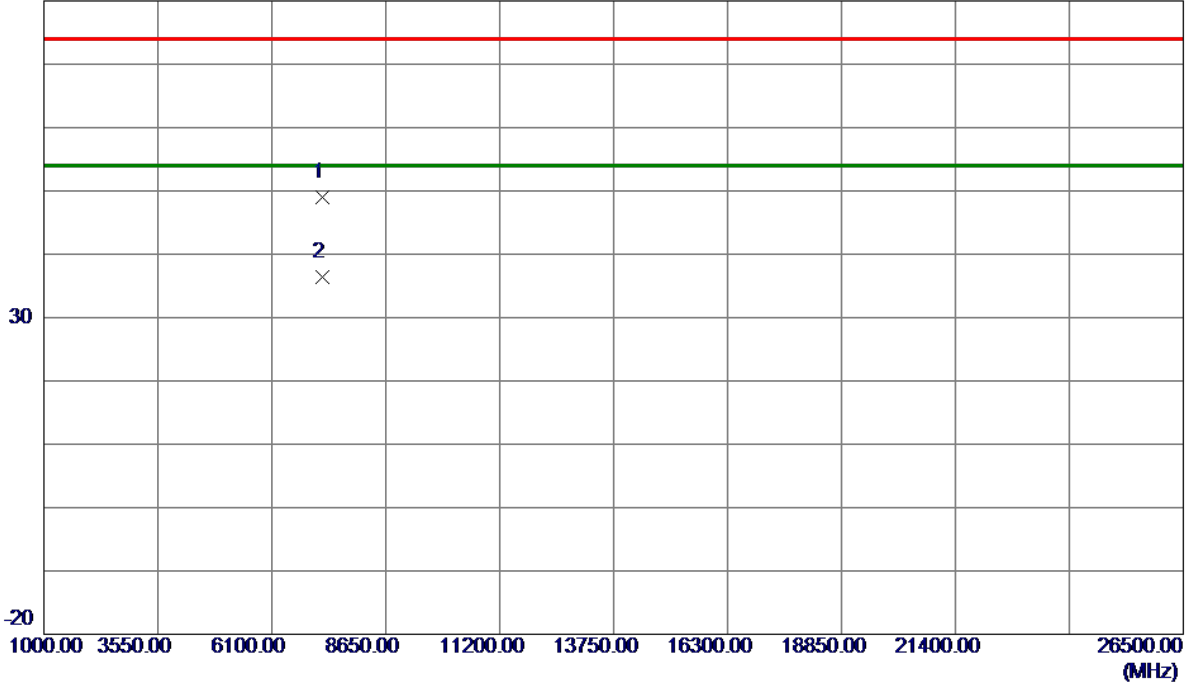

No.	Freq. MHz	Reading Level dBuV/m	Correct Factor dB	Measure ment dBuV/m	Limit dBuV/m	Margin dB	Detector	Comment
1	7235.1000	38.33	10.73	49.06	74.00	-24.94	Peak	
2 *	7235.8000	25.67	10.73	36.40	54.00	-17.60	AVG	

Orthogonal Axis :	X
Test Mode :	TX N-20M MODE 2412MHz

Horizontal

130 dBuV/m

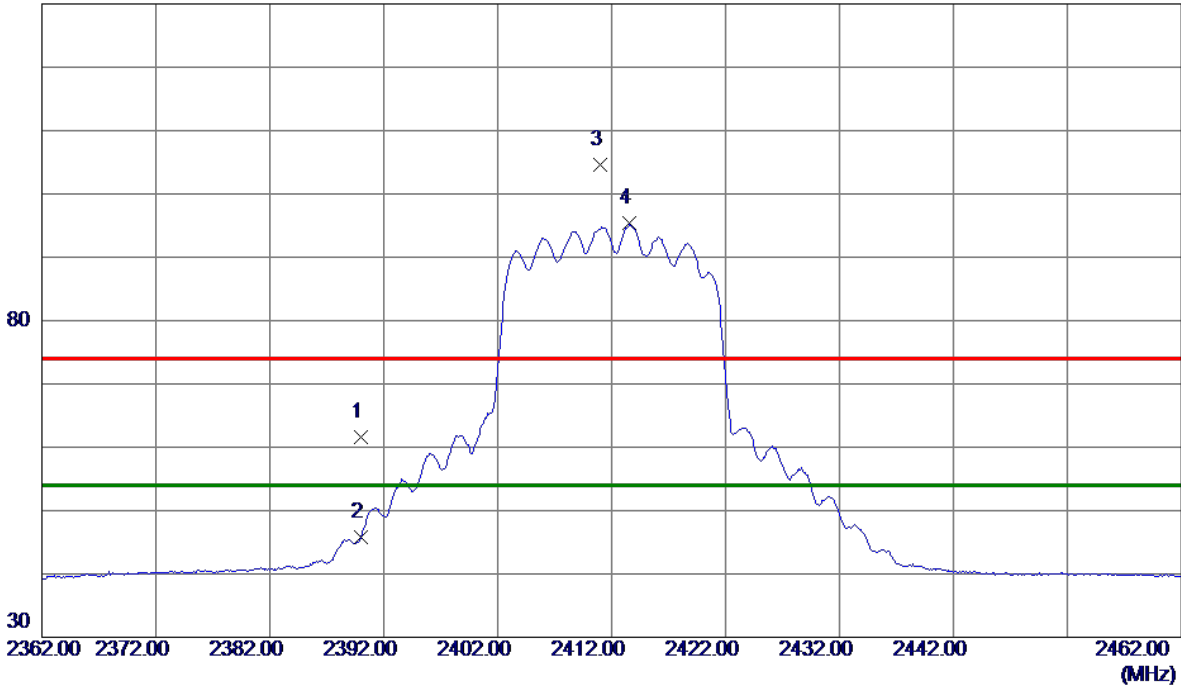

No.	Freq. MHz	Reading Level dBuV/m	Correct Factor dB	Measure ment dBuV/m	Limit dBuV/m	Margin dB	Detector	Comment
1	2390.0000	51.53	10.03	61.56	74.00	-12.44	Peak	
2	2390.0000	35.78	10.03	45.81	54.00	-8.19	AVG	
3	2411.0000	94.52	10.09	104.61	74.00	30.61	Peak	No Limit
4 *	2413.6000	85.23	10.10	95.33	54.00	41.33	AVG	No Limit

Orthogonal Axis :	X
Test Mode :	TX N-20M MODE 2412MHz

Horizontal

80 dBuV/m

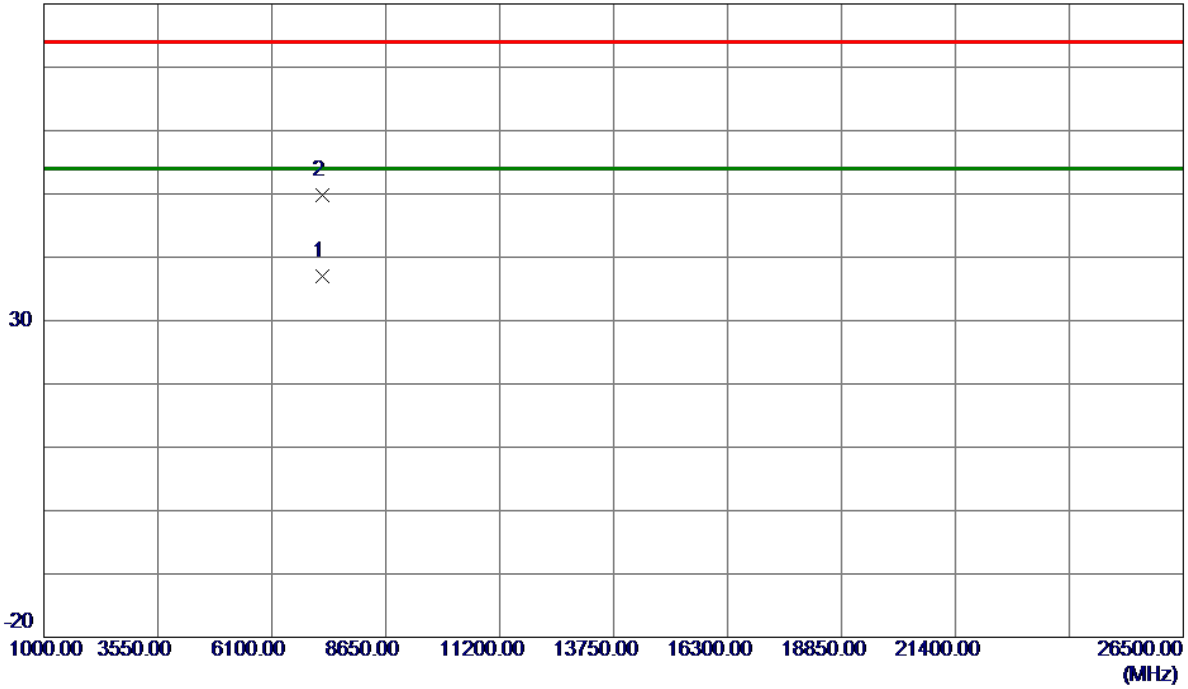

No.	Freq. MHz	Reading Level dBuV/m	Correct Factor dB	Measure ment dBuV/m	Limit dBuV/m	Margin dB	Detector	Comment
1 *	7237.2000	26.31	10.73	37.04	54.00	-16.96	AVG	
2	7239.7000	39.13	10.73	49.86	74.00	-24.14	Peak	

Orthogonal Axis :	X
Test Mode :	TX N-20M MODE 2417MHz

Vertical

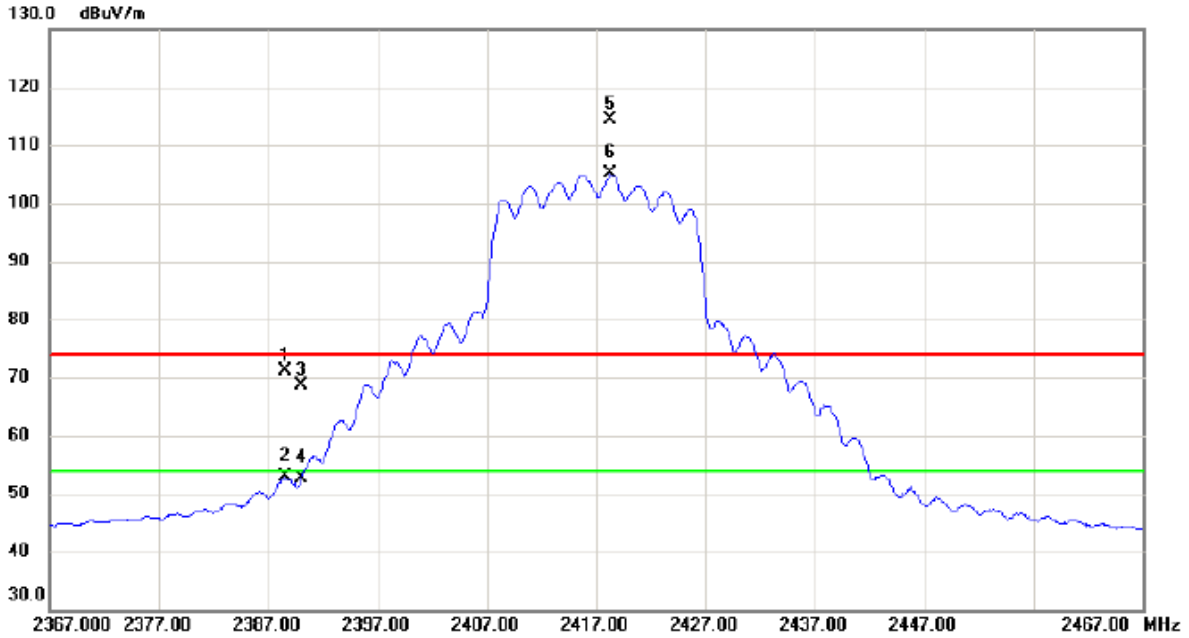

No.	Mk.	Freq. MHz	Reading Level dBuV	Correct Factor dB	Measure- ment dBuV/m	Limit dBuV/m	Margin dB	Detector	Comment
1		2388.500	61.13	10.03	71.16	74.00	-2.84	peak	
2		2388.500	42.75	10.03	52.78	54.00	-1.22	AVG	
3		2390.000	58.58	10.03	68.61	74.00	-5.39	peak	
4		2390.000	42.55	10.03	52.58	54.00	-1.42	AVG	
5	X	2418.300	104.1	10.11	114.30	74.00	40.30	peak	No Limit
6	*	2418.300	94.99	10.11	105.10	54.00	51.10	AVG	No Limit

Orthogonal Axis :	X
Test Mode :	TX N-20M MODE 2417MHz

Vertical

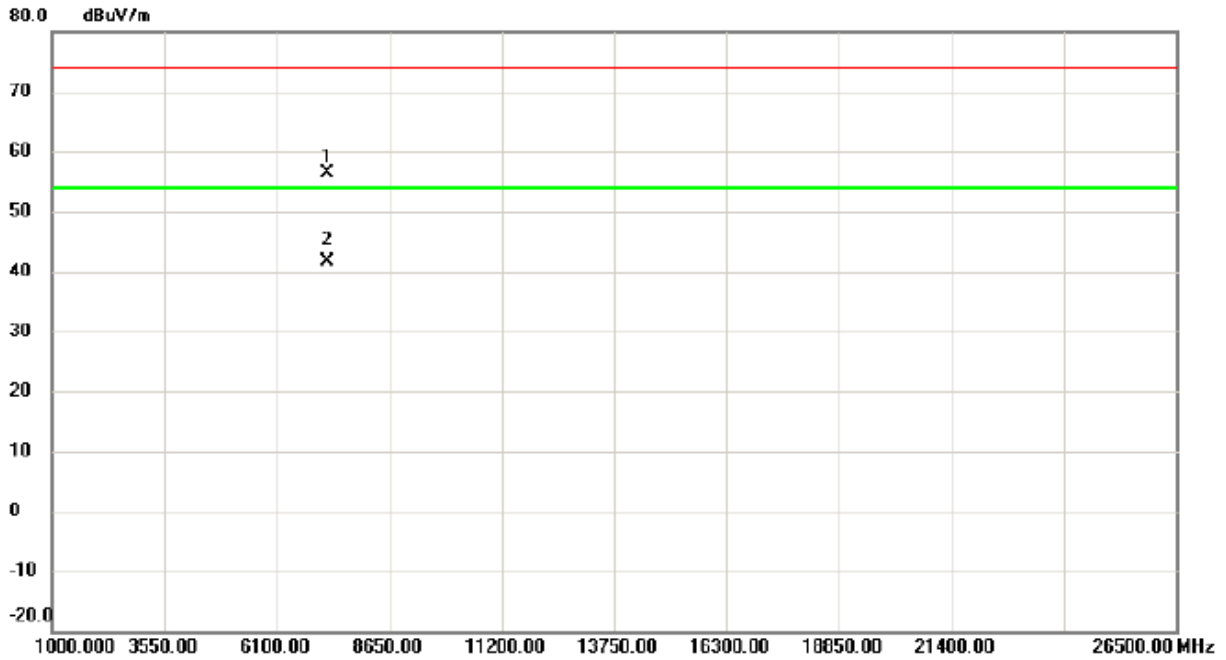

No.	Mk.	Freq. MHz	Reading Level dBuV	Correct Factor dB	Measure- ment dBuV/m	Limit dBuV/m	Margin dB	Detector	Comment
1		7250.250	45.73	10.74	56.47	74.00	-17.53	peak	
2	*	7250.650	30.78	10.74	41.52	54.00	-12.48	AVG	

Orthogonal Axis :	X
Test Mode :	TX N-20M MODE 2417MHz

Horizontal

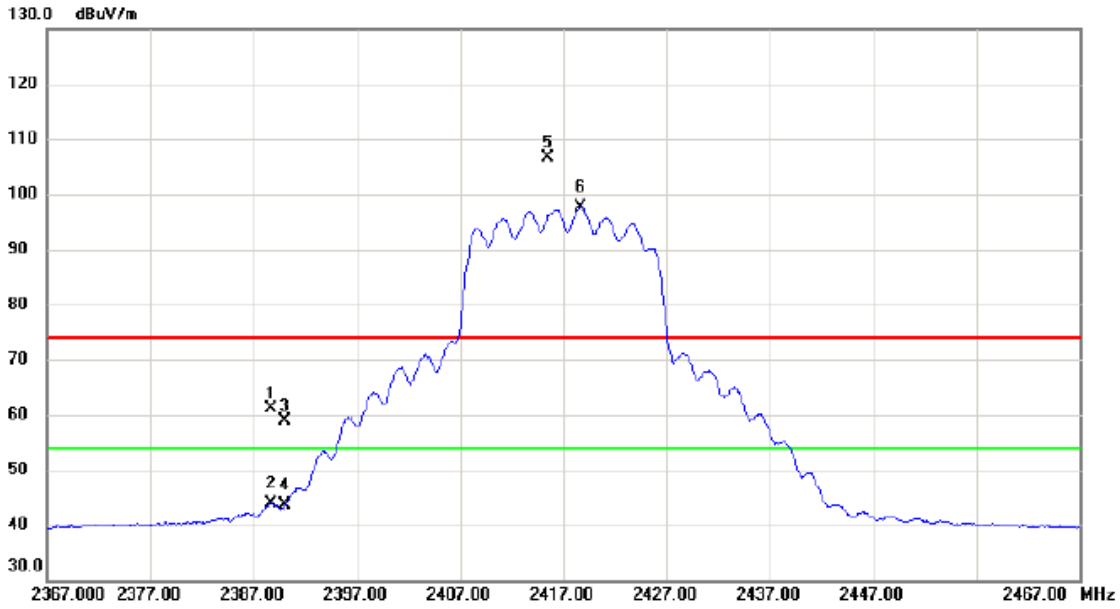

No.	Mk.	Freq. MHz	Reading Level dBuV	Correct Factor dB	Measure- ment dBuV/m	Limit dBuV/m	Margin dB	Detector	Comment
1		2388.700	51.20	10.03	61.23	74.00	-12.77	peak	
2		2388.700	33.95	10.03	43.98	54.00	-10.02	AVG	
3		2390.000	48.83	10.03	58.86	74.00	-15.14	peak	
4		2390.000	33.54	10.03	43.57	54.00	-10.43	AVG	
5	X	2415.400	96.61	10.10	106.71	74.00	32.71	peak	No Limit
6	*	2418.700	87.57	10.11	97.68	54.00	43.68	AVG	No Limit

Orthogonal Axis :	X
Test Mode :	TX N-20M MODE 2417MHz

Horizontal

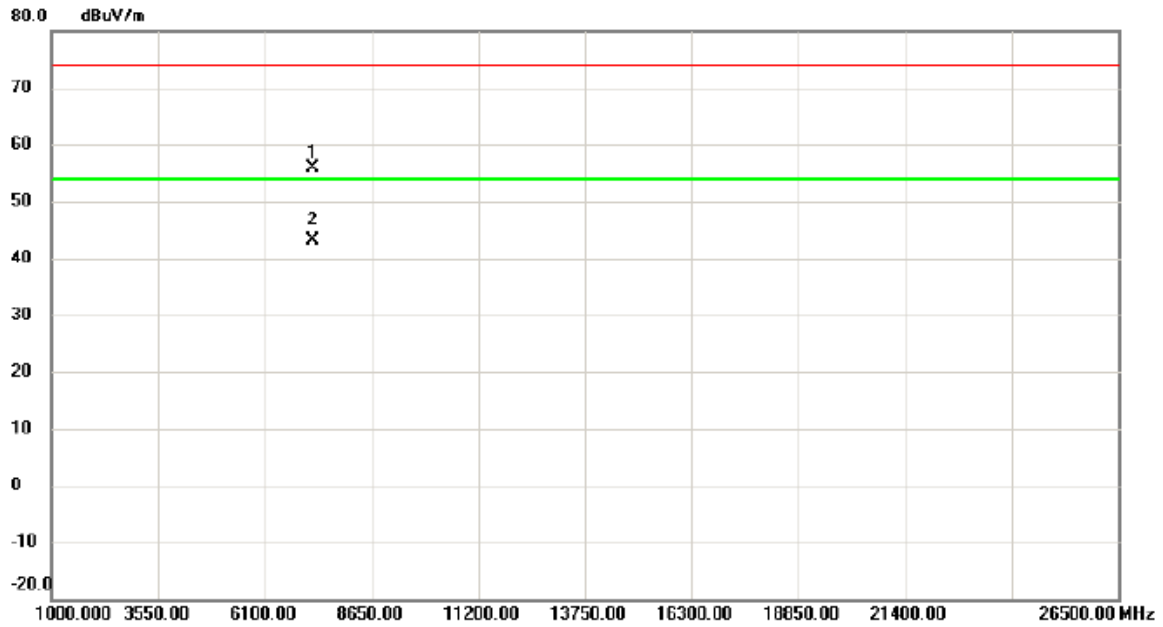

No.	Mk.	Freq. MHz	Reading Level dBuV	Correct Factor dB	Measure- ment dBuV/m	Limit dBuV/m	Margin dB	Detector	Comment
1		7254.800	45.08	10.74	55.82	74.00	-18.18	peak	
2	*	7255.000	32.42	10.74	43.16	54.00	-10.84	AVG	

Orthogonal Axis :	X
Test Mode :	TX N-20M MODE 2437MHz

Vertical

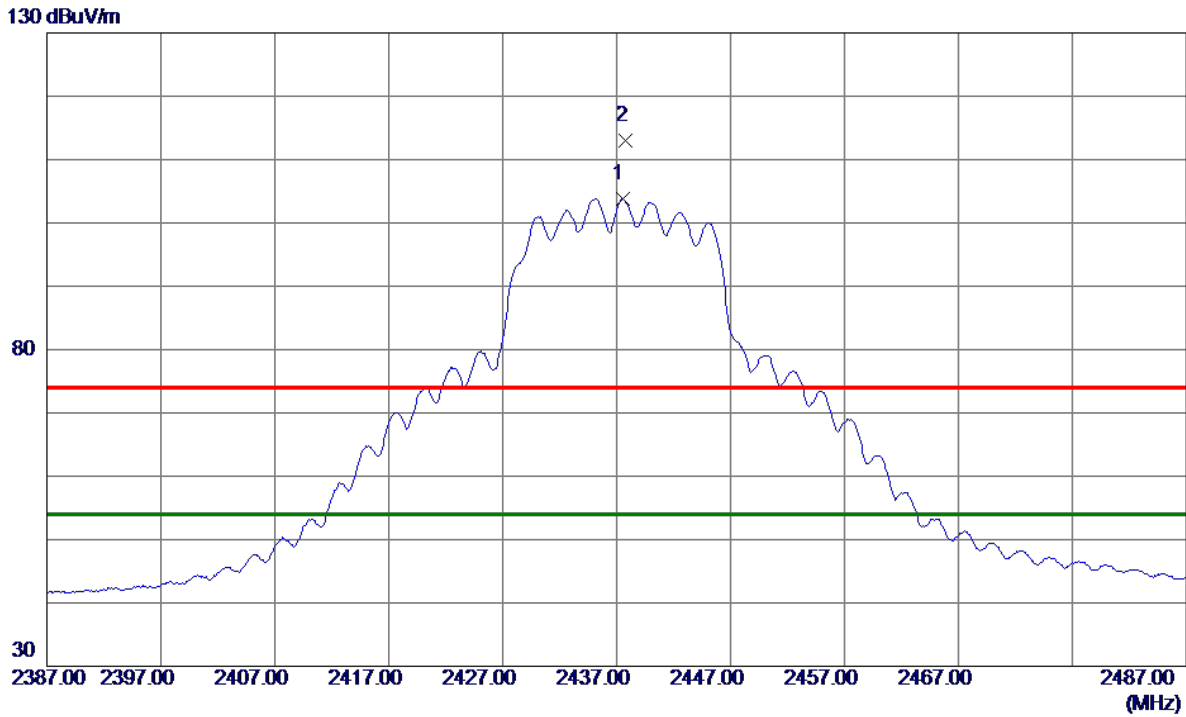

No.	Freq. MHz	Reading Level dBuV/m	Correct Factor dB	Measure ment dBuV/m	Limit dBuV/m	Margin dB	Detector	Comment
1 *	2437.5000	93.73	10.16	103.89	54.00	49.89	AVG	No Limit
2	2437.8000	102.79	10.16	112.95	74.00	38.95	Peak	No Limit

Orthogonal Axis :	X
Test Mode :	TX N-20M MODE 2437MHz

Vertical

80 dBuV/m

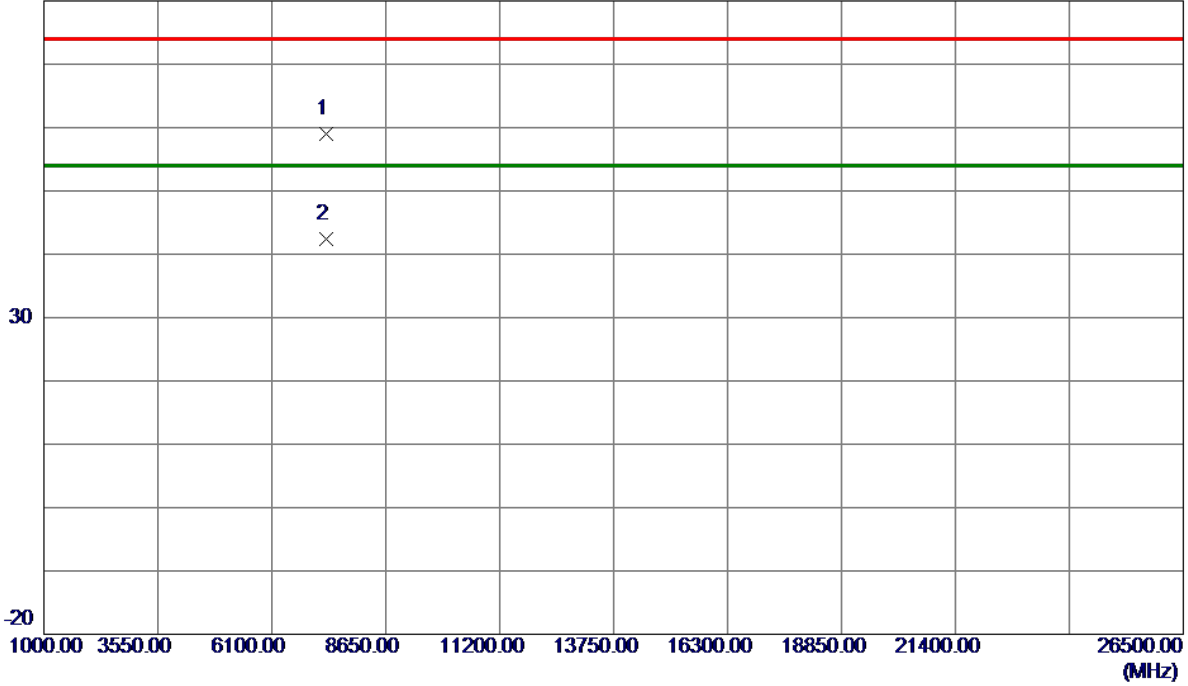

No.	Freq. MHz	Reading Level dBuV/m	Correct Factor dB	Measure ment dBuV/m	Limit dBuV/m	Margin dB	Detector	Comment
1	7310.8500	48.16	10.80	58.96	74.00	-15.04	Peak	
2 *	7310.9000	31.58	10.80	42.38	54.00	-11.62	AVG	

Orthogonal Axis :	X
Test Mode :	TX N-20M MODE 2437MHz

Horizontal

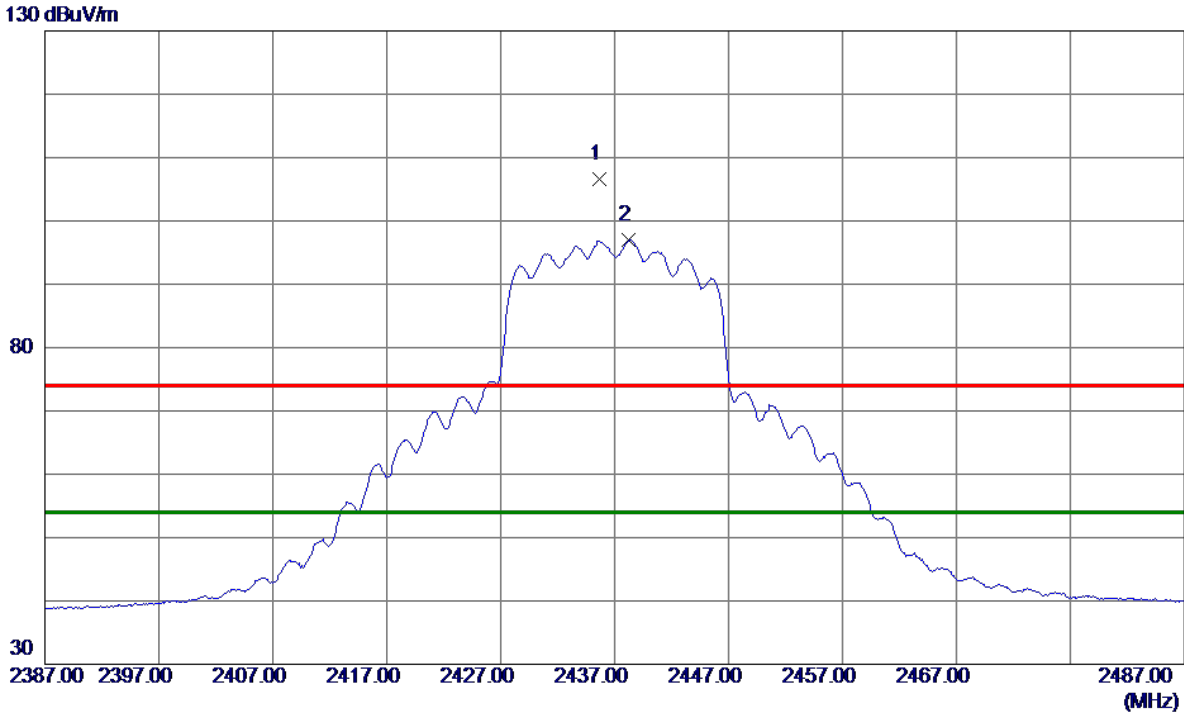

No.	Freq. MHz	Reading Level dBuV/m	Correct Factor dB	Measure ment dBuV/m	Limit dBuV/m	Margin dB	Detector	Comment
1	2435.7000	96.36	10.16	106.52	74.00	32.52	Peak	No Limit
2 *	2438.2000	86.84	10.17	97.01	54.00	43.01	AVG	No Limit

Orthogonal Axis :	X
Test Mode :	TX N-20M MODE 2437MHz

Horizontal

80 dBuV/m

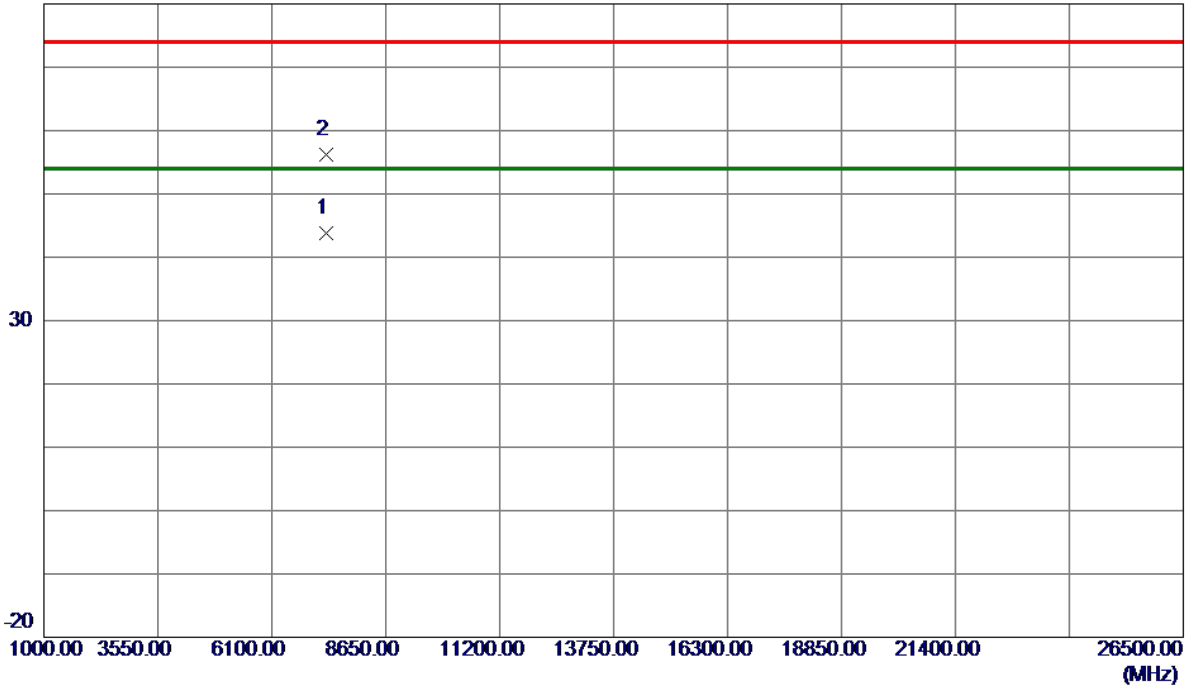

No.	Freq. MHz	Reading Level dBuV/m	Correct Factor dB	Measure ment dBuV/m	Limit dBuV/m	Margin dB	Detector	Comment
1 *	7310.0000	33.06	10.80	43.86	54.00	-10.14	AVG	
2	7317.2000	45.39	10.81	56.20	74.00	-17.80	Peak	

Orthogonal Axis :	X
Test Mode :	TX N-20M MODE 2457MHz

Vertical

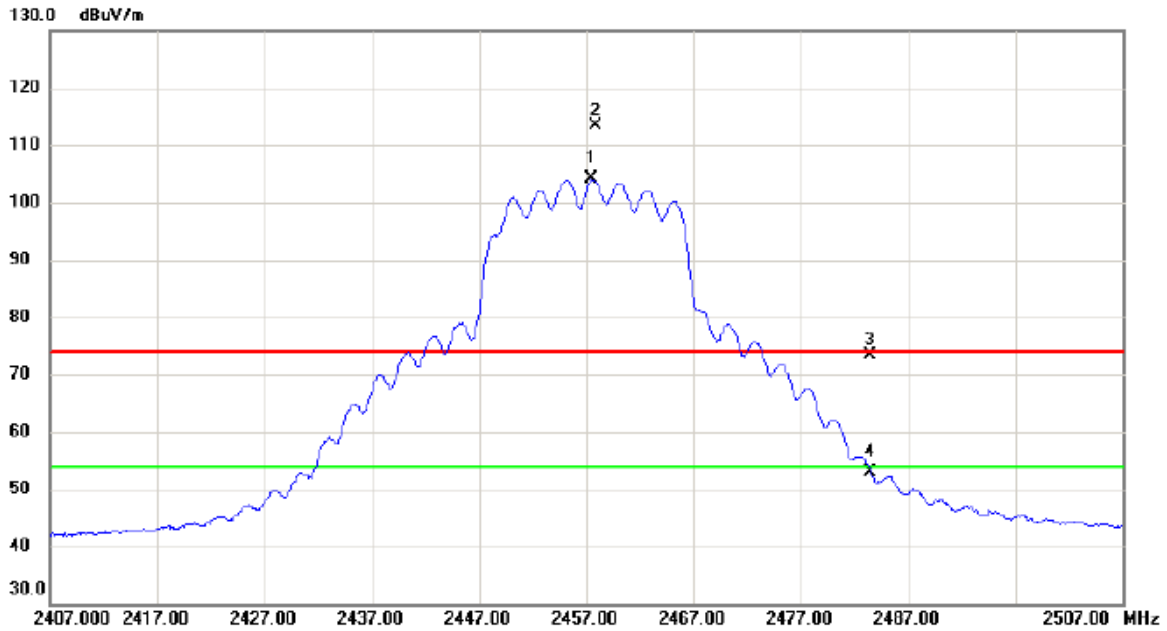

No.	Mk.	Freq. MHz	Reading Level dBuV	Correct Factor dB	Measure- ment dBuV/m	Limit dBuV/m	Margin dB	Detector	Comment
1	*	2457.500	93.85	10.22	104.07	54.00	50.07	AVG	No Limit
2	X	2457.900	103.0	10.22	113.28	74.00	39.28	peak	No Limit
3		2483.500	63.19	10.29	73.48	74.00	-0.52	peak	
4		2483.500	42.65	10.29	52.94	54.00	-1.06	AVG	

Orthogonal Axis :	X
Test Mode :	TX N-20M MODE 2457MHz

Vertical

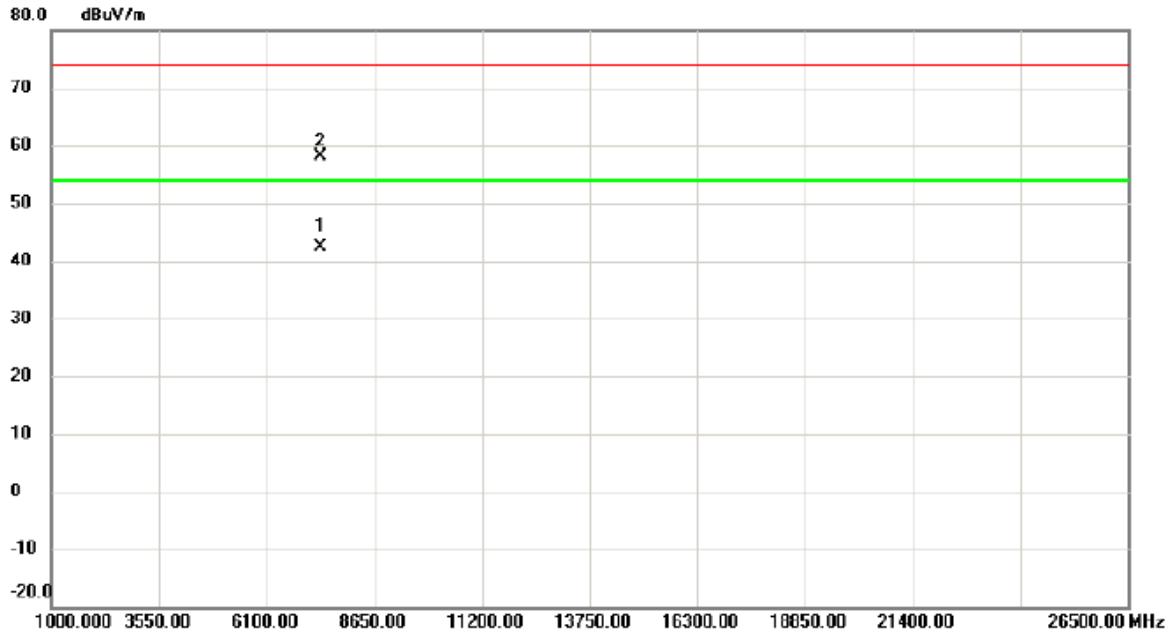

No.	Mk.	Freq. MHz	Reading Level dBuV	Correct Factor dB	Measure- ment dBuV/m	Limit dBuV/m	Margin dB	Detector	Comment
1	*	7371.450	31.55	10.86	42.41	54.00	-11.59	AVG	
2		7374.000	47.30	10.86	58.16	74.00	-15.84	peak	

Orthogonal Axis :	X
Test Mode :	TX N-20M MODE 2457MHz

Horizontal

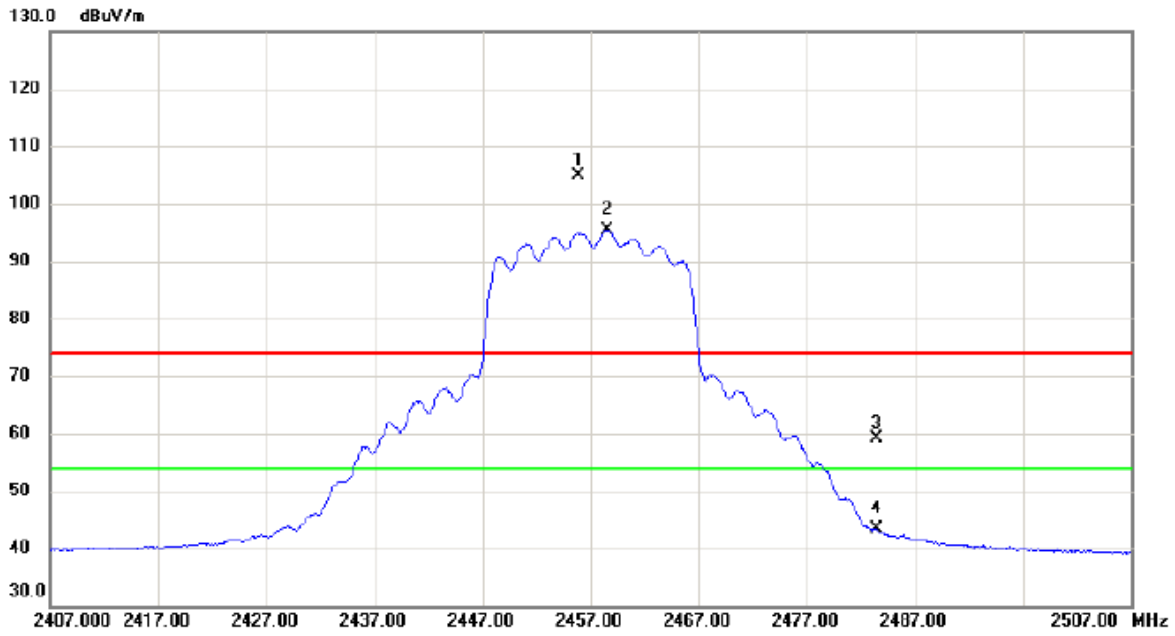

No.	Mk.	Freq. MHz	Reading Level dBuV	Correct Factor dB	Measure- ment dBuV/m	Limit dBuV/m	Margin dB	Detector	Comment
1	X	2455.900	94.63	10.22	104.85	74.00	30.85	peak	No Limit
2	*	2458.500	85.23	10.23	95.46	54.00	41.46	AVG	No Limit
3		2483.500	48.79	10.29	59.08	74.00	-14.92	peak	
4		2483.500	32.97	10.29	43.26	54.00	-10.74	AVG	

Orthogonal Axis :	X
Test Mode :	TX N-20M MODE 2457MHz

Horizontal

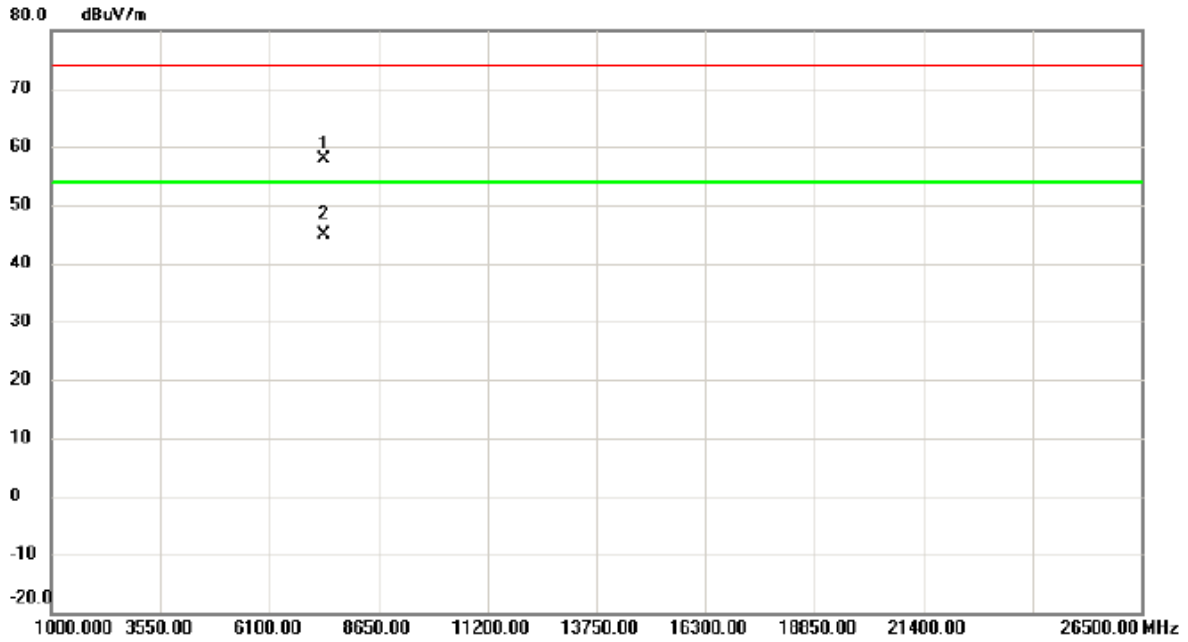

No.	Mk.	Freq. MHz	Reading Level dBuV	Correct Factor dB	Measure- ment dBuV/m	Limit dBuV/m	Margin dB	Detector	Comment
1		7367.800	47.05	10.86	57.91	74.00	-16.09	peak	
2	*	7370.500	34.12	10.86	44.98	54.00	-9.02	AVG	

Orthogonal Axis :	X
Test Mode :	TX N-20M MODE 2462MHz

Vertical

130 dBuV/m

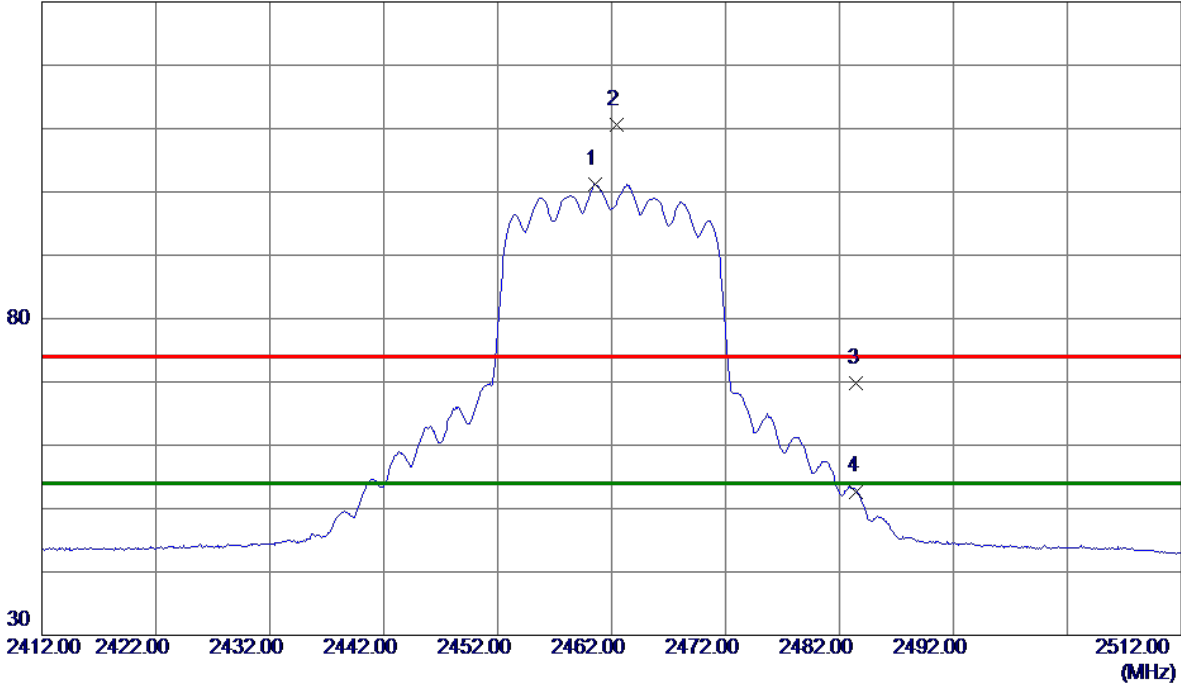

No.	Freq. MHz	Reading Level dBuV/m	Correct Factor dB	Measure ment dBuV/m	Limit dBuV/m	Margin dB	Detector	Comment
1 *	2460.6000	90.93	10.23	101.16	54.00	47.16	AVG	No Limit
2	2462.4000	100.46	10.23	110.69	74.00	36.69	Peak	No Limit
3	2483.5000	59.45	10.29	69.74	74.00	-4.26	Peak	
4	2483.5000	42.41	10.29	52.70	54.00	-1.30	AVG	

Orthogonal Axis :	X
Test Mode :	TX N-20M MODE 2462MHz

Vertical

80 dBuV/m

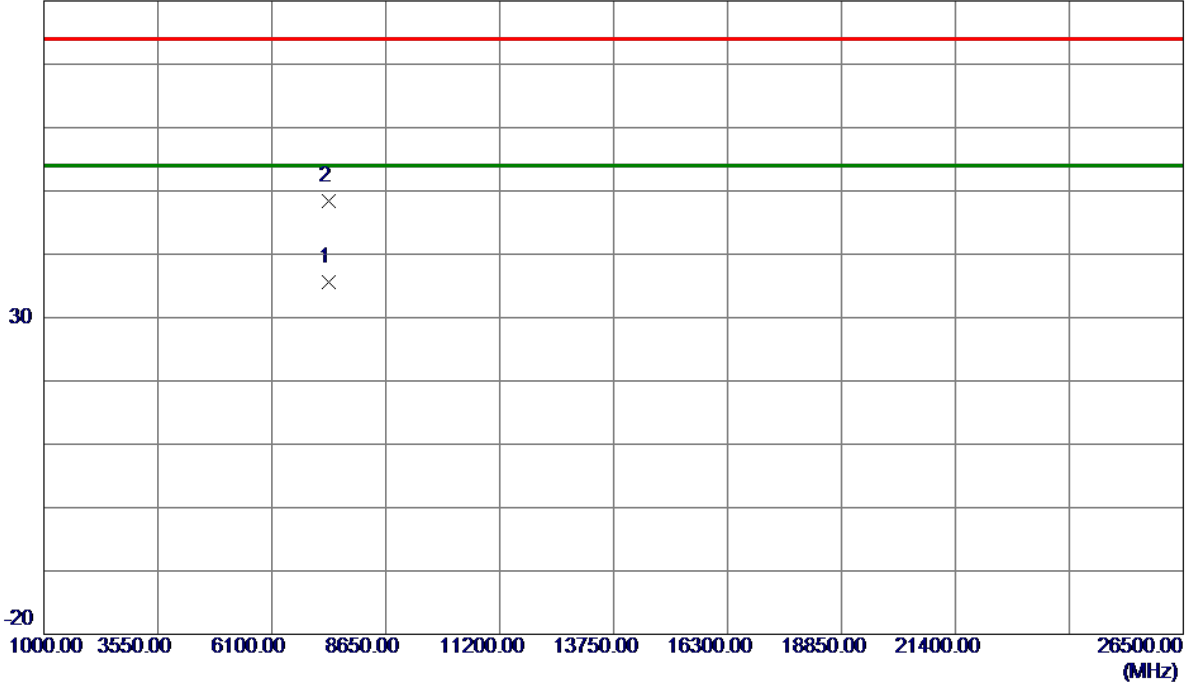

No.	Freq. MHz	Reading Level dBuV/m	Correct Factor dB	Measure ment dBuV/m	Limit dBuV/m	Margin dB	Detector	Comment
1 *	7386.5000	24.73	10.88	35.61	54.00	-18.39	AVG	
2	7389.0000	37.54	10.88	48.42	74.00	-25.58	Peak	

Orthogonal Axis :	X
Test Mode :	TX N-20M MODE 2462MHz

Horizontal

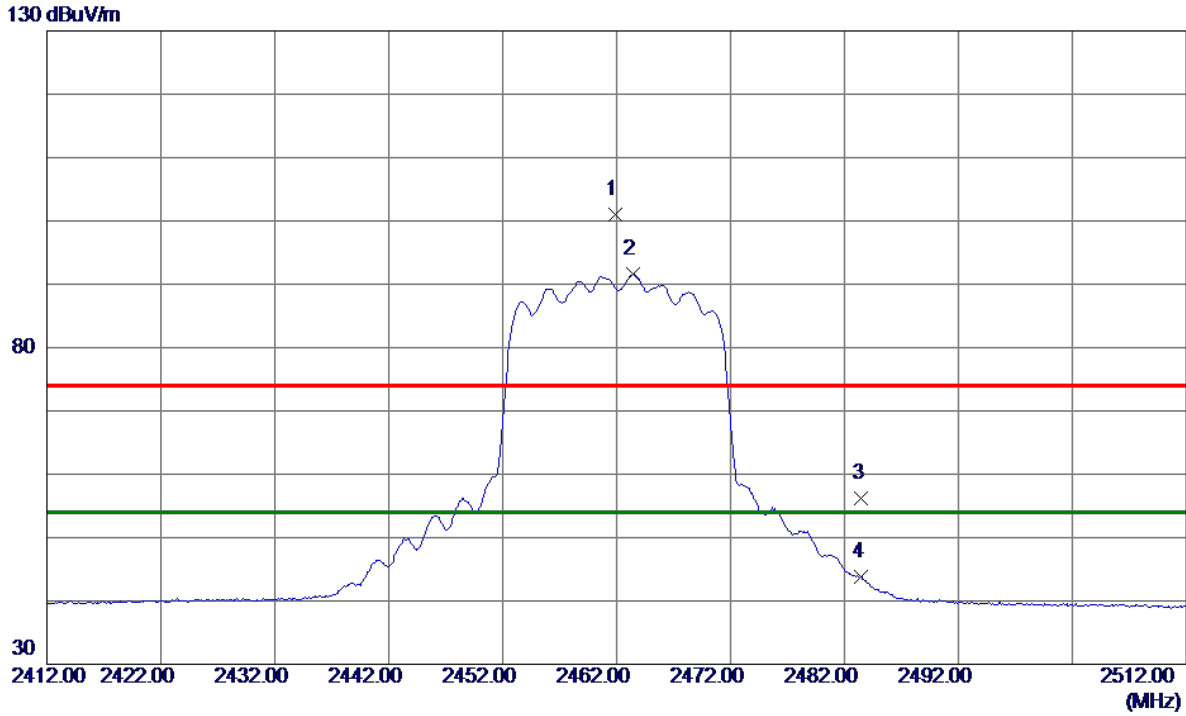

No.	Freq. MHz	Reading Level dBuV/m	Correct Factor dB	Measure ment dBuV/m	Limit dBuV/m	Margin dB	Detector	Comment
1	2461.9000	90.76	10.23	100.99	74.00	26.99	Peak	No Limit
2 *	2463.4000	81.44	10.24	91.68	54.00	37.68	AVG	No Limit
3	2483.5000	45.87	10.29	56.16	74.00	-17.84	Peak	
4	2483.5000	33.48	10.29	43.77	54.00	-10.23	AVG	

Orthogonal Axis :	X
Test Mode :	TX N-20M MODE 2462MHz

Horizontal

80 dBuV/m

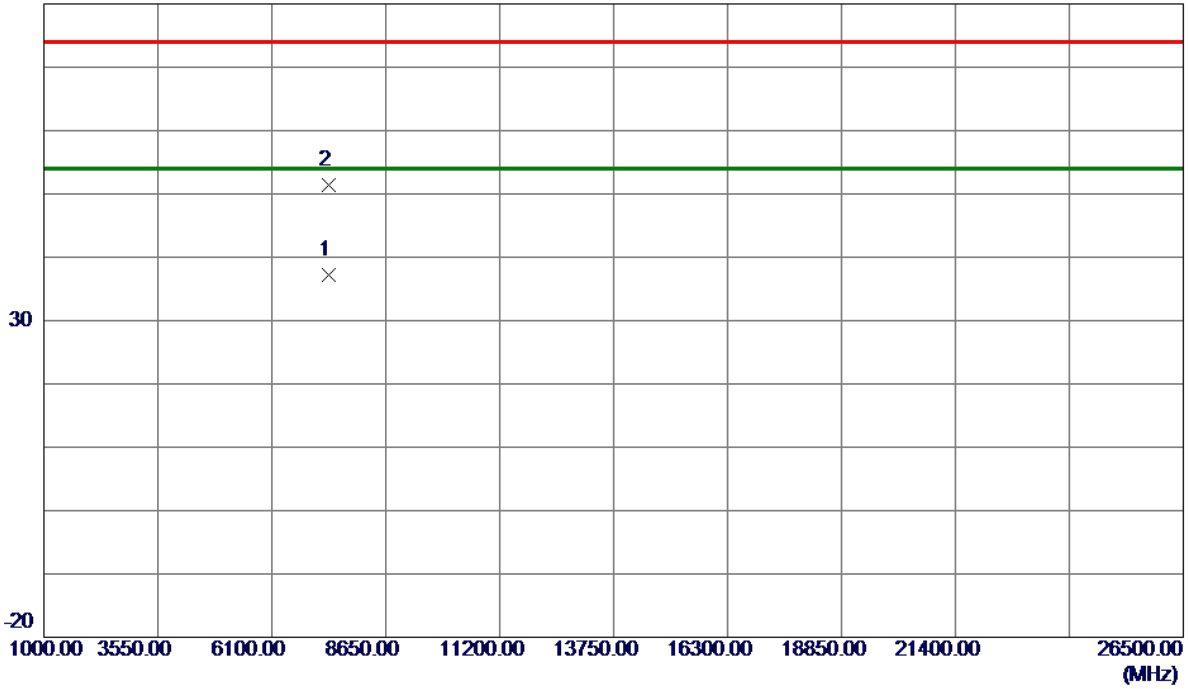

No.	Freq. MHz	Reading Level dBuV/m	Correct Factor dB	Measure ment dBuV/m	Limit dBuV/m	Margin dB	Detector	Comment
1 *	7385.4000	26.39	10.88	37.27	54.00	-16.73	AVG	
2	7387.7000	40.50	10.88	51.38	74.00	-22.62	Peak	

Orthogonal Axis :	X
Test Mode :	TX N-40M MODE 2422MHz

Vertical

130 dBuV/m

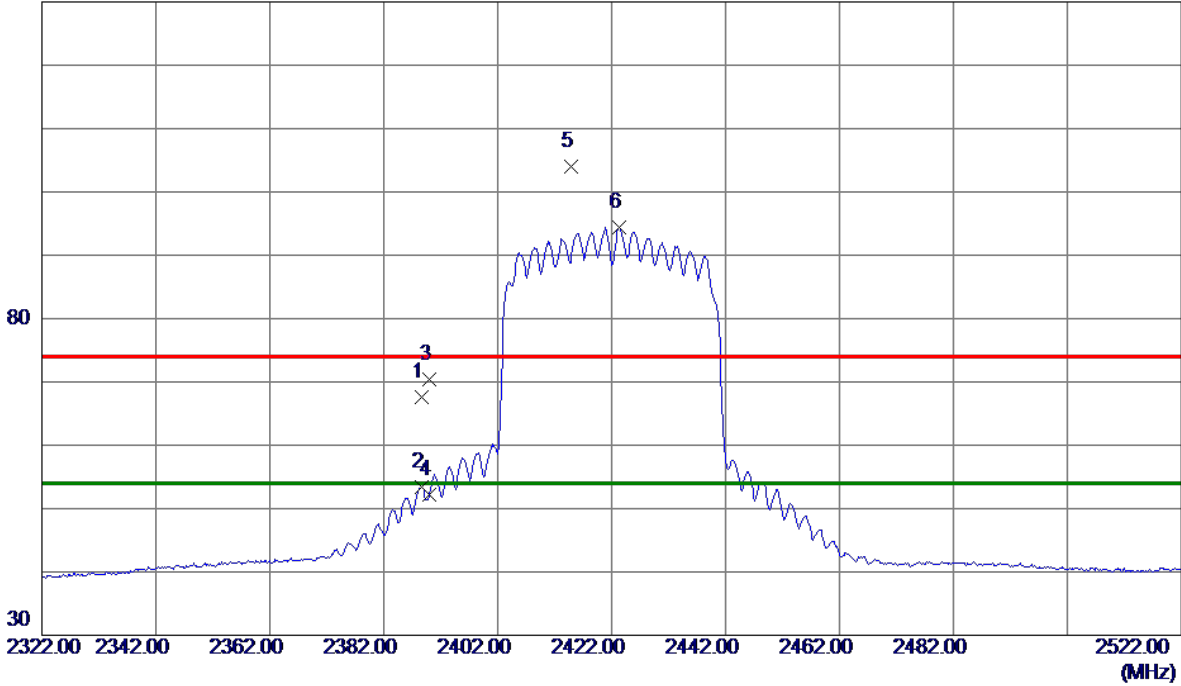

No.	Freq. MHz	Reading Level dBuV/m	Correct Factor dB	Measure ment dBuV/m	Limit dBuV/m	Margin dB	Detector	Comment
1	2388.6000	57.58	10.03	67.61	74.00	-6.39	Peak	
2	2388.6000	43.37	10.03	53.40	54.00	-0.60	AVG	
3	2390.0000	60.28	10.03	70.31	74.00	-3.69	Peak	
4	2390.0000	42.22	10.03	52.25	54.00	-1.75	AVG	
5	2414.8000	93.93	10.10	104.03	74.00	30.03	Peak	No Limit
6 *	2423.4000	84.23	10.12	94.35	54.00	40.35	AVG	No Limit

Orthogonal Axis :	X
Test Mode :	TX N-40M MODE 2422MHz

Vertical

80 dBuV/m

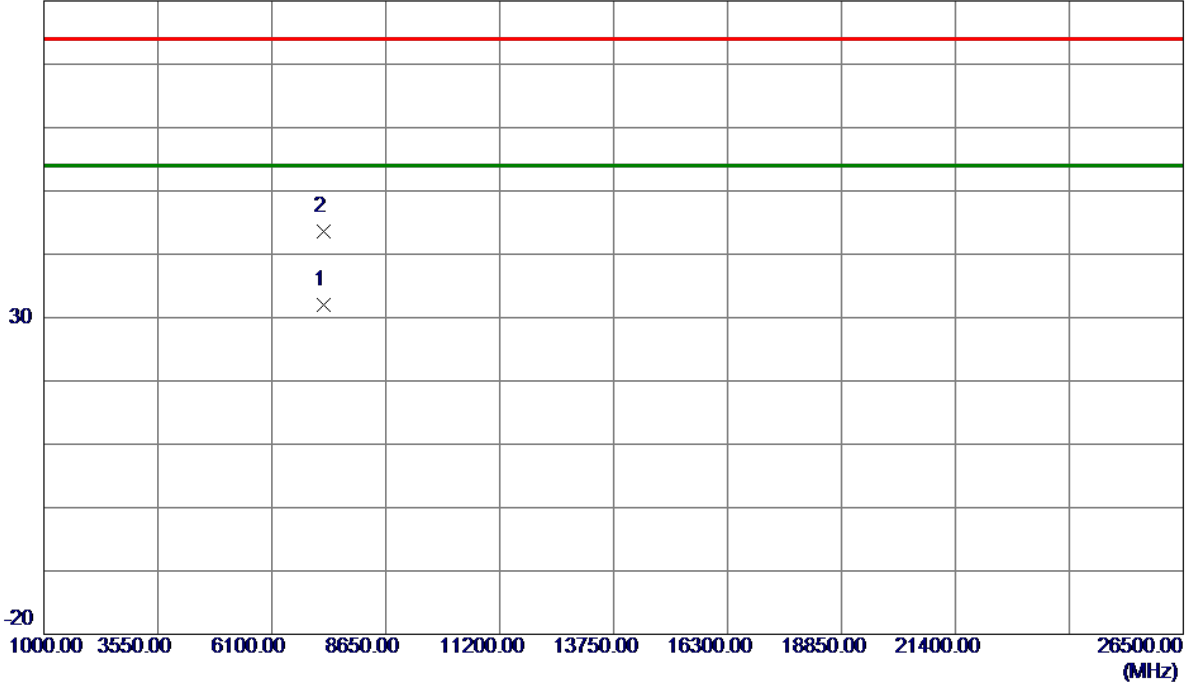

No.	Freq. MHz	Reading Level dBuV/m	Correct Factor dB	Measure ment dBuV/m	Limit dBuV/m	Margin dB	Detector	Comment
1 *	7268.0000	21.23	10.76	31.99	54.00	-22.01	AVG	
2	7268.5000	32.78	10.76	43.54	74.00	-30.46	Peak	

Orthogonal Axis :	X
Test Mode :	TX N-40M MODE 2422MHz

Horizontal

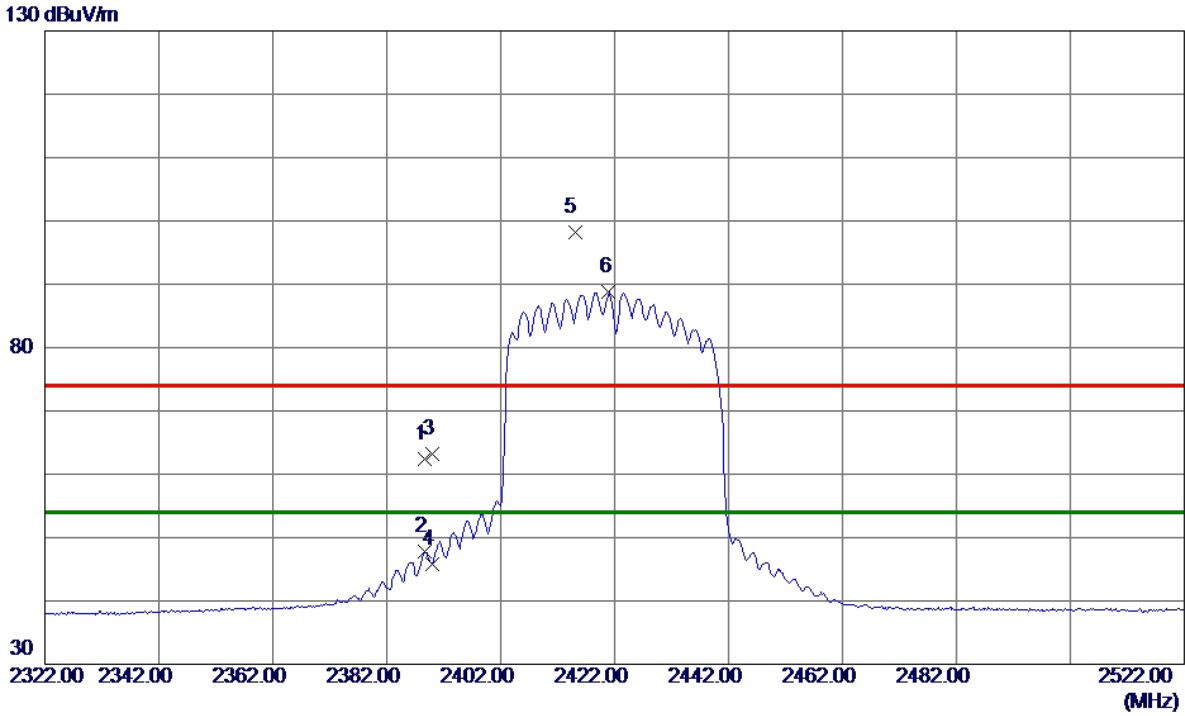

No.	Freq. MHz	Reading Level dBuV/m	Correct Factor dB	Measure ment dBuV/m	Limit dBuV/m	Margin dB	Detector	Comment
1	2388.6000	52.30	10.03	62.33	74.00	-11.67	Peak	
2	2388.6000	37.70	10.03	47.73	54.00	-6.27	AVG	
3	2390.0000	53.20	10.03	63.23	74.00	-10.77	Peak	
4	2390.0000	35.70	10.03	45.73	54.00	-8.27	AVG	
5	2415.0000	88.04	10.10	98.14	74.00	24.14	Peak	No Limit
6 *	2421.0000	78.64	10.12	88.76	54.00	34.76	AVG	No Limit

Orthogonal Axis :	X
Test Mode :	TX N-40M MODE 2422MHz

Horizontal

80 dBuV/m

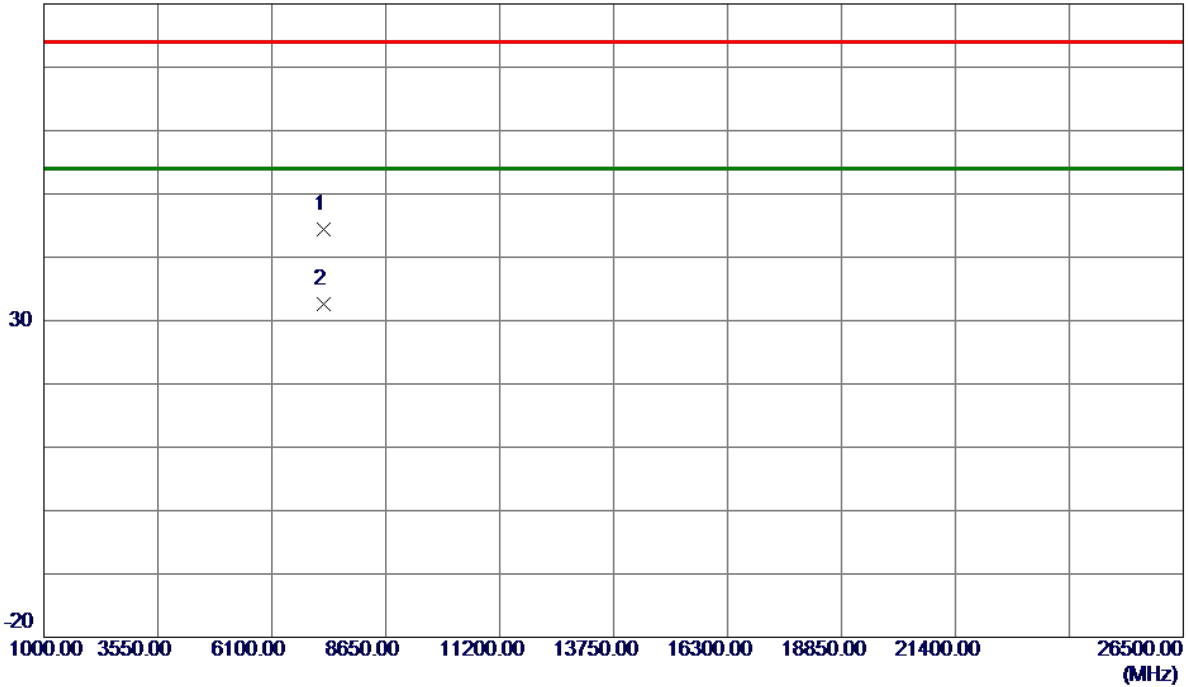

No.	Freq. MHz	Reading Level dBuV/m	Correct Factor dB	Measure ment dBuV/m	Limit dBuV/m	Margin dB	Detector	Comment
1	7270.9000	33.57	10.77	44.34	74.00	-29.66	Peak	
2 *	7273.4000	21.89	10.77	32.66	54.00	-21.34	AVG	

Orthogonal Axis :	X
Test Mode :	TX N-40M MODE 2427MHz

Vertical

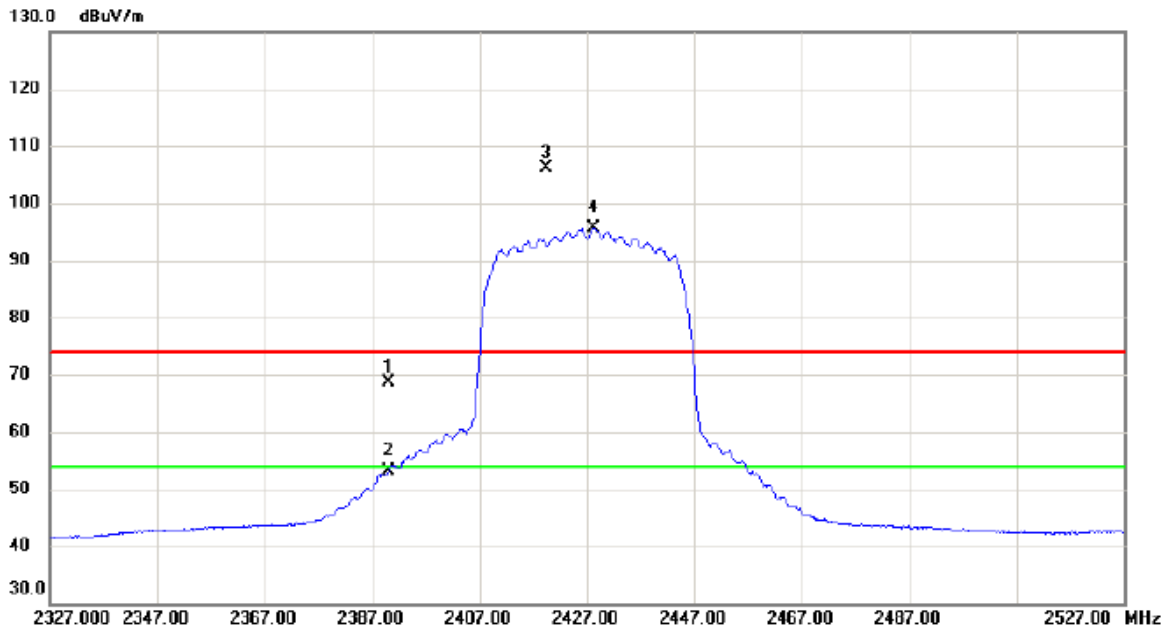

No.	Mk.	Freq. MHz	Reading Level dBuV	Correct Factor dB	Measure- ment dBuV/m	Limit dBuV/m	Margin dB	Detector	Comment
1		2390.000	58.52	10.03	68.55	74.00	-5.45	peak	
2		2390.000	43.06	10.03	53.09	54.00	-0.91	AVG	
3	X	2419.400	96.00	10.11	106.11	74.00	32.11	peak	No Limit
4	*	2428.200	85.56	10.14	95.70	54.00	41.70	AVG	No Limit

Orthogonal Axis :	X
Test Mode :	TX N-40M MODE 2427MHz

Vertical

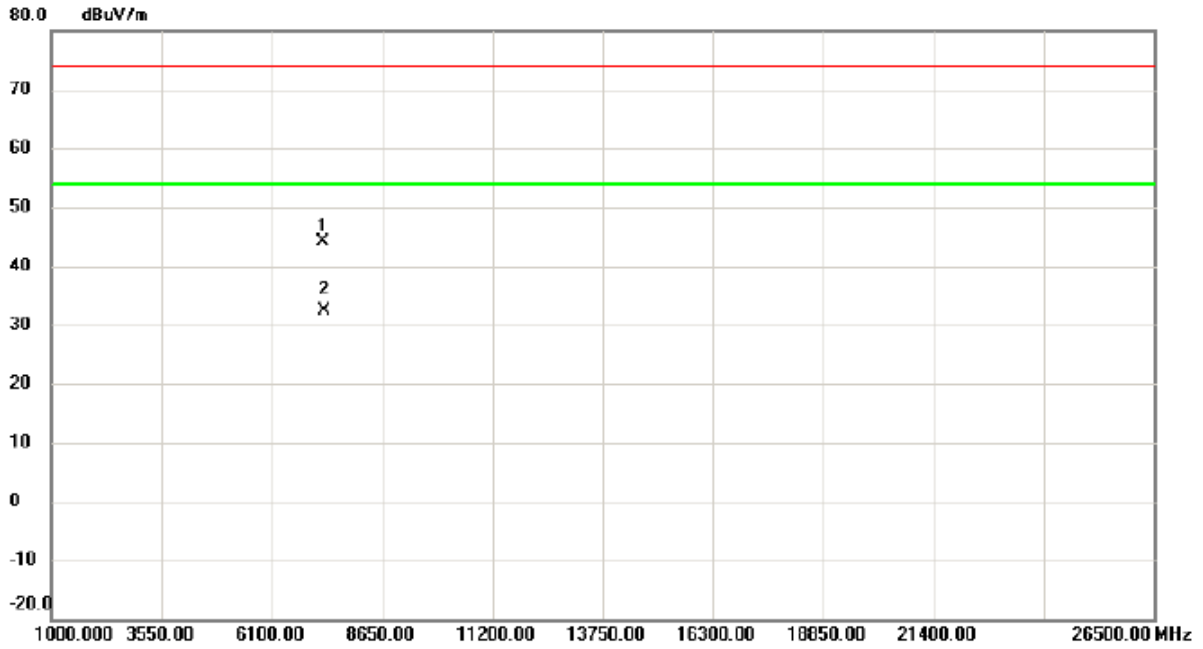

No. Mk.	Freq. MHz	Reading Level dBuV	Correct Factor dB	Measure- ment dBuV/m	Limit dBuV/m	Margin dB	Detector	Comment
1	7266.850	33.46	10.76	44.22	74.00	-29.78	peak	
2 *	7291.200	21.67	10.79	32.46	54.00	-21.54	AVG	

Orthogonal Axis :	X
Test Mode :	TX N-40M MODE 2427MHz

Horizontal

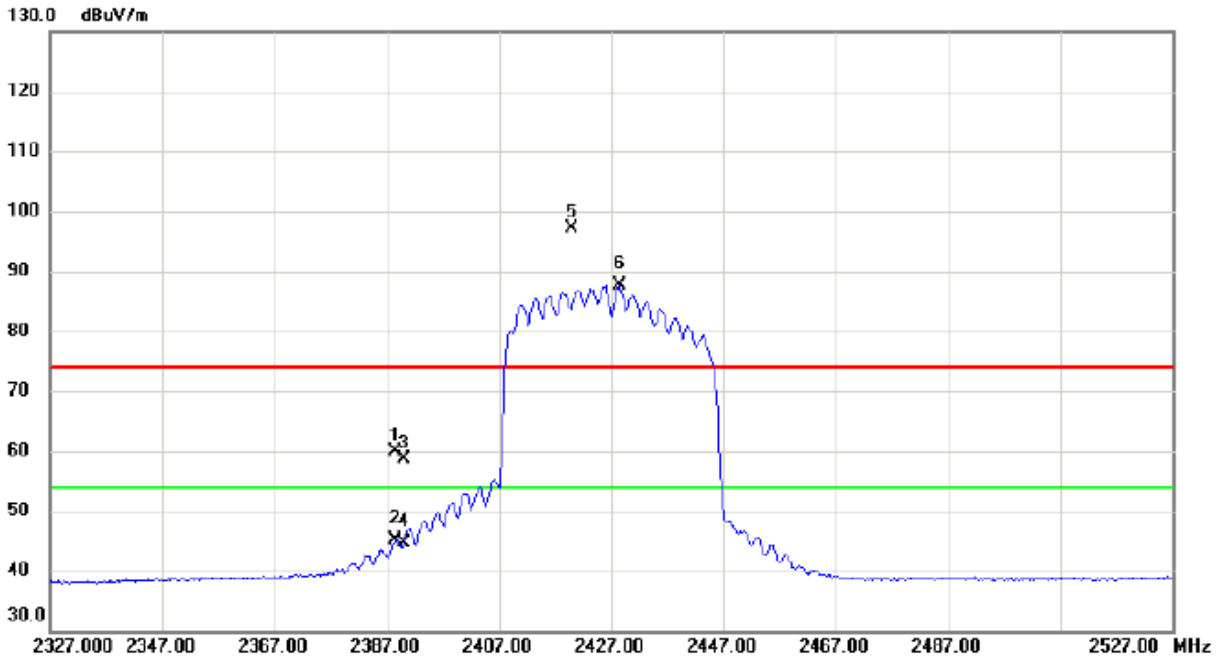

No.	Mk.	Freq. MHz	Reading Level dBuV	Correct Factor dB	Measure- ment dBuV/m	Limit dBuV/m	Margin dB	Detector	Comment
1		2388.600	49.83	10.03	59.86	74.00	-14.14	peak	
2		2388.600	35.10	10.03	45.13	54.00	-8.87	AVG	
3		2390.000	48.53	10.03	58.56	74.00	-15.44	peak	
4		2390.000	34.59	10.03	44.62	54.00	-9.38	AVG	
5	X	2419.800	87.10	10.12	97.22	74.00	23.22	peak	No Limit
6	*	2428.400	77.50	10.14	87.64	54.00	33.64	AVG	No Limit

Orthogonal Axis :	X
Test Mode :	TX N-40M MODE 2427MHz

Horizontal

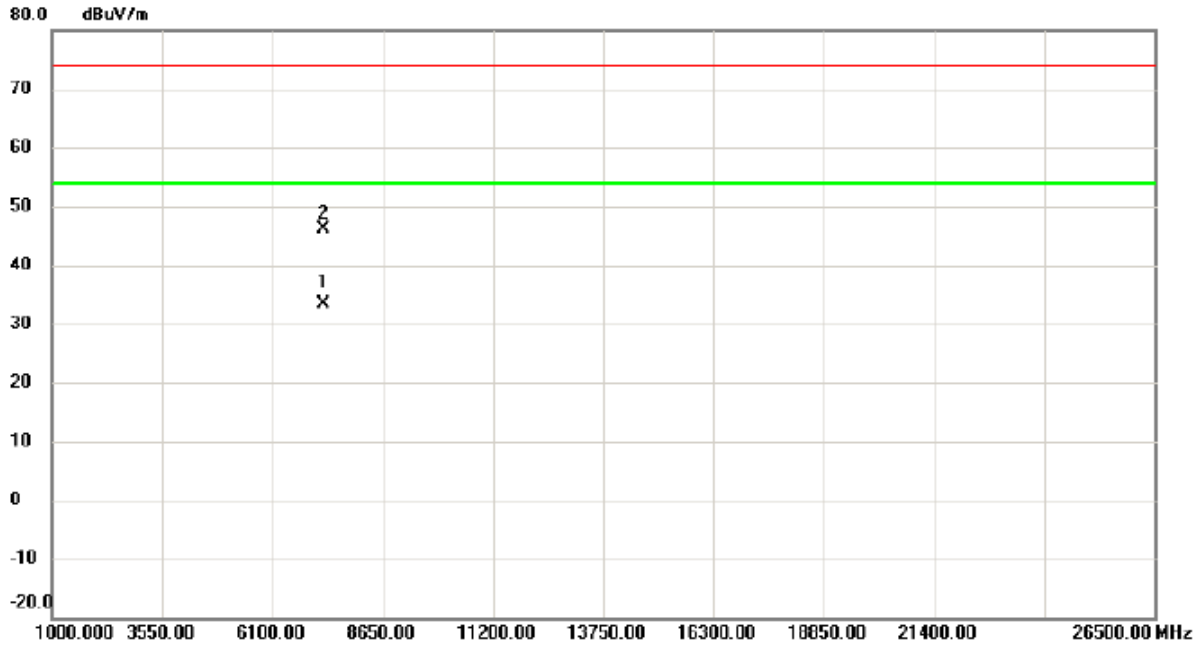

No.	Mk.	Freq. MHz	Reading Level dBuV	Correct Factor dB	Measure- ment dBuV/m	Limit dBuV/m	Margin dB	Detector	Comment
1	*	7276.100	22.68	10.77	33.45	54.00	-20.55	AVG	
2		7286.500	35.38	10.77	46.15	74.00	-27.85	peak	

Orthogonal Axis :	X
Test Mode :	TX N-40M MODE 2437MHz

Vertical

130 dBuV/m

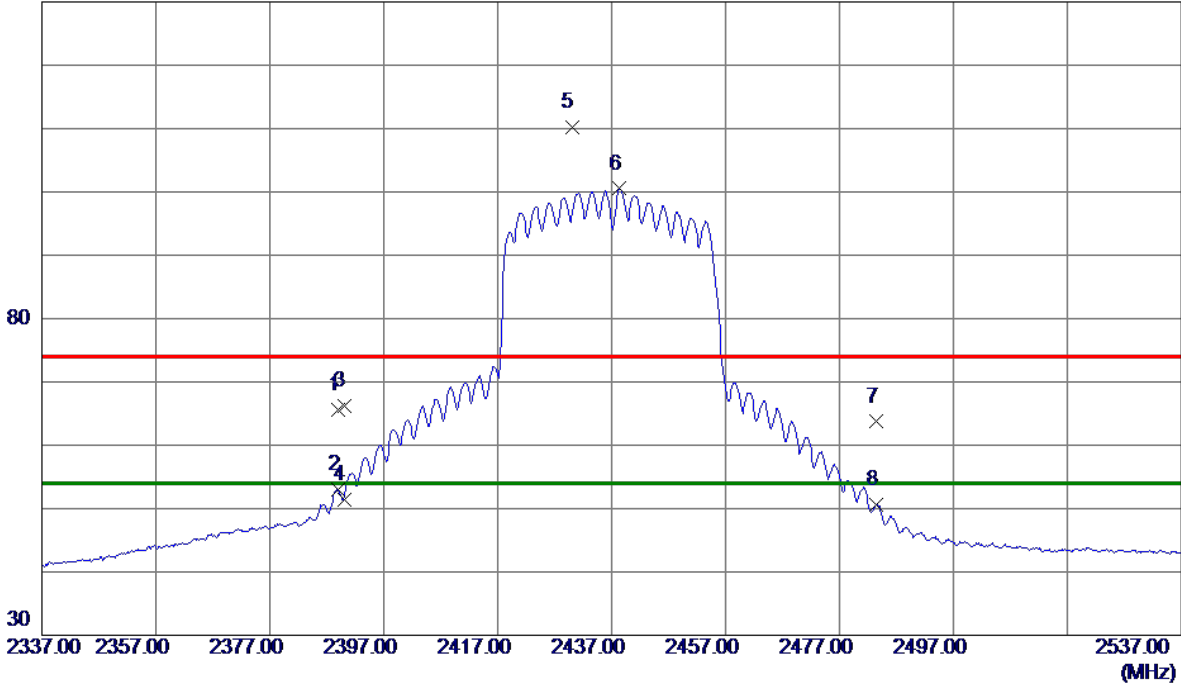

No.	Freq. MHz	Reading Level dBuV/m	Correct Factor dB	Measure ment dBuV/m	Limit dBuV/m	Margin dB	Detector	Comment
1	2389.0000	55.55	10.03	65.58	74.00	-8.42	Peak	
2	2389.0000	42.98	10.03	53.01	54.00	-0.99	AVG	
3	2390.0000	56.18	10.03	66.21	74.00	-7.79	Peak	
4	2390.0000	41.45	10.03	51.48	54.00	-2.52	AVG	
5	2430.0000	100.03	10.14	110.17	74.00	36.17	Peak	No Limit
6 *	2438.4000	90.33	10.17	100.50	54.00	46.50	AVG	No Limit
7	2483.5000	53.41	10.29	63.70	74.00	-10.30	Peak	
8	2483.5000	40.31	10.29	50.60	54.00	-3.40	AVG	

Orthogonal Axis :	X
Test Mode :	TX N-40M MODE 2437MHz

Vertical

80 dBuV/m

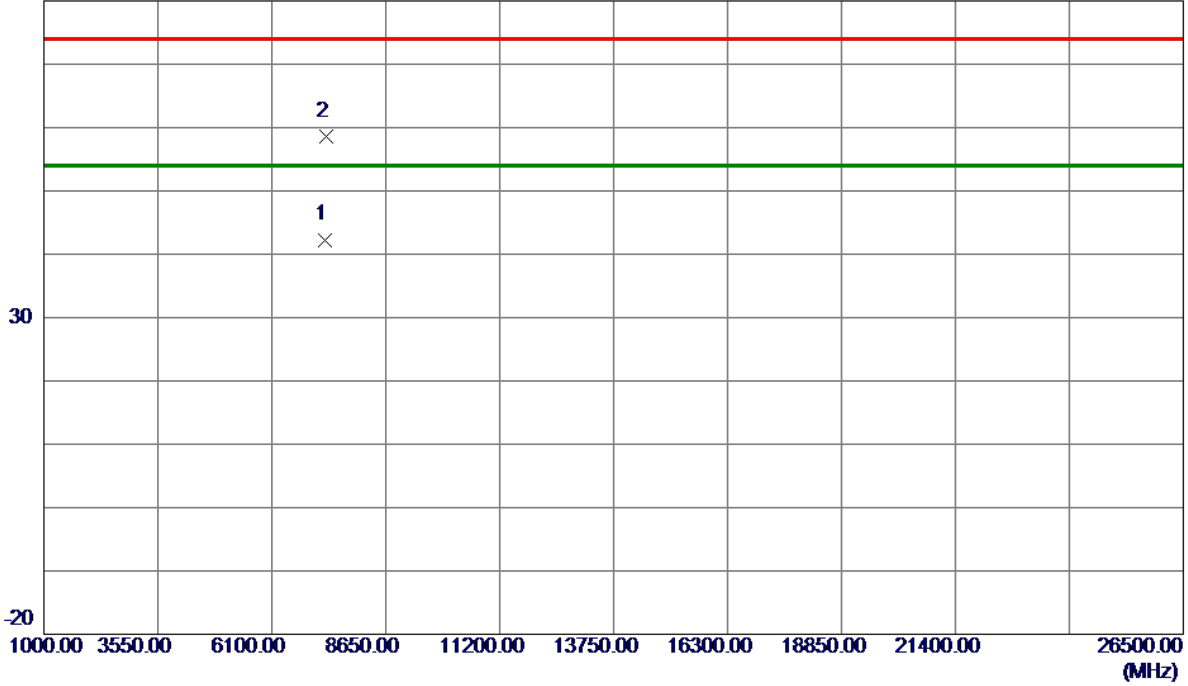

No.	Freq. MHz	Reading Level dBuV/m	Correct Factor dB	Measure ment dBuV/m	Limit dBuV/m	Margin dB	Detector	Comment
1 *	7300.8500	31.51	10.79	42.30	54.00	-11.70	AVG	
2	7321.2500	47.84	10.81	58.65	74.00	-15.35	Peak	

Orthogonal Axis :	X
Test Mode :	TX N-40M MODE 2437MHz

Horizontal

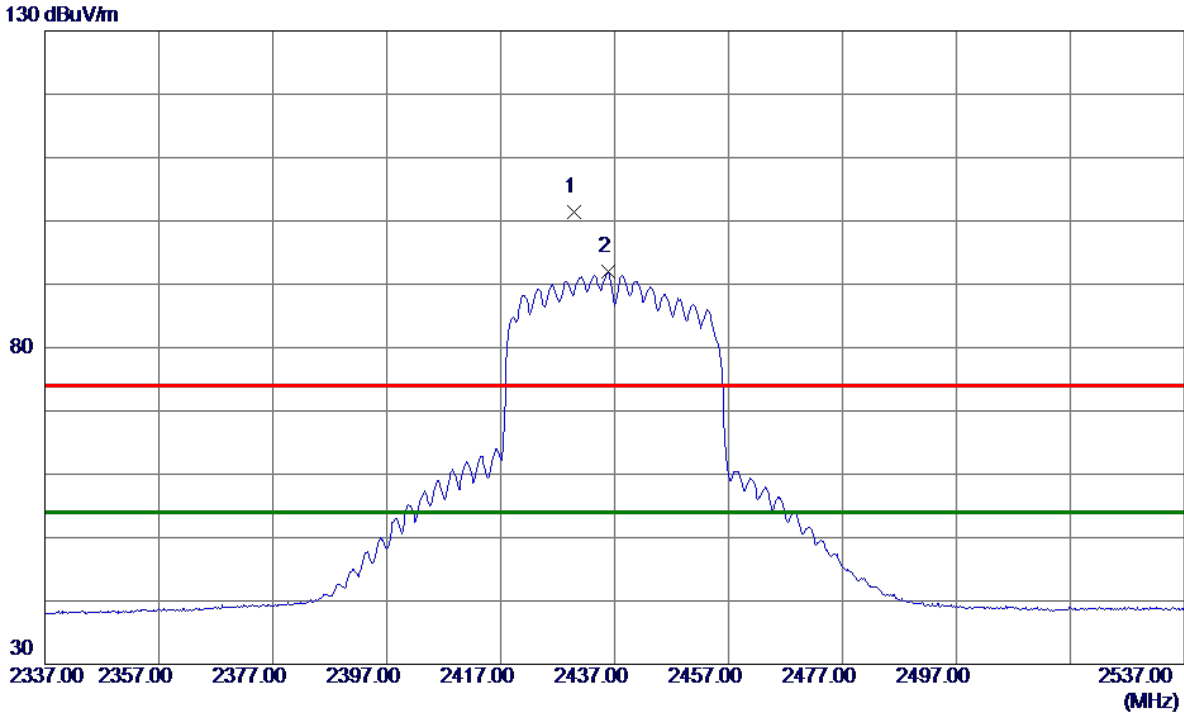

No.	Freq. MHz	Reading Level dBuV/m	Correct Factor dB	Measure ment dBuV/m	Limit dBuV/m	Margin dB	Detector	Comment
1	2429.8000	91.27	10.14	101.41	74.00	27.41	Peak	No Limit
2 *	2435.8000	81.79	10.16	91.95	54.00	37.95	AVG	No Limit

Orthogonal Axis :	X
Test Mode :	TX N-40M MODE 2437MHz

Horizontal

80 dBuV/m

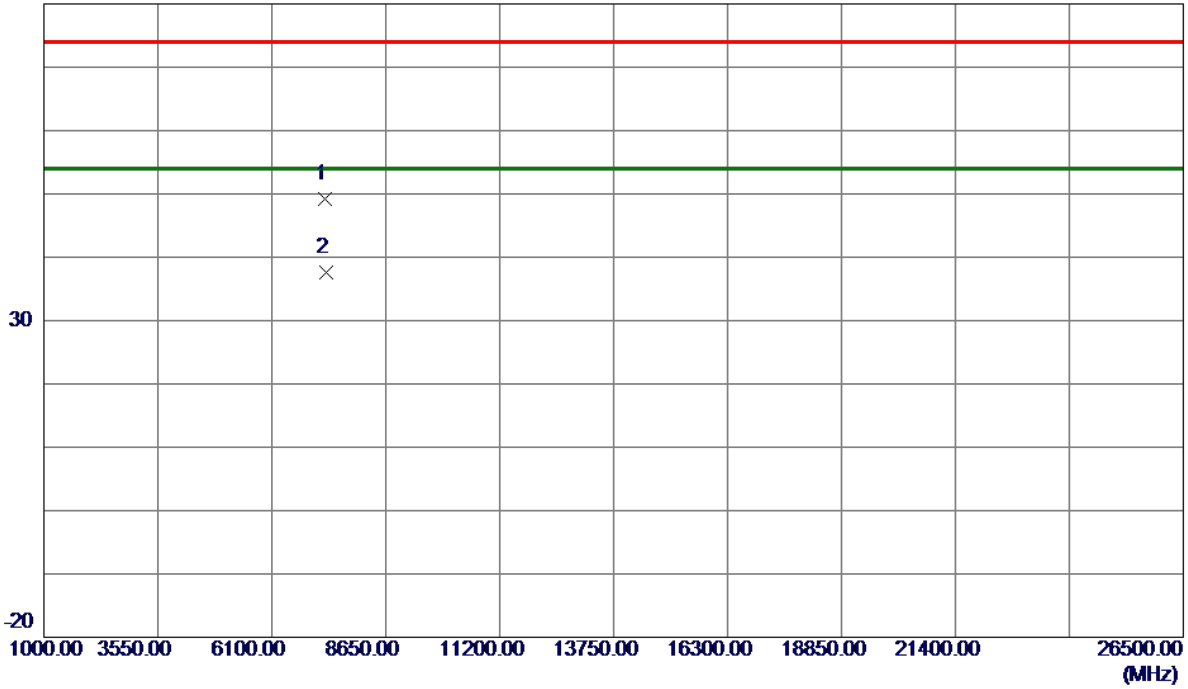

No.	Freq. MHz	Reading Level dBuV/m	Correct Factor dB	Measure ment dBuV/m	Limit dBuV/m	Margin dB	Detector	Comment
1	7301.4000	38.33	10.80	49.13	74.00	-24.87	Peak	
2 *	7313.5000	26.75	10.81	37.56	54.00	-16.44	AVG	

Orthogonal Axis :	X
Test Mode :	TX N-40M MODE 2447MHz

Vertical

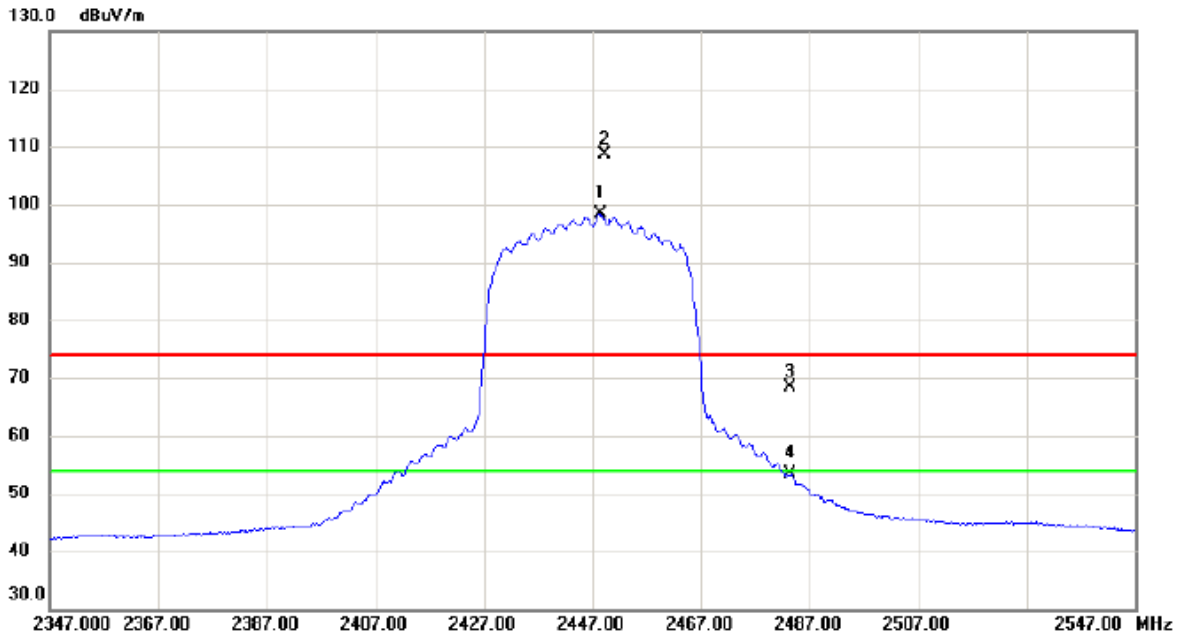

No.	Mk.	Freq. MHz	Reading Level dBuV	Correct Factor dB	Measure- ment dBuV/m	Limit dBuV/m	Margin dB	Detector	Comment
1	*	2448.400	88.10	10.20	98.30	54.00	44.30	AVG	No Limit
2	X	2449.200	98.52	10.20	108.72	74.00	34.72	peak	No Limit
3		2483.500	57.99	10.29	68.28	74.00	-5.72	peak	
4		2483.500	43.18	10.29	53.47	54.00	-0.53	AVG	

Orthogonal Axis :	X
Test Mode :	TX N-40M MODE 2447MHz

Vertical

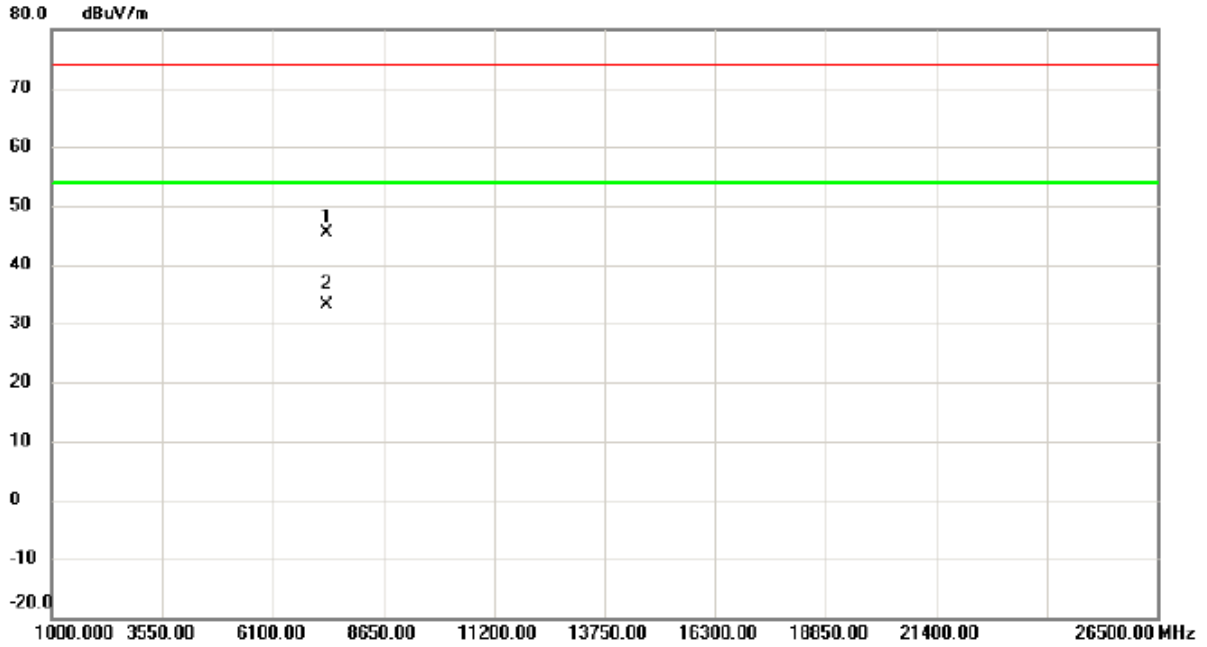

No. Mk.	Freq. MHz	Reading Level dBuV	Correct Factor dB	Measure- ment dBuV/m	Limit dBuV/m	Margin dB	Detector	Comment
1	7336.800	34.55	10.83	45.38	74.00	-28.62	peak	
2 *	7343.900	22.19	10.84	33.03	54.00	-20.97	AVG	

Orthogonal Axis :	X
Test Mode :	TX N-40M MODE 2447MHz

Horizontal

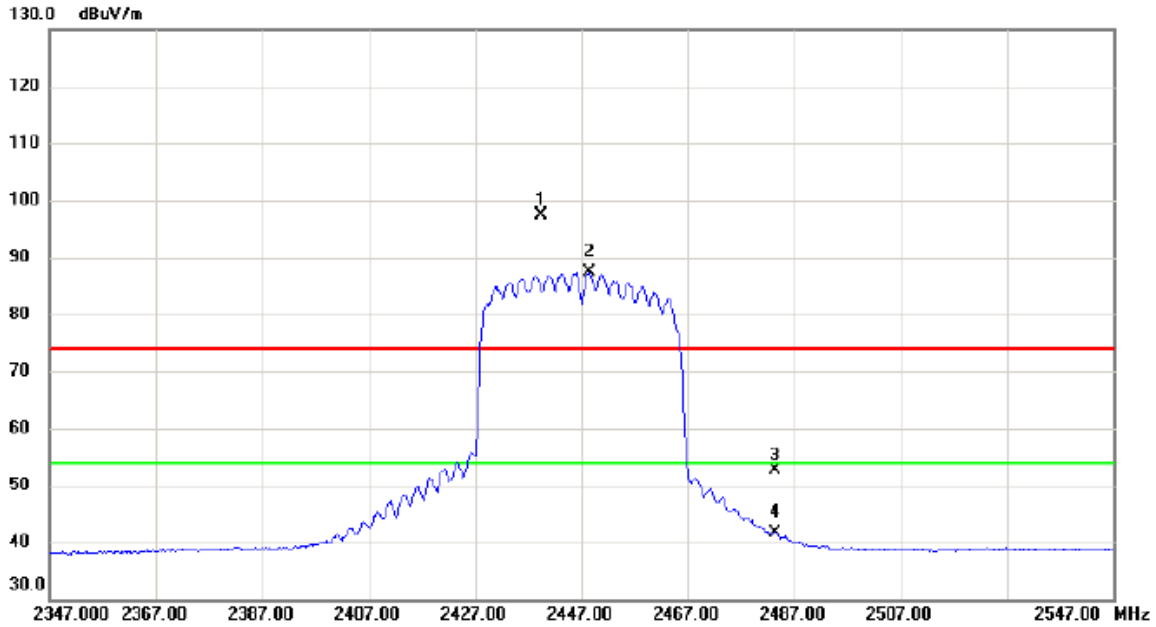

No.	Mk.	Freq. MHz	Reading Level dBuV	Correct Factor dB	Measure- ment dBuV/m	Limit dBuV/m	Margin dB	Detector	Comment
1	X	2439.400	87.30	10.17	97.47	74.00	23.47	peak	No Limit
2	*	2448.400	77.23	10.20	87.43	54.00	33.43	AVG	No Limit
3		2483.500	42.41	10.29	52.70	74.00	-21.30	peak	
4		2483.500	31.24	10.29	41.53	54.00	-12.47	AVG	

Orthogonal Axis :	X
Test Mode :	TX N-40M MODE 2447MHz

Horizontal

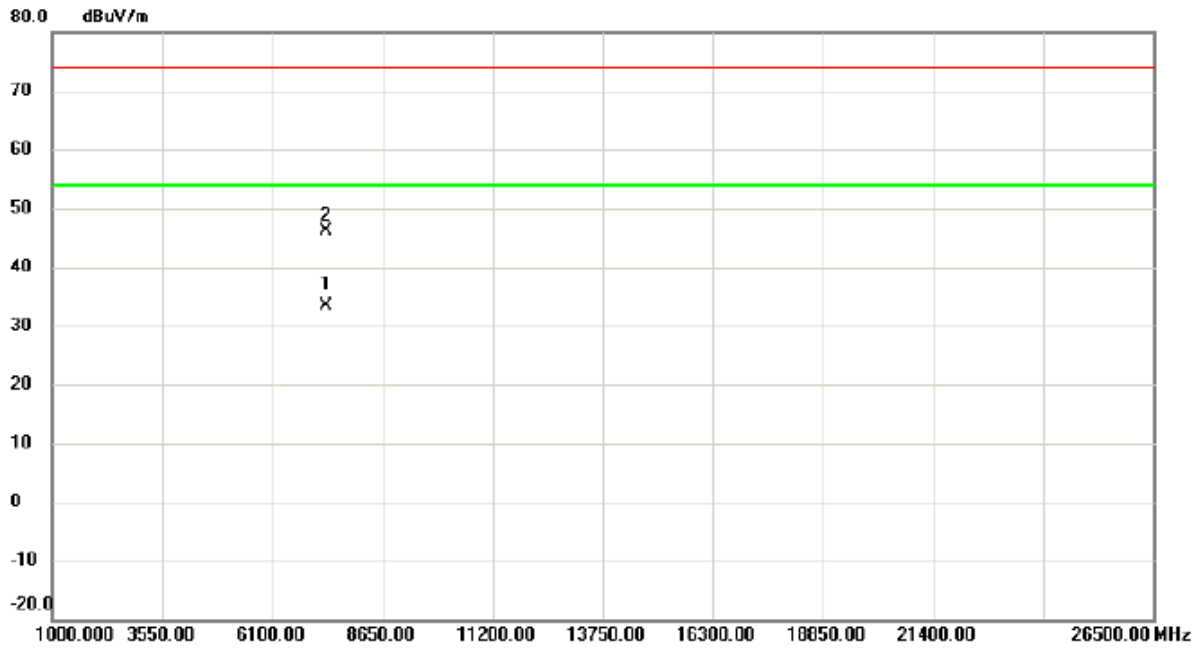

No. Mk.	Freq. MHz	Reading Level dBuV	Correct Factor dB	Measure- ment dBuV/m	Limit dBuV/m	Margin dB	Detector	Comment
1 *	7348.900	22.41	10.85	33.26	54.00	-20.74	AVG	
2	7349.500	35.19	10.85	46.04	74.00	-27.96	peak	

Orthogonal Axis :	X
Test Mode :	TX N-40M MODE 2452MHz

Vertical

130 dBuV/m

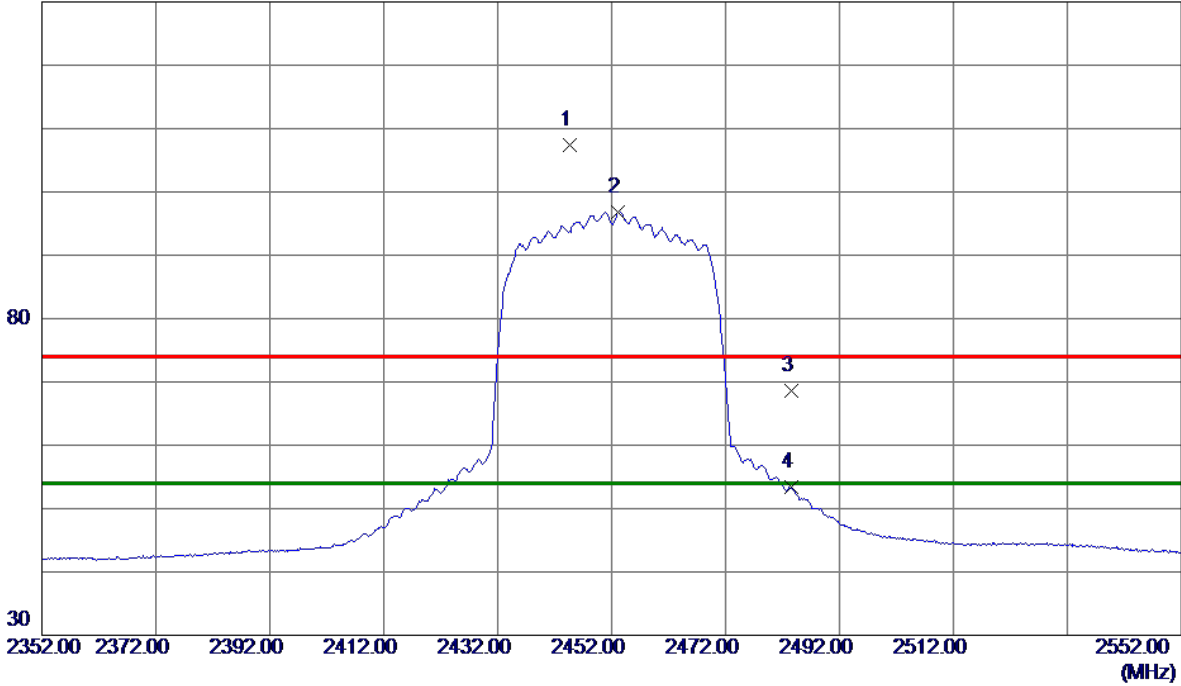

No.	Freq. MHz	Reading Level dBuV/m	Correct Factor dB	Measure ment dBuV/m	Limit dBuV/m	Margin dB	Detector	Comment
1	2444.6000	97.18	10.18	107.36	74.00	33.36	Peak	No Limit
2 *	2453.2000	86.60	10.21	96.81	54.00	42.81	AVG	No Limit
3	2483.5000	58.24	10.29	68.53	74.00	-5.47	Peak	
4	2483.5000	43.02	10.29	53.31	54.00	-0.69	AVG	

Orthogonal Axis :	X
Test Mode :	TX N-40M MODE 2452MHz

Vertical

80 dBuV/m

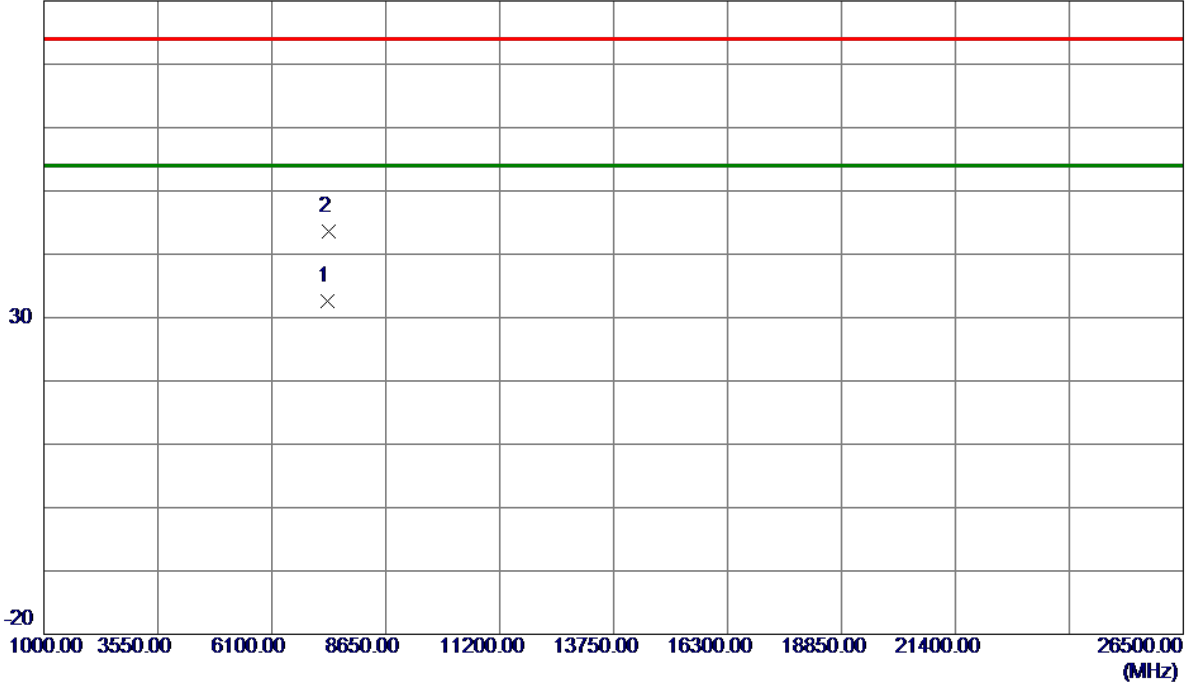

No.	Freq. MHz	Reading Level dBuV/m	Correct Factor dB	Measure ment dBuV/m	Limit dBuV/m	Margin dB	Detector	Comment
1 *	7351.8000	21.76	10.84	32.60	54.00	-21.40	AVG	
2	7378.5000	32.81	10.87	43.68	74.00	-30.32	Peak	

Orthogonal Axis :	X
Test Mode :	TX N-40M MODE 2452MHz

Horizontal

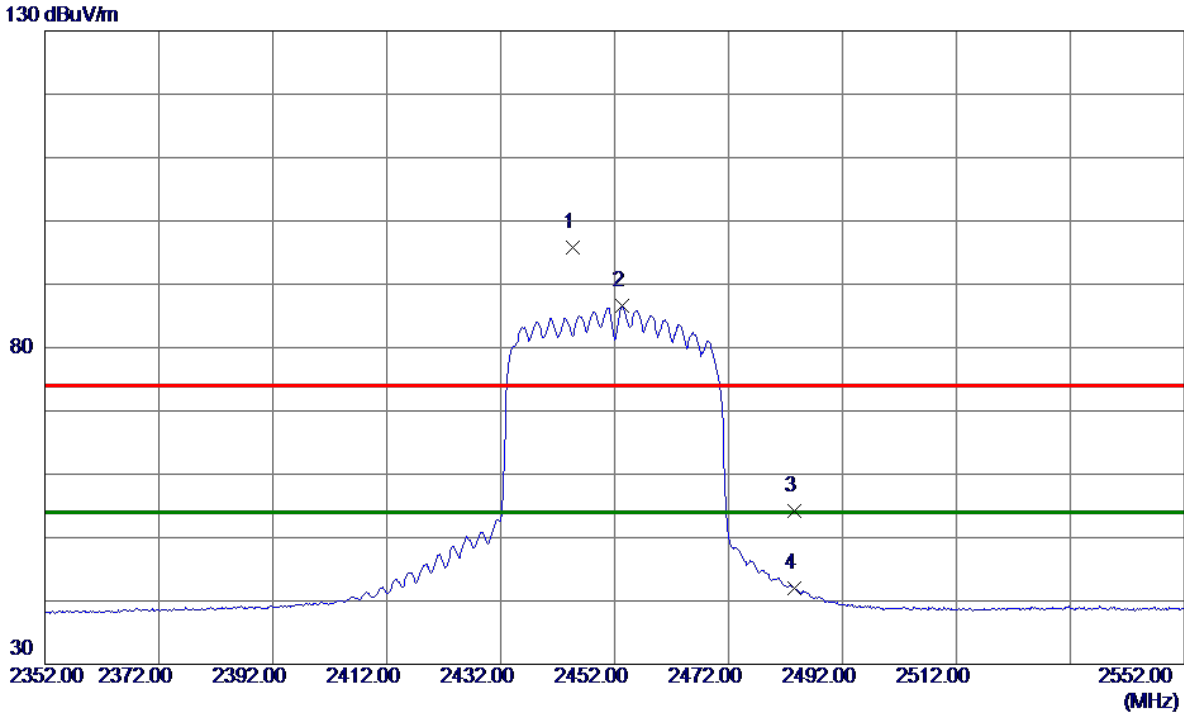

No.	Freq. MHz	Reading Level dBuV/m	Correct Factor dB	Measure ment dBuV/m	Limit dBuV/m	Margin dB	Detector	Comment
1	2444.6000	85.58	10.18	95.76	74.00	21.76	Peak	No Limit
2 *	2453.4000	76.46	10.21	86.67	54.00	32.67	AVG	No Limit
3	2483.5000	43.94	10.29	54.23	74.00	-19.77	Peak	
4	2483.5000	31.71	10.29	42.00	54.00	-12.00	AVG	

Orthogonal Axis :	X
Test Mode :	TX N-40M MODE 2452MHz

Horizontal

80 dBuV/m

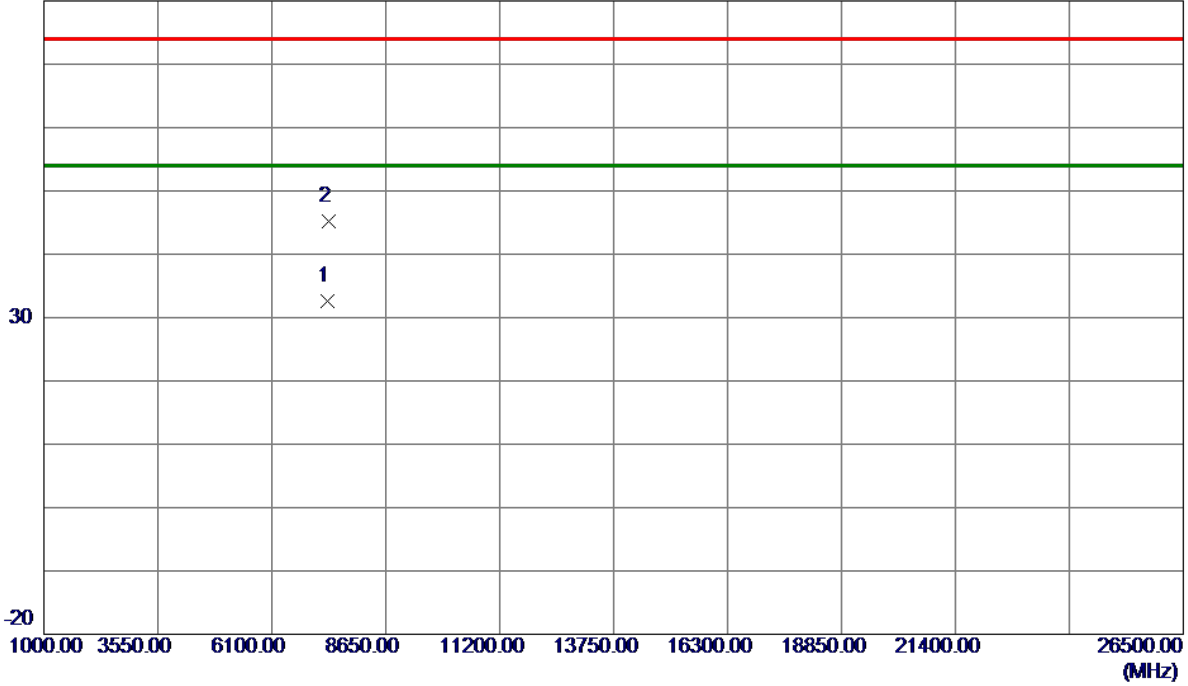

No.	Freq. MHz	Reading Level dBuV/m	Correct Factor dB	Measure ment dBuV/m	Limit dBuV/m	Margin dB	Detector	Comment
1 *	7359.0000	21.80	10.85	32.65	54.00	-21.35	AVG	
2	7369.1000	34.42	10.86	45.28	74.00	-28.72	Peak	

APPENDIX E - BANDWIDTH

Test Mode : TX B Mode_CH01/06/11

Frequency (MHz)	6dB Bandwidth (MHz)	99% Occupied BW (MHz)	Min. Limit (kHz)	Test Result
2412	10.08	14.72	500	Complies
2437	10.08	14.72	500	Complies
2462	10.07	14.76	500	Complies

TX CH01

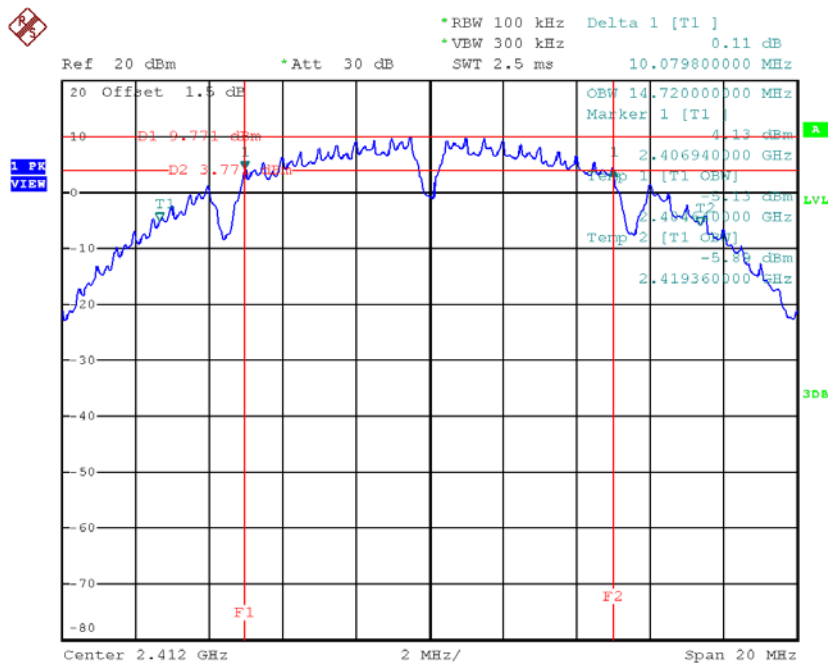

Date: 17.APR.2018 20:01:47

TX CH06

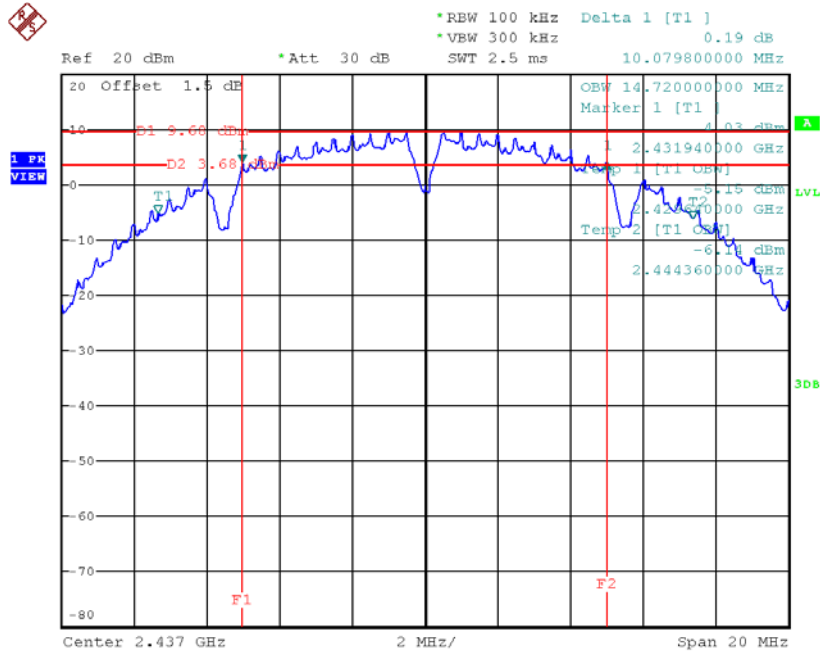

Date: 17.APR.2018 20:04:17

TX CH11

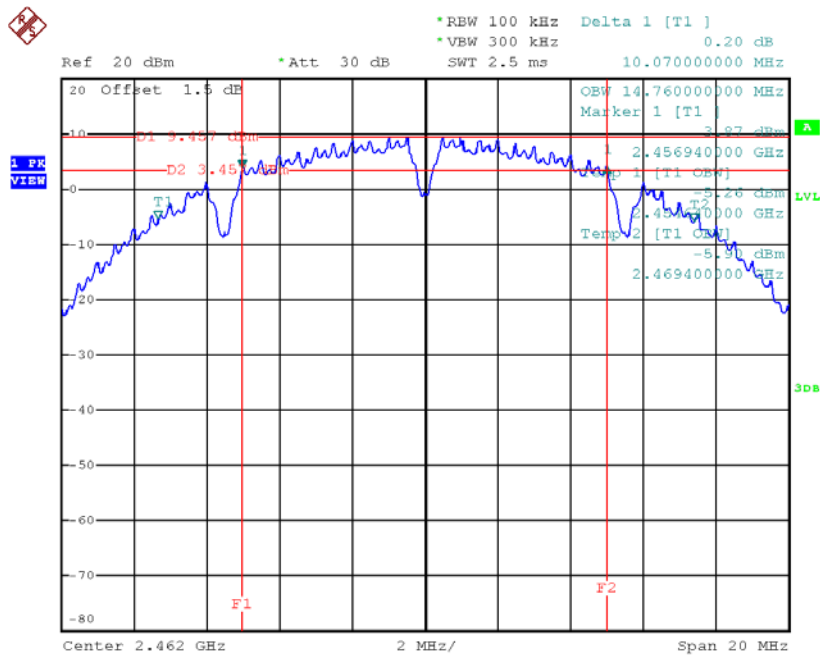

Date: 17.APR.2018 20:09:17

Test Mode: TX G Mode_CH01/06/11

Frequency (MHz)	6dB Bandwidth (MHz)	99% Occupied BW (MHz)	Min. Limit (kHz)	Test Result
2412	13.93	16.32	500	Complies
2437	15.06	16.4	500	Complies
2462	15.1	16.36	500	Complies

TX CH01

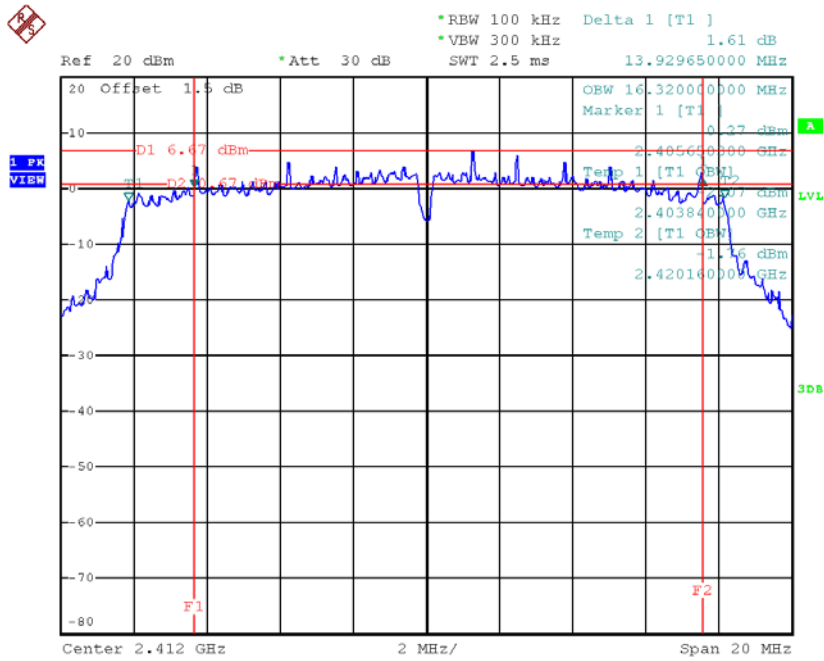

Date: 17.APR.2018 20:14:17

TX CH06

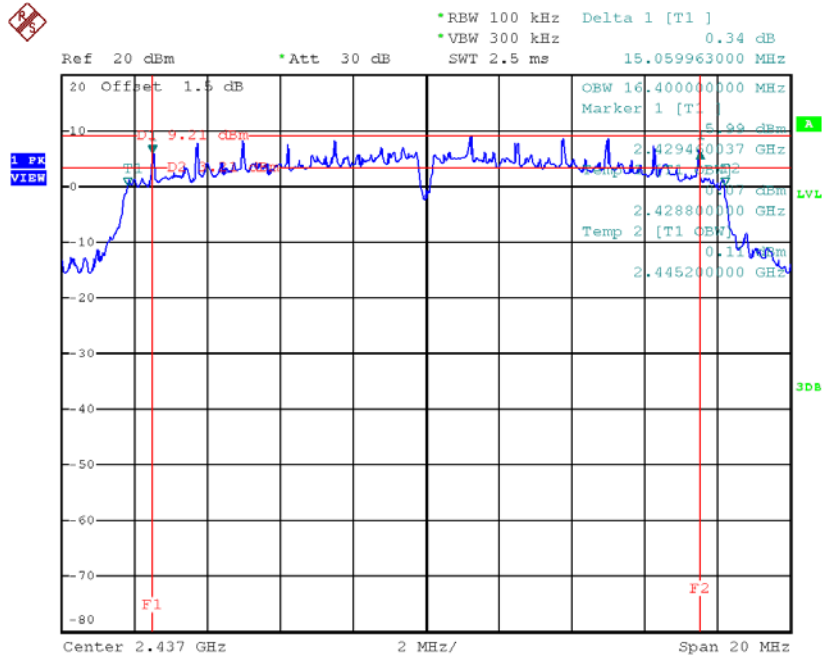

Date: 17.APR.2018 20:18:17

TX CH11

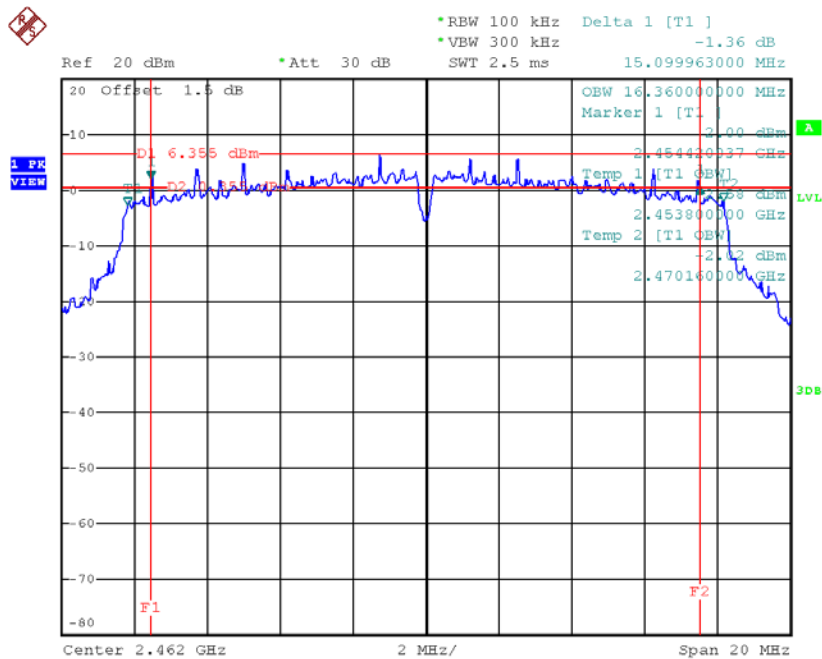

Date: 17.APR.2018 20:21:47

Test Mode : TX N-20MHz Mode_CH01/06/11

Frequency (MHz)	6dB Bandwidth (MHz)	99% Occupied BW (MHz)	Min. Limit (kHz)	Test Result
2412	15.2	17.52	500	Complies
2437	13.9	17.6	500	Complies
2462	15.05	17.56	500	Complies

TX CH01

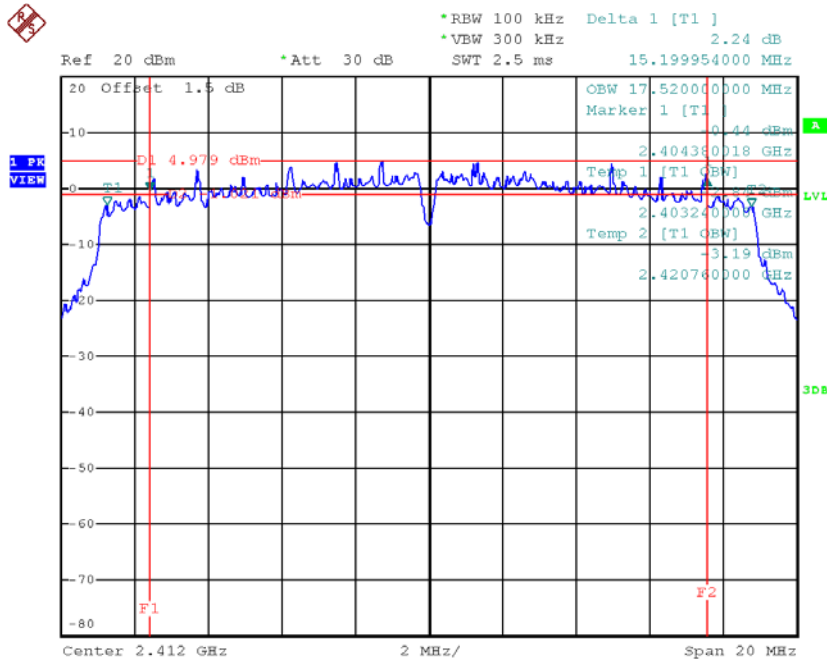

Date: 17.APR.2018 20:24:47

TX CH06

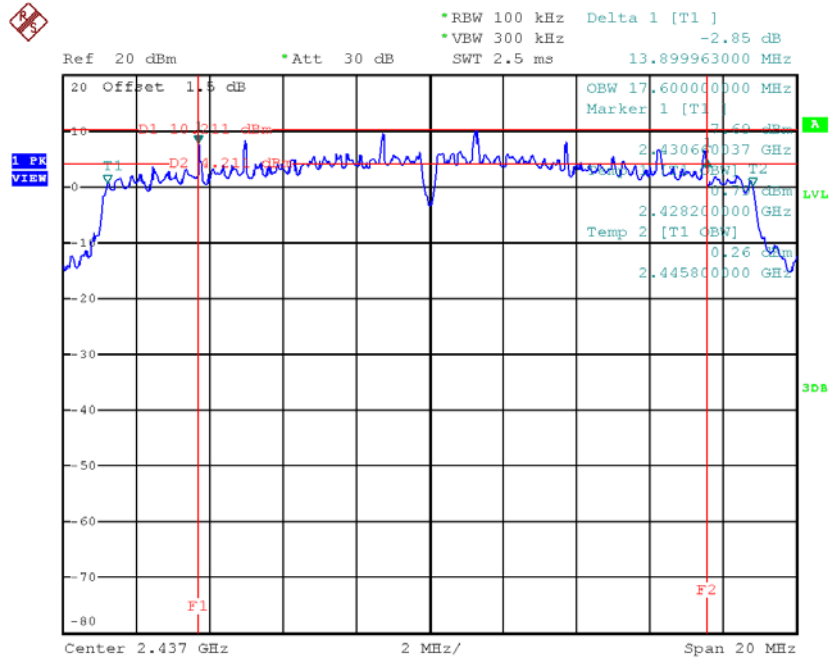

Date: 17.APR.2018 20:26:47

TX CH11

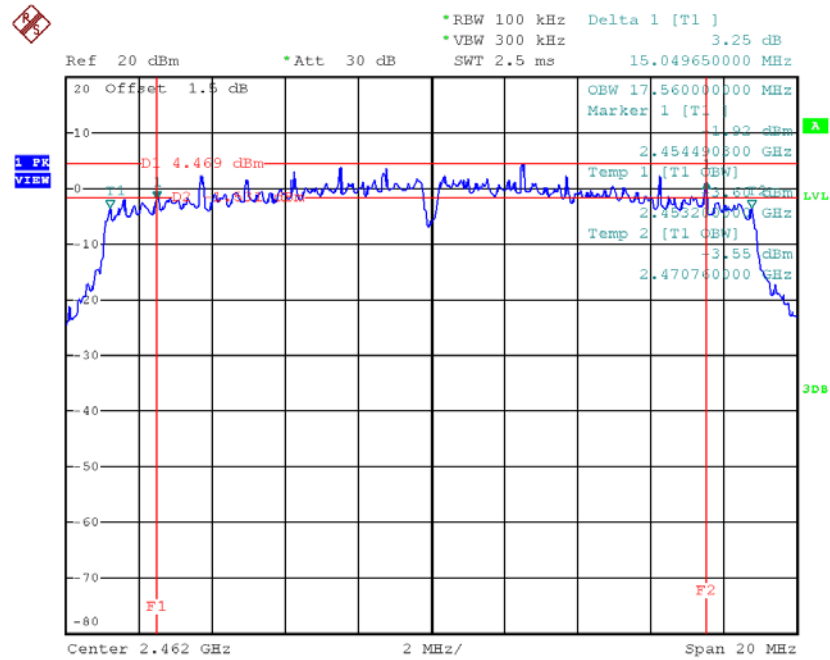

Date: 17.APR.2018 20:28:47

Test Mode : TX N-40MHz Mode_CH03/06/09

Frequency (MHz)	6dB Bandwidth (MHz)	99% Occupied BW (MHz)	Min. Limit (kHz)	Test Result
2422	35.12	35.76	500	Complies
2437	35.28	35.84	500	Complies
2452	35.08	35.84	500	Complies

TX CH03

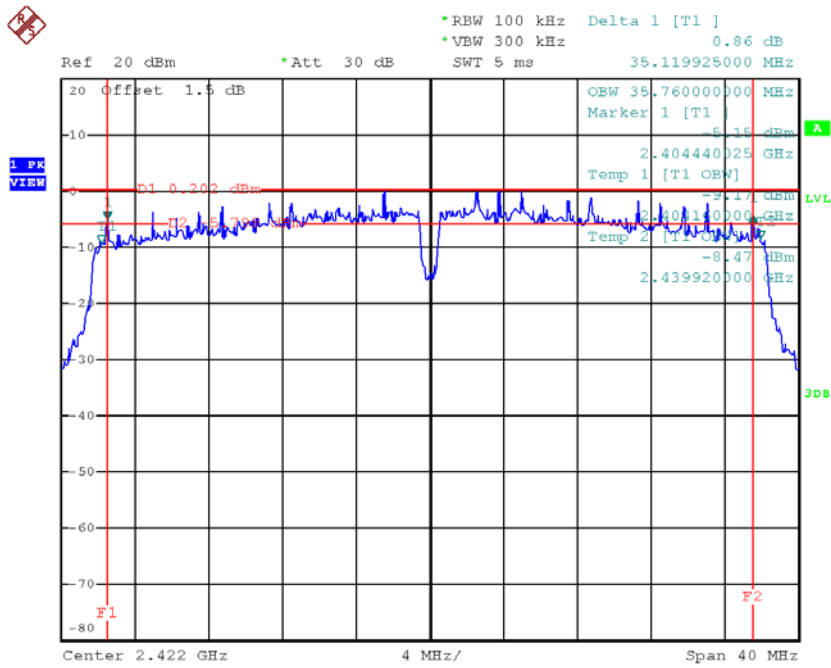

Date: 20.APR.2018 16:53:33