

FCC AND ISED CERTIFICATION TEST REPORT

FOR

| | | |
|-----------------------------|---|---|
| Applicant | : | ION Audio, LLC |
| Address | : | 200 Scenic View Drive, Cumberland, RI 02864 U.S.A. |
| Equipment under Test | : | HIGH-POWER BLUETOOTH-ENABLED SPEAKER SYSTEM WITH LIGHTS |
| Model No. | : | Total PA Glow Max |
| Project Code | : | iPA122A |
| Trade Mark | : |  |
| FCC ID | : | 2AB3E-IPA122A |
| IC | : | 10541A-IPA122A |
| Manufacturer | : | ION Audio, LLC |
| Address | : | 200 Scenic View Drive, Cumberland, RI 02864 U.S.A. |

Issued By: Dongguan Dongdian Testing Service Co., Ltd.

Add.: No. 17, Zongbu Road 2, Songshan Lake Sci&Tech, Industry Park,
Dongguan City, Guangdong Province, China, 523808

Tel.: +86-0769-38826678, **E-mail:** ddt@dgddt.com, <http://www.dgddt.com>

REPORT

Table of Contents

| | | |
|------|--|----|
| | Test report declares..... | 4 |
| 1. | Summary of Test Results..... | 6 |
| 2. | General Test Information | 7 |
| 2.1. | Description of EUT | 7 |
| 2.2. | Accessories of EUT..... | 8 |
| 2.3. | Assistant equipment used for test..... | 8 |
| 2.4. | Block diagram of EUT configuration for test..... | 9 |
| 2.5. | Deviations of test standard..... | 9 |
| 2.6. | Test environment conditions | 10 |
| 2.7. | Test laboratory..... | 10 |
| 2.8. | Measurement uncertainty..... | 10 |
| 3. | Equipment Used During Test..... | 11 |
| 4. | Maximum Peak Output Power | 13 |
| 4.1. | Block diagram of test setup..... | 13 |
| 4.2. | Limits | 13 |
| 4.3. | Test procedure | 13 |
| 4.4. | Test result..... | 13 |
| 4.5. | Original test data | 14 |
| 5. | 20 dB Bandwidth and 99% Bandwidth..... | 17 |
| 5.1. | Block diagram of test setup..... | 17 |
| 5.2. | Limits | 17 |
| 5.3. | Test procedure | 17 |
| 5.4. | Test result..... | 17 |
| 5.5. | Original test data | 18 |
| 6. | Carrier Frequency Separation..... | 21 |
| 6.1. | Block diagram of test setup..... | 21 |
| 6.2. | Limits | 21 |
| 6.3. | Test procedure | 21 |
| 6.4. | Test result..... | 21 |
| 6.5. | Original test data | 22 |
| 7. | Number of Hopping Channel | 23 |
| 7.1. | Block diagram of test setup..... | 23 |
| 7.2. | Limits | 23 |
| 7.3. | Test procedure | 23 |
| 7.4. | Test result..... | 23 |
| 7.5. | Original test data | 23 |

| | | |
|-------|---|----|
| 8. | Dwell Time | 25 |
| 8.1. | Block diagram of test setup..... | 25 |
| 8.2. | Limits | 25 |
| 8.3. | Test procedure | 25 |
| 8.4. | Test result..... | 25 |
| 8.5. | Original test data | 26 |
| 9. | Band Edge Compliance (Conducted Method) | 32 |
| 9.1. | Block diagram of test setup..... | 32 |
| 9.2. | Limit..... | 32 |
| 9.3. | Test result..... | 32 |
| 9.4. | Original test data | 32 |
| 10. | Radiated Emission | 37 |
| 10.1. | Block diagram of test setup..... | 37 |
| 10.2. | Limit..... | 38 |
| 10.3. | Test procedure | 39 |
| 10.4. | Test result..... | 41 |
| 11. | RF Conducted Spurious Emissions | 45 |
| 11.1. | Block diagram of test setup..... | 45 |
| 11.2. | Limits | 45 |
| 11.3. | Test procedure | 45 |
| 11.4. | Test result..... | 46 |
| 11.5. | Original test data | 46 |
| 12. | Band Edge Compliance (Radiated Method) | 56 |
| 12.1. | Block diagram of test setup..... | 56 |
| 12.2. | Limit..... | 56 |
| 12.3. | Test procedure | 56 |
| 12.4. | Test result..... | 56 |
| 13. | Power Line Conducted Emission | 69 |
| 13.1. | Block diagram of test setup..... | 69 |
| 13.2. | Power line conducted emission limits..... | 69 |
| 13.3. | Test procedure | 69 |
| 13.4. | Test result..... | 70 |
| 14. | Antenna Requirements | 73 |
| 14.1. | Limit..... | 73 |
| 14.2. | Result | 73 |

Test Report Declare

| | | |
|-----------------------------|---|---|
| Applicant | : | ION Audio, LLC |
| Address | : | 200 Scenic View Drive, Cumberland, RI 02864 U.S.A. |
| Equipment under Test | : | HIGH-POWER BLUETOOTH-ENABLED SPEAKER SYSTEM WITH LIGHTS |
| Model No. | : | Total PA Glow Max |
| Trade Mark | : |  |
| Manufacturer | : | ION Audio, LLC |
| Address | : | 200 Scenic View Drive, Cumberland, RI 02864 U.S.A. |

Test Standard Used:

FCC Rules and Regulations Part 15 Subpart C, RSS-247 Issue 2 February 2017.

Test Procedure Used:

ANSI C63.10:2013, RSS-Gen Issue 5, Apr. 2018.

We Declare:

The equipment described above is tested by Dongguan Dongdian Testing Service Co., Ltd. and in the configuration tested the equipment complied with the standards specified above. The test results are contained in this test report and Dongguan Dongdian Testing Service Co., Ltd. is assumed of full responsibility for the accuracy and completeness of these tests.

After test and evaluation, our opinion is that the equipment provided for test compliance with the requirement of the above FCC&ISED standards.

| | | | |
|-------------------------|-------------------|----------------------|-------------------------------|
| Report No.: | DDT-R20101602-1E2 | | |
| Date of Receipt: | Oct. 19, 2020 | Date of Test: | Oct. 19, 2020 ~ Dec. 10, 2020 |

Prepared By:

Sam Li

Sam Li/Engineer

Approved By:

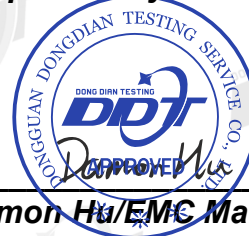

Damon Hu/EMC Manager

Note: This report applies to above tested sample only. This report shall not be reproduced in parts without written approval of Dongguan Dongdian Testing Service Co., Ltd.

Revision History

| Rev. | Revisions | Issue Date | Revised By |
|------|---------------|---------------|------------|
| --- | Initial issue | Dec. 11, 2020 | |
| | | | |

1. Summary of Test Results

| Description of Test Item | Standard | Results |
|-----------------------------------|---|---------|
| Maximum Peak Output Power | FCC Part 15: 15.247(b)(1) ANSI C63.10:2013 RSS-247 Issue 2 | Pass |
| 20 dB Bandwidth and 99% Bandwidth | FCC Part 15: 15.215 ANSI C63.10:2013 RSS-247 Issue 2 | Pass |
| Carrier Frequency Separation | FCC Part 15: 15.247(a)(1) ANSI C63.10:2013 RSS-247 Issue 2 | Pass |
| Number of Hopping Channel | FCC Part 15: 15.247(a)(1)(iii) ANSI C63.10:2013 RSS-247 Issue 2 | Pass |
| Dwell Time | FCC Part 15: 15.247(a)(1)(iii) ANSI C63.10:2013 RSS-247 Issue 2 | Pass |
| Radiated Emission | FCC Part 15: 15.209 FCC Part 15: 15.247(d) ANSI C63.10:2013 RSS-247 Issue 2 RSS-Gen Issue 5 | Pass |
| Band Edge Compliance | FCC Part 15: 15.247(d) ANSI C63.10:2013 RSS-247 Issue 2 RSS-Gen Issue 5 | Pass |
| Power Line Conducted Emissions | FCC Part 15: 15.207 ANSI C63.10:2013 RSS-Gen Issue 5 | Pass |
| Antenna Requirement | FCC Part 15: 15.203 RSS-Gen Issue 5 | Pass |

2. General Test Information

2.1. Description of EUT

| | |
|--------------------------|---|
| EUT* Name | : HIGH-POWER BLUETOOTH-ENABLED SPEAKER SYSTEM WITH LIGHTS |
| Model Number | : Total PA Glow Max |
| EUT Function Description | : Please reference user manual of this device |
| Power Supply | : AC 100-120V~, 60Hz |
| Radio Specification | : Bluetooth V5.1 |
| Operation Frequency | : 2402 MHz - 2480 MHz |
| Modulation | : GFSK, $\pi/4$ -DQPSK, 8DPSK |
| Data Rate | : 1 Mbps, 2 Mbps, 3 Mbps |
| Antenna Type | : Integral PCB antenna, maximum PK gain: -0.58 dBi |
| Serial Number | : N/A |

Note: EUT is the abbreviation of equipment under test.

| Channel Information | | | | | |
|---------------------|-----------------|---------|-----------------|---------|-----------------|
| Channel | Frequency (MHz) | Channel | Frequency (MHz) | Channel | Frequency (MHz) |
| 0 | 2402 | 27 | 2429 | 54 | 2456 |
| 1 | 2403 | 28 | 2430 | 55 | 2457 |
| 2 | 2404 | 29 | 2431 | 56 | 2458 |
| 3 | 2405 | 30 | 2432 | 57 | 2459 |
| 4 | 2406 | 31 | 2433 | 58 | 2460 |
| 5 | 2407 | 32 | 2434 | 59 | 2461 |
| 6 | 2408 | 33 | 2435 | 60 | 2462 |
| 7 | 2409 | 34 | 2436 | 61 | 2463 |
| 8 | 2410 | 35 | 2437 | 62 | 2464 |
| 9 | 2411 | 36 | 2438 | 63 | 2465 |
| 10 | 2412 | 37 | 2439 | 64 | 2466 |
| 11 | 2413 | 38 | 2440 | 65 | 2467 |
| 12 | 2414 | 39 | 2441 | 66 | 2468 |
| 13 | 2415 | 40 | 2442 | 67 | 2469 |
| 14 | 2416 | 41 | 2443 | 68 | 2470 |
| 15 | 2417 | 42 | 2444 | 69 | 2471 |
| 16 | 2418 | 43 | 2445 | 70 | 2472 |
| 17 | 2419 | 44 | 2446 | 71 | 2473 |
| 18 | 2420 | 45 | 2447 | 72 | 2474 |
| 19 | 2421 | 46 | 2448 | 73 | 2475 |
| 20 | 2422 | 47 | 2449 | 74 | 2476 |
| 21 | 2423 | 48 | 2450 | 75 | 2477 |
| 22 | 2424 | 49 | 2451 | 76 | 2478 |
| 23 | 2425 | 50 | 2452 | 77 | 2479 |
| 24 | 2426 | 51 | 2453 | 78 | 2480 |
| 25 | 2427 | 52 | 2454 | | |
| 26 | 2428 | 53 | 2455 | | |

2.2. Accessories of EUT

| Description of Accessories | Manufacturer | Model number | Serial No. | Other |
|----------------------------|---|------------------------|---|--------------------------|
| AC cable | N/A | N/A | N/A | Length: 1.5m, unshielded |
| Microphone | N/A | N/A | N/A | Length: 4.50m, shielded |
| Remote control | N/A | N/A | N/A | N/A |
| Magnet | ShenZhen VIIP Electronic Co., Ltd. | V180185T | N/A | 25*15*12mm |
| Magnet | ShenZhen VIIP Electronic Co., Ltd. | N/A | N/A | 22*14*8mm |
| Light control board | Guangzhou Yongchen Technology Co., Ltd | N/A | N/A | Optional |
| | Guangzhou brilliant electronic co. LTD | N/A | N/A | |
| Mains linear transformer | NINGBO ZHONGCE E.T ELECTRONICS CO., LTD | CDB-280T-1 20-37-3A | Input: 0-120VAC 60Hz Output: 37V-0-37VAC Max 3.0A 17V-0-17VAC Max 1.2A 0-12VAC Max 1.0A 0-12VAC Max 1.5A | Optional |
| | Ningbo Rongqian Electrical Appliance Co., Ltd | CDB-280T-1 20-37-3A | Input: 0-120VAC 60Hz Output: 37V-0-37VAC Max 3.0A 17V-0-17VAC Max 1.2A 0-12VAC Max 1.0A 0-12VAC Max 1.5A | |
| | YUYAO ZHONG CHI ELECTRIC ALAPPLIANCE. CO. LTD | CDB-280T-1 20-37-3A | Input: 0-120VAC 60Hz Output: 37V-0-37VAC Max 3.0A 17V-0-17VAC Max 1.2A 0-12VAC Max 1.0A 0-12VAC Max 1.5A | |
| | Ningbo Yaolisi Electrical Appliance Co., Ltd | CDB-280T-1 20-37-3A | Input: 0-120VAC 60Hz Output: 37V-0-37VAC Max 3.0A 17V-0-17VAC Max 1.2A 0-12VAC Max 1.0A 0-12VAC Max 1.5A | |

2.3. Assistant equipment used for test

| Assistant equipment | Manufacturer | Model number | EMC Compliance | SN |
|---------------------|-------------------------|--------------|----------------|----------|
| Notebook | Lenovo Beijing Co. Ltd. | ThinkPad | FCC/CE | TP00015A |

2.4. Block diagram of EUT configuration for test

EUT

Test software: FCC Assist.EXE

The test software was used to control EUT work in Continuous Tx mode, and select test channel, wireless mode as below table.

| Tested mode, channel, information | | | |
|------------------------------------|------------------|-------------|-----------------|
| Mode | Setting Tx Power | Channel | Frequency (MHz) |
| GFSK hopping on Tx mode | / | CH0 to CH78 | 2402 to 2480 |
| $\pi/4$ -DQPSK hopping on Tx mode | / | CH0 to CH78 | 2402 to 2480 |
| 8DPSK hopping on Tx mode | / | CH0 to CH78 | 2402 to 2480 |
| GFSK hopping off Tx mode | / | CH0 | 2402 |
| | / | CH39 | 2441 |
| | / | CH78 | 2480 |
| $\pi/4$ -DQPSK hopping off Tx mode | / | CH0 | 2402 |
| | / | CH39 | 2441 |
| | / | CH78 | 2480 |
| 8DPSK hopping off Tx mode | / | CH0 | 2402 |
| | / | CH39 | 2441 |
| | / | CH78 | 2480 |

2.5. Deviations of test standard

No deviation.

2.6. Test environment conditions

During the measurement the environmental conditions were within the listed ranges:

| | |
|--------------------|------------|
| Temperature range: | 21-25 °C |
| Humidity range: | 40-75% |
| Pressure range: | 86-106 kPa |

2.7. Test laboratory

Dongguan Dongdian Testing Service Co., Ltd.

Add.: No. 17, Zongbu Road 2, Songshan Lake Sci&Tech, Industry Park, Dongguan City, Guangdong Province, China, 523808

Tel.: +86-0769-38826678, <http://www.dgddt.com>, Email: ddt@dgddt.com

CNAS Registration No. CNAS L6451; A2LA Certificate Number: 3870.01;

FCC Designation Number: CN1182; FCC Test Firm Registration Number: 540522

Industry Canada Site Registration Number: 10288A-1

2.8. Measurement uncertainty

| Test Item | Uncertainty |
|--|--|
| Bandwidth | 1.1% |
| Peak Output Power (Conducted) (Spectrum Analyzer) | 0.86 dB (10 MHz ≤ f < 3.6 GHz); |
| | 1.38 dB (3.6 GHz ≤ f < 8 GHz) |
| Peak Output Power (Conducted) (Power Sensor) | 0.74 dB |
| Power Spectral Density | 0.74 dB (10 MHz ≤ f < 3.6 GHz); |
| | 1.38 dB (3.6 GHz ≤ f < 8 GHz) |
| Frequencies Stability | 6.7×10^{-8} (Antenna couple method) |
| | 5.5×10^{-8} (Conducted method) |
| Conducted Spurious Emissions | 0.86 dB (10 MHz ≤ f < 3.6 GHz); |
| | 1.40 dB (3.6 GHz ≤ f < 8 GHz) |
| | 1.66 dB (8 GHz ≤ f < 22 GHz) |
| Uncertainty for Radio Frequency (RBW < 20 kHz) | 3×10^{-8} |
| Temperature | 0.4 °C |
| Humidity | 2 % |
| Uncertainty for Radiation Emission Test (30 MHz - 1 GHz) | 4.70 dB (Antenna Polarize: V) |
| | 4.84 dB (Antenna Polarize: H) |
| Uncertainty for Radiation Emission Test (1 GHz - 40 GHz) | 4.10 dB (1 - 6 GHz) |
| | 4.40 dB (6 GHz - 18 GHz) |
| | 3.54 dB (18 GHz - 26 GHz) |
| | 4.30 dB (26 GHz - 40 GHz) |
| Uncertainty for Power Line Conduction Emission Test | 3.32 dB (150 kHz - 30 MHz) |

Note: This uncertainty represents an expanded uncertainty expressed at approximately the 95% confidence level using a coverage factor of k=2.

3. Equipment Used During Test

| Equipment | Manufacturer | Model No. | Serial No. | Last Cal. | Cal. Interval |
|--|--------------|-----------------|-------------------|---------------|---------------|
| RF Connected Test (Tonscend RF Measurement System 1#) | | | | | |
| Spectrum analyzer | R&S | FSU26 | 101272 | Jul. 01, 2020 | 1 Year |
| Spectrum analyzer | Agilent | N9020D | MY49100362 | Sep. 28, 2020 | 1 Year |
| Wideband Radio Communication tester | R&S | CMW500 | 117491 | Jul. 01, 2020 | 1 Year |
| Vector Signal Generator | Agilent | E8267D | US49060192 | Sep. 24, 2020 | 1 Year |
| Vector Signal Generator | Agilent | N5182A | MY48180737 | Jul. 01, 2020 | 1 Year |
| Power Sensor | Agilent | U2021XA | MY55150010 | Jul. 01, 2020 | 1 Year |
| Power Sensor | Agilent | U2021XA | MY55150011 | Jul. 01, 2020 | 1 Year |
| DC Power Source | MATRIS | MPS-3005L-3 | D813058W | Apr. 25, 2020 | 1 Year |
| RF Cable | Micable | C10-01-01-1 | 100309 | Sep. 28, 2020 | 1 Year |
| Temp&Humi Programmable | ZHIXIANG | ZXGDJS-150L | ZX170110-A | Jul. 01, 2020 | 1 Year |
| Test Software | JS Tonscend | JS1120-3 | Ver.2.7 | N/A | N/A |
| RF Connected Test (Tonscend RF Measurement System 2#) | | | | | |
| Spectrum analyzer | R&S | FSU26 | 200071 | Sep. 25, 2020 | 1 Year |
| Spectrum analyzer | Agilent | N9020D | MY49100362 | Sep. 28, 2020 | 1 Year |
| Wideband Radio Communication tester | R&S | CMW500 | 117491 | Jul. 01, 2020 | 1 Year |
| Vector Signal Generator | Agilent | N5182A | MY19060405 | Jul. 01, 2020 | 1 Year |
| Vector Signal Generator | Agilent | N5182A | MY48180912 | Jul. 01, 2020 | 1 Year |
| RF Control Unit | Tonsend | JS0806-2 | DDT-ZC01449 | Jul. 01, 2020 | 1 Year |
| DC Power Source | MATRIS | MPS-3005L-3 | D813058W | Apr. 25, 2020 | 1 Year |
| RF Cable | Micable | C10-01-01-1 | 100309 | Sep. 28, 2020 | 1 Year |
| Temp&Humi Programmable | ZHIXIANG | ZXGDJS-150L | ZX170110-A | Jul. 01, 2020 | 1 Year |
| Test Software | JS Tonscend | JS1120-3 | Ver.2.7 | N/A | N/A |
| Radiation 1#chamber | | | | | |
| EMI Test Receiver | R&S | ESU8 | 100316 | Sep. 24, 2020 | 1 Year |
| Spectrum analyzer | Agilent | E4447A | MY50180031 | Jul. 01, 2020 | 1 Year |
| Trilog Broadband Antenna | Schwarzbeck | VULB9163 | 9163-462 | Nov. 13, 2020 | 1 Year |
| Active Loop antenna | Schwarzbeck | FMZB-1519 | 1519-038 | Nov. 13, 2020 | 1 Year |
| Double Ridged Horn Antenna | R&S | HF907 | 100276 | Nov. 18, 2020 | 1 Year |
| Broad Band Horn Antenna | Schwarzbeck | BBHA 9170 | 790 | Apr. 11, 2020 | 1 Year |
| Pre-amplifier | A.H. | PAM-0118 | 360 | Sep. 28, 2020 | 1 Year |
| RF Cable | HUBSER | CP-X2+ CP-X1 | W11.03+ W12.02 | Sep. 24, 2020 | 1 Year |

| | | | | | |
|---|-------------|------------------|----------------------|---------------|--------|
| RF Cable | N/A | 5m+6m+1m | 06270619 | Sep. 30, 2020 | 1 Year |
| MI Cable | HUBSER | C10-01-01-1 M | 1091629 | Sep. 30, 2020 | 1 Year |
| Test software | Audix | E3 | V 6.11111b | N/A | N/A |
| Radiation 2#chamber | | | | | |
| EMI Test Receiver | R&S | ESCI | 101364 | Sep. 28, 2020 | 1 Year |
| Spectrum analyzer | Agilent | E4447A | MY50180031 | Jul. 01, 2020 | 1 Year |
| Trilog Broadband Antenna | Schwarzbeck | VULB 9163 | 9163-994 | Nov. 13, 2020 | 1 Year |
| Active Loop antenna | Schwarzbeck | FMZB-1519 | 1519-038 | Nov. 13, 2020 | 1 Year |
| Double Ridged Horn Antenna | Schwarzbeck | BBHA9120 | 02108 | Jul. 11, 2020 | 1 Year |
| Broad Band Horn Antenna | Schwarzbeck | BBHA 9170 | 790 | Apr. 11, 2020 | 1 Year |
| Pre-amplifier | TERA-MW | TRLA-0040 G35 | 1013 03 | Sep. 28, 2020 | 1 Year |
| RF Cable | N/A | 14+1.5m | 06270619 | Sep. 28, 2020 | 1 Year |
| Test software | Audix | E3 | V 6.11111b | N/A | N/A |
| Power Line Conducted Emissions Test 1# | | | | | |
| EMI Test Receiver | R&S | ESU8 | 100316 | Sep. 24, 2020 | 1 Year |
| LISN 1 | R&S | ENV216 | 101109 | Sep. 28, 2020 | 1 Year |
| LISN 2 | R&S | ESH2-Z5 | 100309 | Sep. 28, 2020 | 1 Year |
| Pulse Limiter | R&S | ESH3-Z2 | 101242 | Sep. 24, 2020 | 1 Year |
| CE Cable 1 | HUBSER | N/A | W10.01 | Sep. 24, 2020 | 1 Year |
| Test software | Audix | E3 | V 6.11111b | N/A | N/A |
| Power Line Conducted Emissions Test 2# | | | | | |
| Test Receiver | R&S | ESPI | 101761 | Sep. 24, 2020 | 1 Year |
| LISN 1 | R&S | ENV216 | 101170 | Sep. 28, 2020 | 1 Year |
| LISN 2 | R&S | ESH2-Z5 | 100309 | Sep. 28, 2020 | 1 Year |
| Pulse Limiter | R&S | KH43101 | 43101180156 8-12# | Jul. 01, 2020 | 1 Year |
| CE Cable 2 | HUBSER | N/A | W11.02 | Sep. 24, 2020 | 1 Year |
| Test software | Audix | E3 | V 6.11111b | N/A | N/A |

4. Maximum Peak Output Power

4.1. Block diagram of test setup

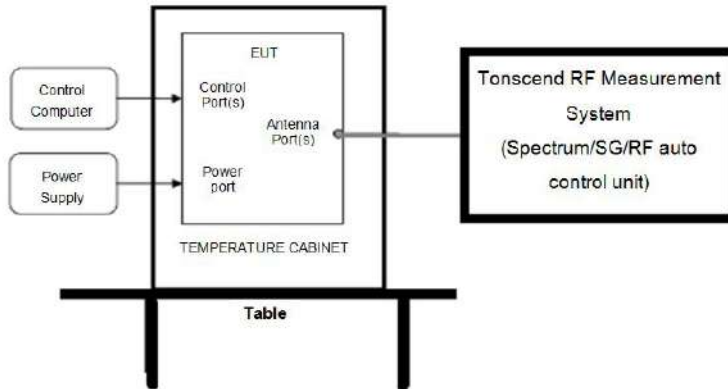

4.2. Limits

For frequency hopping systems operating in the 2400 - 2483.5 MHz band employing at least 75 non-overlapping hopping channels, and all frequency hopping systems in the 5725 - 5850 MHz band: 1 watt. For all other frequency hopping systems in the 2400 - 2483.5 MHz band: 0.125 watts, the e.i.r.p shall not exceed 4 W.

4.3. Test procedure

- (1) Connect EUT's antenna output to spectrum analyzer by RF cable.
- (2) Measure the maximum output power of EUT by spectrum analyzer with PK detector and RBW = 3 MHz (above 20 dB bandwidth of measured signal), VBW = 10 MHz

Note: The attenuator loss was inputted into spectrum analyzer as amplitude offset.

4.4. Test result

| Mode | Antenna | Freq. (MHz) | Result (dBm) | Limit (dBm) | Verdict |
|----------------|---------|-------------|--------------|-------------|---------|
| GFSK | ANT1 | 2402 | -2.24 | 21 | Pass |
| | ANT1 | 2441 | -2.20 | 21 | Pass |
| | ANT1 | 2480 | -2.58 | 21 | Pass |
| $\pi/4$ -DQPSK | ANT1 | 2402 | -1.84 | 21 | Pass |
| | ANT1 | 2441 | -1.91 | 21 | Pass |
| | ANT1 | 2480 | -2.07 | 21 | Pass |
| 8DPSK | ANT1 | 2402 | -1.52 | 21 | Pass |
| | ANT1 | 2441 | -1.52 | 21 | Pass |
| | ANT1 | 2480 | -1.73 | 21 | Pass |

4.5. Original test data

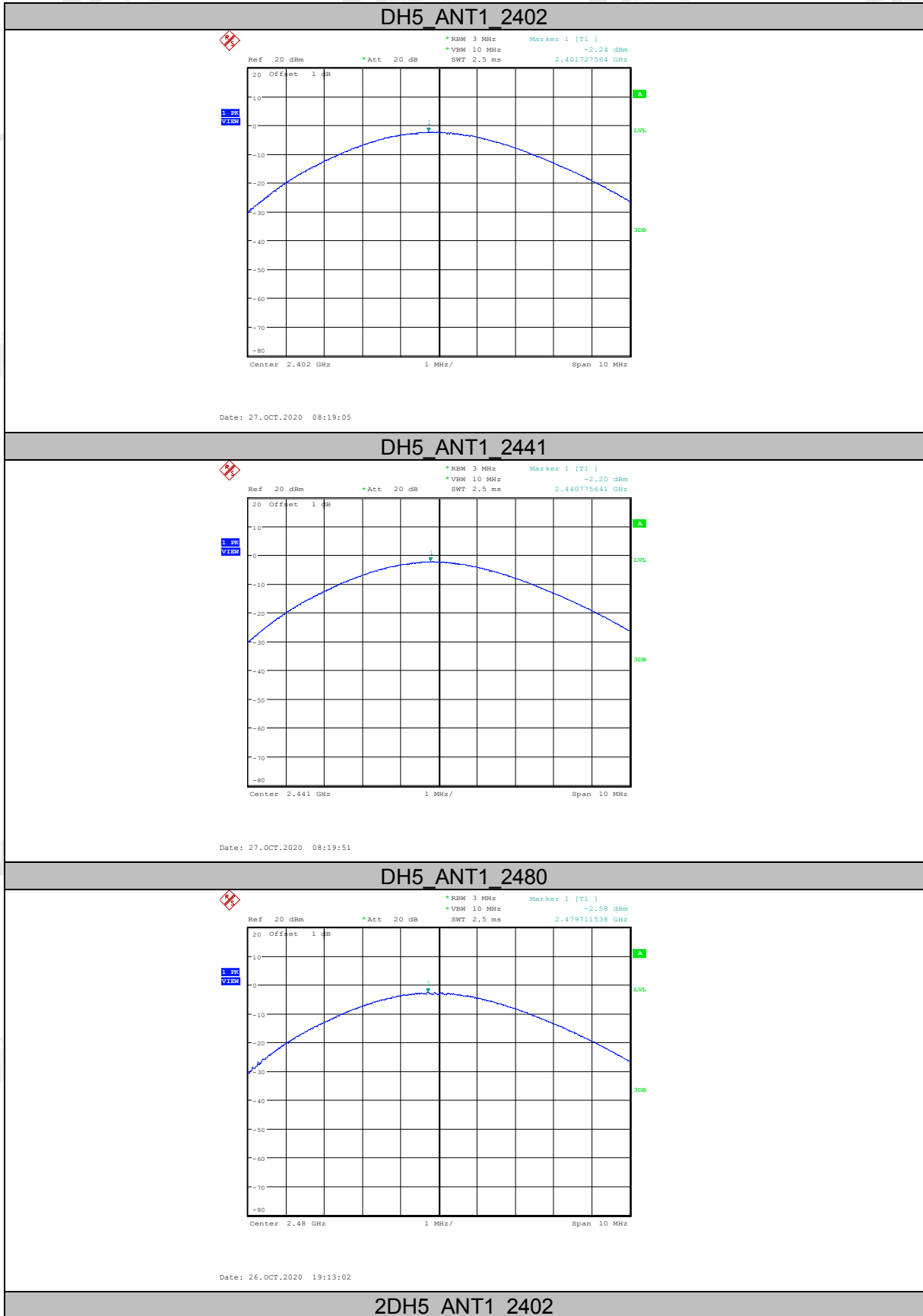

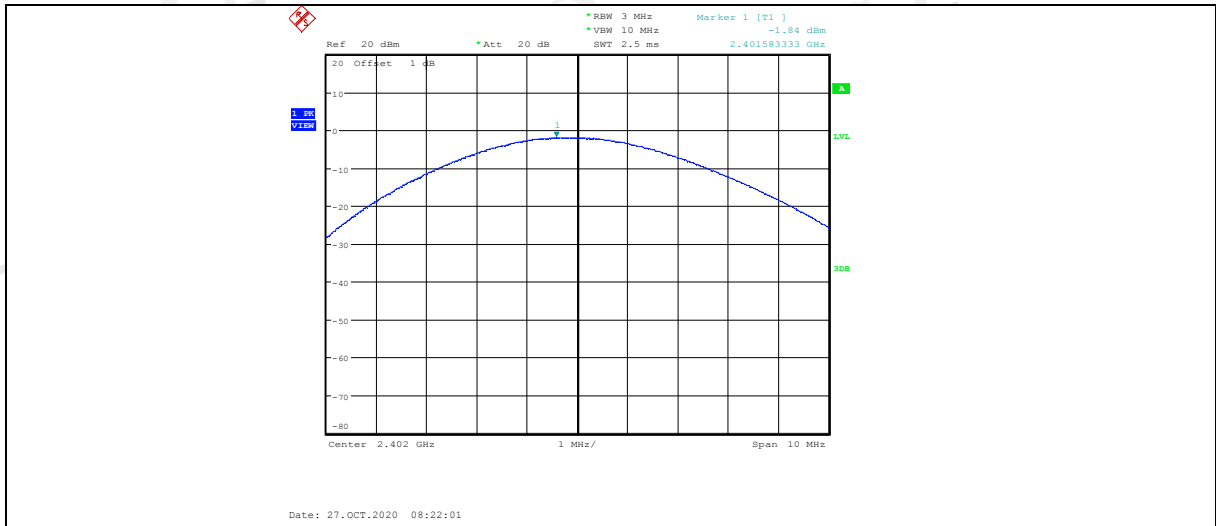

2DH5 ANT1 2441

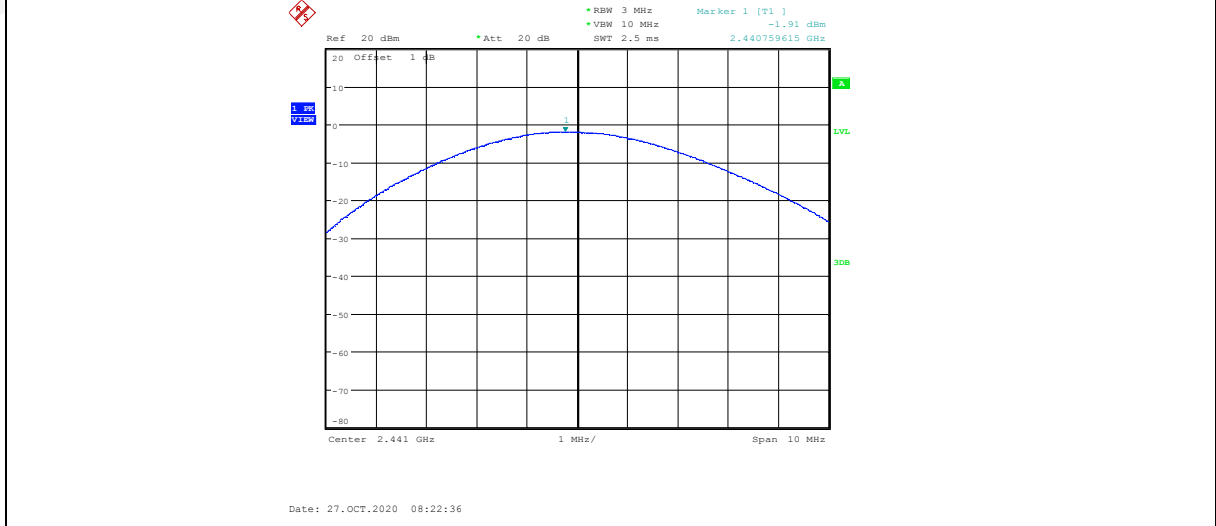

2DH5 ANT1 2480

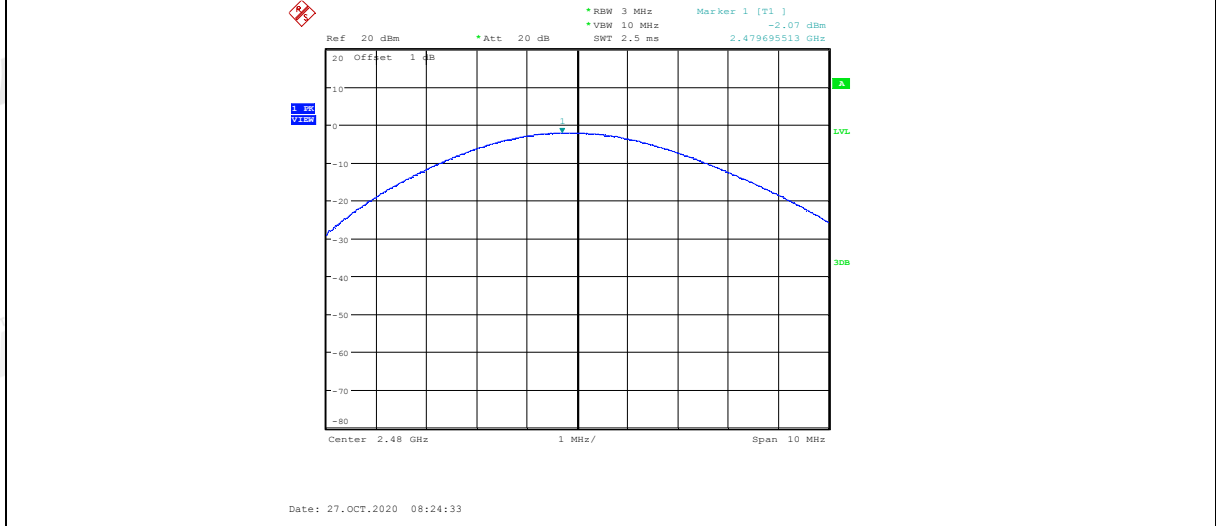

3DH5 ANT1_2402

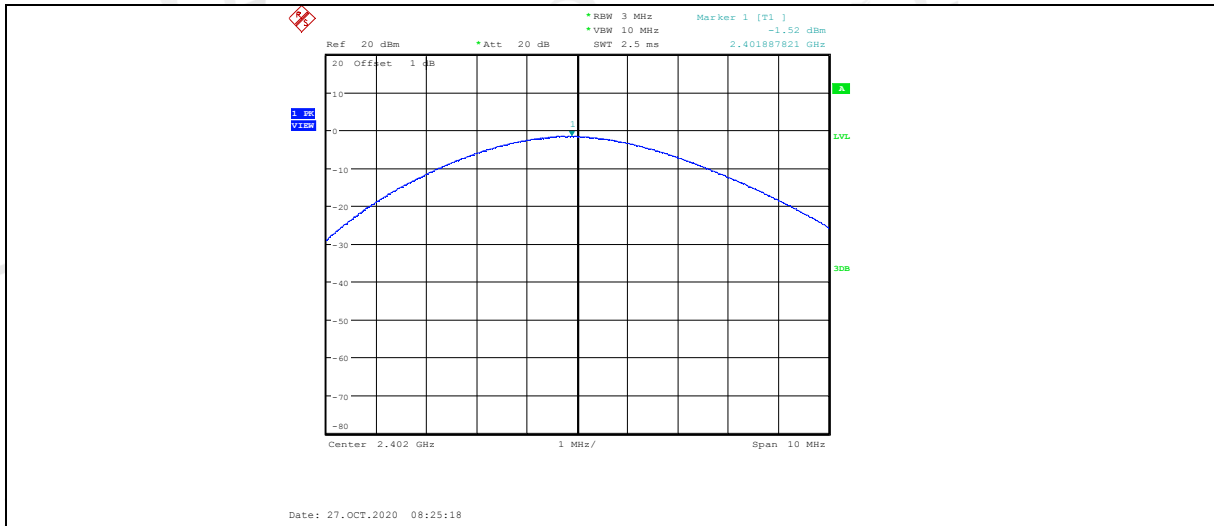

3DH5 ANT1 2441

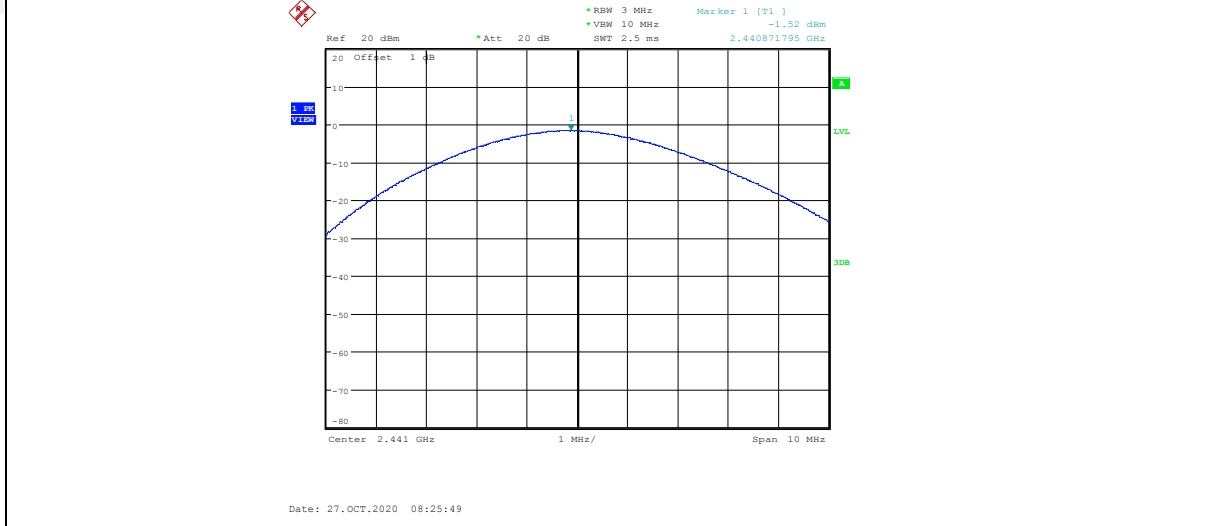

3DH5 ANT1 2480

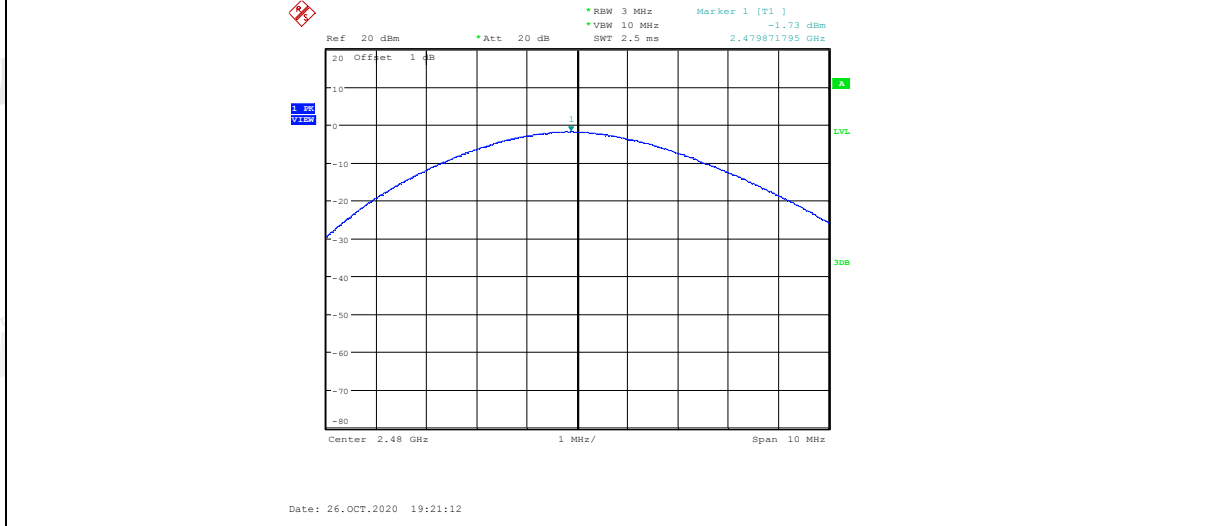

5. 20 dB Bandwidth and 99% Bandwidth

5.1. Block diagram of test setup

Same as section 4.1

5.2. Limits

Intentional radiators operating under the alternative provisions to the general emission limits, as contained in § 15.217 through 15.257 and in Subpart E of this part, must be designed to ensure that the 20 dB bandwidth of the emission, or whatever bandwidth may otherwise be specified in the specific rule section under which the equipment operates, is contained within the frequency band designated in the rule section under which the equipment is operated.

5.3. Test procedure

- (1) Connect EUT's antenna output to spectrum analyzer by RF cable.
- (2) The bandwidth of the fundamental frequency was measured by spectrum analyzer with 100 kHz RBW and 300 kHz VBW. The 20 dB bandwidth is defined as the total spectrum the power of which is higher than peak power minus 20 dB.

5.4. Test result

| Mode | Antenna | Freq. (MHz) | 20 dB bandwidth Result (MHz) | 99% bandwidth Result (MHz) | Verdict |
|----------------|---------|-------------|------------------------------|----------------------------|---------|
| GFSK | ANT1 | 2402 | 0.950 | 0.862 | Pass |
| | ANT1 | 2441 | 0.950 | 0.864 | Pass |
| | ANT1 | 2480 | 0.954 | 0.864 | Pass |
| $\pi/4$ -DQPSK | ANT1 | 2402 | 1.284 | 1.170 | Pass |
| | ANT1 | 2441 | 1.286 | 1.172 | Pass |
| | ANT1 | 2480 | 1.318 | 1.184 | Pass |
| 8DPSK | ANT1 | 2402 | 1.294 | 1.178 | Pass |
| | ANT1 | 2441 | 1.296 | 1.180 | Pass |
| | ANT1 | 2480 | 1.300 | 1.178 | Pass |

5.5. Original test data

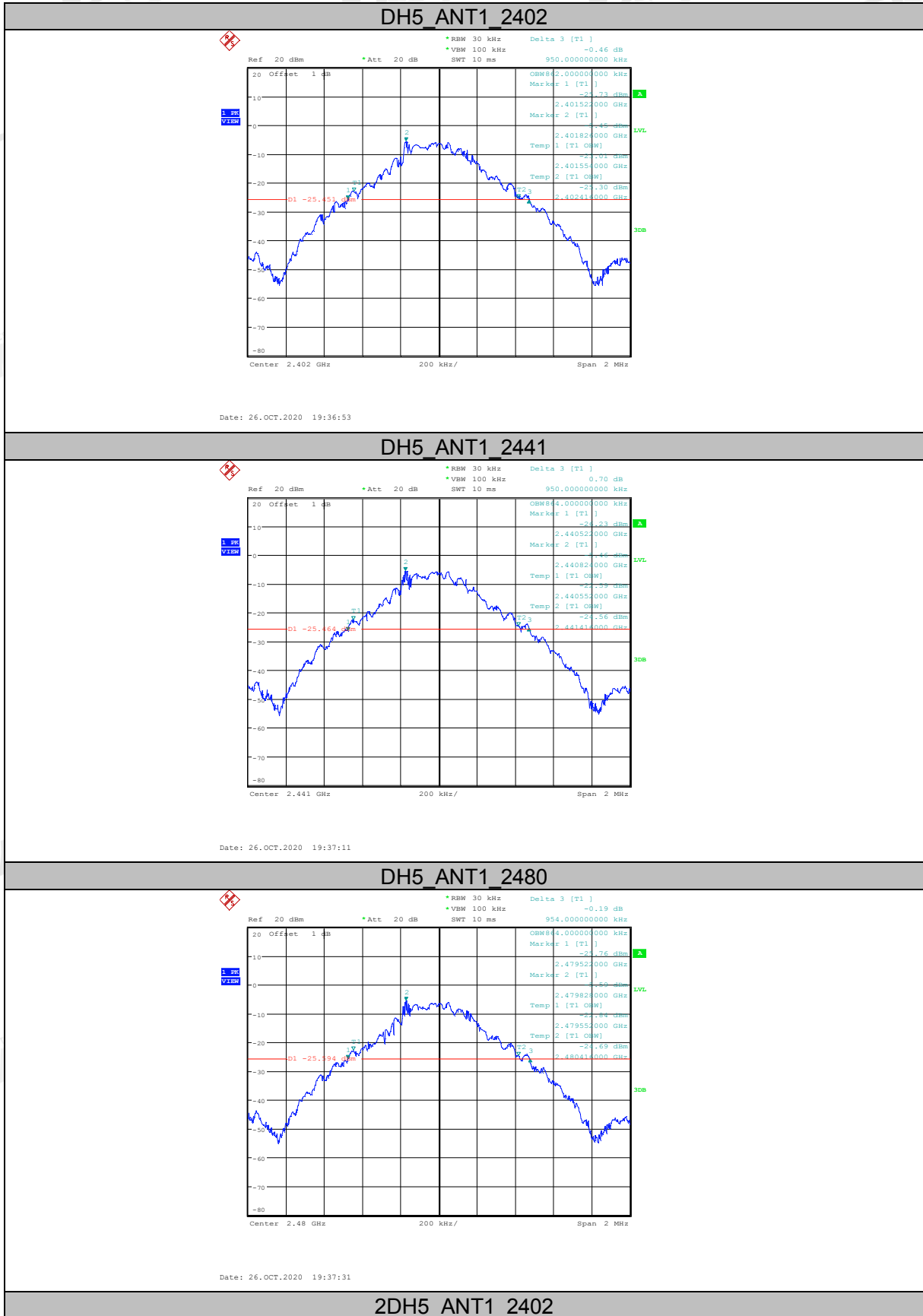

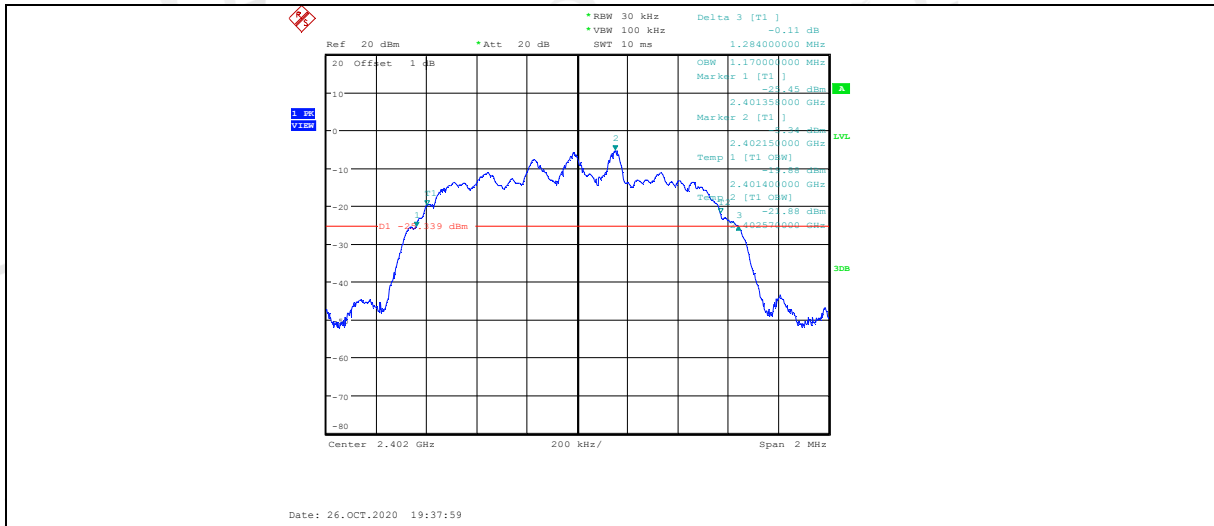

2DH5 ANT1_2441

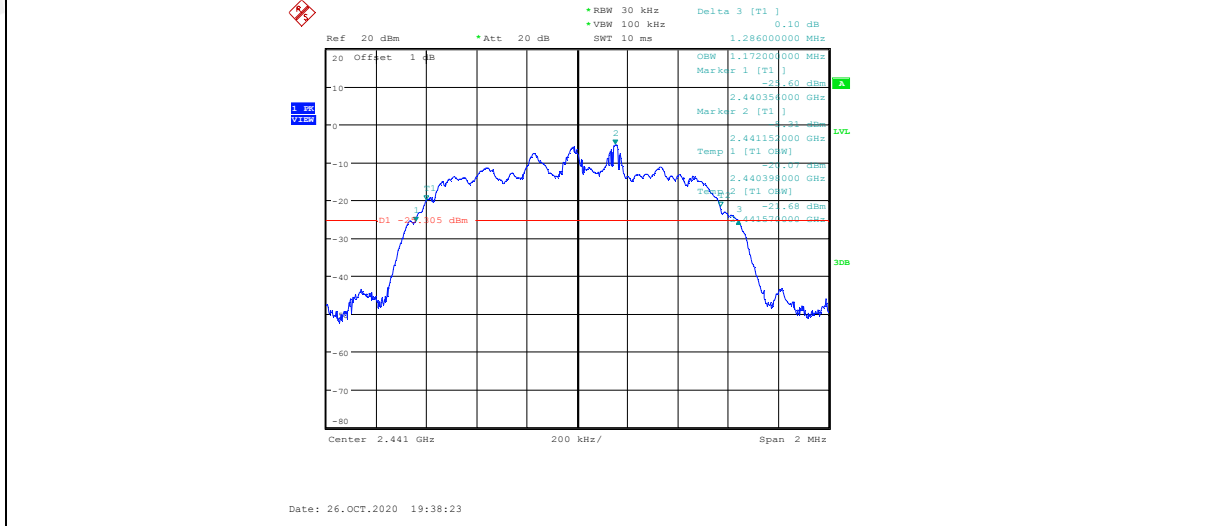

2DH5 ANT1_2480

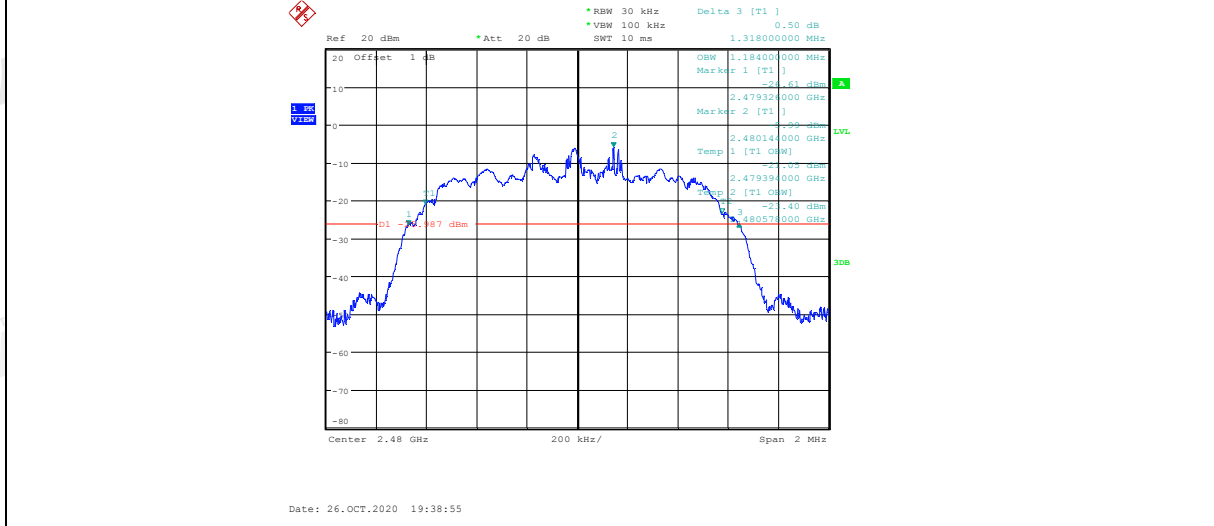

3DH5 ANT1_2402

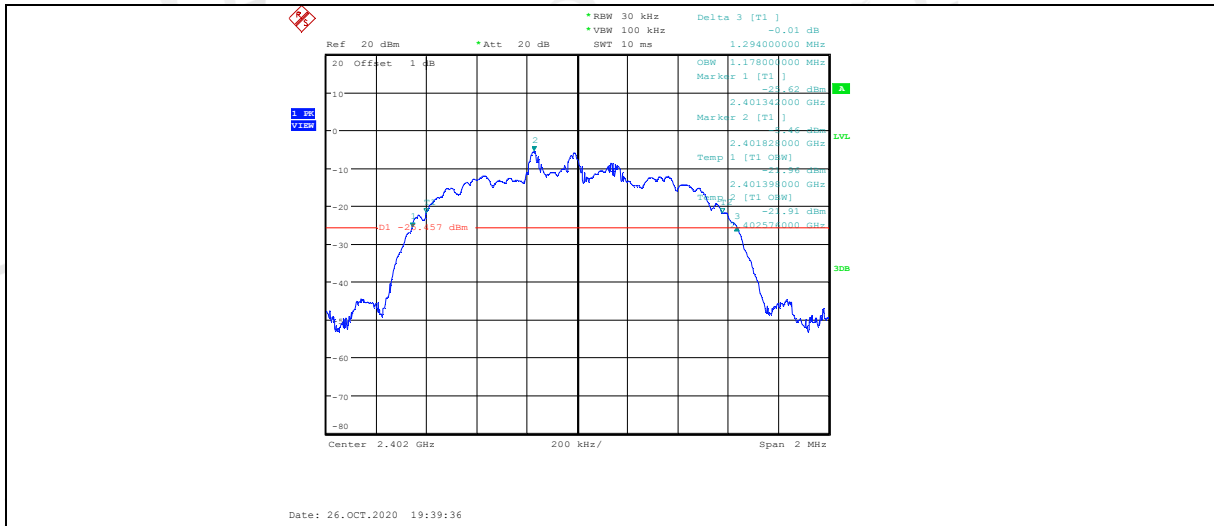

3DH5 ANT1 2441

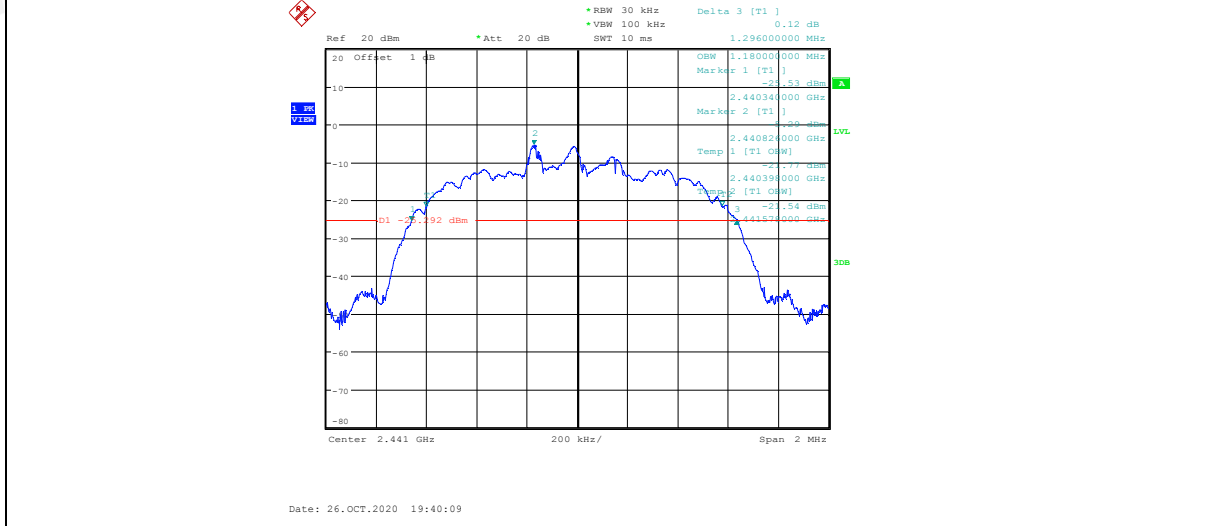

3DH5 ANT1 2480

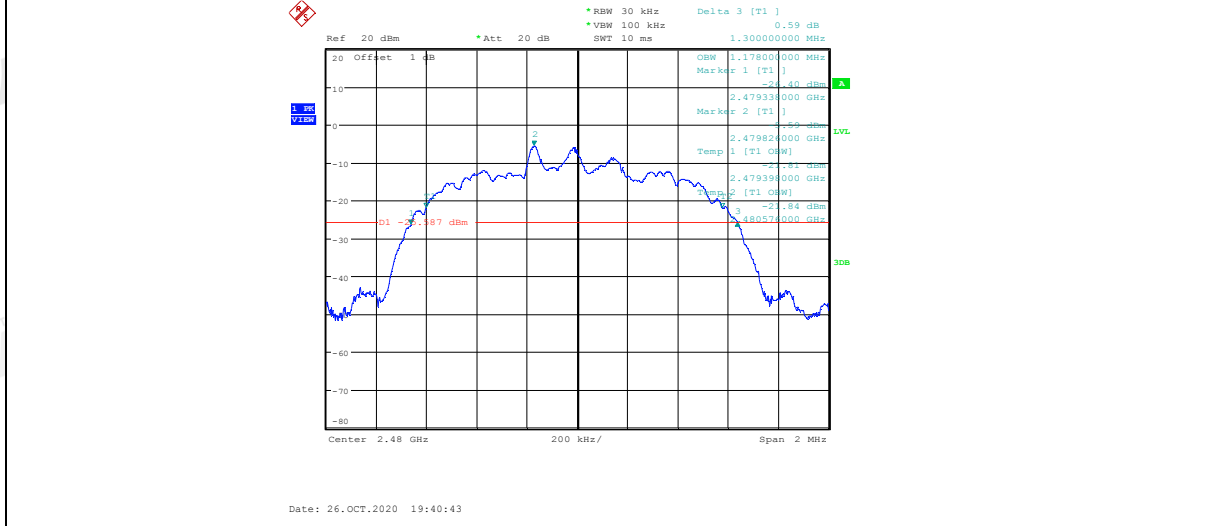

6. Carrier Frequency Separation

6.1. Block diagram of test setup

Same as section 4.1

6.2. Limits

Frequency hopping systems shall have hopping channel carrier frequencies separated by a minimum of 25 kHz or the 20 dB bandwidth of the hopping channel, whichever is greater.

Alternatively, frequency hopping systems operating in the 2400 - 2483.5 MHz band may have hopping channel carrier frequencies that are separated by 25 kHz or two-thirds of the 20 dB bandwidth of the hopping channel, whichever is greater, provided the systems operate with an output power no greater than 125 mW.

6.3. Test procedure

- (1) Connect EUT's antenna output to spectrum analyzer by RF cable.
- (2) The carrier frequency was measured by spectrum analyzer with 100 kHz RBW and 300 kHz VBW.

6.4. Test result

| Mode | Antenna | Channel separation (MHz) | 20 dB bandwidth (MHz) (worse case) | Limit (MHz) 2/3 of 20 dB bandwidth | Verdict |
|----------------|---------|--------------------------|------------------------------------|------------------------------------|---------|
| GFSK | ANT1 | 0.971 | 0.954 | ≥0.636 | Pass |
| $\pi/4$ -DQPSK | ANT1 | 1.122 | 1.318 | ≥0.879 | Pass |
| 8DPSK | ANT1 | 1.003 | 1.300 | ≥0.867 | Pass |

6.5. Original test data

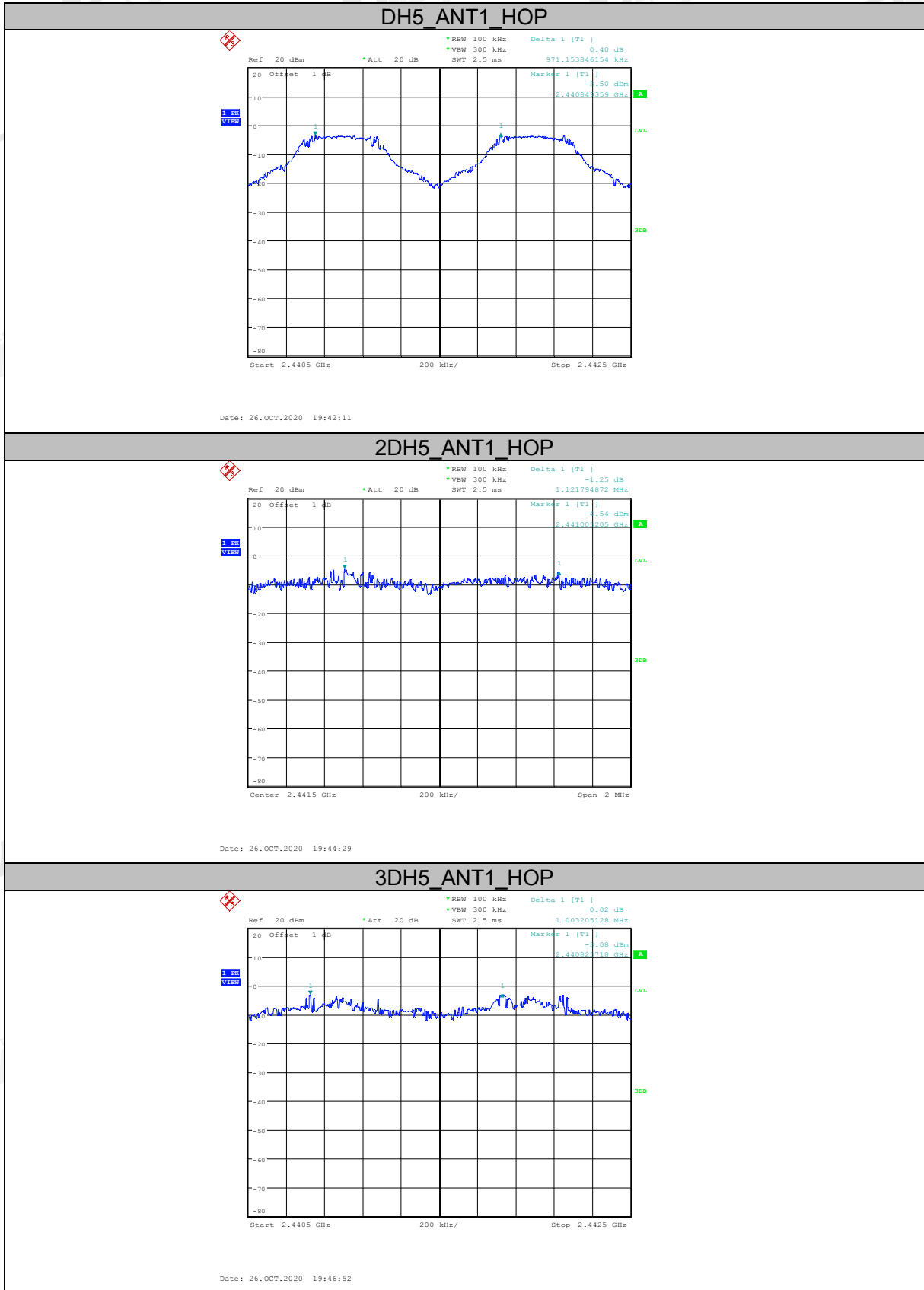

7. Number of Hopping Channel

7.1. Block diagram of test setup

Same as section 4.1

7.2. Limits

Frequency hopping systems in the 2400 - 2483.5 MHz band shall use at least 15 channels.

7.3. Test procedure

- (1) Connect EUT's antenna output to spectrum analyzer by RF cable.
- (2) The number of hopping channels was measured by spectrum analyzer with 100 kHz RBW and 300 kHz VBW.

7.4. Test result

| Mode | Antenna | Number of hopping channels | Limit | Verdict |
|----------------|---------|----------------------------|-------|---------|
| GFSK | ANT1 | 79 | >15 | Pass |
| $\pi/4$ -DQPSK | ANT1 | 79 | >15 | Pass |
| 8DPSK | ANT1 | 79 | >15 | Pass |

7.5. Original test data

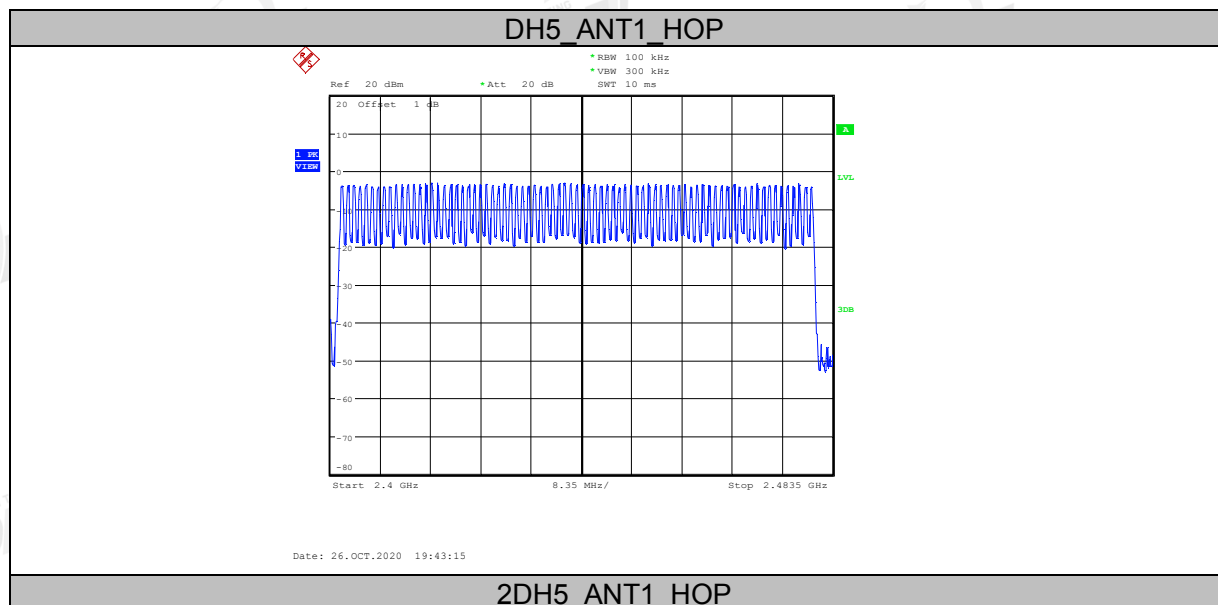

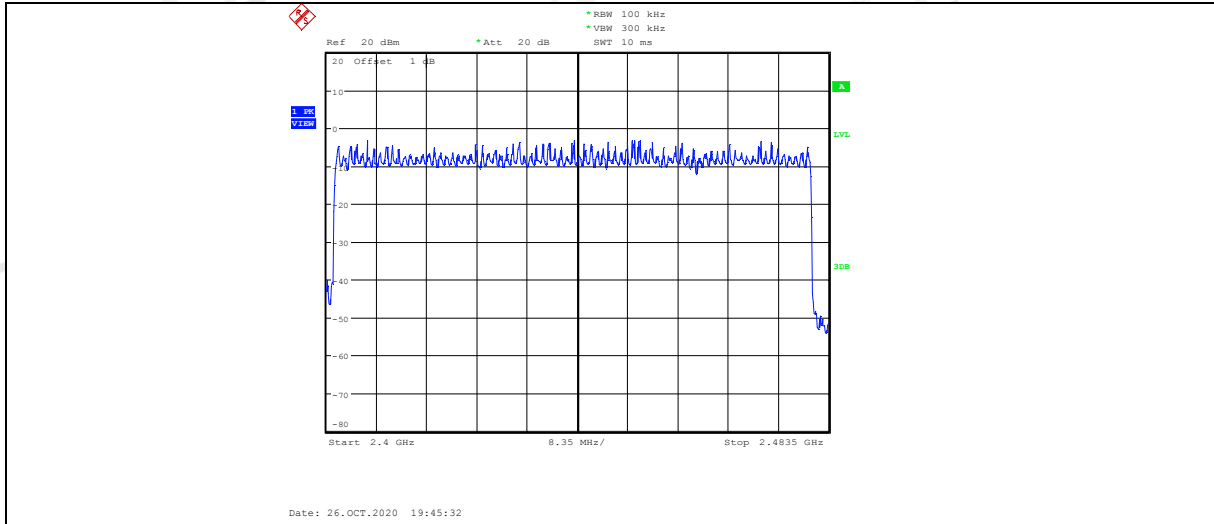

3DH5 ANT1 HOP

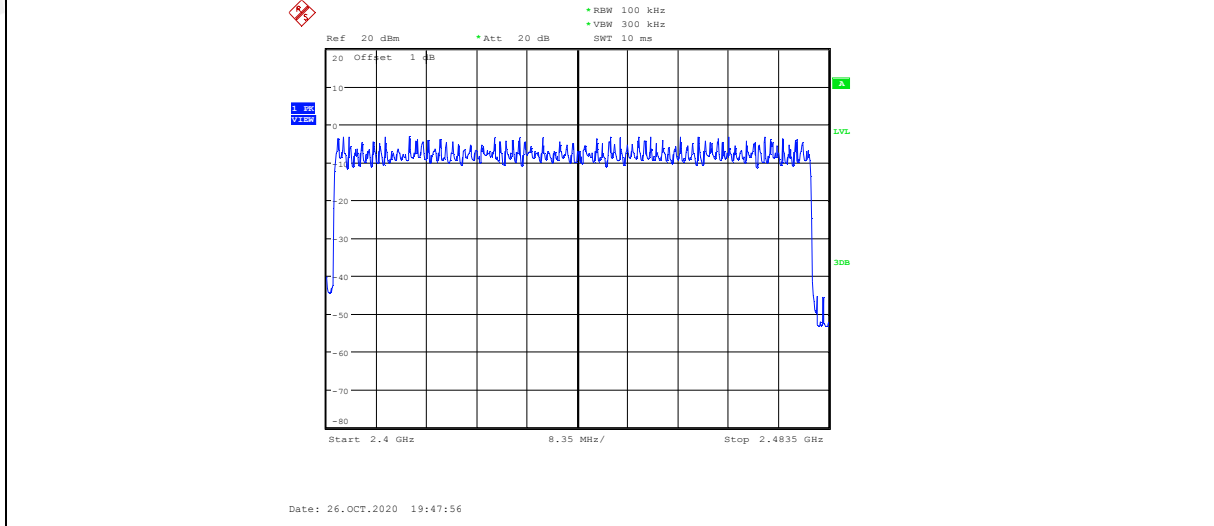

8. Dwell Time

8.1. Block diagram of test setup

Same as section 4.1

8.2. Limits

The average time of occupancy on any channel shall not be greater than 0.4 seconds within a period of 0.4 seconds multiplied by the number of hopping channels employed.

8.3. Test procedure

- (1) Connect EUT's antenna output to spectrum analyzer by RF cable.
- (2) The test period: $T = 0.4 \text{ Second/Channel} \times 79 \text{ Channel} = 31.6 \text{ s}$
- (3) Measure the hopping number and on time of each pulse with spectrum analyzer in zero span set, and calculate dwell time with formula $\text{Dwell time} = \text{total hops} * \text{pulse's on time}$.

8.4. Test result

| Mode | Antenna | Dwell time (s) | Pulse's on time (ms) | Total hops | Limit | Verdict |
|------|---------|----------------|----------------------|------------|----------|---------|
| DH1 | ANT1 | 0.115 | 0.36 | 319 | < 400 ms | Pass |
| DH3 | ANT1 | 0.254 | 1.62 | 157 | < 400 ms | Pass |
| DH5 | ANT1 | 0.298 | 2.87 | 104 | < 400 ms | Pass |
| 2DH1 | ANT1 | 0.117 | 0.37 | 317 | < 400 ms | Pass |
| 2DH3 | ANT1 | 0.259 | 1.62 | 160 | < 400 ms | Pass |
| 2DH5 | ANT1 | 0.307 | 2.87 | 107 | < 400 ms | Pass |
| 3DH1 | ANT1 | 0.118 | 0.37 | 318 | < 400 ms | Pass |
| 3DH3 | ANT1 | 0.245 | 1.62 | 151 | < 400 ms | Pass |
| 3DH5 | ANT1 | 0.328 | 2.88 | 114 | < 400 ms | Pass |

Note: Dwell time = total hops * pulse's on time.

8.5. Original test data

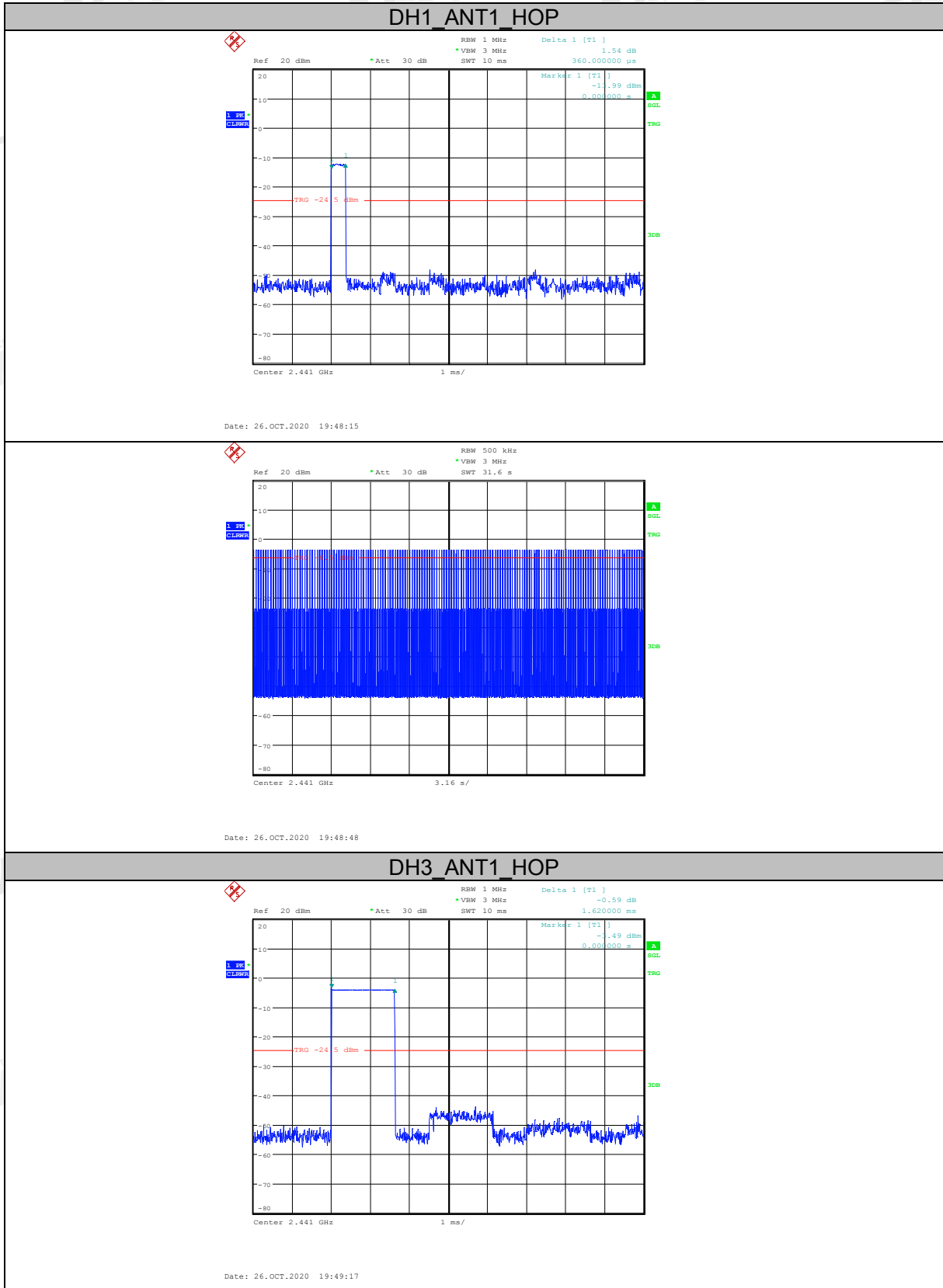

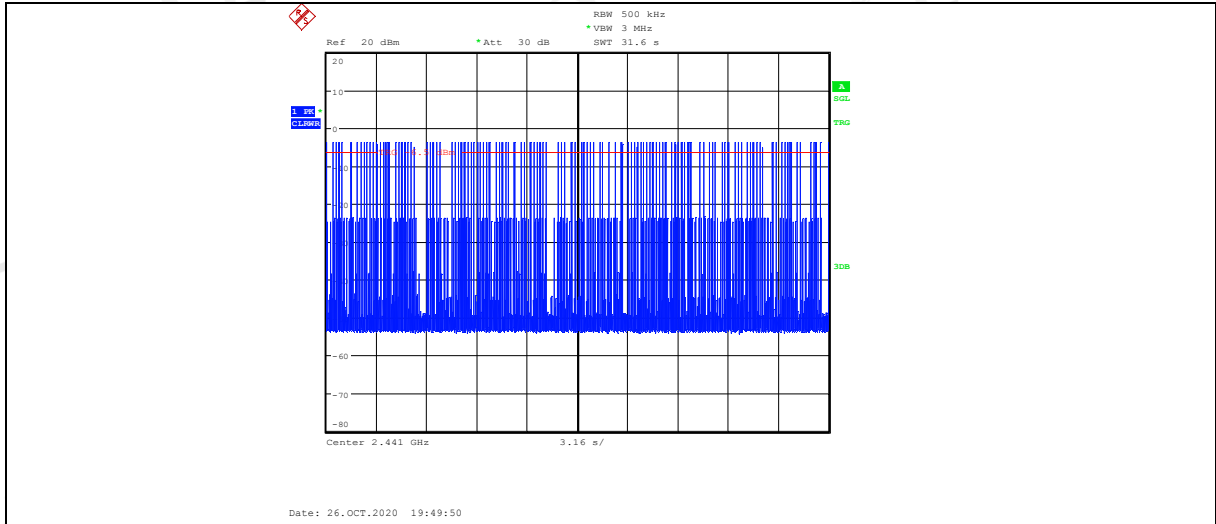

DH5 ANT1 HOP

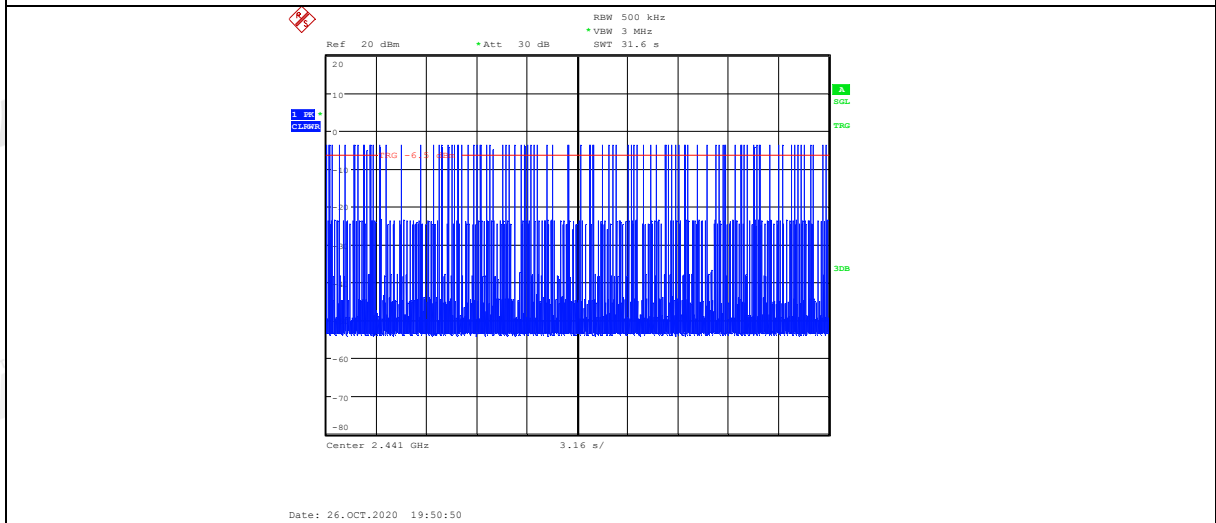
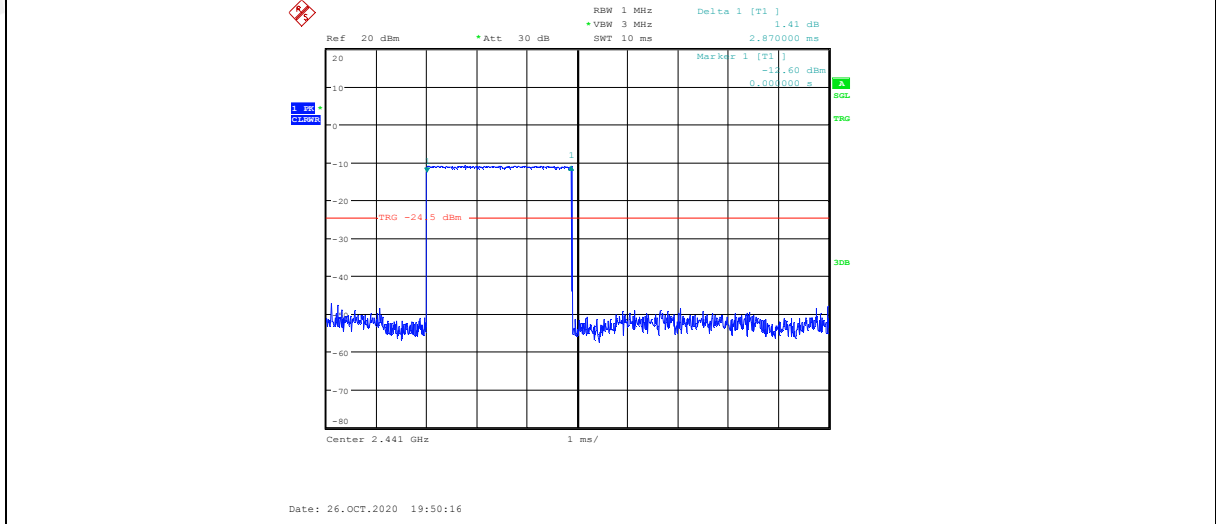

2DH1 ANT1 HOP

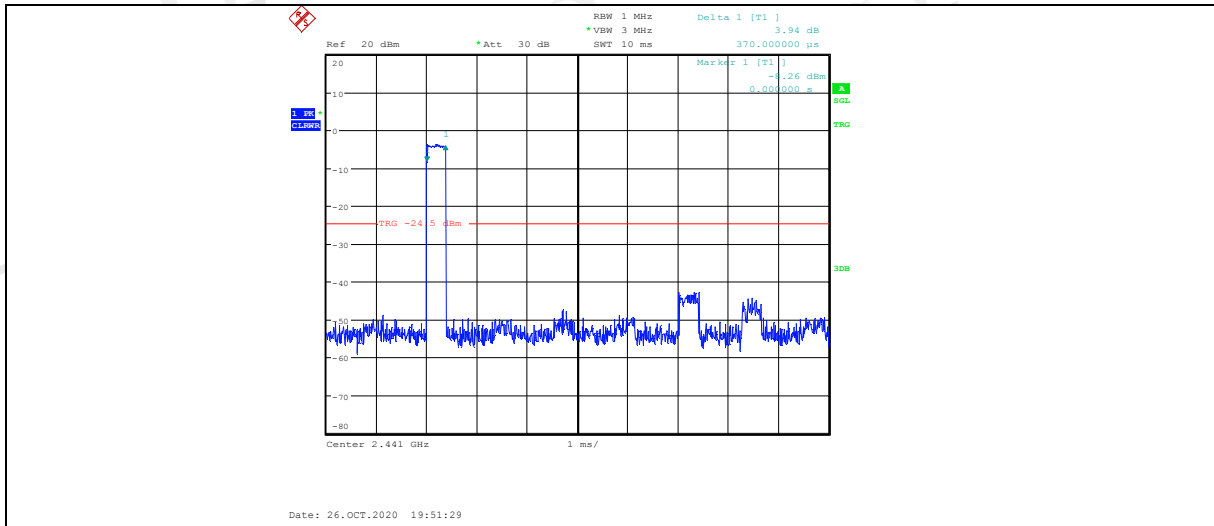

Date: 26.OCT.2020 19:51:29

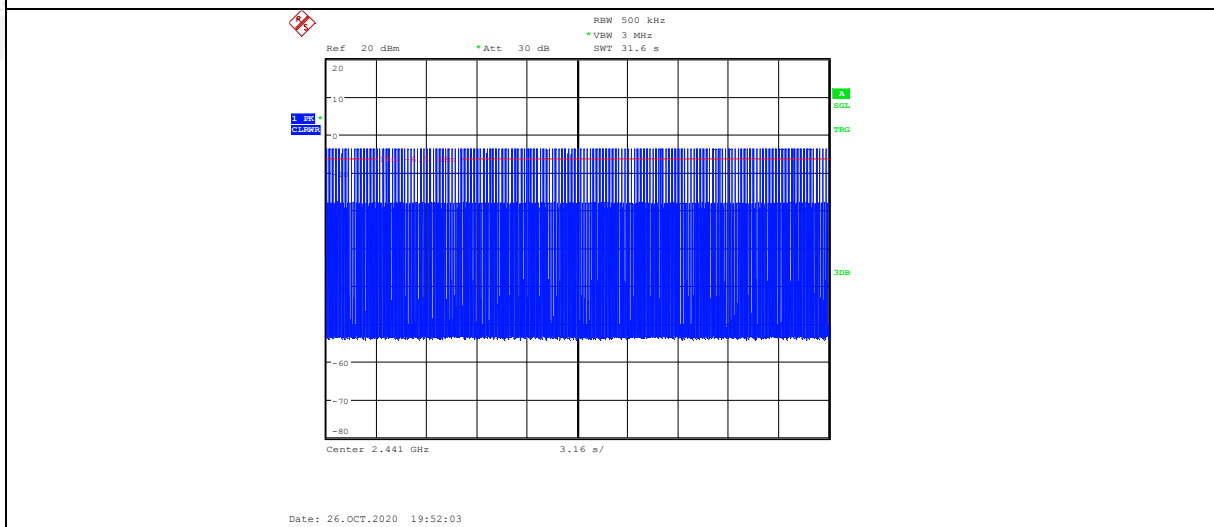

Date: 26.OCT.2020 19:52:03

2DH3 ANT1 HOP

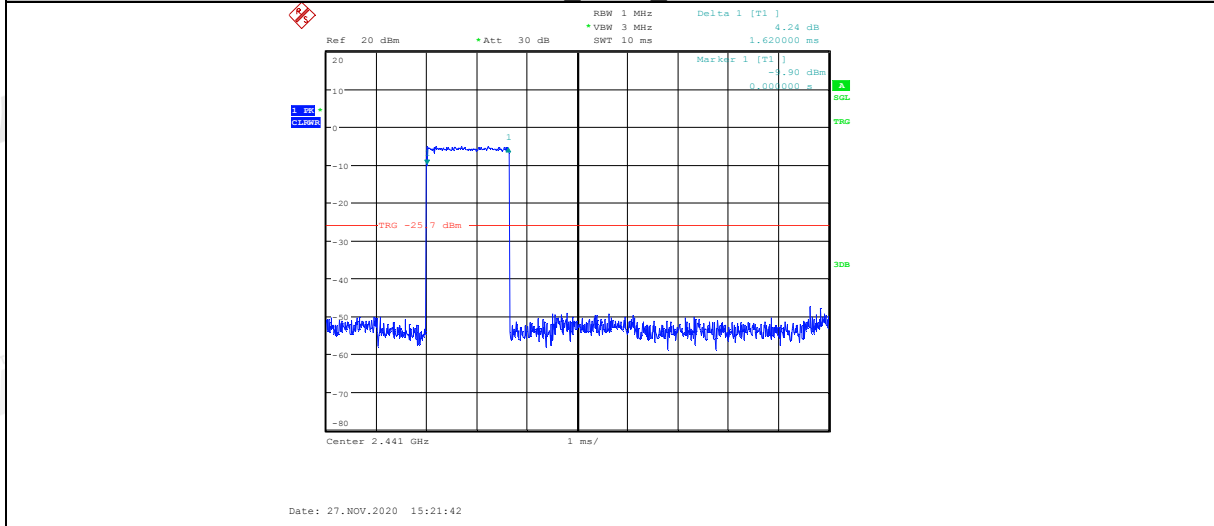

Date: 27.NOV.2020 15:21:42

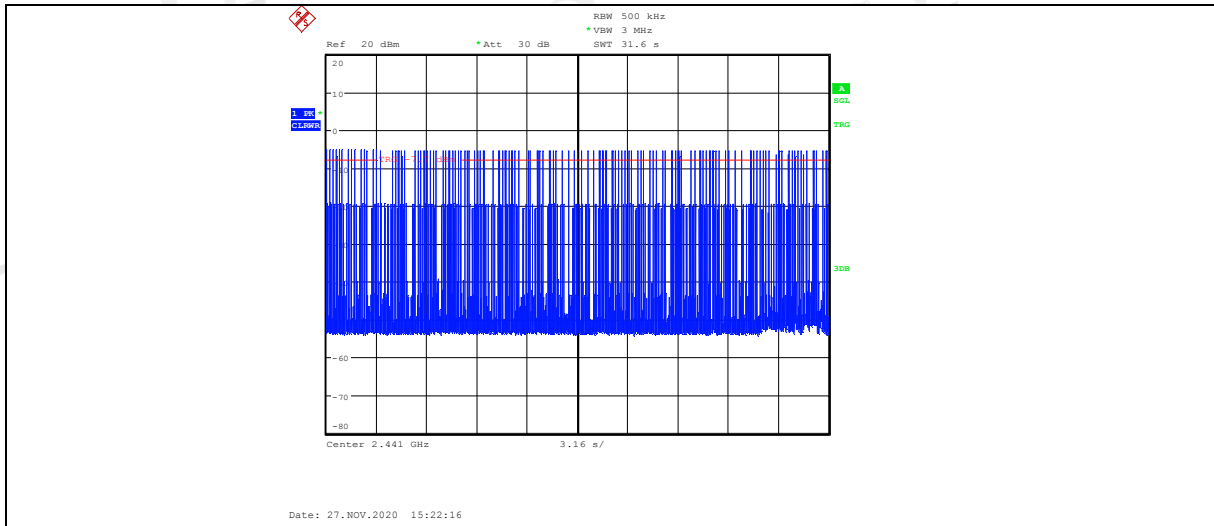

2DH5 ANT1 HOP

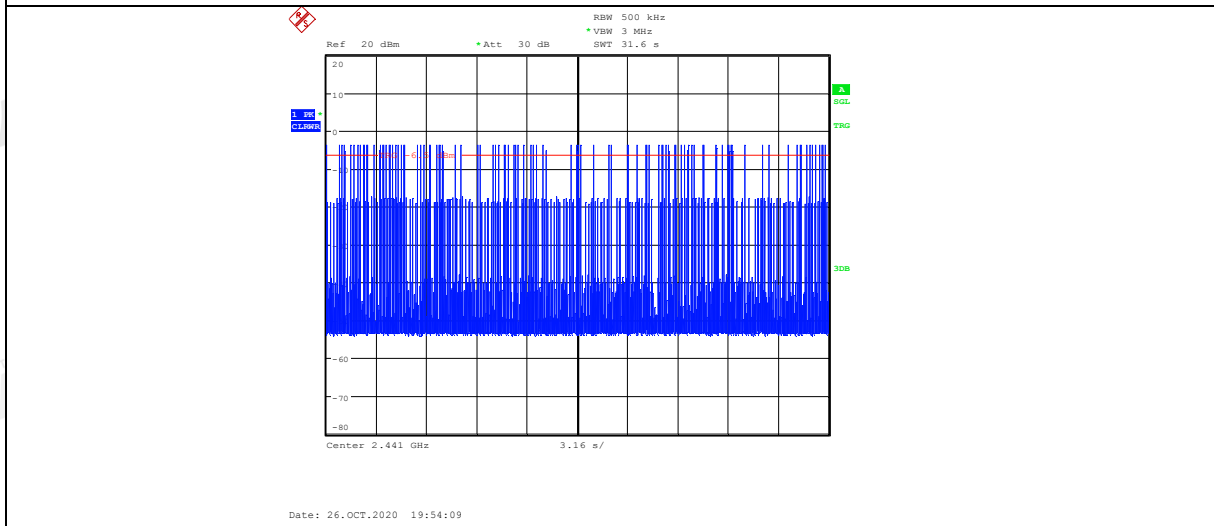
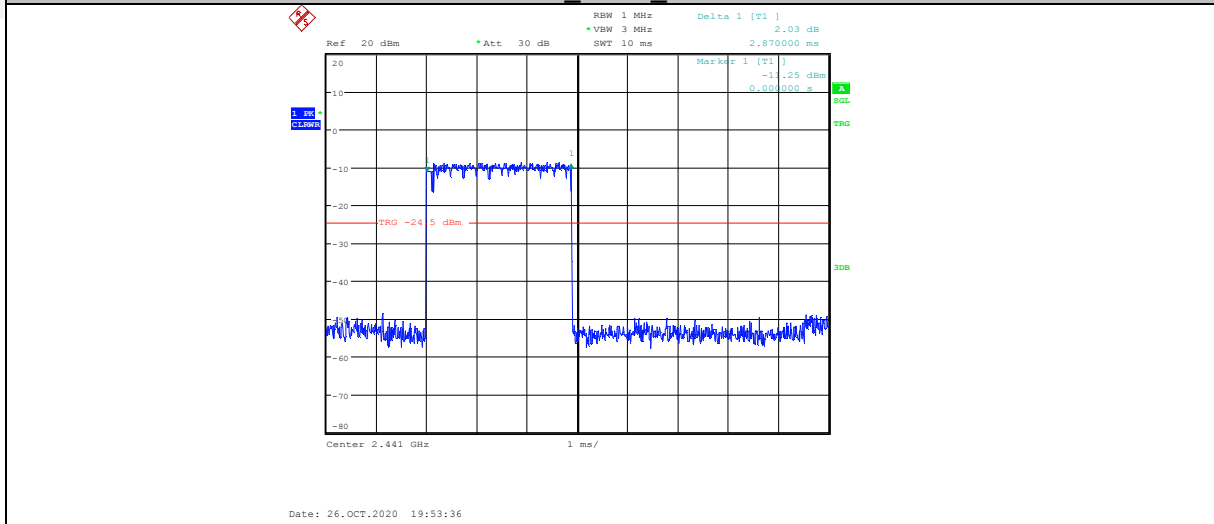

3DH1 ANT1 HOP

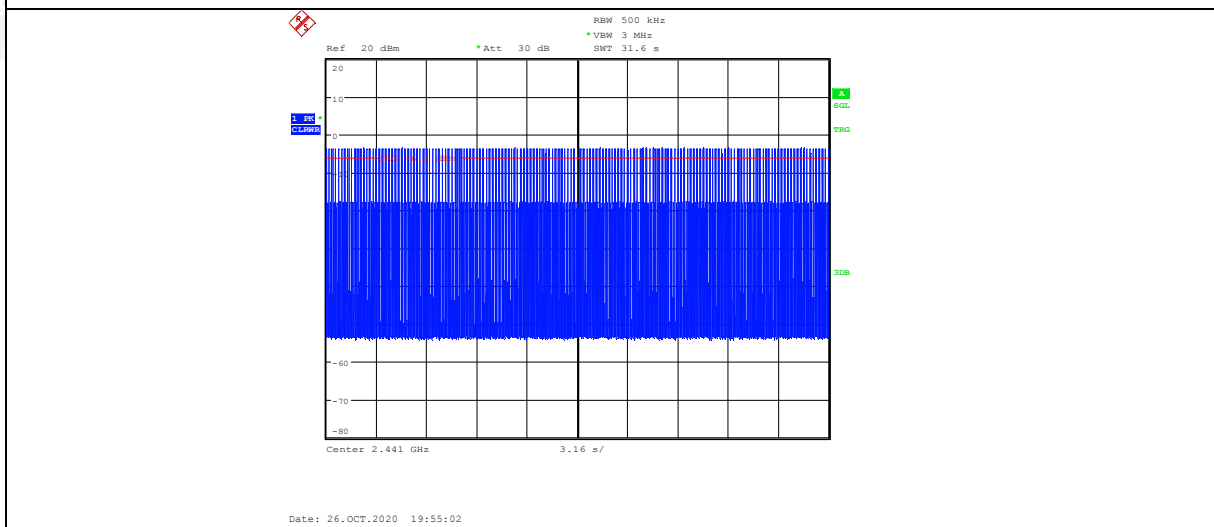
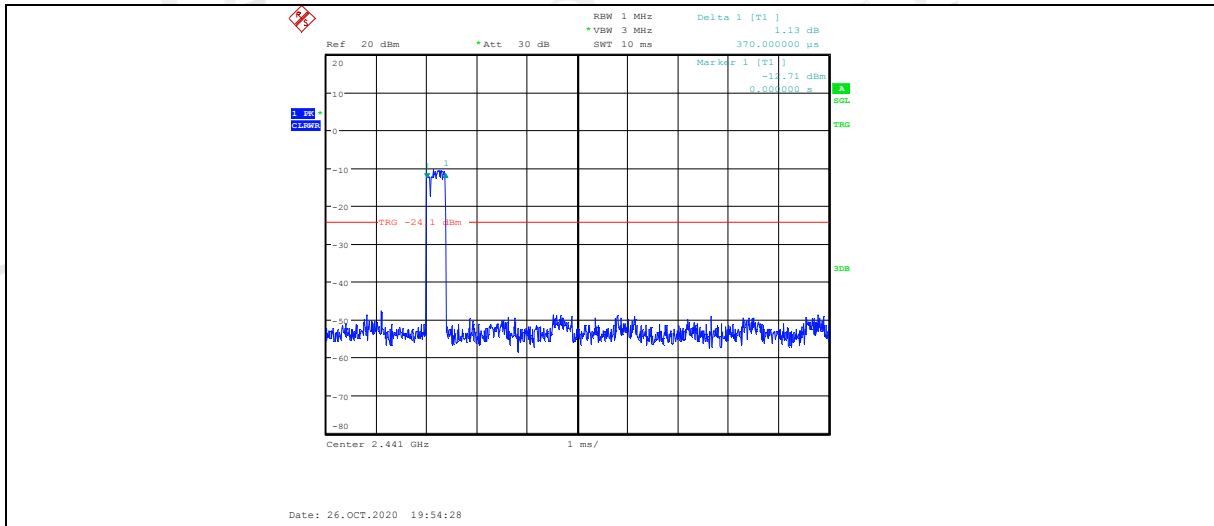

3DH3 ANT1 HOP

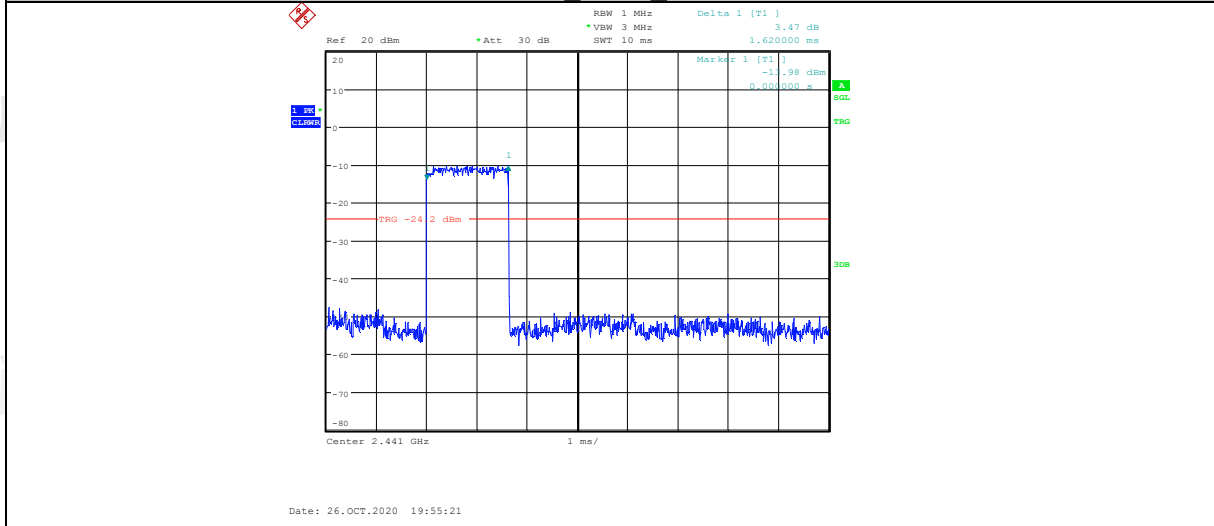

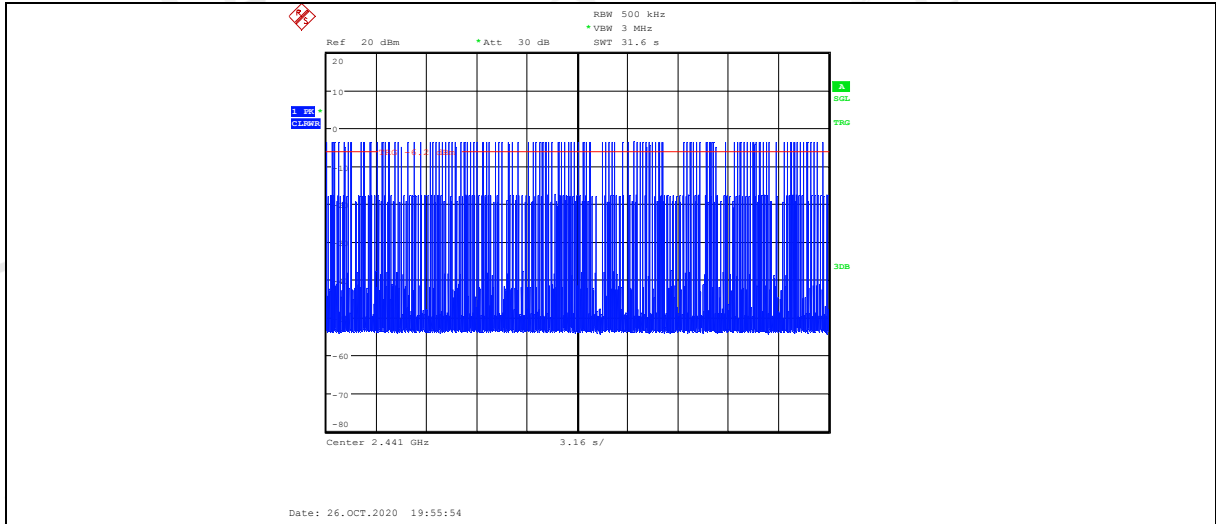

3DH5 ANT1 HOP

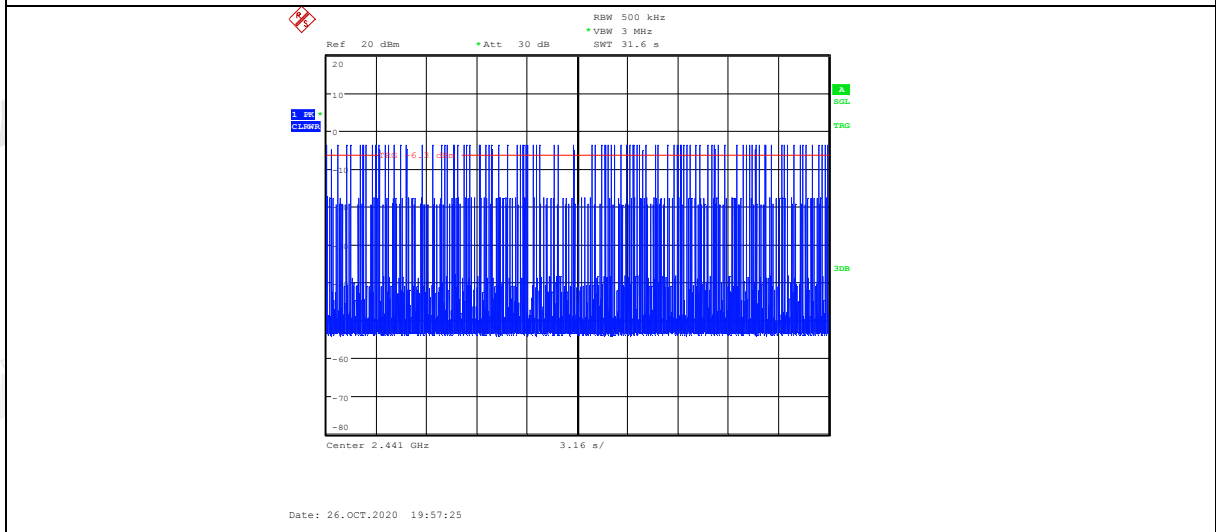
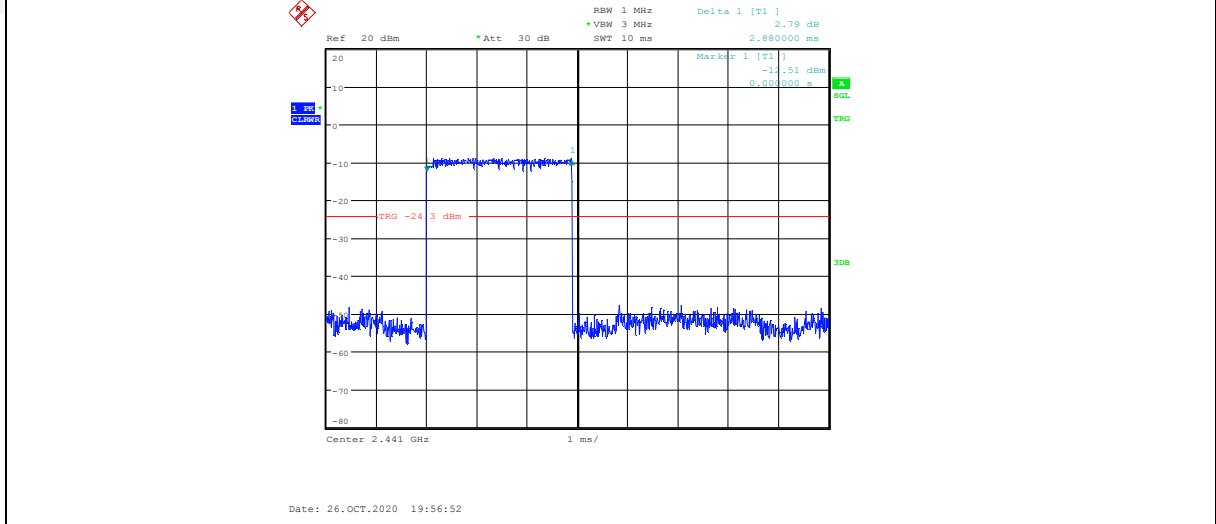

9. Band Edge Compliance (Conducted Method)

9.1. Block diagram of test setup

Same as section 4.1

9.2. Limit

All restriction band should comply with 15.209, other emission should be at least 20 dB below the fundamental.

9.3. Test result

| Mode | Antenna | Freq. (MHz) | Verdict |
|----------------|---------|------------------|---------|
| GFSK | ANT1 | Hopping off 2402 | Pass |
| | ANT1 | Hopping off 2480 | Pass |
| | ANT1 | Hopping on | Pass |
| $\pi/4$ -DQPSK | ANT1 | Hopping off 2402 | Pass |
| | ANT1 | Hopping off 2480 | Pass |
| | ANT1 | Hopping on | Pass |
| 8DPSK | ANT1 | Hopping off 2402 | Pass |
| | ANT1 | Hopping off 2480 | Pass |
| | ANT1 | Hopping on | Pass |

9.4. Original test data

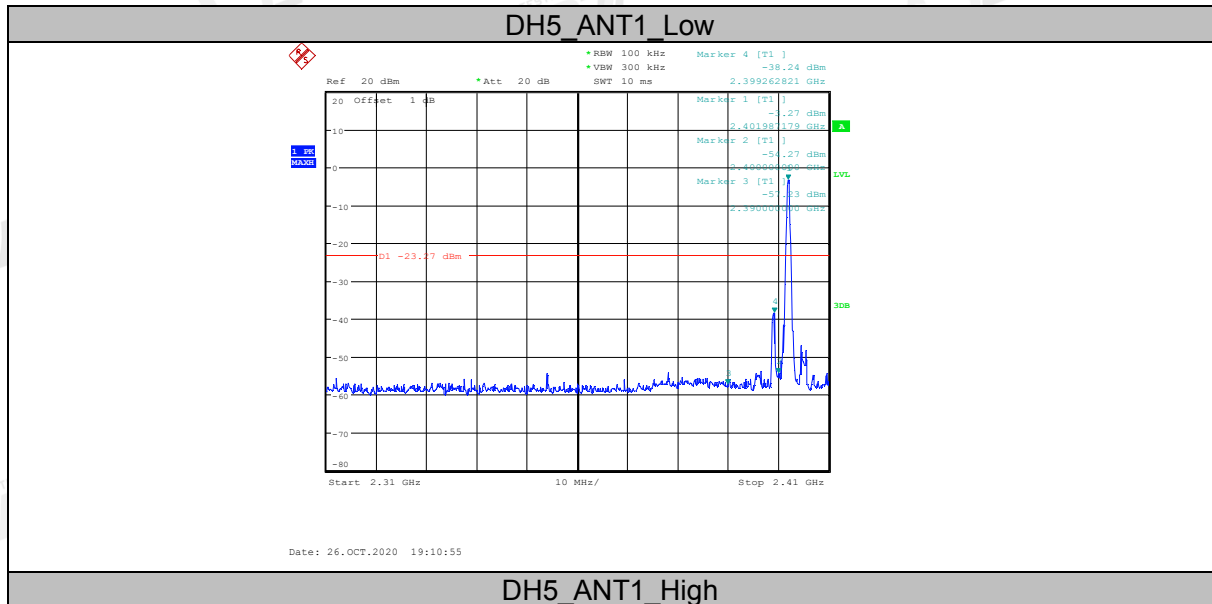

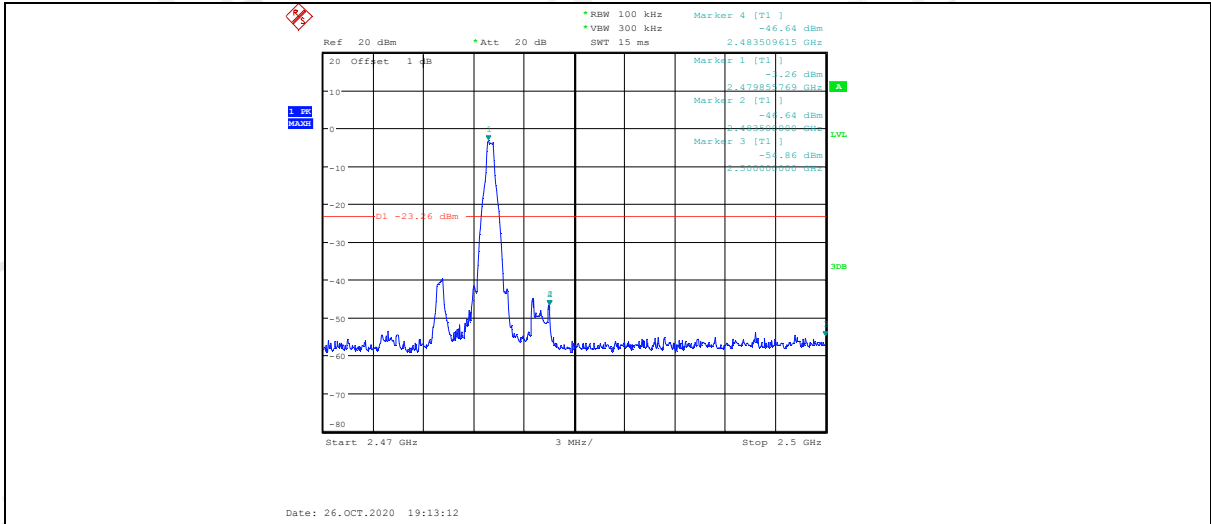

DH5_ANT1_Low

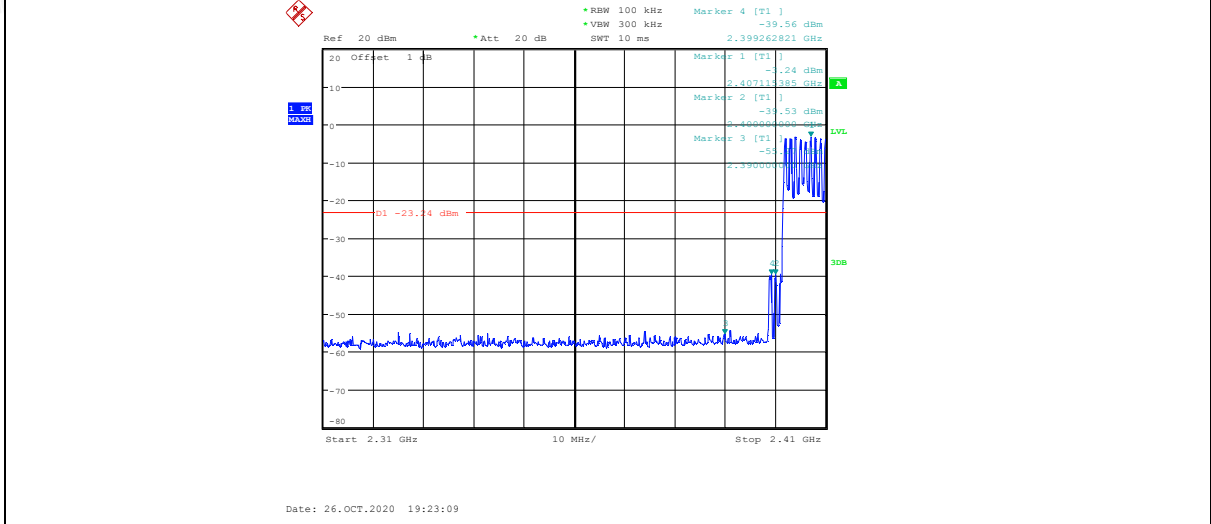

DH5_ANT1_High

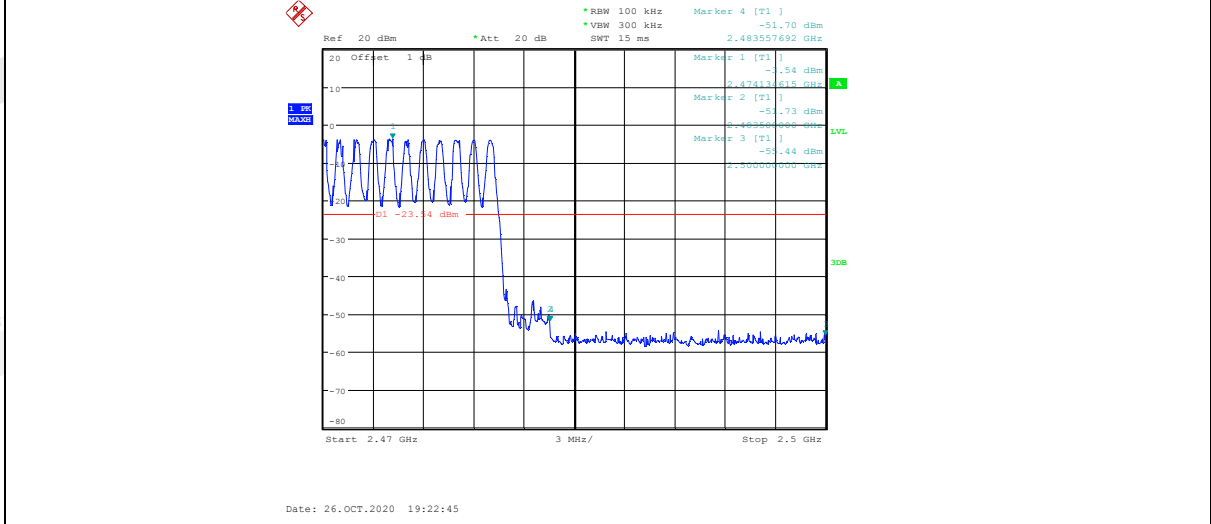

2DH5_ANT1_Low

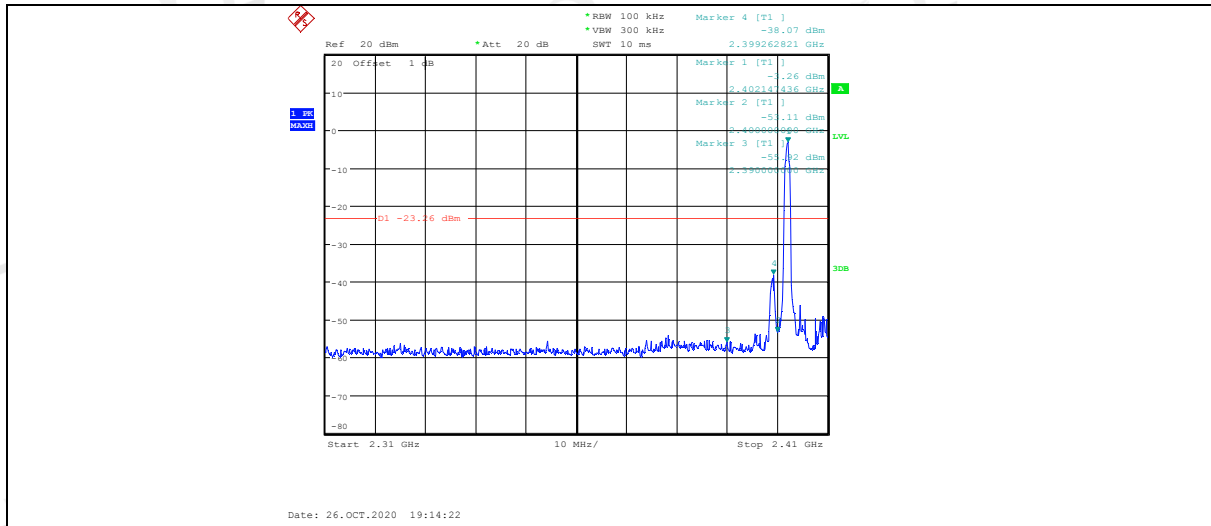

2DH5 ANT1 High

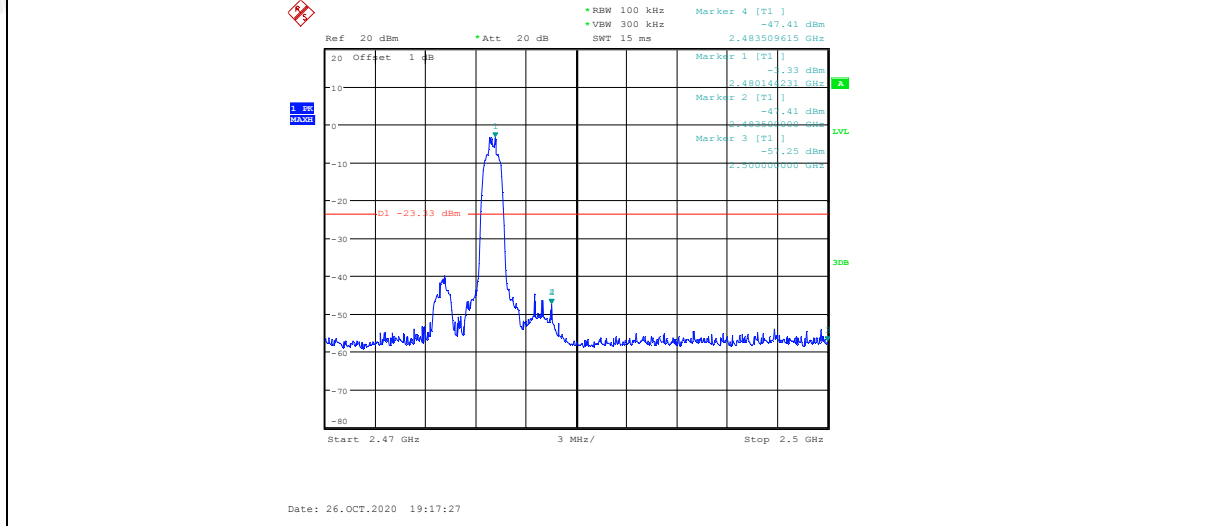

2DH5 ANT1 Low

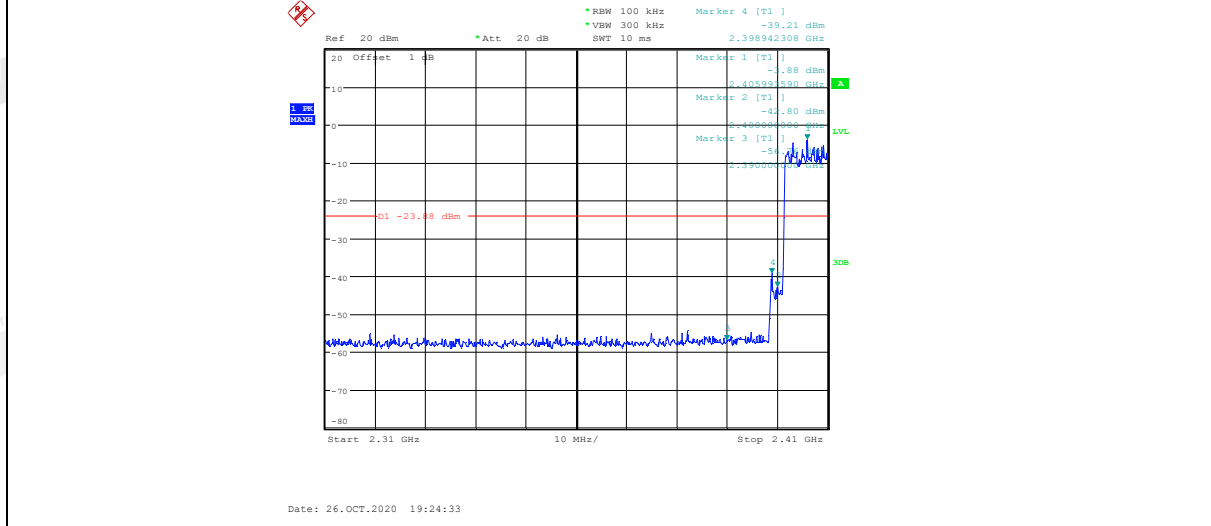

2DH5 ANT1 High

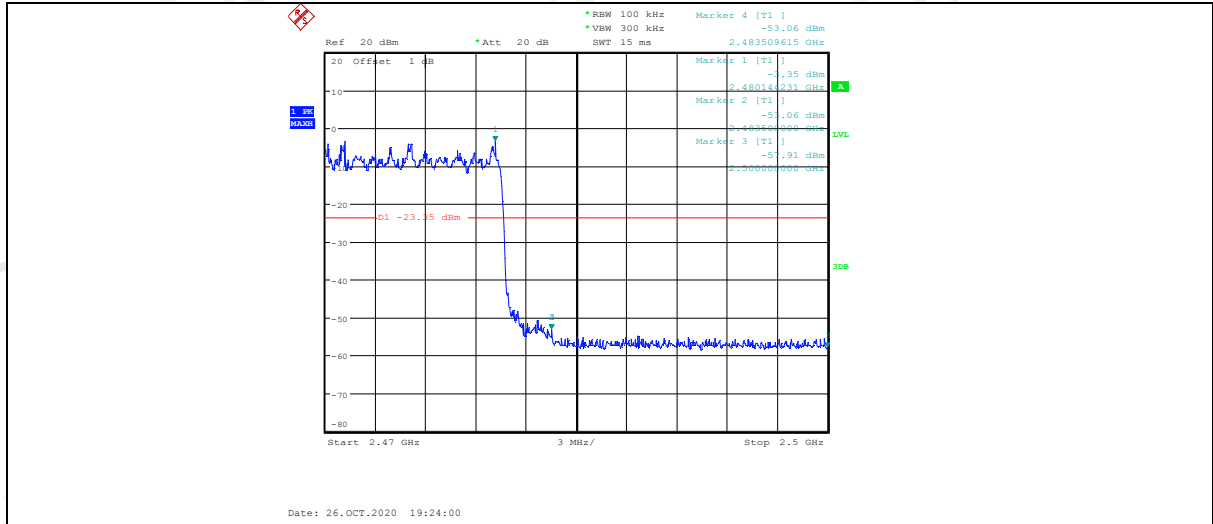

3DH5 ANT1 Low

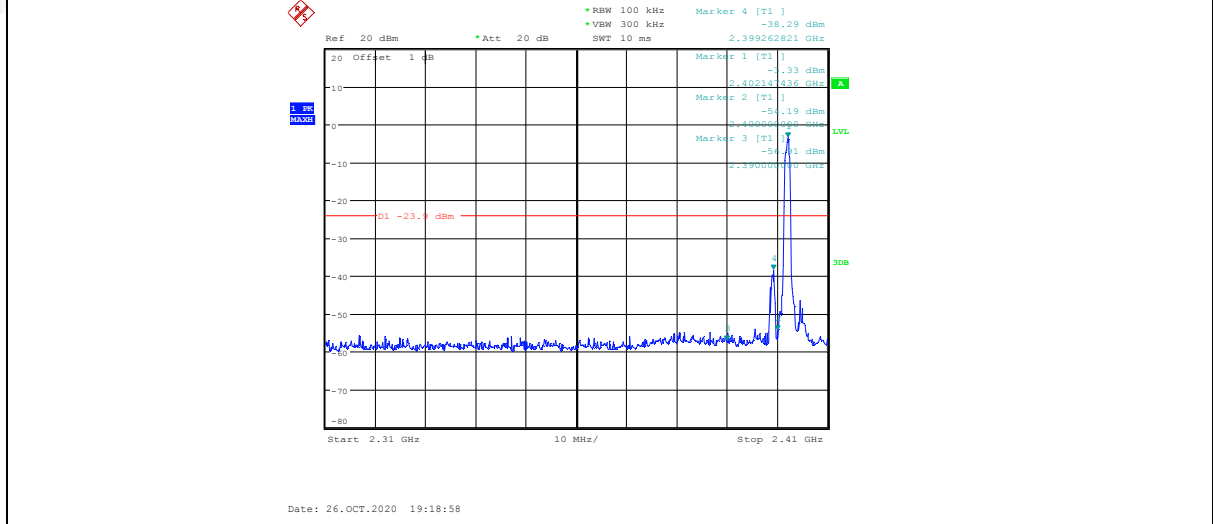

3DH5 ANT1 High

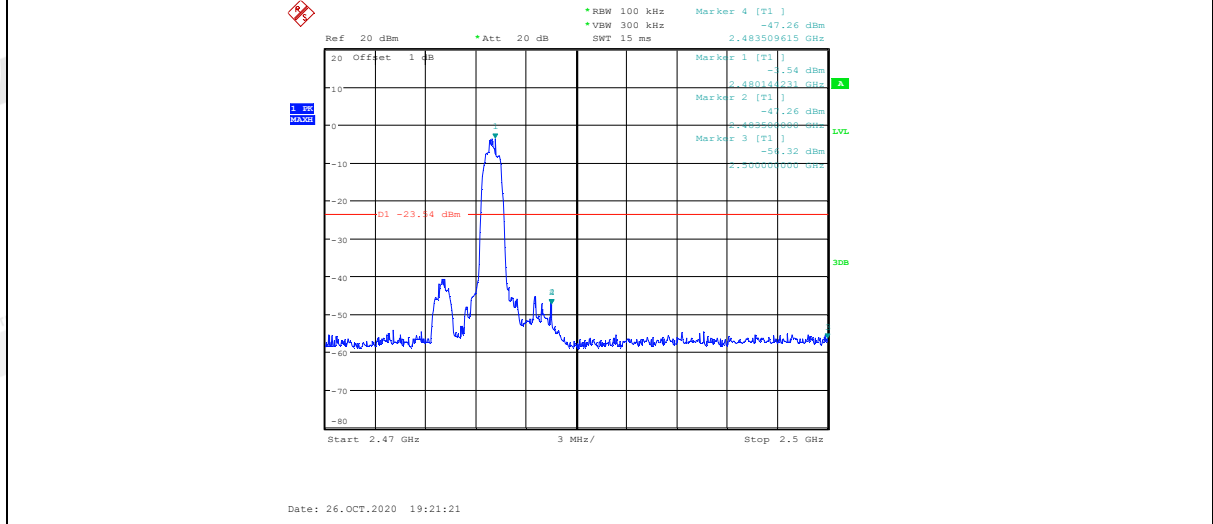

3DH5 ANT1 Low

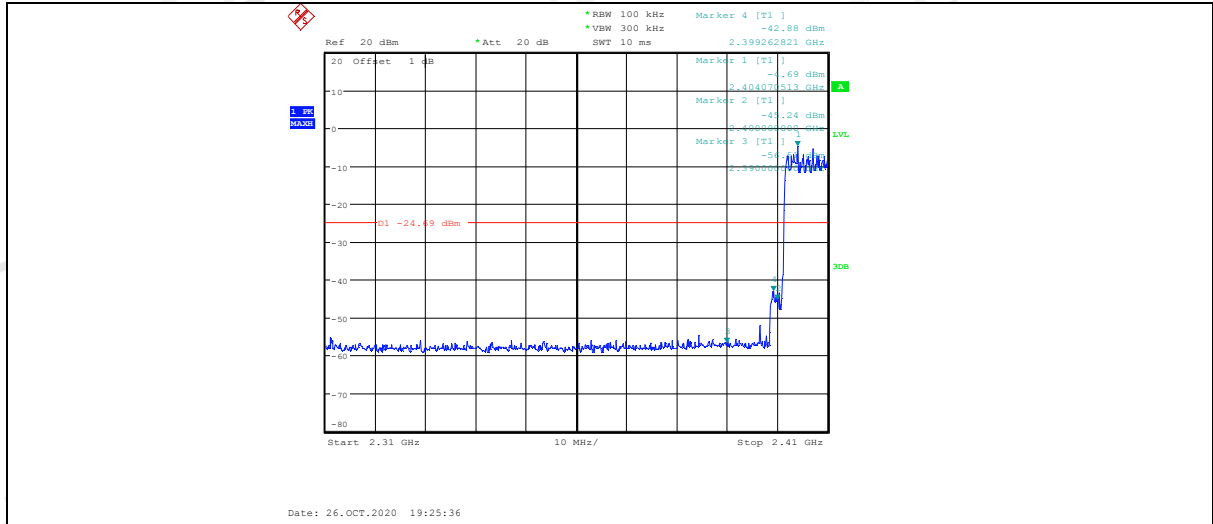

3DH5 ANT1 High

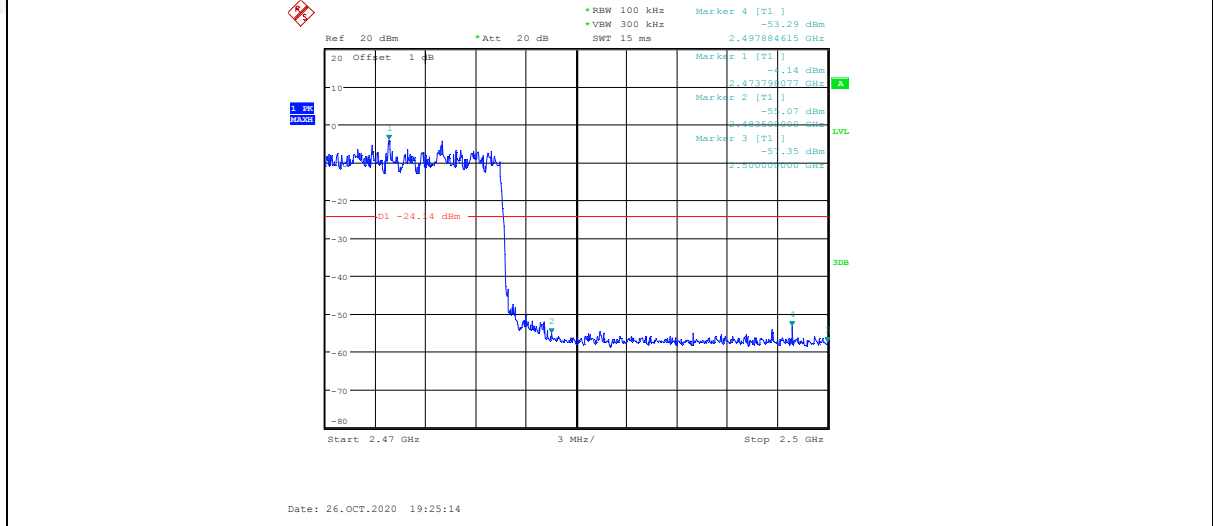

10. Radiated Emission

10.1. Block diagram of test setup

In 3 m Anechoic Chamber, test setup diagram for 9 kHz - 30 MHz

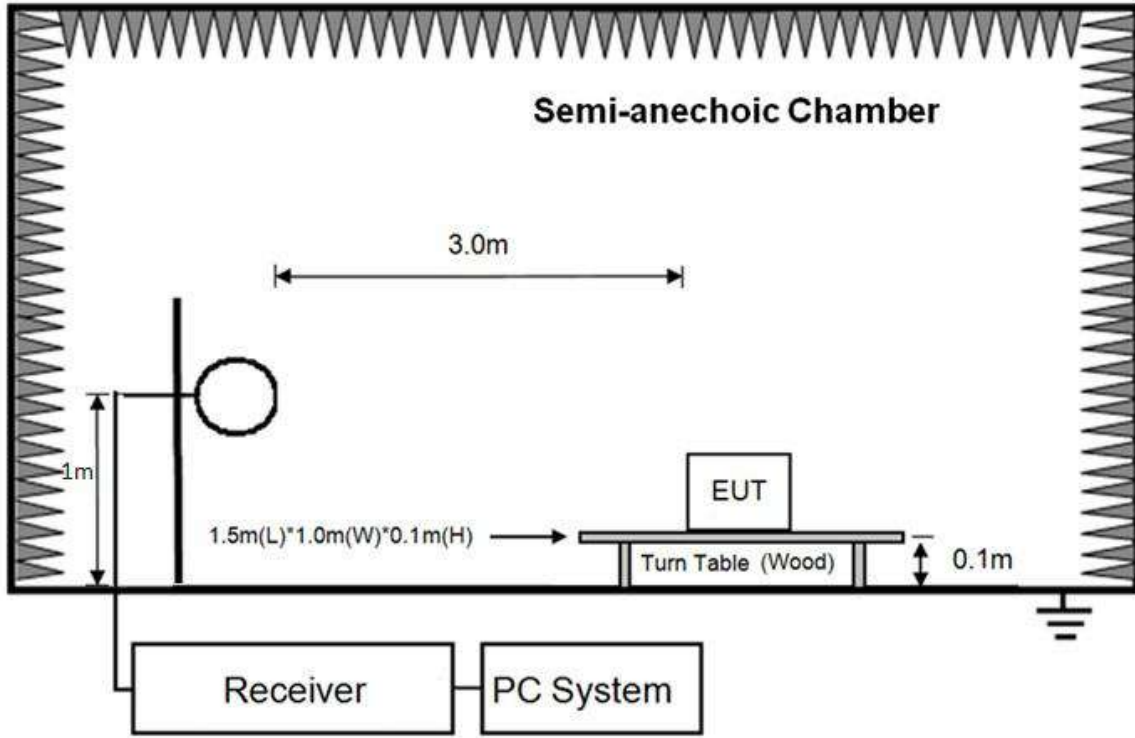

In 3 m Anechoic Chamber, test setup diagram for below 1 GHz

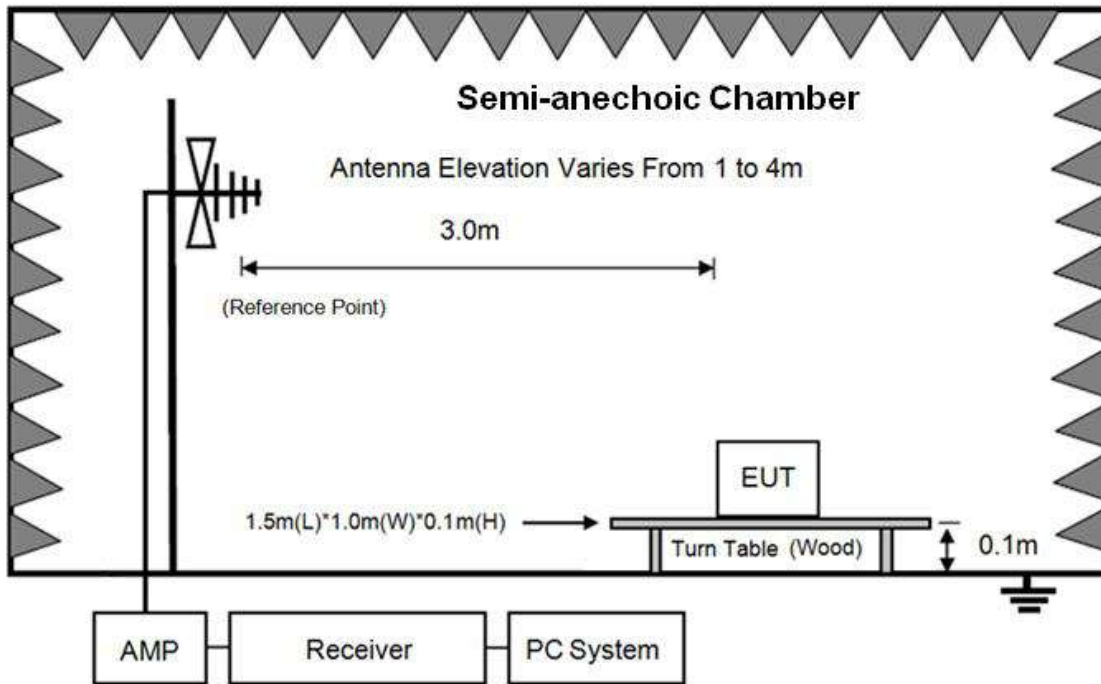

In 3 m Anechoic Chamber, test setup diagram for frequency above 1 GHz

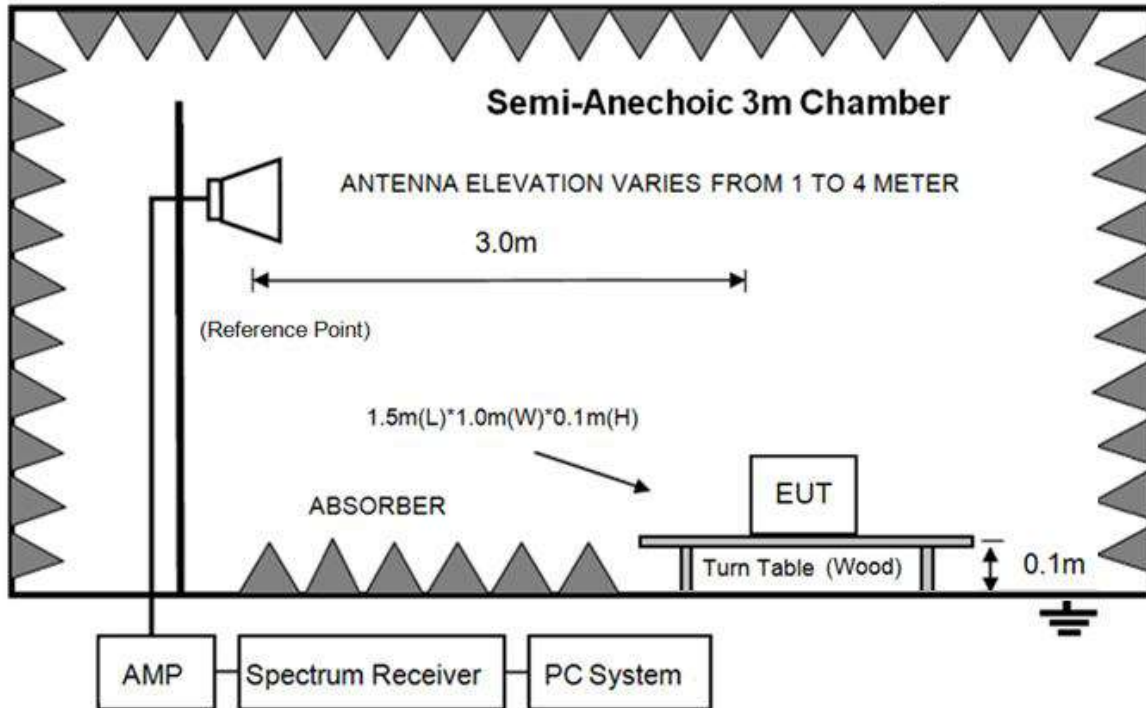

Note: For harmonic emissions test an appropriate high pass filter was inserted in the input port of AMP.

10.2. Limit

(1) FCC 15.205 Restricted frequency band

| MHz | MHz | MHz | GHz |
|--------------------------|---------------------|---------------|------------------|
| 0.090-0.110 | 16.42-16.423 | 399.9-410 | 4.5-5.15 |
| ¹ 0.495-0.505 | 16.69475-16.69525 | 608-614 | 5.35-5.46 |
| 2.1735-2.1905 | 16.80425-16.80475 | 960-1240 | 7.25-7.75 |
| 4.125-4.128 | 25.5-25.67 | 1300-1427 | 8.025-8.5 |
| 4.1772&4.17775 | 37.5-38.25 | 1435-1626.5 | 9.0-9.2 |
| 4.2072&4.20775 | 73-74.6 | 1645.5-1646.5 | 9.3-9.5 |
| 6.215-6.218 | 74.8-75.2 | 1660-1710 | 10.6-12.7 |
| 6.26775-6.26825 | 108-121.94 | 1718.8-1722.2 | 13.25-13.4 |
| 6.31175-6.31225 | 123-138 | 2200-2300 | 14.47-14.5 |
| 8.291-8.294 | 149.9-150.05 | 2310-2390 | 15.35-16.2 |
| 8.362-8.366 | 156.52475-156.52525 | 2483.5-2500 | 17.7-21.4 |
| 8.37625-8.38675 | 156.7-156.9 | 2690-2900 | 22.01-23.12 |
| 8.41425-8.41475 | 162.0125-167.17 | 3260-3267 | 23.6-24.0 |
| 12.29-12.293 | 167.72-173.2 | 3332-3339 | 31.2-31.8 |
| 12.51975-12.52025 | 240-285 | 3345.8-3358 | 36.43-36.5 |
| 12.57675-12.57725 | 322-335.4 | 3600-4400 | (²) |
| 13.36-13.41 | | | |

¹Until February 1, 1999, this restricted band shall be 0.490-0.510 MHz.

²Above 38.6
(2) FCC 15.209 Limit.

| Frequency (MHz) | Measurement distance (meters) | Field strength limit | |
|-----------------|-------------------------------|---|-----------------------------------|
| | | $\mu\text{V}/\text{m}$ | $\text{dB}(\mu\text{V})/\text{m}$ |
| 0.009 ~ 0.490 | 300 | 2400/F(kHz) | 67.6-20log(F) |
| 0.490 ~ 1.705 | 30 | 24000/F(kHz) | 87.6-20log(F) |
| 1.705 ~ 30.0 | 30 | 30 | 29.54 |
| 30 ~ 88 | 3 | 100 | 40.0 |
| 88 ~ 216 | 3 | 150 | 43.5 |
| 216 ~ 960 | 3 | 200 | 46.0 |
| 960 ~ 1000 | 3 | 500 | 54.0 |
| Above 1000 | 3 | 74.0 dB(μV)/m (Peak) 54.0 dB(μV)/m (Average) | |

Note: (1) The emission limits shown in the above table are based on measurements employing a CISPR QP detector except for the frequency bands 9 - 90 kHz, 110 - 490 kHz and above 1000 MHz, radiated emissions limits in these three bands are based on measurements employing an average detector.

(2) At frequencies below 30 MHz, measurement may be performed at a distance closer than that specified, and the limit at closer measurement distance can be extrapolated by below formula:

$$\text{Limit}_{3\text{m}}(\text{dB}\mu\text{V}/\text{m}) = \text{Limit}_{30\text{m}}(\text{dB}\mu\text{V}/\text{m}) + 40\text{Log}(30\text{m}/3\text{m})$$

(3) Limit for this EUT

All the emissions appearing within 15.205 restricted frequency bands shall not exceed the limits shown in 15.209, all the other emissions shall be at least 20 dB below the fundamental emissions or comply with 15.209 limits.

10.3. Test procedure

- (1) EUT was placed on a non-metallic table, 80 cm above the ground plane inside a semi-anechoic chamber for below 1 GHz and 150 cm above the ground plane inside a fully-anechoic chamber for above 1 GHz.
- (2) Test antenna was located 3 m from the EUT on an adjustable mast, and the antenna used as below table.

| Test frequency range | Test antenna used | Test antenna distance |
|----------------------|--|-----------------------|
| 9 kHz - 30 MHz | Active Loop antenna | 3 m |
| 30 MHz - 1 GHz | Trilog Broadband Antenna | 3 m |
| 1 GHz - 18 GHz | Double Ridged Horn Antenna (1 GHz - 18 GHz) | 3 m |
| 18 GHz - 40 GHz | Horn Antenna (18 GHz - 40 GHz) | 1 m |

According ANSI C63.10:2013 clause 6.4.4.2 and 6.5.3, for measurements below 30 MHz, the

loop antenna was positioned with its plane vertical from the EUT and rotated about its vertical axis for maximum response at each azimuth position around the EUT. And the loop antenna also is positioned with its plane horizontal at the specified distance from the EUT. The center of the loop is 1 m above the ground. For measurement above 30 MHz, the trilob Broadband Antenna or Horn Antenna was located 3 m from EUT, Measurements were made with the antenna positioned in both the horizontal and vertical planes of Polarization, and the measurement antenna was varied from 1 m to 4 m. in height above the reference ground plane to obtain the maximum signal strength.

(3) Below pre-scan procedure was first performed in order to find prominent frequency spectrum radiated emissions from 9 kHz to 25 GHz:

(a) Scanning the peak frequency spectrum with the antenna specified in step (3), and the EUT was rotated 360 degree, the antenna height was varied from 1 m to 4 m (Except loop antenna, it's fixed 1 m above ground.)

(b) Change work frequency or channel of device if practicable.

(c) Change modulation type of device if practicable.

(d) Change power supply range from 85% to 115% of the rated supply voltage

(e) Rotated EUT though three orthogonal axes to determine the attitude of EUT arrangement produces highest emissions.

Spectrum frequency from 9 kHz to 25 GHz (tenth harmonic of fundamental frequency) was investigated, and no any obvious emission were detected from 18 GHz to 25 GHz, so below final test was performed with frequency range from 9 kHz to 18 GHz.

(4) For final emissions measurements at each frequency of interest, the EUT was rotated and the antenna height was varied between 1 m and 4 m in order to maximize the emission. Measurements in both horizontal and vertical polarities were made and the data was recorded. In order to find the maximum emission, the relative positions of equipment and all of the interface cables were changed according to ANSI C63.10:2013 on Radiated Emission test.

(5) The emissions from 9 kHz to 1 GHz were measured based on CISPR QP detector except for the frequency bands 9 - 90 kHz, 110 - 490 kHz, for emissions from 9 kHz - 90 kHz, 110 kHz - 490 kHz and above 1 GHz were measured based on average detector, for emissions above 1 GHz, peak emissions also be measured and need comply with Peak limit.

(6) The emissions from 9 kHz to 1 GHz, QP or average values were measured with EMI receiver with below RBW.

| Frequency band | RBW |
|------------------|---------|
| 9 kHz - 150 kHz | 200 Hz |
| 150 kHz - 30 MHz | 9 kHz |
| 30 MHz - 1 GHz | 120 kHz |

(7) For emissions above 1 GHz, both Peak and Average level were measured with Spectrum Analyzer, and the RBW is set at 1 MHz, VBW is set at 3 MHz for Peak measure; according ANSI C63.10:2013 clause 4.1.4.2.2 procedure for average measure.

10.4. Test result

Pass. (See below detailed test result)

All the emissions except fundamental emission from 9 kHz to 25 GHz were comply with 15.209 limits.

Note1: According exploratory test, the emission levels are 20 dB below the limit detected from 9 kHz to 30 MHz and 18 GHz to 25 GHz, so the final test was performed with frequency range from 30 MHz to 18 GHz and recorded in below.

Note2: For emissions below 1 GHz, according exploratory explorer test, when change Tx mode and channel, have no distinct influence on emissions level, so for emissions below 1 GHz, the final test was only performed with EUT working in 8DPSK, Tx 2402 MHz mode.

Note3: For emissions above 1 GHz. If peak results comply with AV limit, AV Result is deemed to comply with AV limit.

Radiated Emission test (below 1 GHz) TR-4-E-009 Radiated Emission Test Result

Test Site : DDT 3m Chamber 2#
Test Date : 2020-11-23
EUT : HIGH-POWER BLUETOOTH-ENABLED SPEAKER SYSTEM WITH LIGHTS
Power Supply : AC 120V/60Hz
Condition : Temp:26.1°C,Humi:59%,Press:101.4kPa
Memo :

D:\2020 RE2# Report Data\Q20101602-1E IPA122A\1123 RE.EM6
Tested By : Chunchieh Huang
Model Number : Total PA Glow Max
Test Mode : Tx mode
Antenna/Distance : 2019 VULB 9163 2#/3m/HORIZONTAL

Data: 19

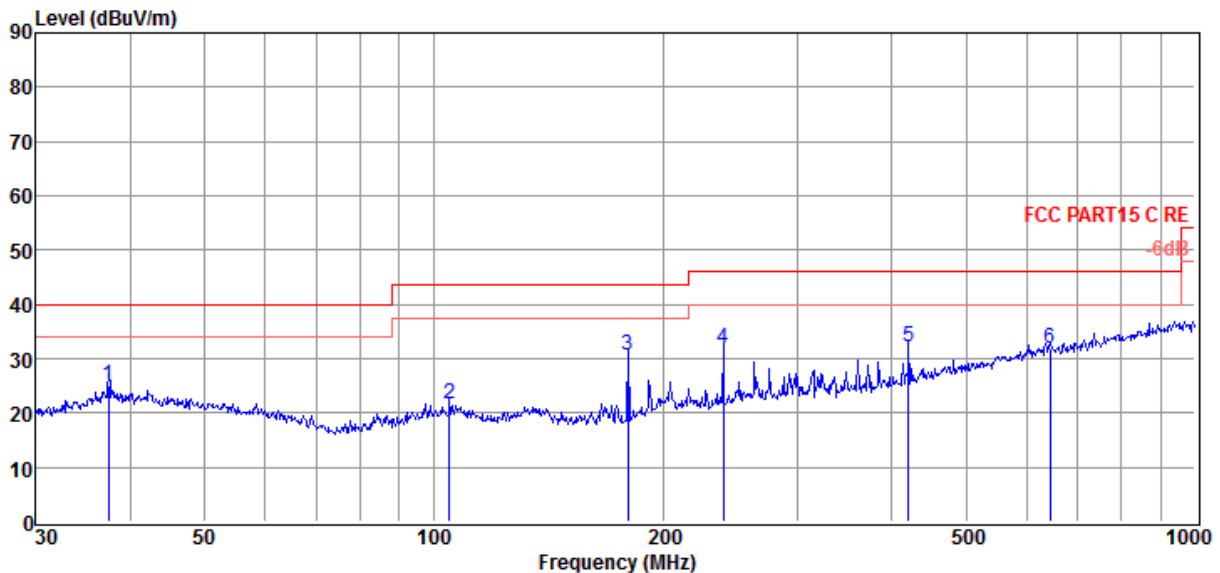

| Item (Mark) | Freq. (MHz) | Read Level (dBμV) | Antenna Factor (dB/m) | Cable Loss (dB) | Result Level (dBμV/m) | Limit Line (dBμV/m) | Over Limit (dB) | Detector | Polarization |
|-------------|-------------|-------------------|-----------------------|-----------------|-----------------------|---------------------|-----------------|----------|--------------|
| 1 | 37.42 | 7.43 | 13.97 | 3.68 | 25.08 | 40.00 | -14.92 | QP | HORIZONTAL |
| 2 | 104.90 | 5.66 | 11.65 | 4.24 | 21.55 | 43.50 | -21.95 | QP | HORIZONTAL |
| 3 | 180.02 | 16.14 | 9.80 | 4.73 | 30.67 | 43.50 | -12.83 | QP | HORIZONTAL |
| 4 | 239.99 | 14.27 | 12.57 | 5.08 | 31.92 | 46.00 | -14.08 | QP | HORIZONTAL |
| 5 | 420.58 | 10.23 | 15.99 | 5.93 | 32.15 | 46.00 | -13.85 | QP | HORIZONTAL |
| 6 | 645.12 | 5.34 | 19.58 | 6.96 | 31.88 | 46.00 | -14.12 | QP | HORIZONTAL |

Note: 1. Result Level = Read Level + Antenna Factor + Cable loss.
 2. If Peak Result complies with QP limit, QP Result is deemed to comply with QP limit.
 3. Test setup: RBW: 120 kHz, VBW: 300 kHz, Sweep time: auto.

TR-4-E-009 Radiated Emission Test Result

Test Site : DDT 3m Chamber 2#

D:\2020 RE2# Report Data\Q20101602-1E IPA122A\1123 RE.EM6

Test Date : 2020-11-23

Tested By : Chunchieh Huang

EUT : HIGH-POWER BLUETOOTH-ENABLED
SPEAKER SYSTEM WITH LIGHTS

Model Number : Total PA Glow Max

Power Supply : AC 120V/60Hz

Test Mode : Tx mode

Condition : Temp:26.1°C,Humi:59%,Press:101.4kPa

Antenna/Distance : 2019 VULB 9163 2#/3m/VERTICAL
e

Memo :

Data: 20

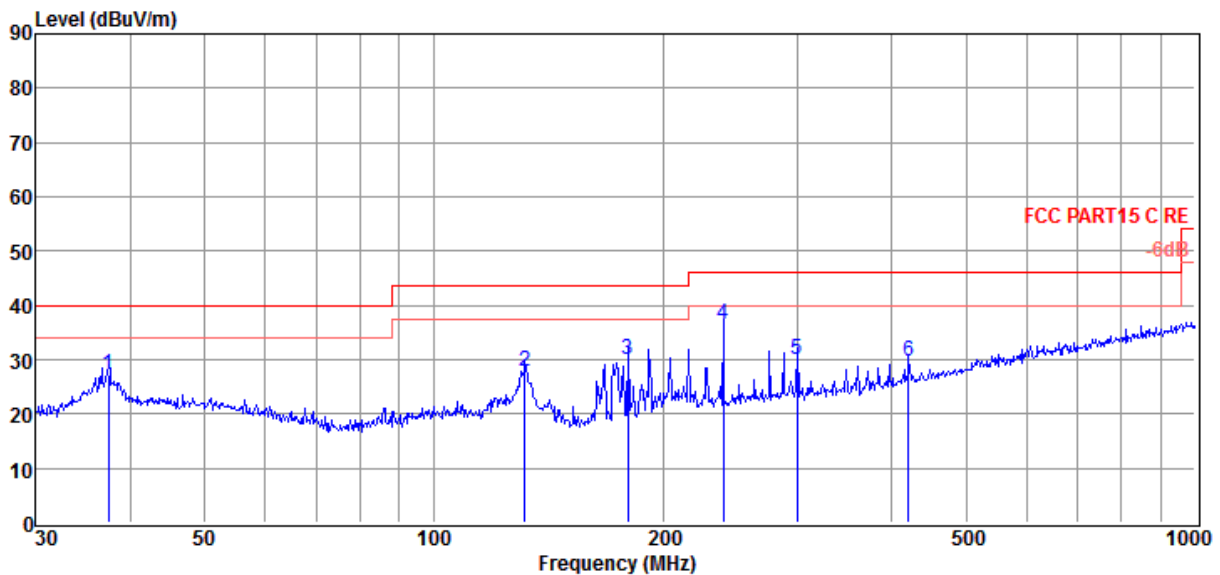

| Item (Mark) | Freq. (MHz) | Read Level (dBuV) | Antenna Factor (dB/m) | Cable Loss (dB) | Result Level (dBuV/m) | Limit Line (dBuV/m) | Over Limit (dB) | Detector | Polarization |
|-------------|-------------|-------------------|-----------------------|-----------------|-----------------------|---------------------|-----------------|----------|--------------|
| 1 | 37.42 | 9.51 | 13.97 | 3.68 | 27.16 | 40.00 | -12.84 | QP | VERTICAL |
| 2 | 131.76 | 14.69 | 8.71 | 4.44 | 27.84 | 43.50 | -15.66 | QP | VERTICAL |
| 3 | 180.02 | 15.57 | 9.80 | 4.73 | 30.10 | 43.50 | -13.40 | QP | VERTICAL |
| 4 | 239.99 | 18.93 | 12.57 | 5.08 | 36.58 | 46.00 | -9.42 | QP | VERTICAL |
| 5 | 300.37 | 10.72 | 14.01 | 5.37 | 30.10 | 46.00 | -15.90 | QP | VERTICAL |
| 6 | 420.58 | 7.81 | 15.99 | 5.93 | 29.73 | 46.00 | -16.27 | QP | VERTICAL |

Note: 1. Result Level = Read Level + Antenna Factor + Cable loss.

2. If Peak Result complies with QP limit, QP Result is deemed to comply with QP limit.

3. Test setup: RBW: 120 kHz, VBW: 300 kHz, Sweep time: auto.

Radiated Emission test (above 1 GHz)

| Freq. (MHz) | Read level (dB μ V) | Antenna Factor (dB/m) | PRM Factor (dB) | Cable Loss (dB) | Result Level (dB μ V/m) | Limit (dB μ V/m) | Margin (dB) | Detector type | Polarization |
|-------------------------|-------------------------|-----------------------|-----------------|-----------------|-----------------------------|----------------------|-------------|---------------|--------------|
| Tx mode 2402 MHz | | | | | | | | | |
| 4808.00 | 44.97 | 32.23 | 43.48 | 6.16 | 39.88 | 74.00 | -34.12 | Peak | HORIZONTAL |
| 7205.00 | 43.88 | 37.12 | 42.91 | 7.79 | 45.88 | 74.00 | -28.12 | Peak | HORIZONTAL |
| 9602.00 | 42.41 | 39.18 | 42.47 | 9.07 | 48.19 | 74.00 | -25.81 | Peak | HORIZONTAL |
| 12016.00 | 42.73 | 39.08 | 42.28 | 10.55 | 50.08 | 74.00 | -23.92 | Peak | HORIZONTAL |
| 13920.00 | 42.10 | 40.80 | 40.37 | 10.91 | 53.44 | 74.00 | -20.56 | Peak | HORIZONTAL |
| 13920.00 | 37.44 | 40.80 | 40.37 | 10.91 | 48.78 | 54.00 | -5.22 | Average | HORIZONTAL |
| 4808.00 | 46.51 | 32.23 | 43.48 | 6.16 | 41.42 | 74.00 | -32.58 | Peak | VERTICAL |
| 7205.00 | 44.97 | 37.12 | 42.91 | 7.79 | 46.97 | 74.00 | -27.03 | Peak | VERTICAL |
| 9602.00 | 43.71 | 39.18 | 42.47 | 9.07 | 49.49 | 74.00 | -24.51 | Peak | VERTICAL |
| 12016.00 | 45.43 | 39.08 | 42.28 | 10.55 | 52.78 | 74.00 | -21.22 | Peak | VERTICAL |
| 14685.00 | 42.63 | 40.50 | 40.23 | 11.42 | 54.32 | 74.00 | -19.68 | Peak | VERTICAL |
| 14685.00 | 38.25 | 40.50 | 40.23 | 11.42 | 49.94 | 54.00 | -4.06 | Average | VERTICAL |
| Tx mode 2441 MHz | | | | | | | | | |
| 4884.00 | 55.05 | 32.34 | 43.46 | 6.20 | 50.13 | 74.00 | -23.87 | Peak | HORIZONTAL |
| 7324.00 | 45.29 | 37.19 | 42.89 | 7.93 | 47.52 | 74.00 | -26.48 | Peak | HORIZONTAL |
| 9772.00 | 43.68 | 39.32 | 42.44 | 9.20 | 49.76 | 74.00 | -24.24 | Peak | HORIZONTAL |
| 12203.00 | 43.59 | 38.90 | 42.08 | 10.58 | 50.99 | 74.00 | -23.01 | Peak | HORIZONTAL |
| 13886.00 | 42.97 | 40.76 | 40.41 | 10.90 | 54.22 | 74.00 | -19.78 | Peak | HORIZONTAL |
| 13886.00 | 38.25 | 40.76 | 40.41 | 10.90 | 49.50 | 54.00 | -4.50 | Average | HORIZONTAL |
| 4876.00 | 48.23 | 32.33 | 43.46 | 6.20 | 43.30 | 74.00 | -30.70 | Peak | VERTICAL |
| 7324.00 | 43.08 | 37.19 | 42.89 | 7.93 | 45.31 | 74.00 | -28.69 | Peak | VERTICAL |
| 9772.00 | 43.25 | 39.32 | 42.44 | 9.20 | 49.33 | 74.00 | -24.67 | Peak | VERTICAL |
| 12203.00 | 43.49 | 38.90 | 42.08 | 10.58 | 50.89 | 74.00 | -23.11 | Peak | VERTICAL |
| 14141.00 | 43.04 | 40.87 | 40.28 | 11.03 | 54.66 | 74.00 | -19.34 | Peak | VERTICAL |
| 14141.00 | 37.65 | 40.87 | 40.28 | 11.03 | 49.27 | 54.00 | -4.73 | Average | VERTICAL |
| Tx mode 2480 MHz | | | | | | | | | |
| 4960.00 | 53.64 | 32.44 | 43.43 | 6.25 | 48.90 | 74.00 | -25.10 | Peak | HORIZONTAL |
| 7443.00 | 45.63 | 37.27 | 42.88 | 8.06 | 48.08 | 74.00 | -25.92 | Peak | HORIZONTAL |
| 9925.00 | 44.45 | 39.44 | 42.41 | 9.32 | 50.80 | 74.00 | -23.20 | Peak | HORIZONTAL |
| 12407.00 | 43.62 | 38.69 | 41.87 | 10.61 | 51.05 | 74.00 | -22.95 | Peak | HORIZONTAL |
| 13920.00 | 43.52 | 40.80 | 40.37 | 10.91 | 54.86 | 74.00 | -19.14 | Peak | HORIZONTAL |
| 13920.00 | 37.68 | 40.80 | 40.37 | 10.91 | 49.02 | 54.00 | -4.98 | Average | HORIZONTAL |
| 4960.00 | 52.74 | 32.44 | 43.43 | 6.25 | 48.00 | 74.00 | -26.00 | Peak | VERTICAL |
| 7443.00 | 44.81 | 37.27 | 42.88 | 8.06 | 47.26 | 74.00 | -26.74 | Peak | VERTICAL |
| 9925.00 | 44.07 | 39.44 | 42.41 | 9.32 | 50.42 | 74.00 | -23.58 | Peak | VERTICAL |
| 12407.00 | 43.57 | 38.69 | 41.87 | 10.61 | 51.00 | 74.00 | -23.00 | Peak | VERTICAL |
| 14685.00 | 43.70 | 40.50 | 40.23 | 11.42 | 55.39 | 74.00 | -18.61 | Peak | VERTICAL |
| 14685.00 | 36.89 | 40.50 | 40.23 | 11.42 | 48.58 | 54.00 | -5.42 | Average | VERTICAL |
| Result: Pass | | | | | | | | | |

Note: 1. 30 MHz ~ 25 GHz: (Scan with GFSK, $\pi/4$ -DQPSK and 8DPSK mode, the worst case is 8DPSK Mode)

2. Result Level = Read Level + Antenna Factor + Cable loss - PRM Factor.

3. For emissions above 1 GHz. If peak results comply with AV limit, AV Result is deemed to comply with AV limit.

11. RF Conducted Spurious Emissions

11.1. Block diagram of test setup

Same as section 4.1

11.2. Limits

In any 100 kHz bandwidth outside the frequency bands in which the spread spectrum intentional radiator is operating, the radio frequency power that is produced by the intentional radiator shall be at least 20 dB below that in the 100 kHz bandwidth within the band that contains the highest level of the desired power.

11.3. Test procedure

(1) Connect EUT's antenna output to spectrum analyzer by RF cable.

(2) Establish a reference level by using the following procedure:

| | |
|------------------|---|
| Center frequency | Test frequency |
| RBW: | 100 kHz |
| VBW: | 300 kHz |
| Span | Wide enough to capture the peak level of the in-band emission |
| Detector Mode: | Peak |
| Sweep time: | auto |
| Trace mode | Max hold |

(3) Allow the trace to stabilize, use the peak marker function to determine the maximum peak power level to establish the reference level.

(4) Set the spectrum analyzer as follows:

| | |
|------------------------------|--|
| RBW: | 100 kHz |
| VBW: | 300 kHz |
| Span | Encompass frequency range to be measured |
| Number of measurement points | $\geq \text{span/RBW}$ |
| Detector Mode: | Peak |
| Sweep time: | auto |
| Trace mode | Max hold |

(5) Allow the trace to stabilize, use the peak marker function to determine the maximum amplitude of all unwanted emissions outside of the authorized frequency band

11.4. Test result

| Mode | Antenna | Freq. (MHz) | Verdict |
|----------------|---------|------------------|---------|
| GFSK | ANT1 | Hopping off 2402 | Pass |
| | ANT1 | Hopping off 2441 | Pass |
| | ANT1 | Hopping off 2480 | Pass |
| $\pi/4$ -DQPSK | ANT1 | Hopping off 2402 | Pass |
| | ANT1 | Hopping off 2441 | Pass |
| | ANT1 | Hopping off 2480 | Pass |
| 8DPSK | ANT1 | Hopping off 2402 | Pass |
| | ANT1 | Hopping off 2441 | Pass |
| | ANT1 | Hopping off 2480 | Pass |

11.5. Original test data

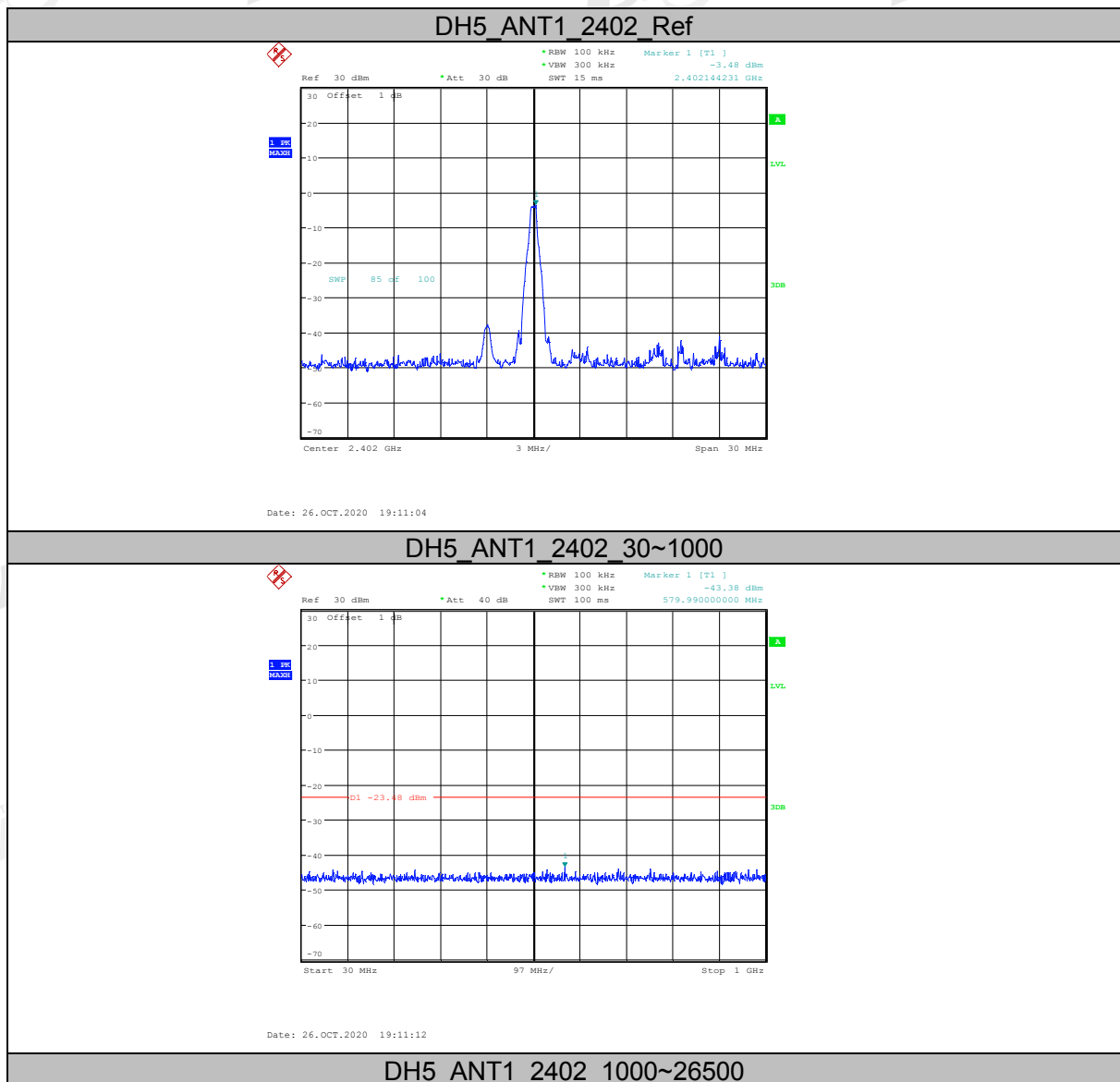

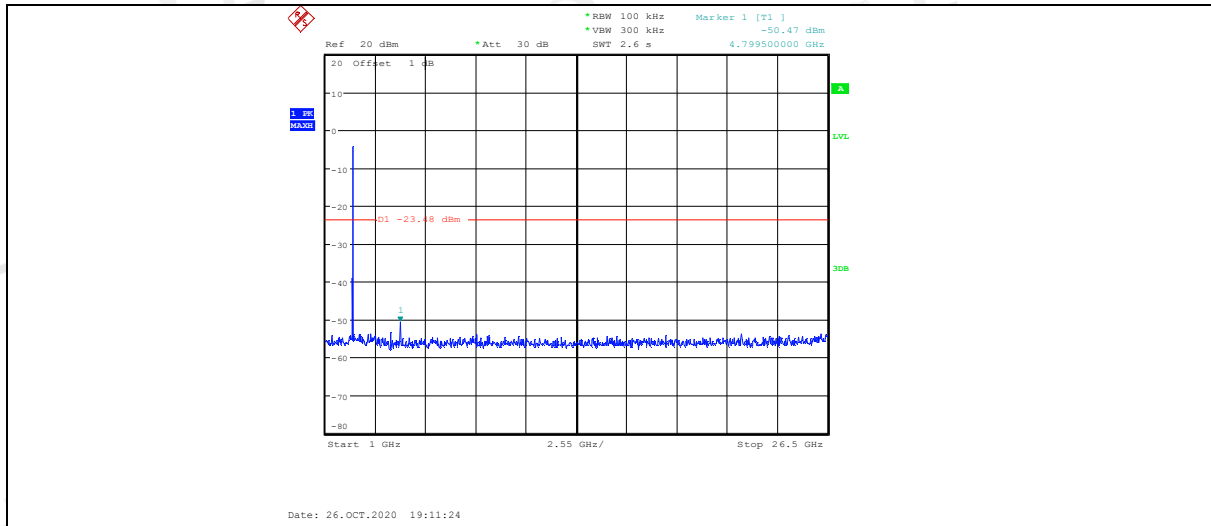

DH5_ANT1_2441_Ref

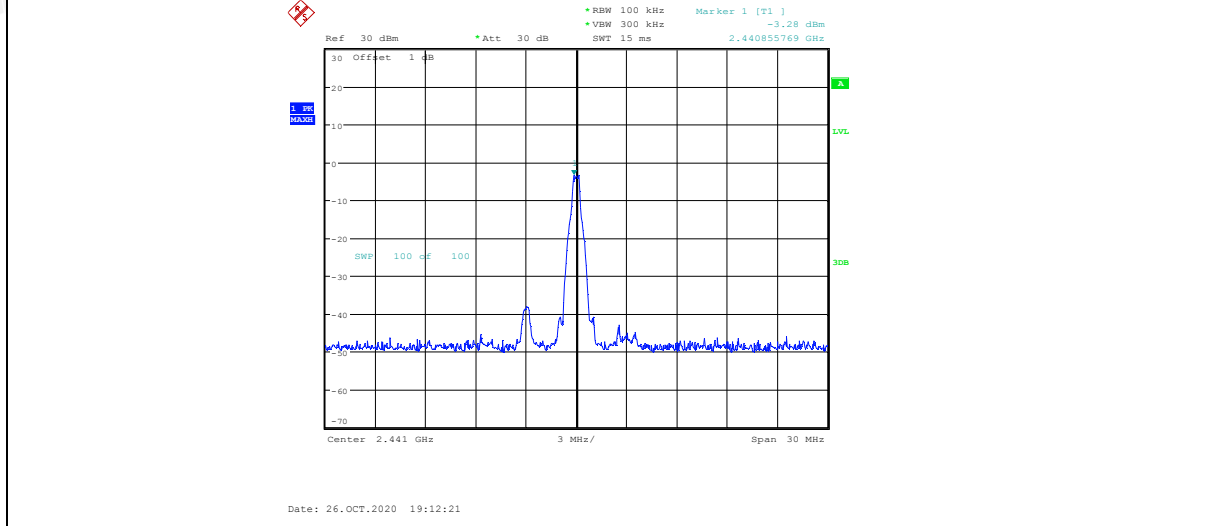

DH5_ANT1_2441_30~1000

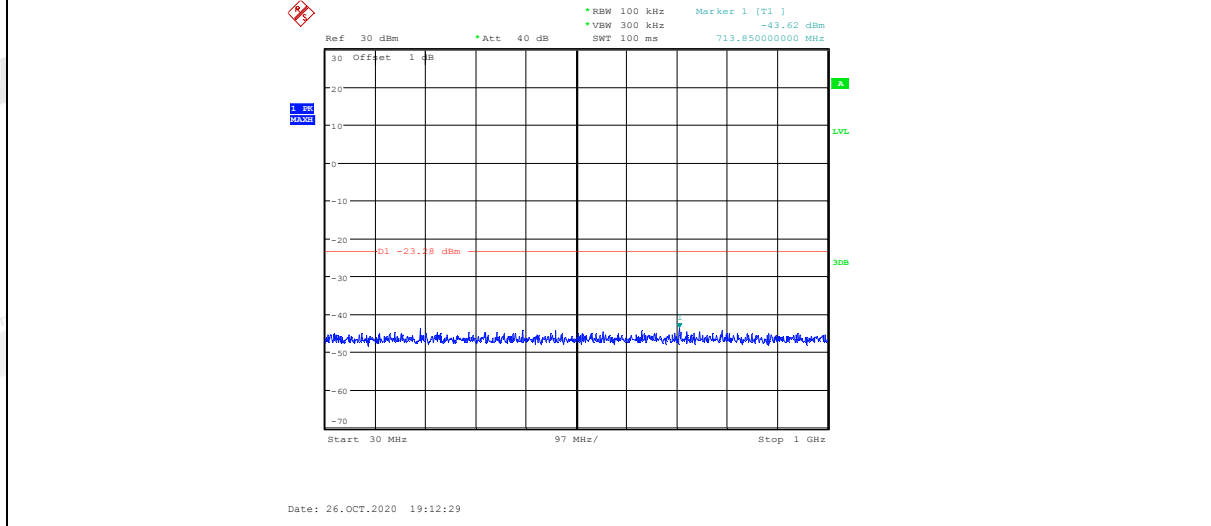

DH5_ANT1_2441_1000~26500

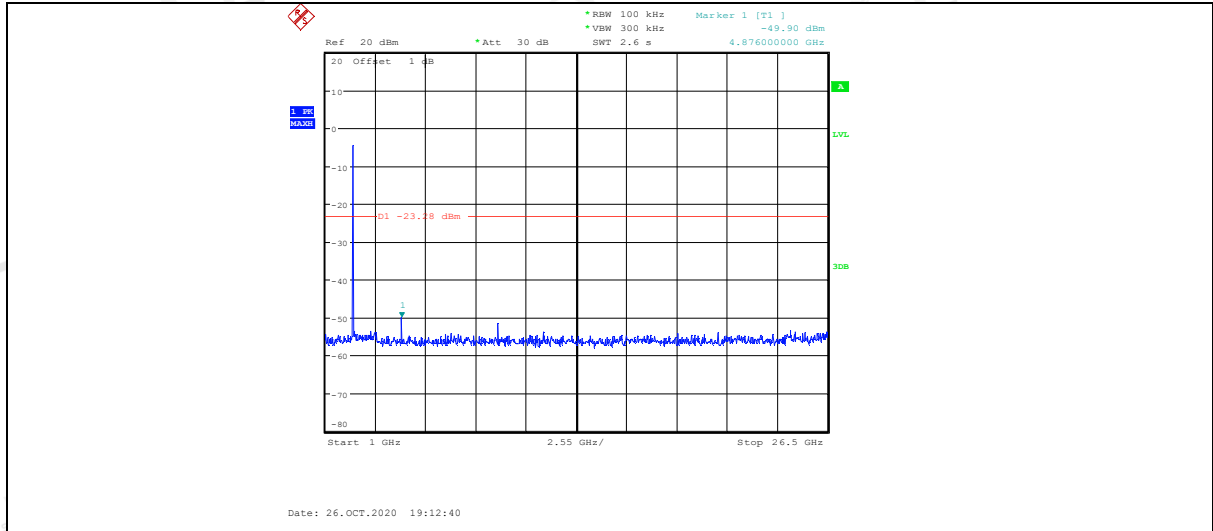

DH5 ANT1 2480 Ref

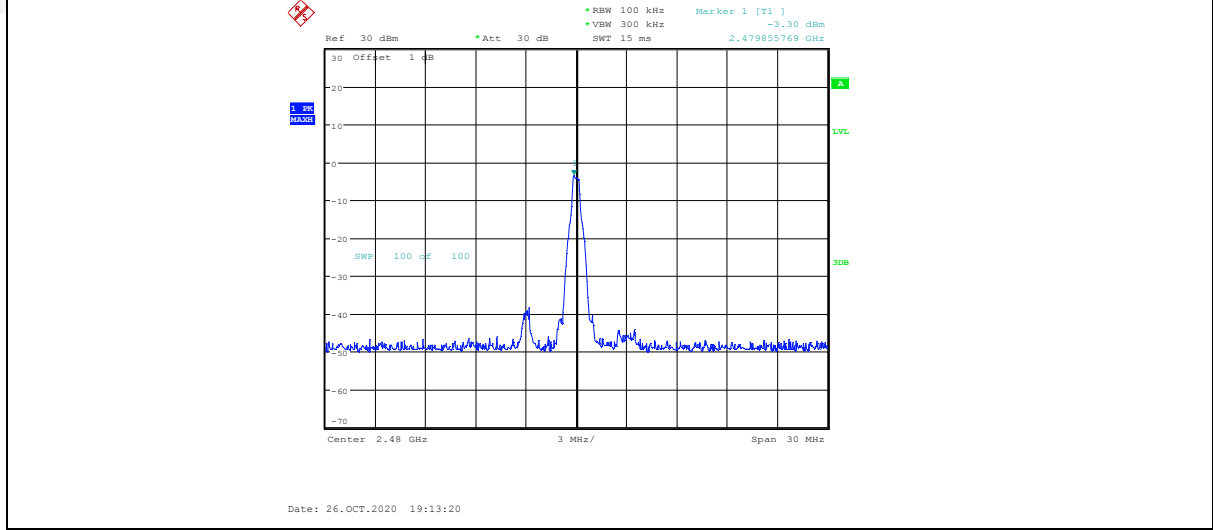

DH5 ANT1 2480 30~1000

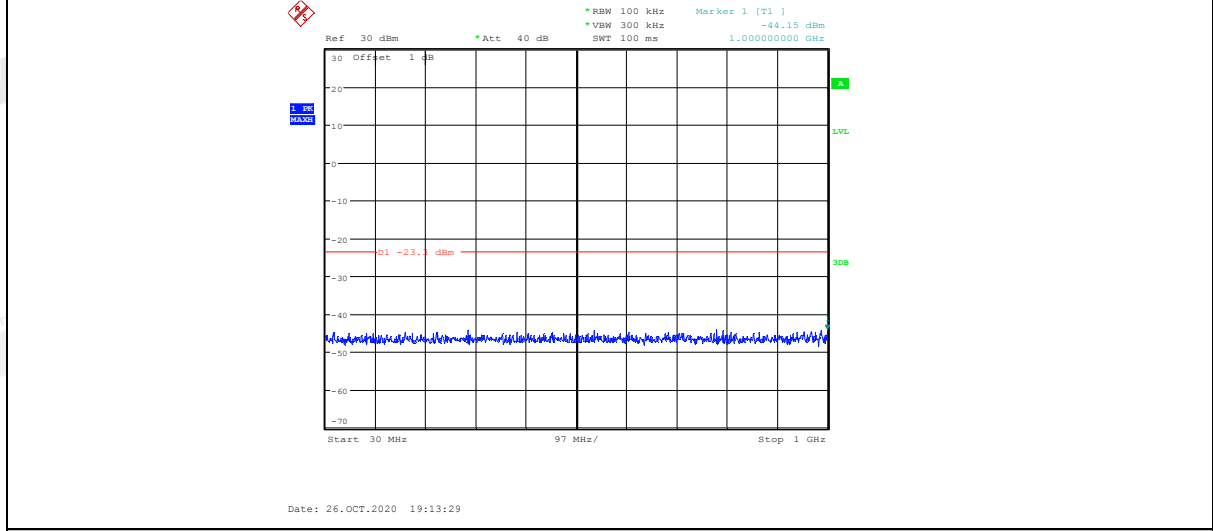

DH5 ANT1 2480 1000~26500

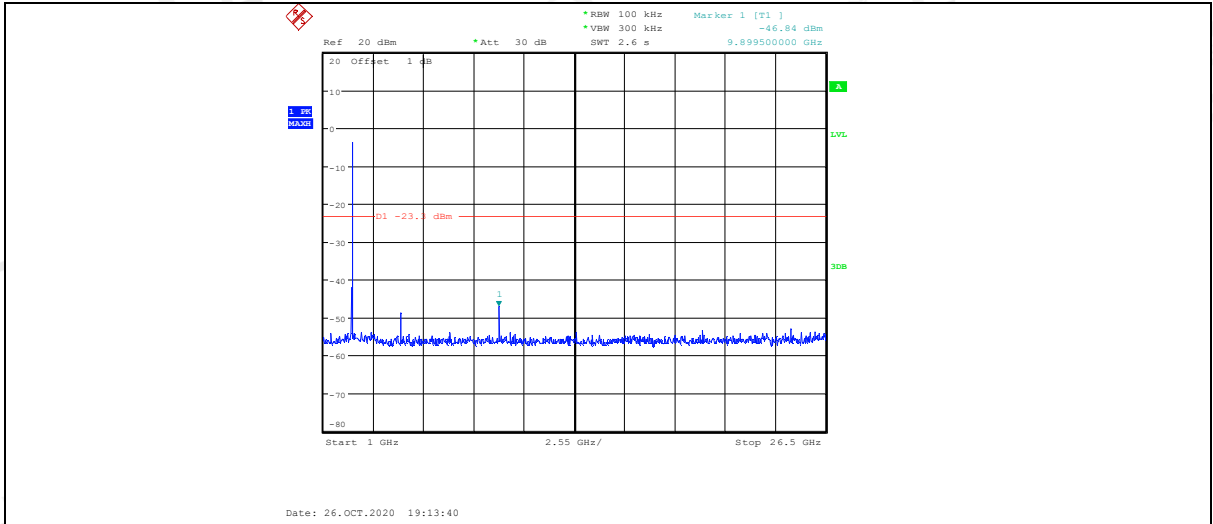

2DH5 ANT1 2402 Ref

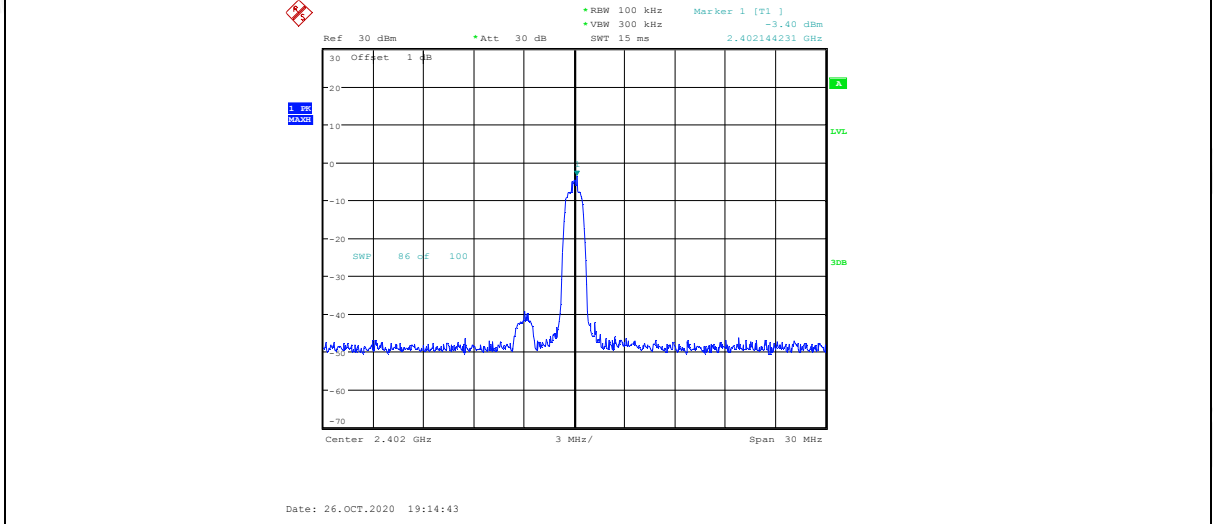

2DH5 ANT1 2402 30~1000

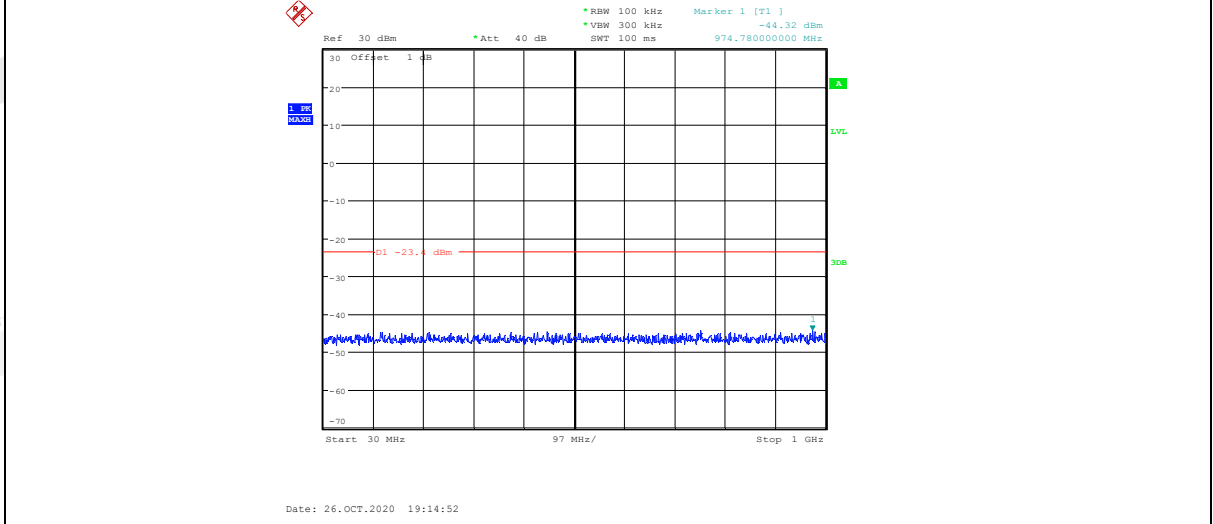

2DH5 ANT1 2402 1000~26500

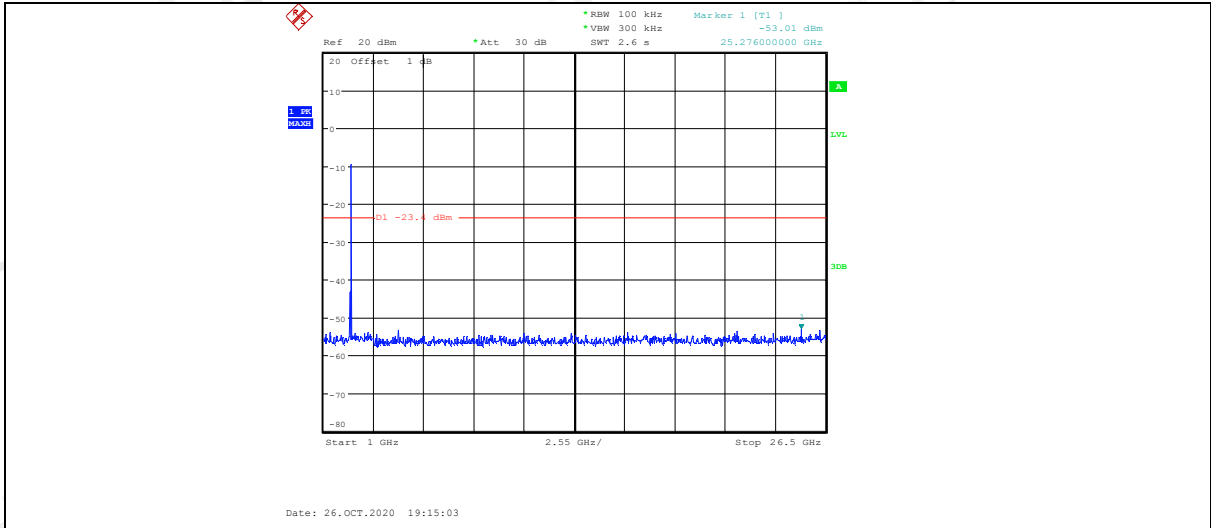

2DH5 ANT1 2441 Ref

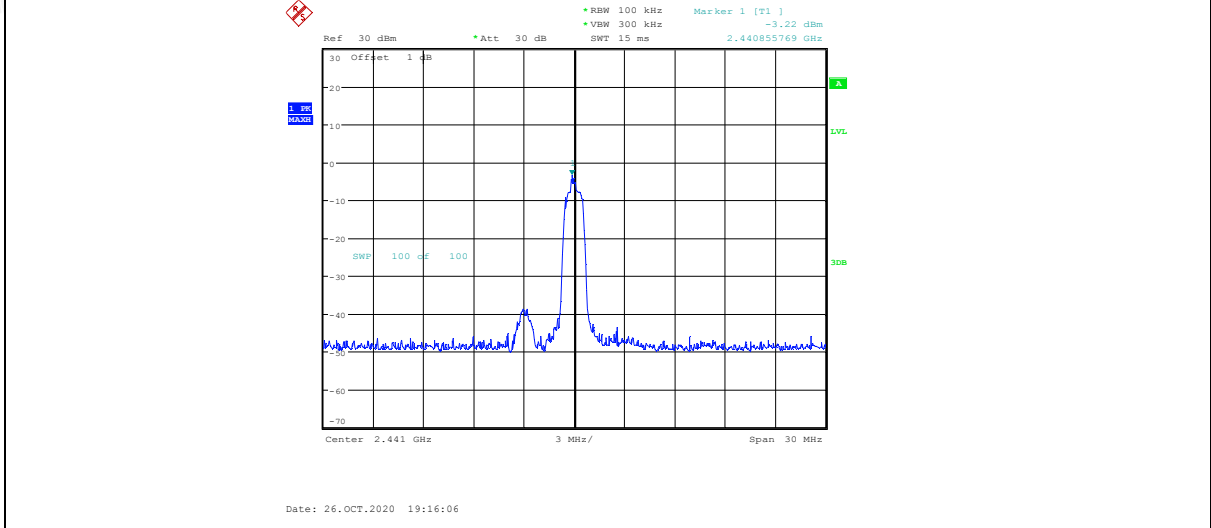

2DH5 ANT1 2441 30~1000

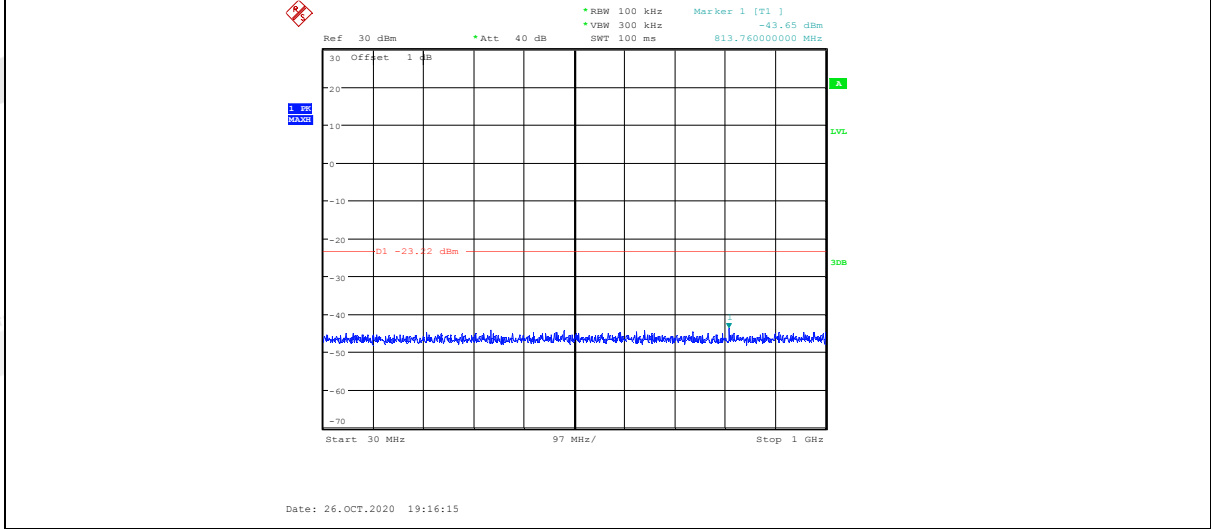

2DH5 ANT1 2441 1000~26500

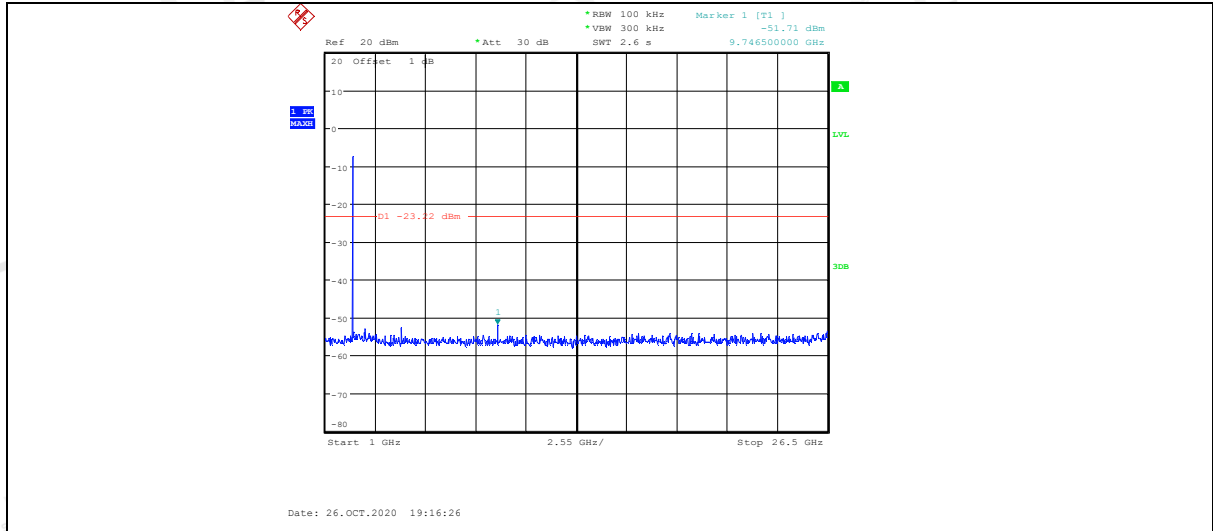

2DH5 ANT1 2480 Ref

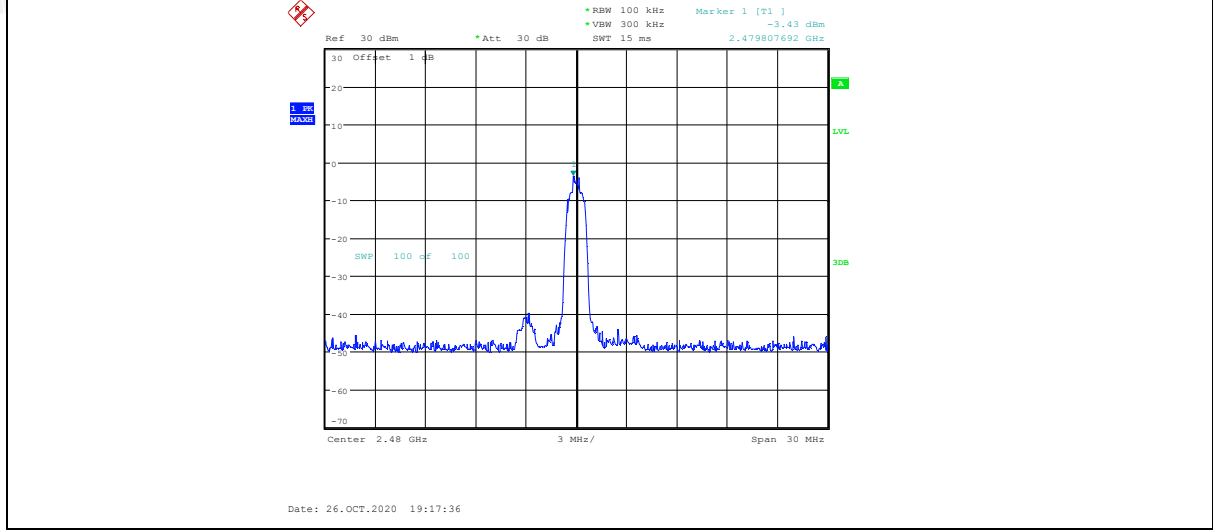

2DH5 ANT1 2480 30~1000

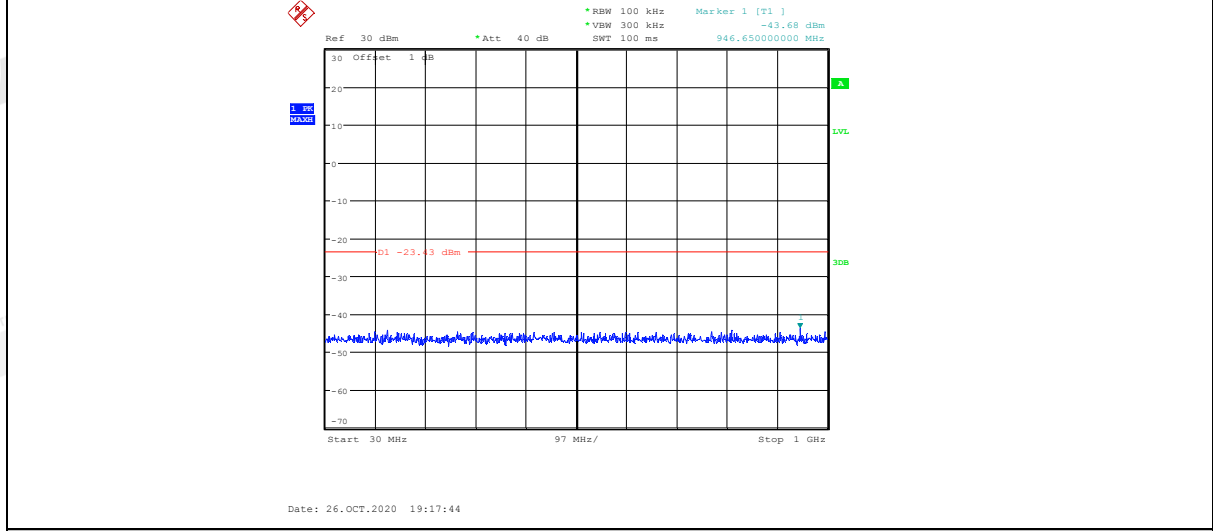

2DH5 ANT1 2480 1000~26500

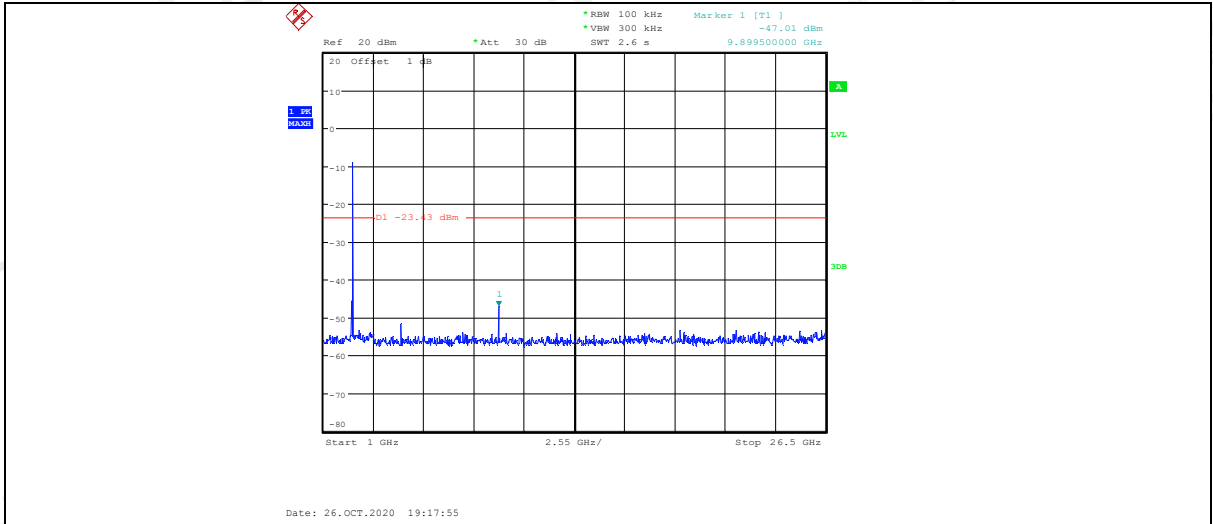

3DH5 ANT1 2402 Ref

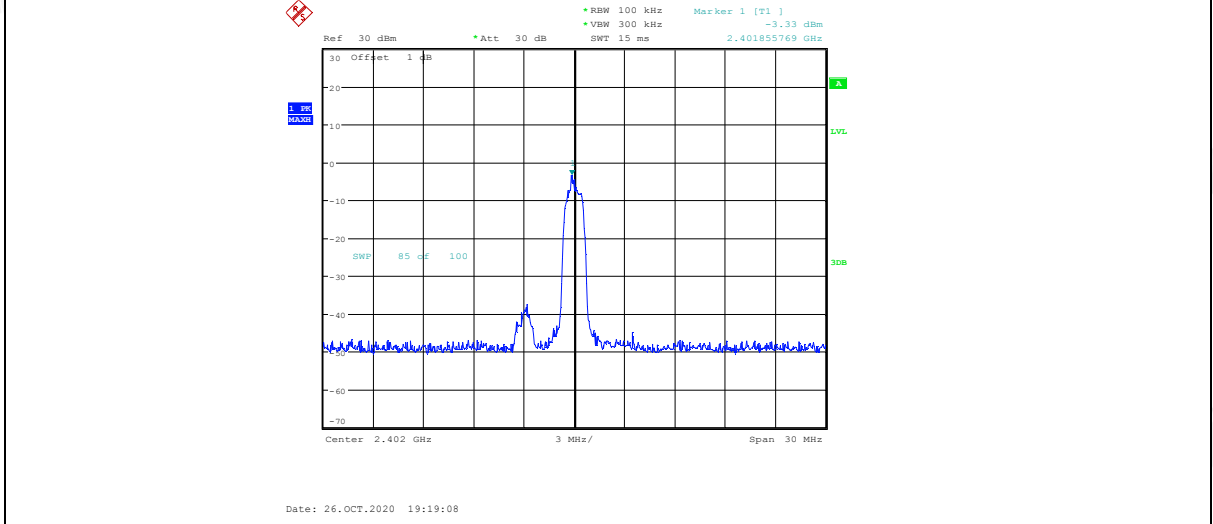

3DH5 ANT1 2402 30~1000

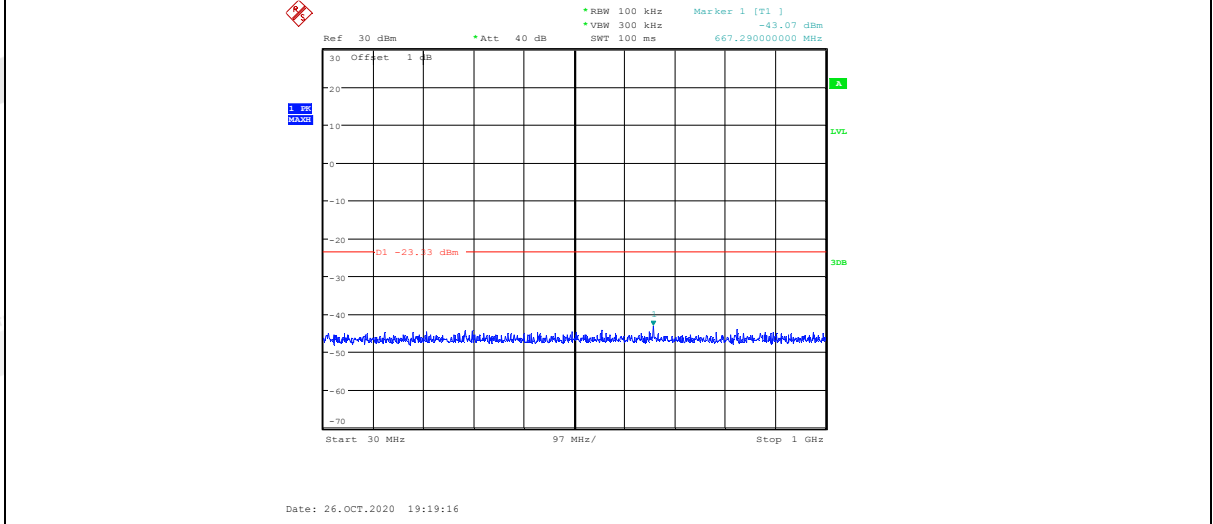

3DH5 ANT1 2402 1000~26500

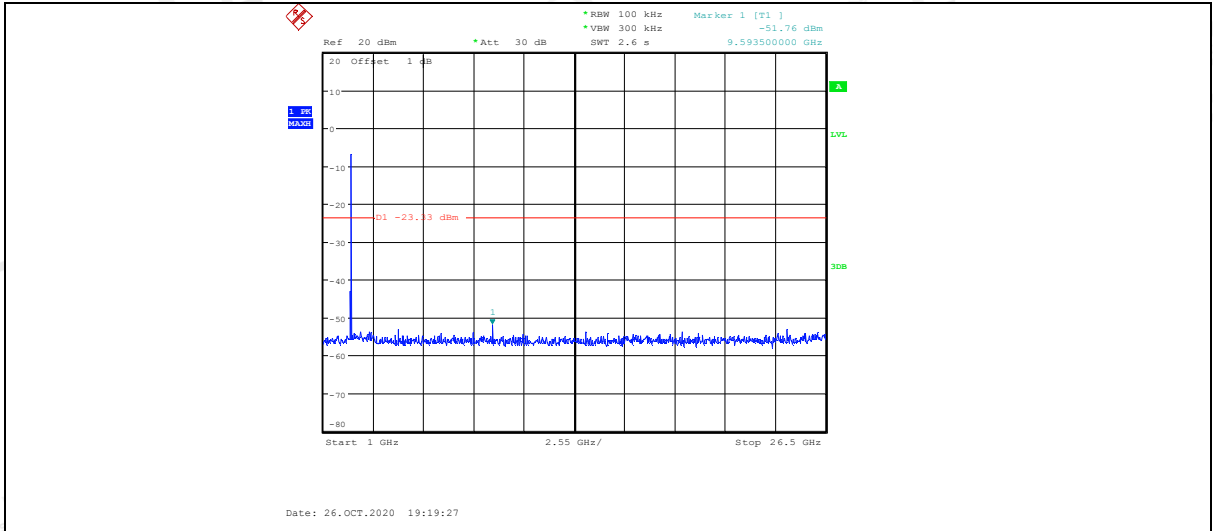

3DH5 ANT1 2441 Ref

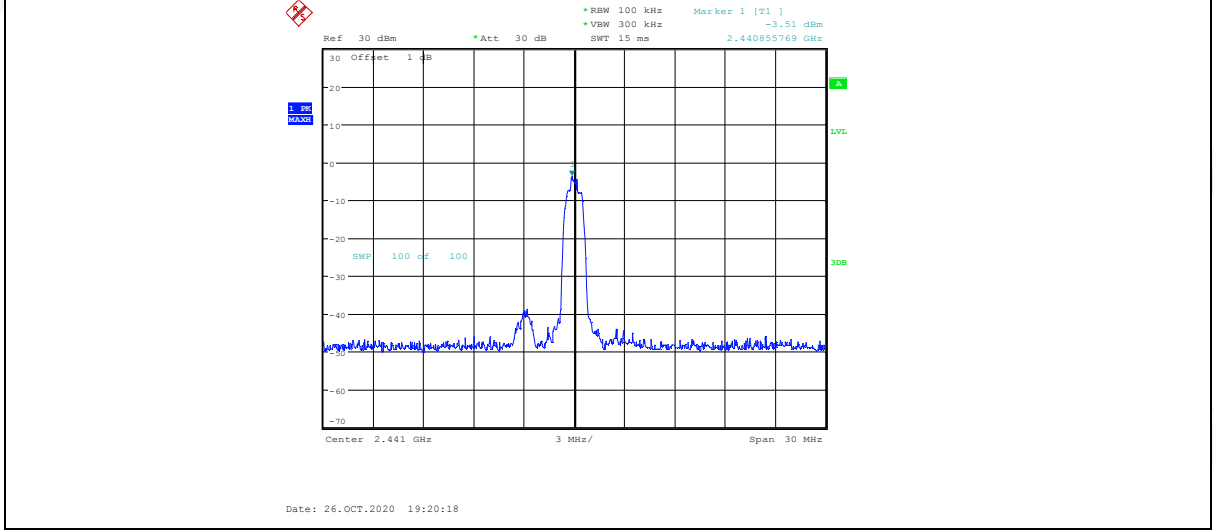

3DH5 ANT1 2441 30~1000

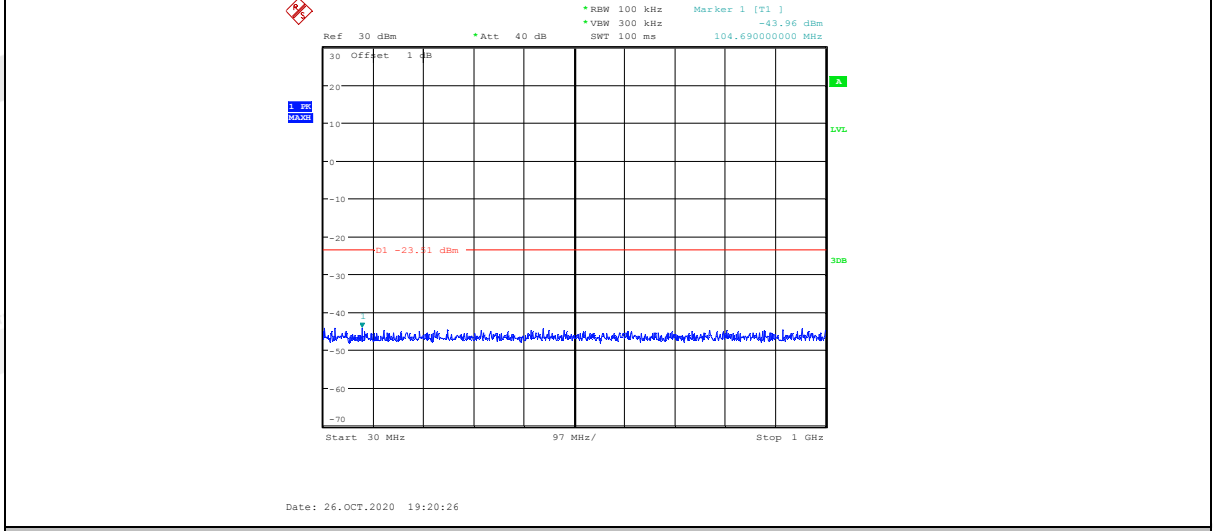

3DH5 ANT1 2441 1000~26500

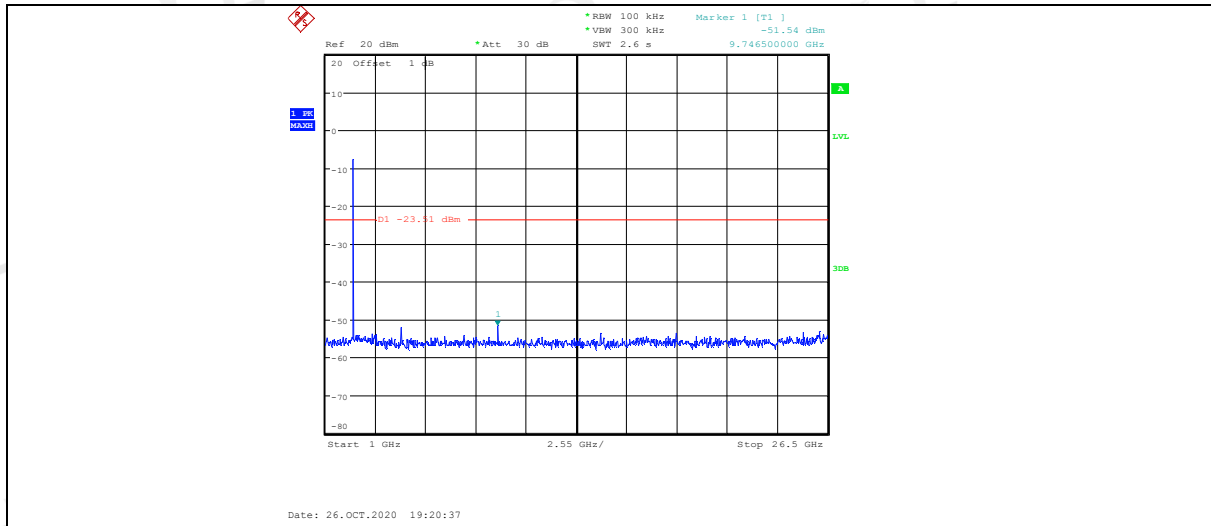

3DH5 ANT1 2480 Ref

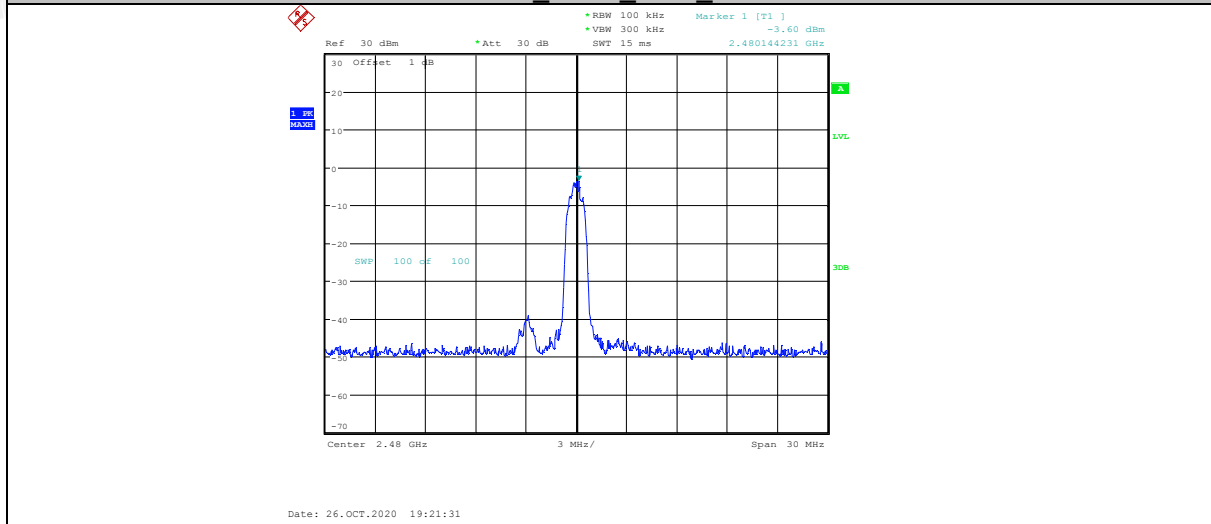

3DH5 ANT1 2480 30~1000

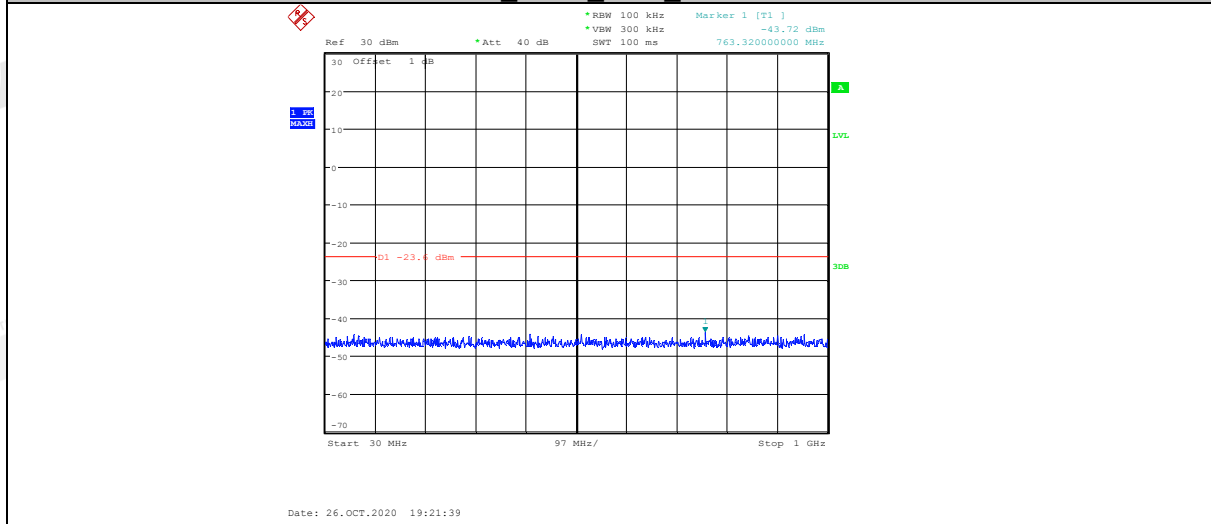

3DH5 ANT1 2480 1000~26500

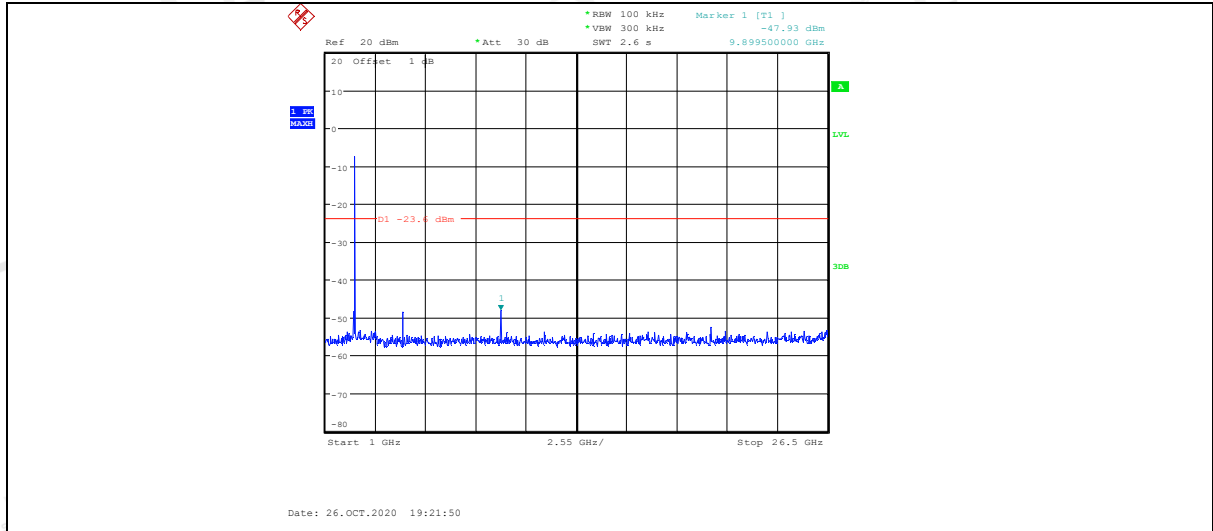

12. Band Edge Compliance (Radiated Method)

12.1. Block diagram of test setup

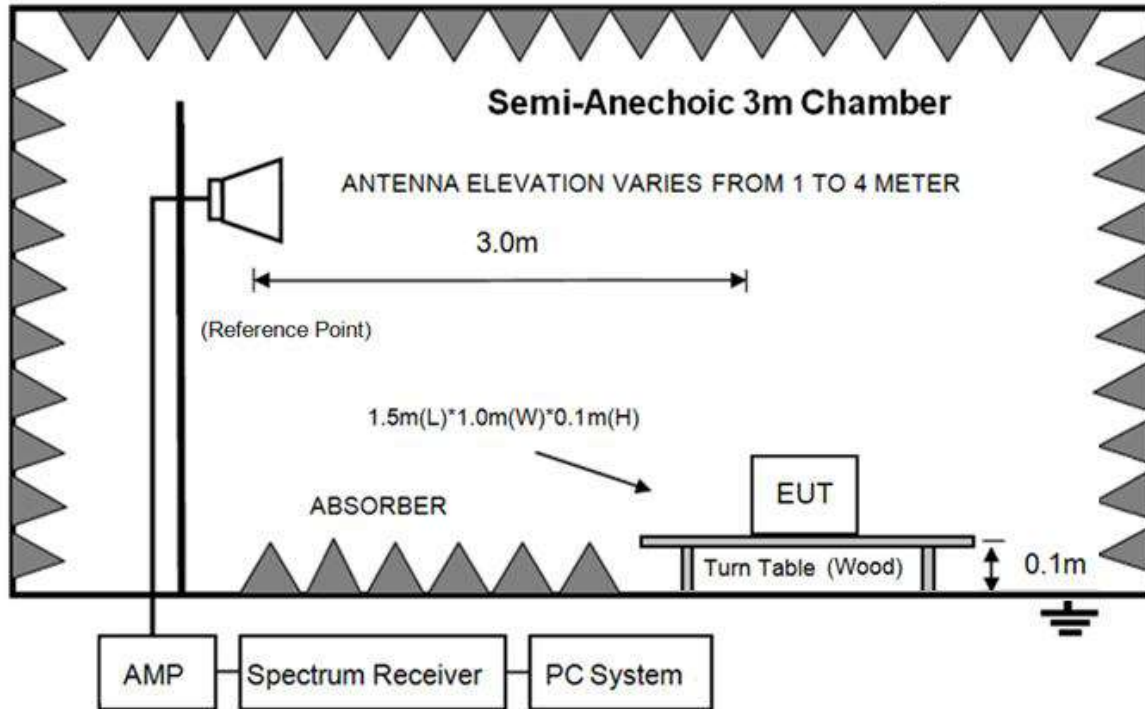

12.2. Limit

All restriction band should comply with 15.209, other emission should be at least 20 dB below the fundamental.

12.3. Test procedure

Same with clause 10.3 except change investigated frequency range from 2310 MHz to 2410 MHz and 2470 MHz to 2500 MHz.

Remark: All restriction band have been tested, and only the worst case is shown in report.

12.4. Test result

Pass. (See below detailed test result)

TR-4-E-009 Radiated Emission Test Result

Test Site : DDT 3m Chamber 2#

D:\2020 RE2# Report Data\Q20092420-1E IPA145\FCC ABOVE1G.EM6

Test Date : 2020-10-23

Tested By : Jacky

EUT : HIGH-POWER BLUETOOTH-ENABLED SPEAKER SYSTEM WITH LIGHTS

Model Number : Total PA Glow Max

Power Supply : AC 120V/60Hz

Test Mode : Tx mode

Condition : Temp:24.5°C,Humi:55%,Press:100.1kPa

Antenna/Distance : 2019 BBHA9120D/3m/VERTICAL

Memo : DH5 2402

Data: 9

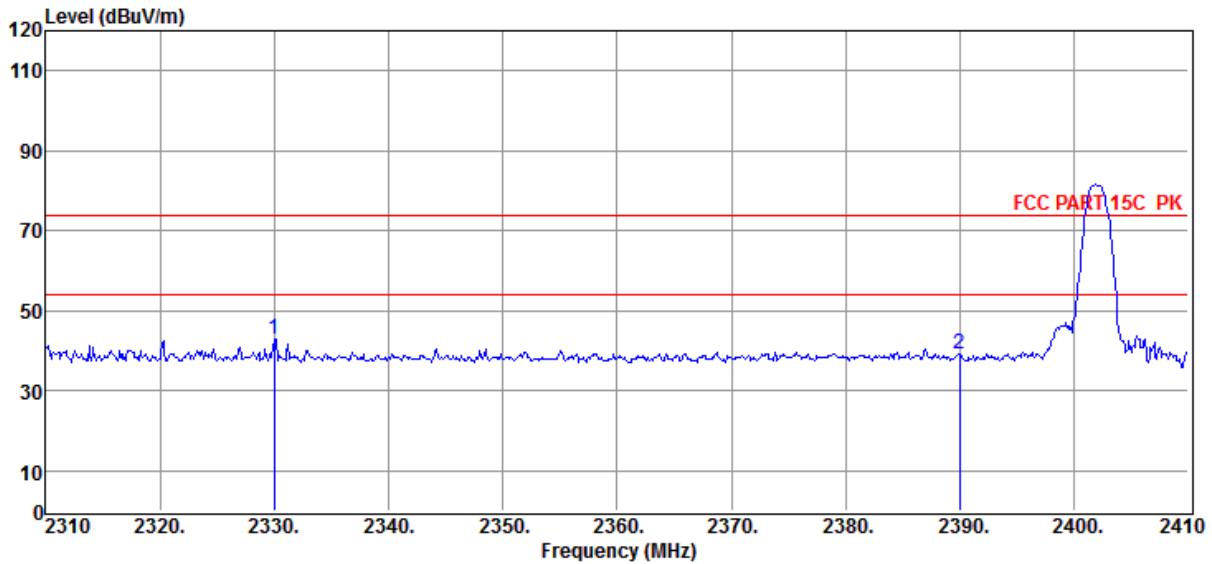

| Item (Mark) | Freq. (MHz) | Read Level (dBμV) | Antenna Factor (dB/m) | PRM Factor (dB) | Cable Loss (dB) | Result Level (dBμV/m) | Limit Line (dBμV/m) | Over Limit (dB) | Detector | Polarization |
|-------------|-------------|-------------------|-----------------------|-----------------|-----------------|-----------------------|---------------------|-----------------|----------|--------------|
| 1 | 2330.00 | 54.67 | 27.36 | 43.18 | 3.98 | 42.83 | 74.00 | -31.17 | Peak | VERTICAL |
| 2 | 2390.00 | 50.72 | 27.48 | 43.21 | 4.03 | 39.02 | 74.00 | -34.98 | Peak | VERTICAL |

Note: 1. Result Level = Read Level + Antenna Factor + Cable loss - PRM Factor.

2. If Peak Result complies with AV limit, AV Result is deemed to comply with AV limit.

3. Test setup: RBW: 1 MHz, VBW: 3 MHz, Sweep time: auto.

TR-4-E-009 Radiated Emission Test Result

Test Site : DDT 3m Chamber 2#
Test Date : 2020-10-23
EUT : HIGH-POWER BLUETOOTH-ENABLED SPEAKER SYSTEM WITH LIGHTS
Power Supply : AC 120V/60Hz
Condition : Temp:24.5°C,Humi:55%,Press:100.1kPa
Memo : DH5 2402

Tested By : Jacky
Model Number : Total PA Glow Max
Test Mode : Tx mode
Antenna/Distance : 2019 BBHA9120D/3m/HORIZONTAL

Data: 10

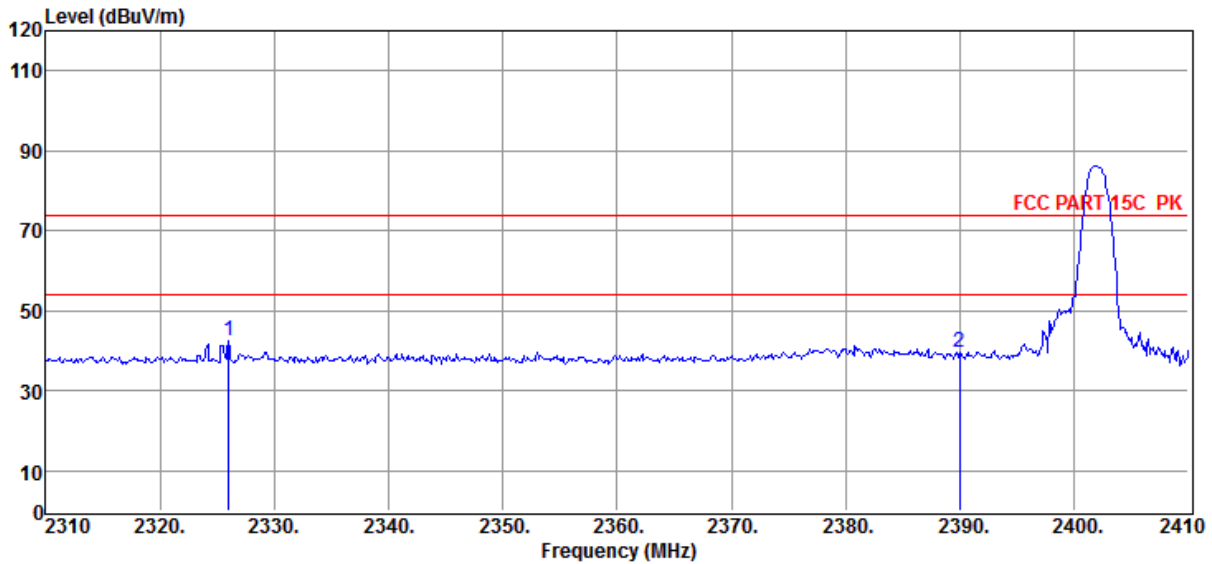

| Item (Mark) | Freq. (MHz) | Read Level (dBμV) | Antenna Factor (dB/m) | PRM Factor (dB) | Cable Loss (dB) | Result Level (dBμV/m) | Limit Line (dBμV/m) | Over Limit (dB) | Detector | Polarization |
|-------------|-------------|-------------------|-----------------------|-----------------|-----------------|-----------------------|---------------------|-----------------|----------|--------------|
| 1 | 2326.00 | 54.34 | 27.35 | 43.17 | 3.97 | 42.49 | 74.00 | -31.51 | Peak | HORIZONTAL |
| 2 | 2390.00 | 51.19 | 27.48 | 43.21 | 4.03 | 39.49 | 74.00 | -34.51 | Peak | HORIZONTAL |

- Note: 1. Result Level = Read Level + Antenna Factor + Cable loss - PRM Factor.
 2. If Peak Result complies with AV limit, AV Result is deemed to comply with AV limit.
 3. Test setup: RBW: 1 MHz, VBW: 3 MHz, Sweep time: auto.

TR-4-E-009 Radiated Emission Test Result

Test Site : DDT 3m Chamber 2#

D:\2020 RE2# Report Data\Q20092420-1E IPA145\FCC ABOVE1G.EM6

Test Date : 2020-10-23

Tested By : Jacky

EUT : HIGH-POWER BLUETOOTH-ENABLED SPEAKER SYSTEM WITH LIGHTS

Model Number : Total PA Glow Max

Power Supply : AC 120V/60Hz

Test Mode : Tx mode

Condition : Temp:24.5°C,Humi:55%,Press:100.1kPa

Antenna/Distance : 2019 BBHA9120D/3m/VERTICAL

Memo : DH5 2480

Data: 11

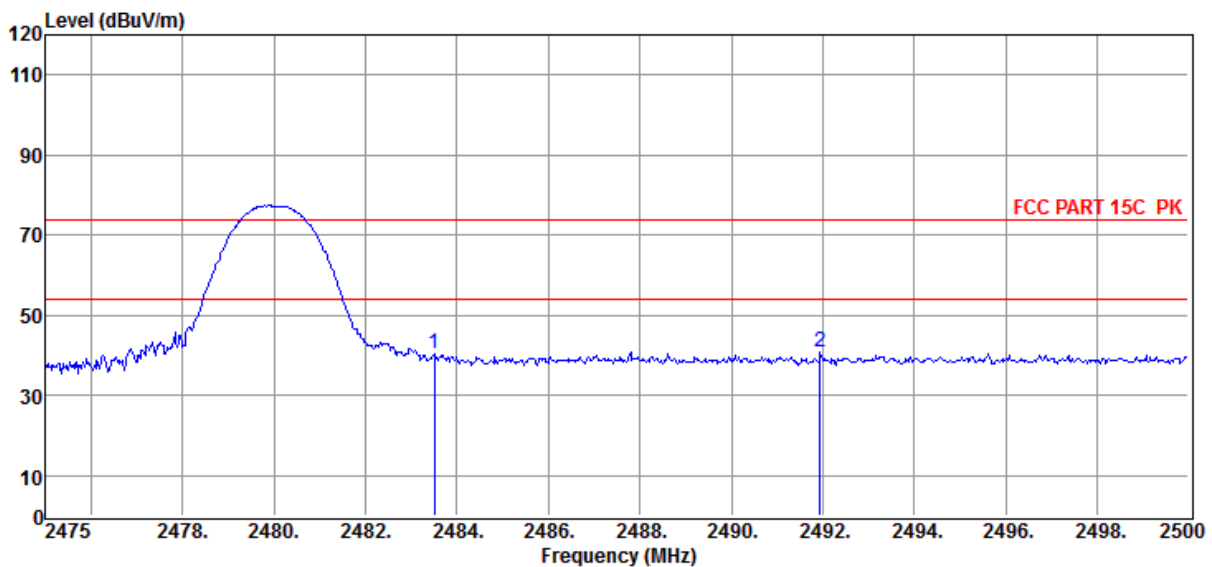

| Item (Mark) | Freq. (MHz) | Read Level (dBuV) | Antenna Factor (dB/m) | PRM Factor (dB) | Cable Loss (dB) | Result Level (dBuV/m) | Limit Line (dBuV/m) | Over Limit (dB) | Detector | Polarization |
|-------------|-------------|-------------------|-----------------------|-----------------|-----------------|-----------------------|---------------------|-----------------|----------|--------------|
| 1 | 2483.50 | 52.03 | 27.67 | 43.25 | 4.12 | 40.57 | 74.00 | -33.43 | Peak | VERTICAL |
| 2 | 2491.95 | 52.45 | 27.68 | 43.25 | 4.13 | 41.01 | 74.00 | -32.99 | Peak | VERTICAL |

Note: 1. Result Level = Read Level + Antenna Factor + Cable loss - PRM Factor.

2. If Peak Result complies with AV limit, AV Result is deemed to comply with AV limit.

3. Test setup: RBW: 1 MHz, VBW: 3 MHz, Sweep time: auto.

TR-4-E-009 Radiated Emission Test Result

Test Site : DDT 3m Chamber 2#

D:\2020 RE2# Report Data\Q20092420-1E IPA145\FCC ABOVE1G.EM6

Test Date : 2020-10-23

Tested By : Jacky

EUT : HIGH-POWER BLUETOOTH-ENABLED SPEAKER SYSTEM WITH LIGHTS

Model Number : Total PA Glow Max

Power Supply : AC 120V/60Hz

Test Mode : Tx mode

Condition : Temp:24.5°C,Humi:55%,Press:100.1kPa

Antenna/Distance : 2019 BBHA9120D/3m/HORIZONTAL

Memo : DH5 2480

Data: 12

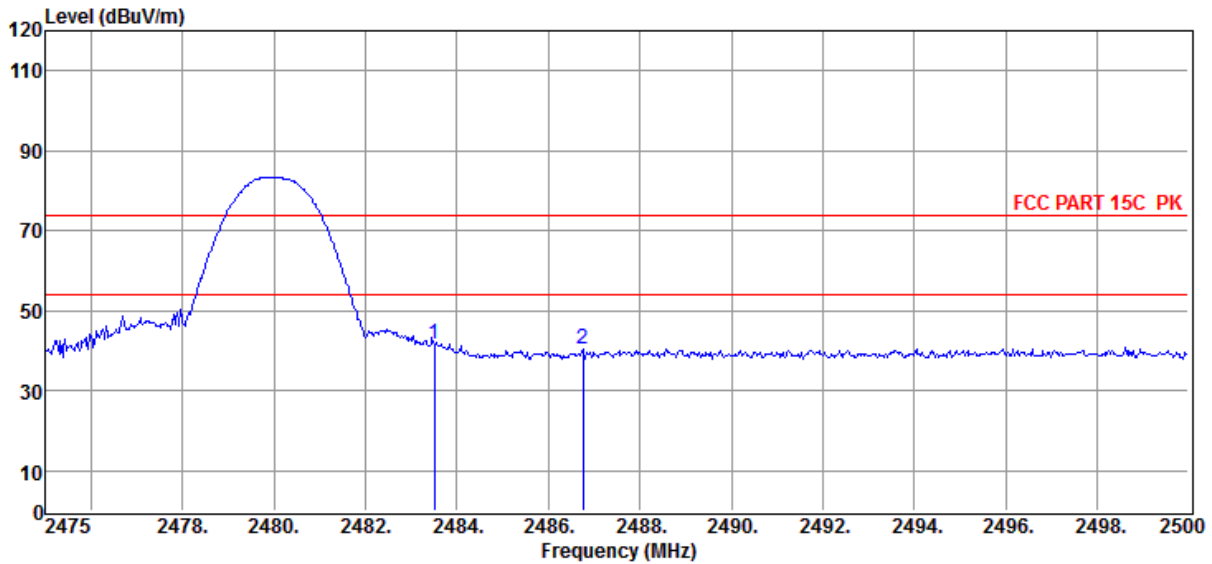

| Item (Mark) | Freq. (MHz) | Read Level (dBμV) | Antenna Factor (dB/m) | PRM Factor (dB) | Cable Loss (dB) | Result Level (dBμV/m) | Limit Line (dBμV/m) | Over Limit (dB) | Detector | Polarization |
|-------------|-------------|-------------------|-----------------------|-----------------|-----------------|-----------------------|---------------------|-----------------|----------|--------------|
| 1 | 2483.50 | 53.25 | 27.67 | 43.25 | 4.12 | 41.79 | 74.00 | -32.21 | Peak | HORIZONTAL |
| 2 | 2486.75 | 51.76 | 27.67 | 43.25 | 4.13 | 40.31 | 74.00 | -33.69 | Peak | HORIZONTAL |

Note: 1. Result Level = Read Level + Antenna Factor + Cable loss - PRM Factor.

2. If Peak Result complies with AV limit, AV Result is deemed to comply with AV limit.

3. Test setup: RBW: 1 MHz, VBW: 3 MHz, Sweep time: auto.

TR-4-E-009 Radiated Emission Test Result

Test Site : DDT 3m Chamber 2#

D:\2020 RE2# Report Data\Q20092420-1E IPA145\FCC ABOVE1G.EM6

Test Date : 2020-10-23

Tested By : Jacky

EUT : HIGH-POWER BLUETOOTH-ENABLED SPEAKER SYSTEM WITH LIGHTS

Model Number : Total PA Glow Max

Power Supply : AC 120V/60Hz

Test Mode : Tx mode

Condition : Temp:24.5°C,Humi:55%,Press:100.1kPa

Antenna/Distance : 2019 BBHA9120D/3m/VERTICAL

Memo : 2DH5 2402

Data: 13

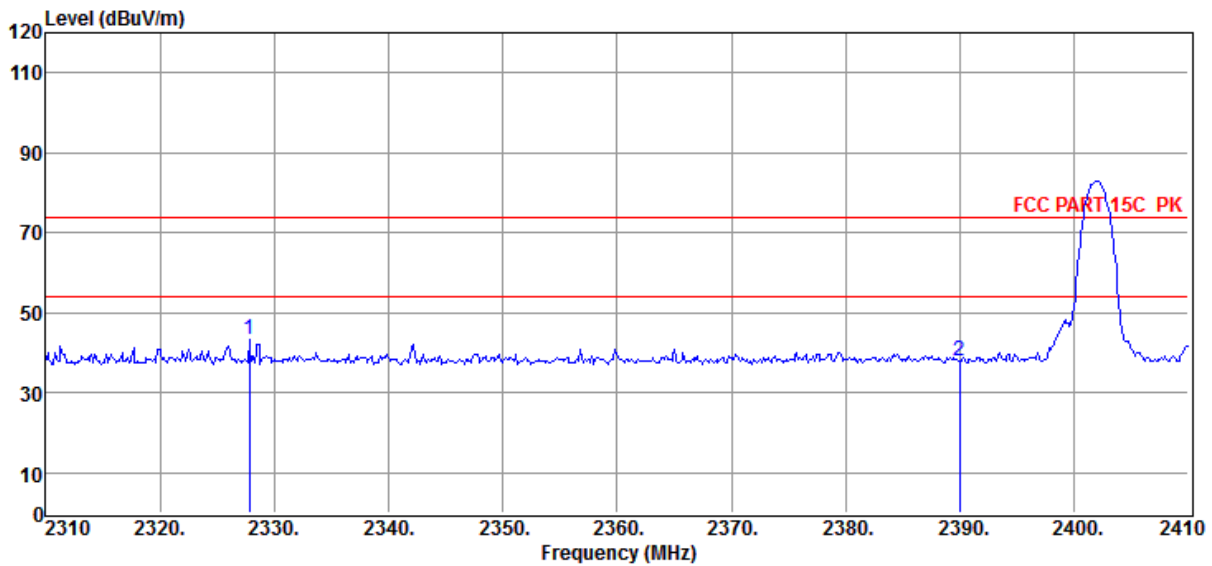

| Item (Mark) | Freq. (MHz) | Read Level (dBμV) | Antenna Factor (dB/m) | PRM Factor (dB) | Cable Loss (dB) | Result Level (dBμV/m) | Limit Line (dBμV/m) | Over Limit (dB) | Detector | Polarization |
|-------------|-------------|-------------------|-----------------------|-----------------|-----------------|-----------------------|---------------------|-----------------|----------|--------------|
| 1 | 2327.80 | 55.02 | 27.36 | 43.18 | 3.97 | 43.17 | 74.00 | -30.83 | Peak | VERTICAL |
| 2 | 2390.00 | 49.82 | 27.48 | 43.21 | 4.03 | 38.12 | 74.00 | -35.88 | Peak | VERTICAL |

Note: 1. Result Level = Read Level + Antenna Factor + Cable loss - PRM Factor.

2. If Peak Result complies with AV limit, AV Result is deemed to comply with AV limit.

3. Test setup: RBW: 1 MHz, VBW: 3 MHz, Sweep time: auto.

TR-4-E-009 Radiated Emission Test Result

Test Site : DDT 3m Chamber 2#

D:\2020 RE2# Report Data\Q20092420-1E IPA145\FCC ABOVE1G.EM6

Test Date : 2020-10-23

Tested By : Jacky

EUT : HIGH-POWER BLUETOOTH-ENABLED SPEAKER SYSTEM WITH LIGHTS

Model Number : Total PA Glow Max

Power Supply : AC 120V/60Hz

Test Mode : Tx mode

Condition : Temp:24.5°C,Humi:55%,Press:100.1kPa

Antenna/Distance : 2019 BBHA9120D/3m/HORIZONTAL

Memo : 2DH5 2402

Data: 14

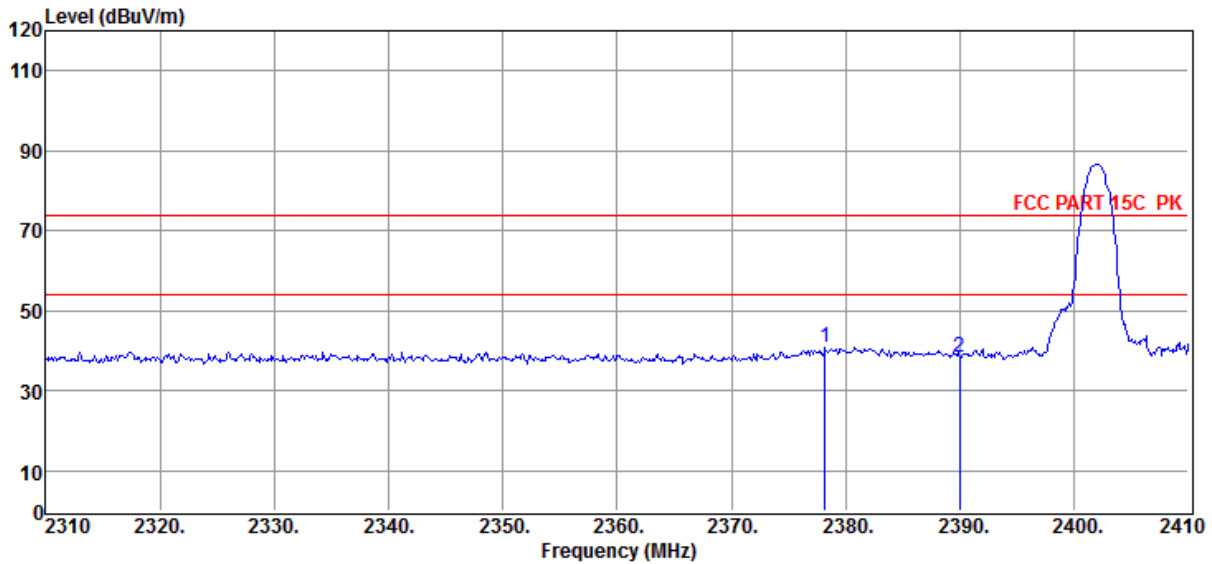

| Item (Mark) | Freq. (MHz) | Read Level (dBμV) | Antenna Factor (dB/m) | PRM Factor (dB) | Cable Loss (dB) | Result Level (dBμV/m) | Limit Line (dBμV/m) | Over Limit (dB) | Detector | Polarization |
|-------------|-------------|-------------------|-----------------------|-----------------|-----------------|-----------------------|---------------------|-----------------|----------|--------------|
| 1 | 2378.20 | 52.44 | 27.46 | 43.20 | 4.02 | 40.72 | 74.00 | -33.28 | Peak | HORIZONTAL |
| 2 | 2390.00 | 50.24 | 27.48 | 43.21 | 4.03 | 38.54 | 74.00 | -35.46 | Peak | HORIZONTAL |

Note: 1. Result Level = Read Level + Antenna Factor + Cable loss - PRM Factor.

2. If Peak Result complies with AV limit, AV Result is deemed to comply with AV limit.

3. Test setup: RBW: 1 MHz, VBW: 3 MHz, Sweep time: auto.

TR-4-E-009 Radiated Emission Test Result

Test Site : DDT 3m Chamber 2#

D:\2020 RE2# Report Data\Q20092420-1E IPA145\FCC ABOVE1G.EM6

Test Date : 2020-10-23

Tested By : Jacky

EUT : HIGH-POWER BLUETOOTH-ENABLED SPEAKER SYSTEM WITH LIGHTS

Model Number : Total PA Glow Max

Power Supply : AC 120V/60Hz

Test Mode : Tx mode

Condition : Temp:24.5°C,Humi:55%,Press:100.1kPa

Antenna/Distance : 2019 BBHA9120D/3m/VERTICAL

Memo : 2DH5 2480

Data: 15

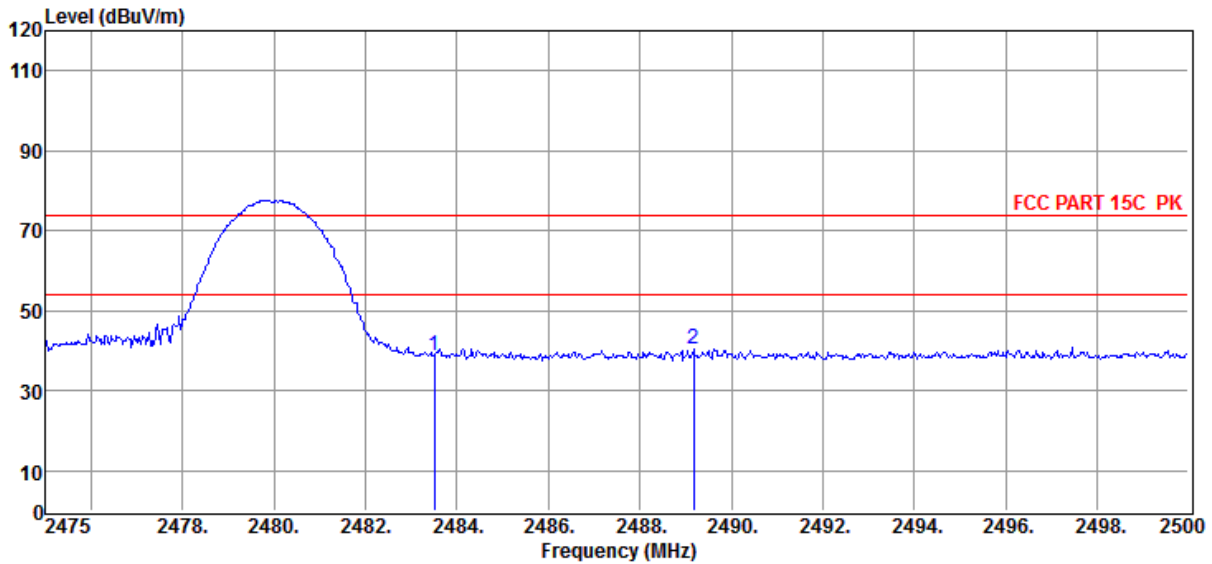

| Item (Mark) | Freq. (MHz) | Read Level (dBμV) | Antenna Factor (dB/m) | PRM Factor (dB) | Cable Loss (dB) | Result Level (dBμV/m) | Limit Line (dBμV/m) | Over Limit (dB) | Detector | Polarization |
|-------------|-------------|-------------------|-----------------------|-----------------|-----------------|-----------------------|---------------------|-----------------|----------|--------------|
| 1 | 2483.50 | 50.38 | 27.67 | 43.25 | 4.12 | 38.92 | 74.00 | -35.08 | Peak | VERTICAL |
| 2 | 2489.18 | 51.79 | 27.68 | 43.25 | 4.13 | 40.35 | 74.00 | -33.65 | Peak | VERTICAL |

Note: 1. Result Level = Read Level + Antenna Factor + Cable loss - PRM Factor.

2. If Peak Result complies with AV limit, AV Result is deemed to comply with AV limit.

3. Test setup: RBW: 1 MHz, VBW: 3 MHz, Sweep time: auto.

TR-4-E-009 Radiated Emission Test Result

Test Site : DDT 3m Chamber 2#

D:\2020 RE2# Report Data\Q20092420-1E IPA145\FCC ABOVE1G.EM6

Test Date : 2020-10-23

Tested By : Jacky

EUT : HIGH-POWER BLUETOOTH-ENABLED SPEAKER SYSTEM WITH LIGHTS

Model Number : Total PA Glow Max

Power Supply : AC 120V/60Hz

Test Mode : Tx mode

Condition : Temp:24.5°C,Humi:55%,Press:100.1kPa

Antenna/Distance : 2019 BBHA9120D/3m/HORIZONTAL

Memo : 2DH5 2480

Data: 16

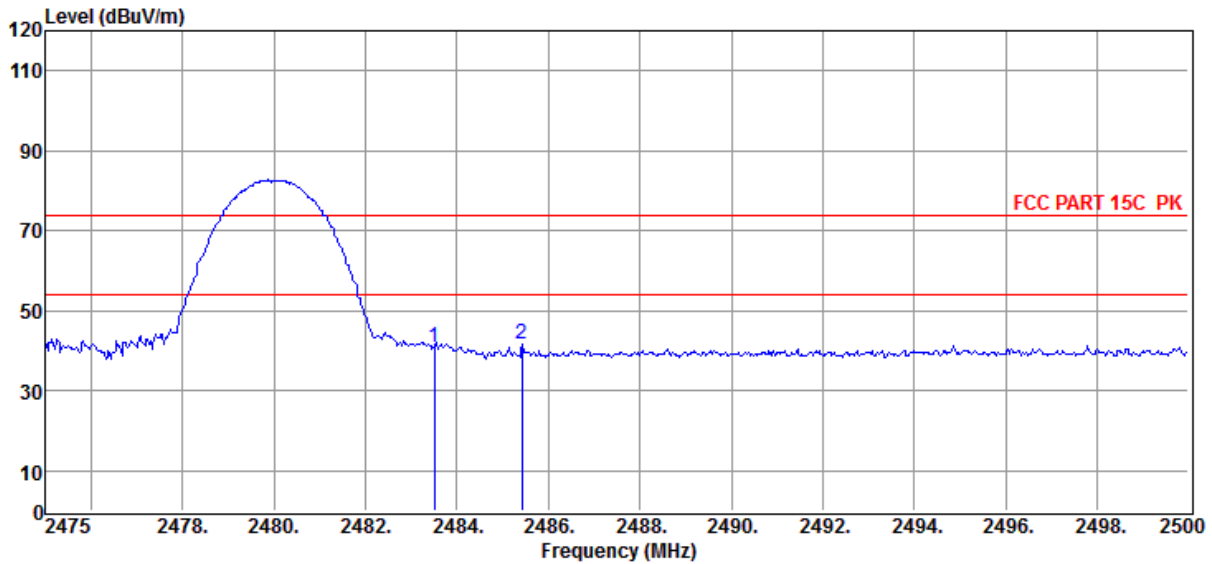

| Item (Mark) | Freq. (MHz) | Read Level (dBμV) | Antenna Factor (dB/m) | PRM Factor (dB) | Cable Loss (dB) | Result Level (dBμV/m) | Limit Line (dBμV/m) | Over Limit (dB) | Detector | Polarization |
|-------------|-------------|-------------------|-----------------------|-----------------|-----------------|-----------------------|---------------------|-----------------|----------|--------------|
| 1 | 2483.50 | 52.13 | 27.67 | 43.25 | 4.12 | 40.67 | 74.00 | -33.33 | Peak | HORIZONTAL |
| 2 | 2485.43 | 53.08 | 27.67 | 43.25 | 4.13 | 41.63 | 74.00 | -32.37 | Peak | HORIZONTAL |

Note: 1. Result Level = Read Level + Antenna Factor + Cable loss - PRM Factor.

2. If Peak Result complies with AV limit, AV Result is deemed to comply with AV limit.

3. Test setup: RBW: 1 MHz, VBW: 3 MHz, Sweep time: auto.

TR-4-E-009 Radiated Emission Test Result

Test Site : DDT 3m Chamber 2#

D:\2020 RE2# Report Data\Q20092420-1E IPA145\FCC ABOVE1G.EM6

Test Date : 2020-10-23

Tested By : Jacky

EUT : HIGH-POWER BLUETOOTH-ENABLED SPEAKER SYSTEM WITH LIGHTS

Model Number : Total PA Glow Max

Power Supply : AC 120V/60Hz

Test Mode : Tx mode

Condition : Temp:24.5°C,Humi:55%,Press:100.1kPa

Antenna/Distance : 2019 BBHA9120D/3m/VERTICAL

Memo : 3DH5 2402

Data: 17

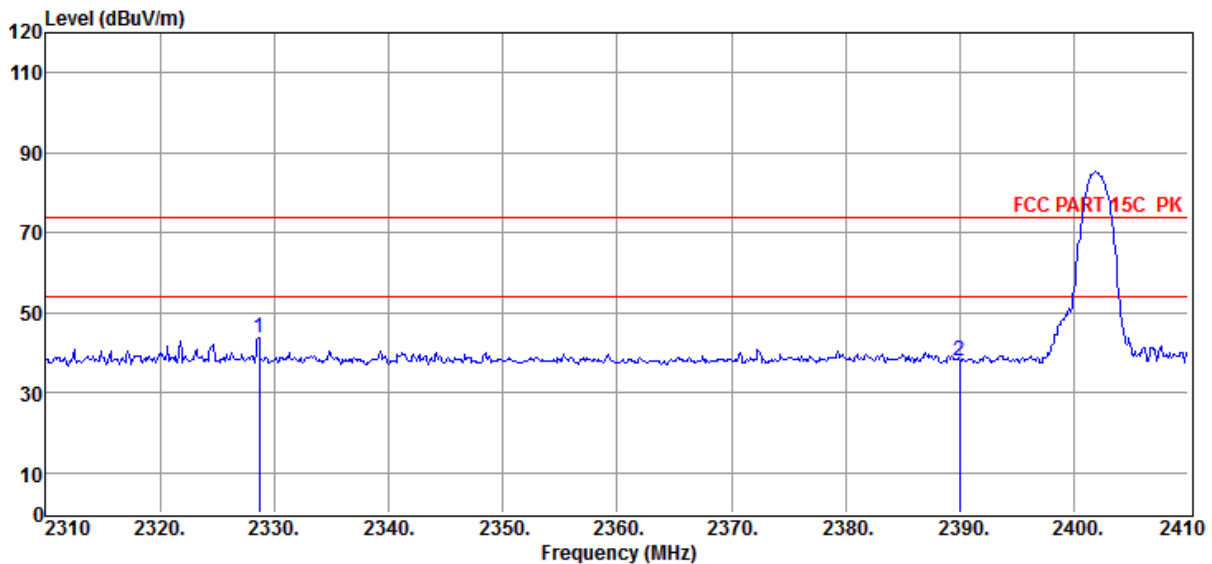

| Item (Mark) | Freq. (MHz) | Read Level (dBμV) | Antenna Factor (dB/m) | PRM Factor (dB) | Cable Loss (dB) | Result Level (dBμV/m) | Limit Line (dBμV/m) | Over Limit (dB) | Detector | Polarization |
|-------------|-------------|-------------------|-----------------------|-----------------|-----------------|-----------------------|---------------------|-----------------|----------|--------------|
| 1 | 2328.70 | 55.68 | 27.36 | 43.18 | 3.98 | 43.84 | 74.00 | -30.16 | Peak | VERTICAL |
| 2 | 2390.00 | 49.58 | 27.48 | 43.21 | 4.03 | 37.88 | 74.00 | -36.12 | Peak | VERTICAL |

Note: 1. Result Level = Read Level + Antenna Factor + Cable loss - PRM Factor.

2. If Peak Result complies with AV limit, AV Result is deemed to comply with AV limit.

3. Test setup: RBW: 1 MHz, VBW: 3 MHz, Sweep time: auto.

TR-4-E-009 Radiated Emission Test Result

Test Site : DDT 3m Chamber 2#

D:\2020 RE2# Report Data\Q20092420-1E IPA145\FCC ABOVE1G.EM6

Test Date : 2020-10-23

Tested By : Jacky

EUT : HIGH-POWER BLUETOOTH-ENABLED SPEAKER SYSTEM WITH LIGHTS

Model Number : Total PA Glow Max

Power Supply : AC 120V/60Hz

Test Mode : Tx mode

Condition : Temp:24.5°C,Humi:55%,Press:100.1kPa

Antenna/Distance : 2019 BBHA9120D/3m/HORIZONTAL

Memo : 3DH5 2402

Data: 18

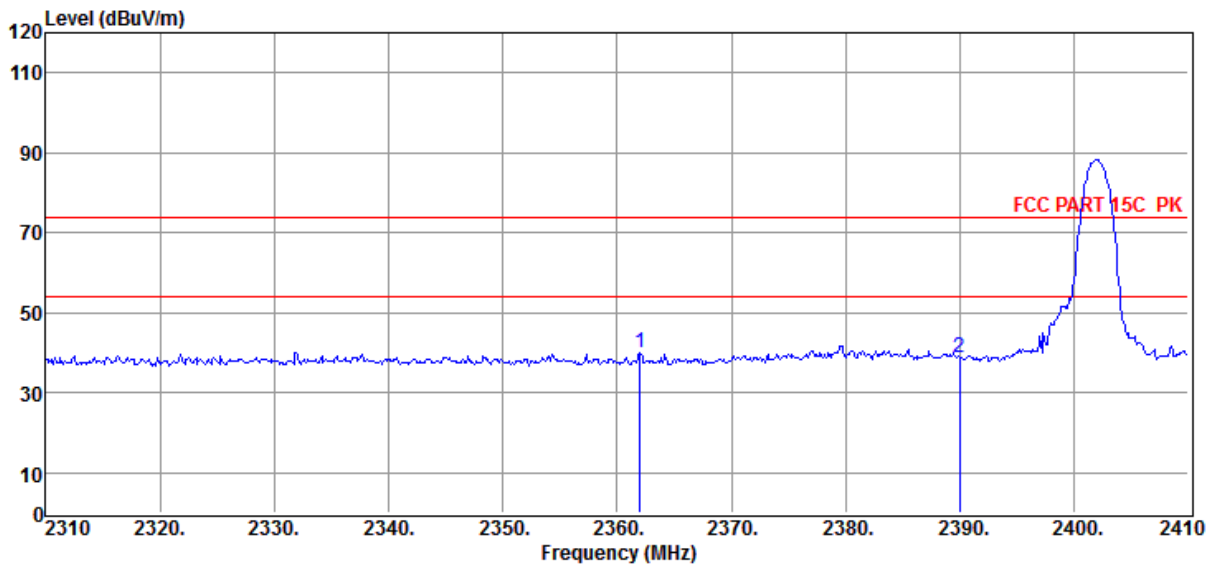

| Item (Mark) | Freq. (MHz) | Read Level (dBμV) | Antenna Factor (dB/m) | PRM Factor (dB) | Cable Loss (dB) | Result Level (dBμV/m) | Limit Line (dBμV/m) | Over Limit (dB) | Detector | Polarization |
|-------------|-------------|-------------------|-----------------------|-----------------|-----------------|-----------------------|---------------------|-----------------|----------|--------------|
| 1 | 2362.00 | 51.92 | 27.42 | 43.19 | 4.01 | 40.16 | 74.00 | -33.84 | Peak | HORIZONTAL |
| 2 | 2390.00 | 50.62 | 27.48 | 43.21 | 4.03 | 38.92 | 74.00 | -35.08 | Peak | HORIZONTAL |

Note: 1. Result Level = Read Level + Antenna Factor + Cable loss - PRM Factor.

2. If Peak Result complies with AV limit, AV Result is deemed to comply with AV limit.

3. Test setup: RBW: 1 MHz, VBW: 3 MHz, Sweep time: auto.

TR-4-E-009 Radiated Emission Test Result

Test Site : DDT 3m Chamber 2#

D:\2020 RE2# Report Data\Q20092420-1E IPA145\FCC ABOVE1G.EM6

Test Date : 2020-10-23

Tested By : Jacky

EUT : HIGH-POWER BLUETOOTH-ENABLED SPEAKER SYSTEM WITH LIGHTS

Model Number : Total PA Glow Max

Power Supply : AC 120V/60Hz

Test Mode : Tx mode

Condition : Temp:24.5°C,Humi:55%,Press:100.1kPa

Antenna/Distance : 2019 BBHA9120D/3m/VERTICAL

Memo : 3DH5 2480

Data: 19

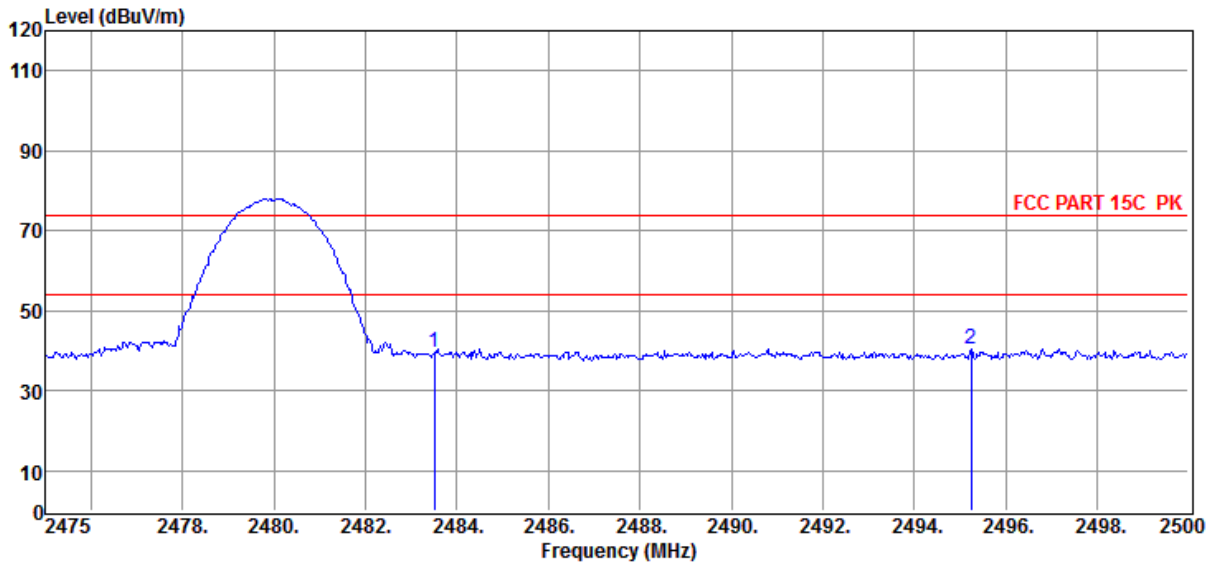

| Item (Mark) | Freq. (MHz) | Read Level (dBμV) | Antenna Factor (dB/m) | PRM Factor (dB) | Cable Loss (dB) | Result Level (dBμV/m) | Limit Line (dBμV/m) | Over Limit (dB) | Detector | Polarization |
|-------------|-------------|-------------------|-----------------------|-----------------|-----------------|-----------------------|---------------------|-----------------|----------|--------------|
| 1 | 2483.50 | 51.04 | 27.67 | 43.25 | 4.12 | 39.58 | 74.00 | -34.42 | Peak | VERTICAL |
| 2 | 2495.25 | 51.99 | 27.69 | 43.26 | 4.14 | 40.56 | 74.00 | -33.44 | Peak | VERTICAL |

Note: 1. Result Level = Read Level + Antenna Factor + Cable loss - PRM Factor.

2. If Peak Result complies with AV limit, AV Result is deemed to comply with AV limit.

3. Test setup: RBW: 1 MHz, VBW: 3 MHz, Sweep time: auto.

TR-4-E-009 Radiated Emission Test Result

Test Site : DDT 3m Chamber 2#
Test Date : 2020-10-23
EUT : HIGH-POWER BLUETOOTH-ENABLED SPEAKER SYSTEM WITH LIGHTS
Power Supply : AC 120V/60Hz
Condition : Temp:24.5°C,Humi:55%,Press:100.1kPa
Memo : 3DH5 2480

D:\2020 RE2# Report Data\Q20092420-1E IPA145\FCC ABOVE1G.EM6
Tested By : Jacky
Model Number : Total PA Glow Max
Test Mode : Tx mode
Antenna/Distance : 2019 BBHA9120D/3m/HORIZONTAL

Data: 20

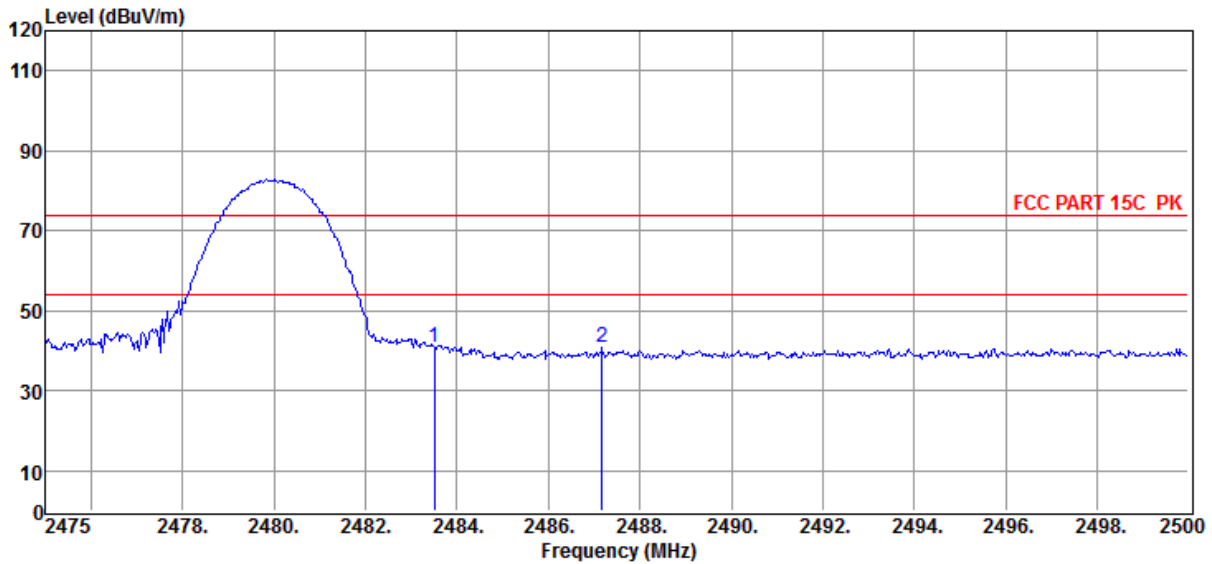

| Item (Mark) | Freq. (MHz) | Read Level (dBμV) | Antenna Factor (dB/m) | PRM Factor (dB) | Cable Loss (dB) | Result Level (dBμV/m) | Limit Line (dBμV/m) | Over Limit (dB) | Detector | Polarization |
|-------------|-------------|-------------------|-----------------------|-----------------|-----------------|-----------------------|---------------------|-----------------|----------|--------------|
| 1 | 2483.50 | 52.46 | 27.67 | 43.25 | 4.12 | 41.00 | 74.00 | -33.00 | Peak | HORIZONTAL |
| 2 | 2487.18 | 52.15 | 27.67 | 43.25 | 4.13 | 40.70 | 74.00 | -33.30 | Peak | HORIZONTAL |

- Note: 1. Result Level = Read Level + Antenna Factor + Cable loss - PRM Factor.
 2. If Peak Result complies with AV limit, AV Result is deemed to comply with AV limit.
 3. Test setup: RBW: 1 MHz, VBW: 3 MHz, Sweep time: auto.

13. Power Line Conducted Emission

13.1. Block diagram of test setup

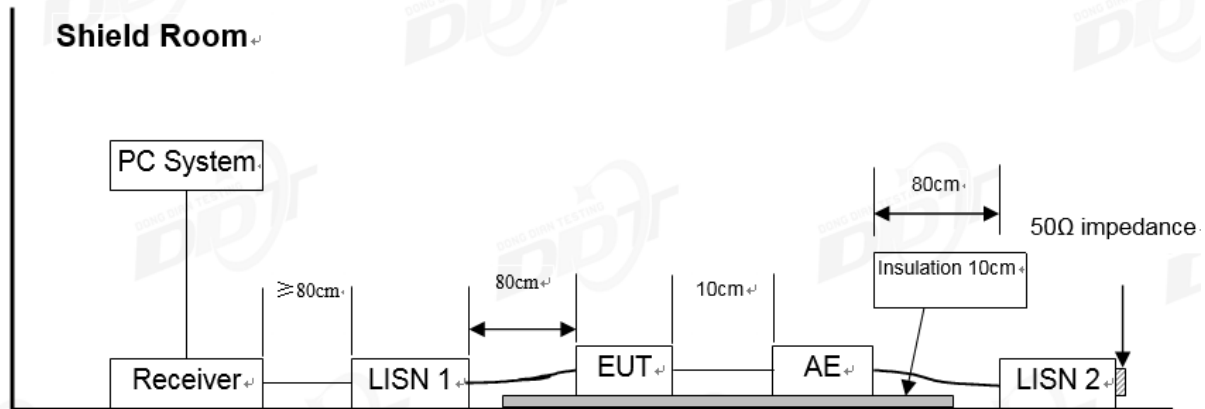

13.2. Power line conducted emission limits

| Frequency | Quasi-Peak Level dB(μ V) | Average Level dB(μ V) |
|-------------------|----------------------------------|-------------------------------|
| 150 kHz ~ 500 kHz | 66 ~ 56* | 56 ~ 46* |
| 500 kHz ~ 5 MHz | 56 | 46 |
| 5 MHz ~ 30 MHz | 60 | 50 |

Note 1: * Decreasing linearly with logarithm of frequency.

Note 2: The lower limit shall apply at the transition frequencies.

13.3. Test procedure

The EUT and Support equipment, if needed, were put placed on a non-metallic table, 80cm above the ground plane.

Configuration EUT to simulate typical usage as described in clause 2.4 and test equipment as described in clause 3 of this report.

All I/O cables were positioned to simulate typical actual usage as per ANSI C63.10.

All support equipment power received from a second LISN.

Emissions were measured on each current carrying line of the EUT using an EMI Test Receiver connected to the LISN powering the EUT.

The Receiver scanned from 150 kHz to 30 MHz for emissions in each of the test modes.

During the above scans, the emissions were maximized by cable manipulation.

The test mode(s) described in clause 2.4 were scanned during the preliminary test.

After the preliminary scan, we found the test mode producing the highest emission level.

The EUT configuration and worse cable configuration of the above highest emission levels were recorded for reference of the final test.

EUT and support equipment were set up on the test bench as per the configuration with highest

emission level in the preliminary test.

A scan was taken on both power lines, Neutral and Line, recording at least the six highest emissions.

Emission frequency and amplitude were recorded into a computer in which correction factors were used to calculate the emission level and compare reading to the applicable limit.

The test data of the worst-case condition(s) was recorded.

The bandwidth of test receiver is set at 9 kHz.

13.4. Test result

Pass. (See below detailed test result)

Note1: All emissions not reported below are too low against the prescribed limits.

Note2: "----" means Peak detection; "----" means Average detection.

Note3: Pre-test AC conducted emission at both voltage AC 120V/60Hz and AC 240V/50Hz, recorded worse case.

TR-4-E-010 Conducted Emission Test Result

Test Site : DDT 5# Shield Room
Test Date : 2020-11-10
EUT : HIGH-POWER BLUETOOTH-ENABLED SPEAKER SYSTEM WITH LIGHTS
Power Supply : AC 120V/60Hz
Condition : Temp:24.5°C,Humi:55.5%,Press:101.4kPa
Memo :

D:\2020 report data\Q20101602-1E\CE.EM6
Tested By : Caesar Peng
Model Number : Total PA Glow Max
Test Mode : Tx mode
LISN : 2019 ENV216 2#/LINE

Data: 26

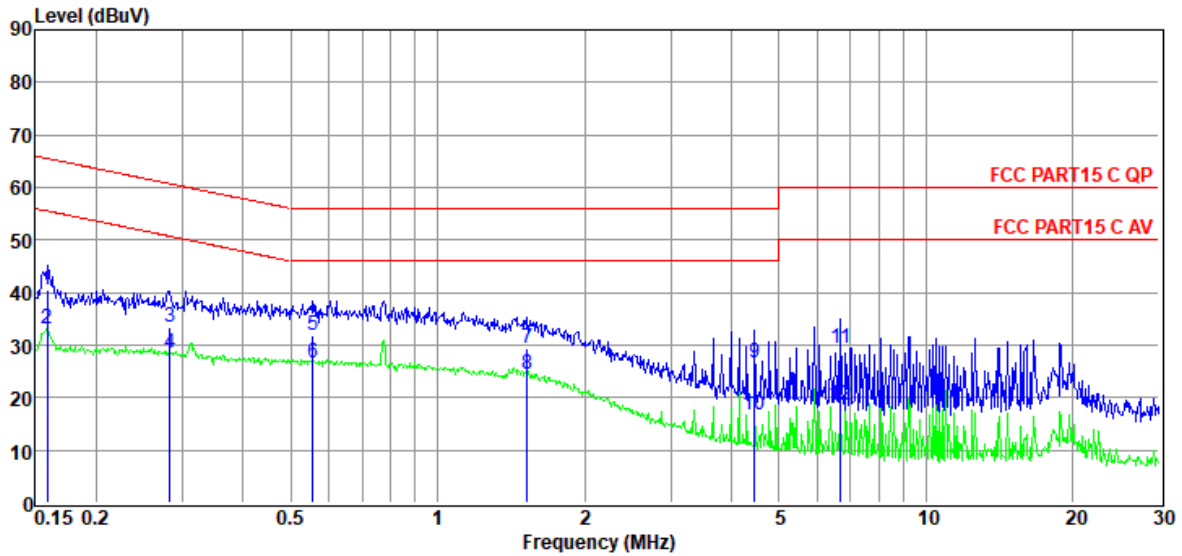

| Item (Mark) | Freq. (MHz) | Read Level (dBμV) | LISN Factor (dB) | Cable Loss (dB) | Pulse Limiter Factor (dB) | Result Level (dBμV) | Limit Line (dBμV) | Over Limit (dB) | Detector | Phase |
|-------------|-------------|-------------------|------------------|-----------------|---------------------------|---------------------|-------------------|-----------------|----------|-------|
| 1 | 0.16 | 20.81 | 9.60 | 0.03 | 10.01 | 40.45 | 65.52 | -25.07 | QP | LINE |
| 2 | 0.16 | 13.37 | 9.60 | 0.03 | 10.01 | 33.01 | 55.52 | -22.51 | Average | LINE |
| 3 | 0.28 | 13.89 | 9.60 | 0.03 | 10.01 | 33.53 | 60.72 | -27.19 | QP | LINE |
| 4 | 0.28 | 8.74 | 9.60 | 0.03 | 10.01 | 28.38 | 50.72 | -22.34 | Average | LINE |
| 5 | 0.56 | 12.22 | 9.60 | 0.04 | 10.01 | 31.87 | 56.00 | -24.13 | QP | LINE |
| 6 | 0.56 | 6.98 | 9.60 | 0.04 | 10.01 | 26.63 | 46.00 | -19.37 | Average | LINE |
| 7 | 1.53 | 9.79 | 9.60 | 0.07 | 10.01 | 29.47 | 56.00 | -26.53 | QP | LINE |
| 8 | 1.53 | 4.79 | 9.60 | 0.07 | 10.01 | 24.47 | 46.00 | -21.53 | Average | LINE |
| 9 | 4.45 | 6.97 | 9.60 | 0.12 | 10.01 | 26.70 | 56.00 | -29.30 | QP | LINE |
| 10 | 4.45 | -3.05 | 9.60 | 0.12 | 10.01 | 16.68 | 46.00 | -29.32 | Average | LINE |
| 11 | 6.70 | 9.64 | 9.60 | 0.15 | 10.01 | 29.40 | 60.00 | -30.60 | QP | LINE |
| 12 | 6.70 | -1.12 | 9.60 | 0.15 | 10.01 | 18.64 | 50.00 | -31.36 | Average | LINE |

Note:

1. Result Level = Read Level + LISN Factor + Pulse Limiter Factor + Cable loss.
2. If QP Result complies with AV limit, AV Result is deemed to comply with AV limit.
3. Test setup: RBW: 200 Hz (9 kHz—150 kHz), 9 kHz (150 kHz—30 MHz).
4. Step size: 80Hz (0.009MHz-0.15MHz), 4 kHz (0.15MHz-30MHz), Scan time: auto.

TR-4-E-010 Conducted Emission Test Result

Test Site : DDT 5# Shield Room
Test Date : 2020-11-10
EUT : HIGH-POWER BLUETOOTH-ENABLED SPEAKER SYSTEM WITH LIGHTS
Power Supply : AC 120V/60Hz
Condition : Temp:24.5°C,Humi:55.5%,Press:101.4kPa
Memo :

D:\2020 report data\Q20101602-1E\CE.EM6
Tested By : Caesar Peng
Model Number : Total PA Glow Max
Test Mode : Tx mode
LISN : 2019 ENV216 2#/NEUTRAL

Data: 28

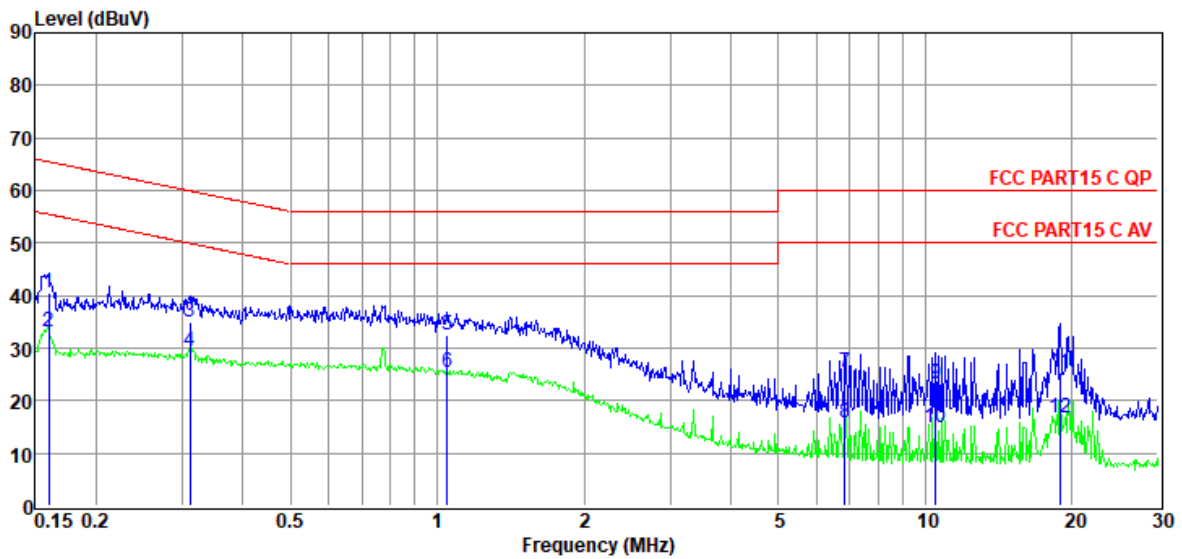

| Item (Mark) | Freq. (MHz) | Read Level (dBμV) | LISN Factor (dB) | Cable Loss (dB) | Pulse Limiter Factor (dB) | Result Level (dBμV) | Limit Line (dBμV) | Over Limit (dB) | Detector | Phase |
|-------------|-------------|-------------------|------------------|-----------------|---------------------------|---------------------|-------------------|-----------------|----------|---------|
| 1 | 0.16 | 20.98 | 9.60 | 0.03 | 10.01 | 40.62 | 65.47 | -24.85 | QP | NEUTRAL |
| 2 | 0.16 | 13.53 | 9.60 | 0.03 | 10.01 | 33.17 | 55.47 | -22.30 | Average | NEUTRAL |
| 3 | 0.31 | 15.23 | 9.60 | 0.03 | 10.01 | 34.87 | 59.93 | -25.06 | QP | NEUTRAL |
| 4 | 0.31 | 9.74 | 9.60 | 0.03 | 10.01 | 29.38 | 49.93 | -20.55 | Average | NEUTRAL |
| 5 | 1.05 | 12.90 | 9.60 | 0.05 | 10.01 | 32.56 | 56.00 | -23.44 | QP | NEUTRAL |
| 6 | 1.05 | 5.81 | 9.60 | 0.05 | 10.01 | 25.47 | 46.00 | -20.53 | Average | NEUTRAL |
| 7 | 6.84 | 5.75 | 9.60 | 0.15 | 10.01 | 25.51 | 60.00 | -34.49 | QP | NEUTRAL |
| 8 | 6.84 | -4.08 | 9.60 | 0.15 | 10.01 | 15.68 | 50.00 | -34.32 | Average | NEUTRAL |
| 9 | 10.51 | 3.38 | 9.70 | 0.19 | 10.01 | 23.28 | 60.00 | -36.72 | QP | NEUTRAL |
| 10 | 10.51 | -5.02 | 9.70 | 0.19 | 10.01 | 14.88 | 50.00 | -35.12 | Average | NEUTRAL |
| 11 | 18.92 | 5.22 | 9.78 | 0.24 | 10.02 | 25.26 | 60.00 | -34.74 | QP | NEUTRAL |
| 12 | 18.92 | -3.32 | 9.78 | 0.24 | 10.02 | 16.72 | 50.00 | -33.28 | Average | NEUTRAL |

Note:

1. Result Level = Read Level + LISN Factor + Pulse Limiter Factor + Cable loss.
2. If QP Result complies with AV limit, AV Result is deemed to comply with AV limit.
3. Test setup: RBW: 200 Hz (9 kHz—150 kHz), 9 kHz (150 kHz—30 MHz).
4. Step size: 80Hz (0.009MHz-0.15MHz), 4 kHz (0.15MHz-30MHz), Scan time: auto.

14. Antenna Requirements

14.1. Limit

For intentional device, according to FCC 47 CFR Section 15.203, an intentional radiator shall be designed to ensure that no antenna other than that furnished by the responsible party shall be used with the device. And according to FCC 47 CFR Section 15.247 (b), if transmitting antennas of directional gain greater than 6 dBi are used, the power shall be reduced by the amount in dB that the directional gain of the antenna exceeds 6 dBi.

14.2. Result

The antenna used for this product is Integral PCB antenna and that no antenna other than that furnished by the responsible party shall be used with the device, the maximum peak gain is -0.58 dBi.

END OF REPORT