

TEST REPORT

Applicant: Anker Innovations Limited

Address: Room 1318-19, Hollywood Plaza, 610 Nathan Road, Mongkok, Kowloon, Hong Kong

Product Name: Indoor Cam C220, Indoor Cam C210

FCC ID: 2AOKB-T8W11C

Standard(s): 47 CFR Part 15, Subpart C(15.247)
ANSI C63.10-2013
KDB 558074 D01 15.247 Meas Guidance v05r02

Report Number: DG2231214-75516E-RF-00B

Report Date: 2024/1/17

The above device has been tested and found compliant with the requirement of the relative standards by Bay Area Compliance Laboratories Corp. (Dongguan).

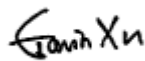

Reviewed By: Gavin Xu
Title: RF Engineer



Approved By: Ivan Cao
Title: EMC Manager

Bay Area Compliance Laboratories Corp. (Dongguan)
No.12, Pulong East 1st Road, Tangxia Town, Dongguan, Guangdong, China

Tel: +86-769-86858888
Fax: +86-769-86858891

www.baclcorp.com.cn

Note: The information marked ▲ is provided by the applicant, the laboratory is not responsible for its authenticity and this information can affect the validity of the result in the test report. Unless otherwise stated the results shown in this test report refer only to the sample(s) tested. This report cannot be reproduced except in full, without prior written approval of the Company. This report is valid only with a valid digital signature. The digital signature may be available only under the Adobe software above version 7.0. This report may contain data that are not covered by the accreditation scope and shall be marked with ★. This report must not be used by the client to claim product certification, approval, or endorsement by NVLAP, NIST, or any agency of the U.S. Government.

CONTENTS

DOCUMENT REVISION HISTORY	4
1. GENERAL INFORMATION	5
1.1 PRODUCT DESCRIPTION FOR EQUIPMENT UNDER TEST (EUT)	5
1.2 ACCESSORY INFORMATION.....	5
1.3 ANTENNA INFORMATION DETAIL▲.....	5
1.4 EQUIPMENT MODIFICATIONS	5
2. DESCRIPTION OF TEST CONFIGURATION	6
2.1 OPERATION FREQUENCY DETAIL.....	6
2.2 EUT OPERATION CONDITION.....	6
2.3 EUT EXERCISE SOFTWARE.....	6
2.4 SUPPORT EQUIPMENT LIST AND DETAILS	6
2.5 SUPPORT CABLE LIST AND DETAILS	7
2.6 BLOCK DIAGRAM OF TEST SETUP	7
2.7 TEST FACILITY.....	9
2.8 MEASUREMENT UNCERTAINTY	9
3. SUMMARY OF TEST RESULTS	10
4. REQUIREMENTS AND TEST PROCEDURES	11
4.1 AC LINE CONDUCTED EMISSIONS.....	11
4.1.1 Applicable Standard.....	11
4.1.2 EUT Setup.....	12
4.1.3 EMI Test Receiver Setup	12
4.1.4 Test Procedure	13
4.1.5 Corrected Amplitude & Margin Calculation.....	13
4.1.6 Test Result	13
4.2 RADIATION SPURIOUS EMISSIONS	14
4.2.1 Applicable Standard.....	14
4.2.2 EUT Setup.....	14
4.2.3 EMI Test Receiver & Spectrum Analyzer Setup	16
4.2.4 Test Procedure	16
4.2.5 Corrected Result & Margin Calculation	16
4.2.6 Test Result	16
4.3 MINIMUM 6 DB EMISSION BANDWIDTH	17
4.3.1 Applicable Standard.....	17
4.3.2 EUT Setup.....	17
4.3.3 Test Procedure	17
4.3.4 Test Result	17
4.4 99% OCCUPIED BANDWIDTH.....	18
4.4.1 EUT Setup.....	18
4.4.2 Test Procedure	18
4.4.3 Test Result	18

4.5 MAXIMUM CONDUCTED OUTPUT POWER..... 19

 4.5.1 Applicable Standard..... 19

 4.5.2 EUT Setup..... 19

 4.5.3 Test Procedure 19

 4.5.4 Test Result 19

4.6 MAXIMUM POWER SPECTRAL DENSITY 20

 4.6.1 Applicable Standard..... 20

 4.6.2 EUT Setup..... 20

 4.6.3 Test Procedure 20

 4.6.4 Test Result 20

4.7 100 KHZ BANDWIDTH OF FREQUENCY BAND EDGE..... 21

 4.7.1 Applicable Standard..... 21

 4.7.2 EUT Setup..... 21

 4.7.3 Test Procedure 21

 4.7.4 Test Result 21

4.8 DUTY CYCLE 22

 4.8.1 EUT Setup..... 22

 4.8.2 Test Procedure 22

 4.8.3 Judgment..... 22

4.9 ANTENNA REQUIREMENT..... 23

 4.9.1 Applicable Standard..... 23

 4.9.2 Judgment..... 23

5. Test DATA AND RESULTS 24

5.1 AC LINE CONDUCTED EMISSIONS..... 24

5.2 RADIATION SPURIOUS EMISSIONS 27

5.3 MINIMUM 6 DB EMISSION BANDWIDTH 49

5.4 99% OCCUPIED BANDWIDTH..... 51

5.5 MAXIMUM CONDUCTED OUTPUT POWER..... 53

5.6 MAXIMUM POWER SPECTRAL DENSITY 54

5.7 100 KHZ BANDWIDTH OF FREQUENCY BAND EDGE: 56

5.8 DUTY CYCLE: 58

6. EUT PHOTOGRAPHS 60

7. TEST SETUP PHOTOGRAPHS 61

Appendix A. RF EXPOSURE EVALUATION..... 62

APPLICABLE STANDARD..... 62

CALCULATION FORMULA: 62

CALCULATED DATA: 62

DOCUMENT REVISION HISTORY

Revision Number	Report Number	Description of Revision	Date of Revision
1.0	DG2231214-75516E-RF-00B	Original Report	2024/1/17

1. GENERAL INFORMATION

1.1 Product Description for Equipment under Test (EUT)

EUT Name:	Indoor Cam C220, Indoor Cam C210
EUT Model:	T8W11C
Multiple Models:	T8419
Operation Frequency:	2412-2462MHz (802.11b/g/n ht20)
Maximum Peak Output Power (Conducted):	23.449dBm
Modulation Type:	802.11b:DSSS-DBPSK, DQPSK, CCK 802.11g/n: OFDM-BPSK, QPSK, 16QAM, 64QAM
Rated Input Voltage:	DC 5V from adapter
Serial Number:	Radiated Spurious Emission: 2F7I-7(Model: T8W11C) 2F7I-10(Model: T8419) AC Power Lines Conducted Emission: 2F7I-7(Model: T8W11C) RF Conducted: 2F7I-8(Model: T8W11C)
EUT Received Date:	2023/11/24
EUT Received Status:	Good
<p>Note: The Multiple models are electrically identical with the test model. Please refer to the declaration letter for more detail, which was provided by manufacturer. Model: T8W11C was tested except Radiated Spurious Emission below 1GHz was tested both models.</p>	

1.2 Accessory Information

Accessory Description	Manufacturer	Model	Parameters
Adapter	Shenzhen ShiAn Power Technology Co.,Ltd.	SA0101-0501000UA	Input: 100-240~50-60Hz 0.35A MAX Output: DC5.0V 1.0A 5W

1.3 Antenna Information Detail ▲

Antenna Manufacturer	Antenna Type	input impedance (Ohm)	Frequency Range	Antenna Gain
Dongguan Youbi Electronics Co., Ltd	PIFA	50	2.4~2.5GHz	3.18 dBi
<p>The Method of §15.203 Compliance: <input checked="" type="checkbox"/> Antenna was permanently attached to the unit. <input type="checkbox"/> Antenna uses a unique type of connector to attach to the EUT. <input type="checkbox"/> Unit was professionally installed, and installer shall be responsible for verifying that the correct antenna is employed with the unit.</p>				

1.4 Equipment Modifications

No modifications are made to the EUT during all test items.

2. DESCRIPTION OF TEST CONFIGURATION

2.1 Operation Frequency Detail

For 802.11b/g/n ht20:

Channel	Frequency (MHz)	Channel	Frequency (MHz)
1	2412	7	2442
2	2417	8	2447
3	2422	9	2452
4	2427	10	2457
5	2432	11	2462
6	2437	/	/

2.2 EUT Operation Condition

The system was configured for testing in Engineering Mode, which was provided by the manufacturer. The following summary table is showing all test modes to demonstrate in compliance with the standard:

Test Items	Test Modes
RF Conducted	Mode 1: Transmitting 802.11b
	Mode 2: Transmitting 802.11g
	Mode 3: Transmitting 802.11n ht20
Radiated Spurious Emission	Mode 1: Transmitting 802.11b
	Mode 2: Transmitting 802.11g
	Mode 3: Transmitting 802.11n ht20
AC Line Conducted Emission	Test was performed at the channel and mode with maximum output power
Note: Mode 1, mode 2, mode 3 were tested with the frequencies in bold in section 2.1.	

2.3 EUT Exercise Software

EUT Exercise Software:		iwconfig		
The software was provided by manufacturer. The maximum power was configured as below, that was provided by the manufacturer ▲ :				
Test Modes	Data Rate	Power Level Setting		
		Low Channel	Middle Channel	High Channel
802.11b	1Mbps	18	18	18
802.11g	6Mbps	18	18	18
802.11n ht20	MCS0	18	18	18
The above are the worst-case data rates, which are determined for each mode based upon investigations by measuring the average power and PSD across all data rates, bandwidths, and modulations.				

2.4 Support Equipment List and Details

Manufacturer	Description	Model	Serial Number
SanDisk	SD Card	32 GB	521005904698

2.5 Support Cable List and Details

Cable Description	Shielding Type	Ferrite Core	Length (m)	From Port	To
DC Cable	No	No	2.0	Adapter	EUT

2.6 Block Diagram of Test Setup

AC Power Lines Conducted Emission:

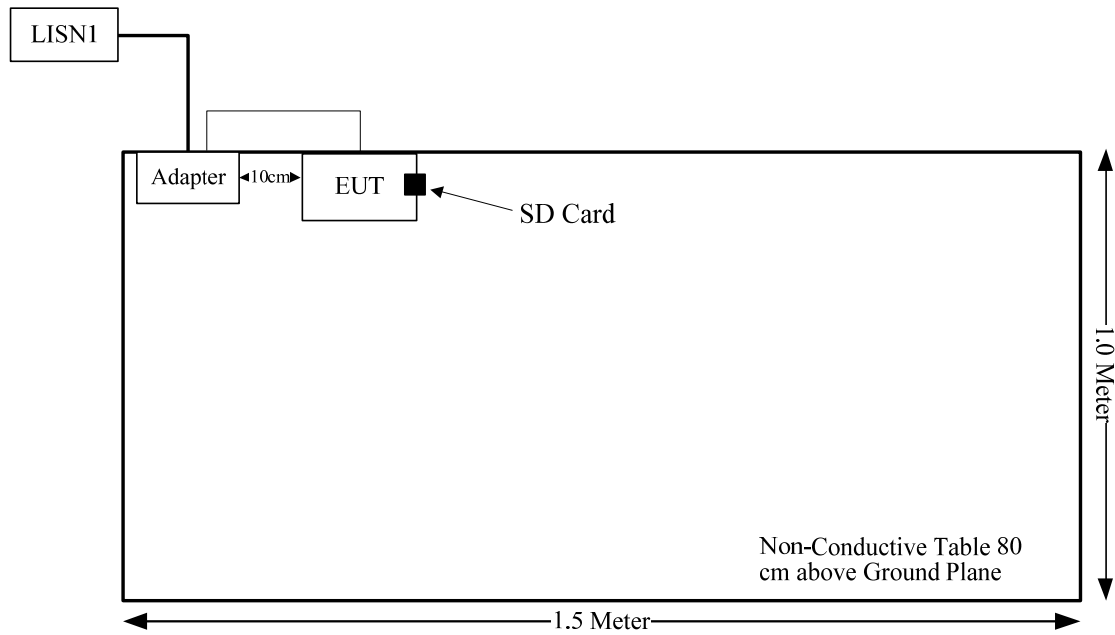

Radiated Spurious Emissions:
Below 1GHz:

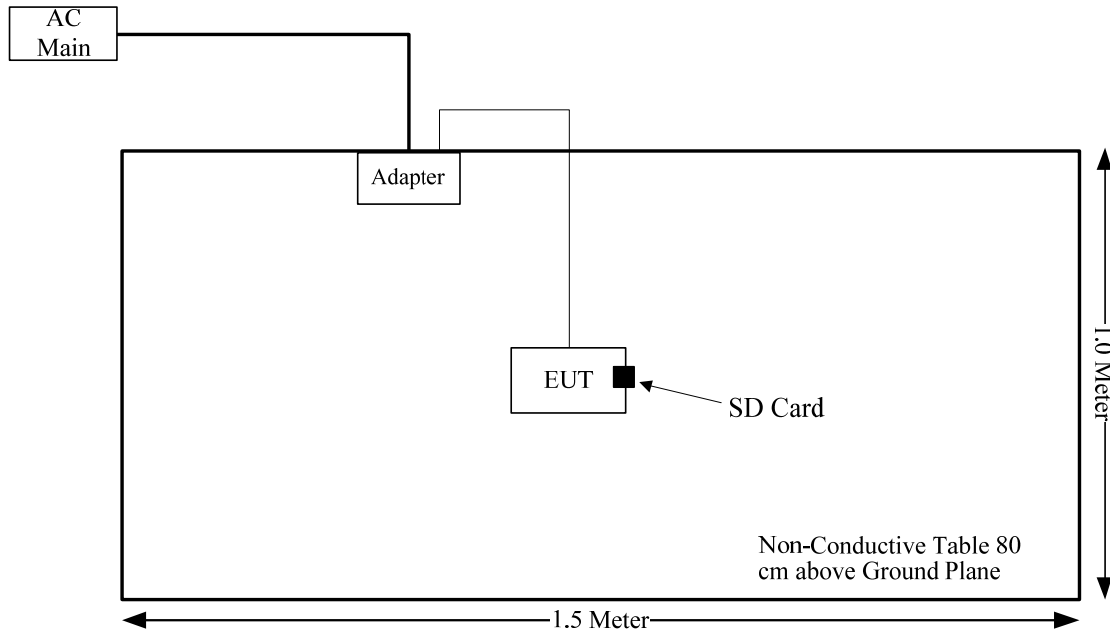

Above 1GHz:

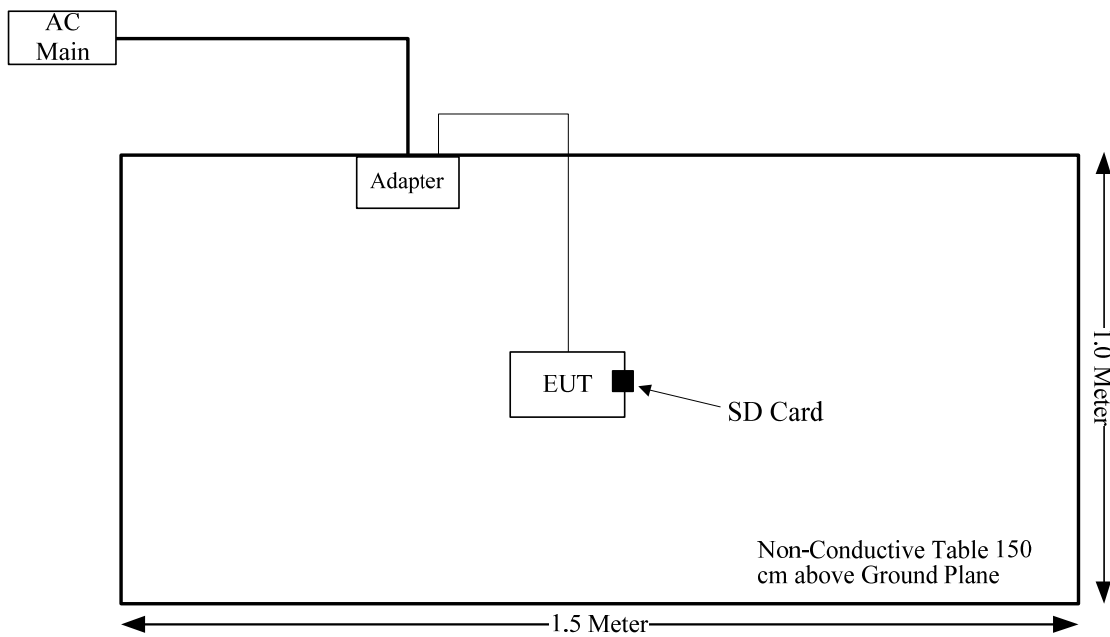

2.7 Test Facility

The Test site used by Bay Area Compliance Laboratories Corp. (Dongguan) to collect test data is located on the No.12, Pulong East 1st Road, Tangxia Town, Dongguan, Guangdong, China.

The lab has been recognized as the FCC accredited lab under the KDB 974614 D01 and is listed in the FCC Public Access Link (PAL) database, FCC Registration No. : 829273, the FCC Designation No. : CN5044.

2.8 Measurement Uncertainty

Otherwise required by the applicant or Product Regulations, Decision Rule in this report did not consider the uncertainty. The extended uncertainty given in this report is obtained by combining the standard uncertainty times the coverage factor K with the 95% confidence interval.

Parameter	Measurement Uncertainty
Occupied Channel Bandwidth	±5 %
RF output power, conducted	±0.61dB
Power Spectral Density, conducted	±0.61 dB
Unwanted Emissions, radiated	9kHz~30MHz: 3.3dB, 30MHz~200MHz: 4.55 dB, 200MHz~1GHz: 5.92 dB, 1GHz~6GHz: 4.98 dB, 6GHz~18GHz: 5.89 dB, 18GHz~26.5GHz:5.47 dB, 26.5GHz~40GHz:5.63 dB
Unwanted Emissions, conducted	±2.47 dB
Temperature	±1°C
Humidity	±5%
DC and low frequency voltages	±0.4%
Duty Cycle	1%
AC Power Lines Conducted Emission	3.11 dB (150 kHz to 30 MHz)

3. SUMMARY OF TEST RESULTS

Standard(s) Section	Test Items	Result
§15.207(a)	AC Line Conducted Emissions	Compliant
§15.205, §15.209, §15.247(d)	Spurious Emissions	Compliant
§15.247 (a)(2)	Minimum 6 dB Bandwidth	Compliant
§15.247(b)(3)	Maximum Conducted Output Power	Compliant
§15.247(d)	100 kHz Bandwidth Of Frequency Band Edge	Compliant
§15.247(e)	Power Spectral Density	Compliant
§15.203	Antenna Requirement	Compliant
§15.247 (i) & §1.1310 & §2.1091	RF Exposure Evaluation	Compliant

4. REQUIREMENTS AND TEST PROCEDURES

4.1 AC Line Conducted Emissions

4.1.1 Applicable Standard

FCC§15.207(a).

(a) Except as shown in paragraphs (b) and (c) of this section, for an intentional radiator that is designed to be connected to the public utility (AC) power line, the radio frequency voltage that is conducted back onto the AC power line on any frequency or frequencies, within the band 150 kHz to 30 MHz, shall not exceed the limits in the following table, as measured using a 50 μ H/50 ohms line impedance stabilization network (LISN). Compliance with the provisions of this paragraph shall be based on the measurement of the radio frequency voltage between each power line and ground at the power terminal. The lower limit applies at the boundary between the frequency ranges.

Frequency of emission (MHz)	Conducted limit (dB μ V)	
	Quasi-peak	Average
0.15-0.5	66 to 56*	56 to 46*
0.5-5	56	46
5-30	60	50

*Decreases with the logarithm of the frequency.

(b) The limit shown in paragraph (a) of this section shall not apply to carrier current systems operating as intentional radiators on frequencies below 30 MHz. In lieu thereof, these carrier current systems shall be subject to the following standards:

(1) For carrier current system containing their fundamental emission within the frequency band 535-1705 kHz and intended to be received using a standard AM broadcast receiver: no limit on conducted emissions.

(2) For all other carrier current systems: 1000 μ V within the frequency band 535-1705 kHz, as measured using a 50 μ H/50 ohms LISN.

(3) Carrier current systems operating below 30 MHz are also subject to the radiated emission limits in §15.205, §15.209, §15.221, §15.223, or §15.227, as appropriate.

(c) Measurements to demonstrate compliance with the conducted limits are not required for devices which only employ battery power for operation and which do not operate from the AC power lines or contain provisions for operation while connected to the AC power lines. Devices that include, or make provisions for, the use of battery chargers which permit operating while charging, AC adapters or battery eliminators or that connect to the AC power lines indirectly, obtaining their power through another device which is connected to the AC power lines, shall be tested to demonstrate compliance with the conducted limits.

4.1.2 EUT Setup

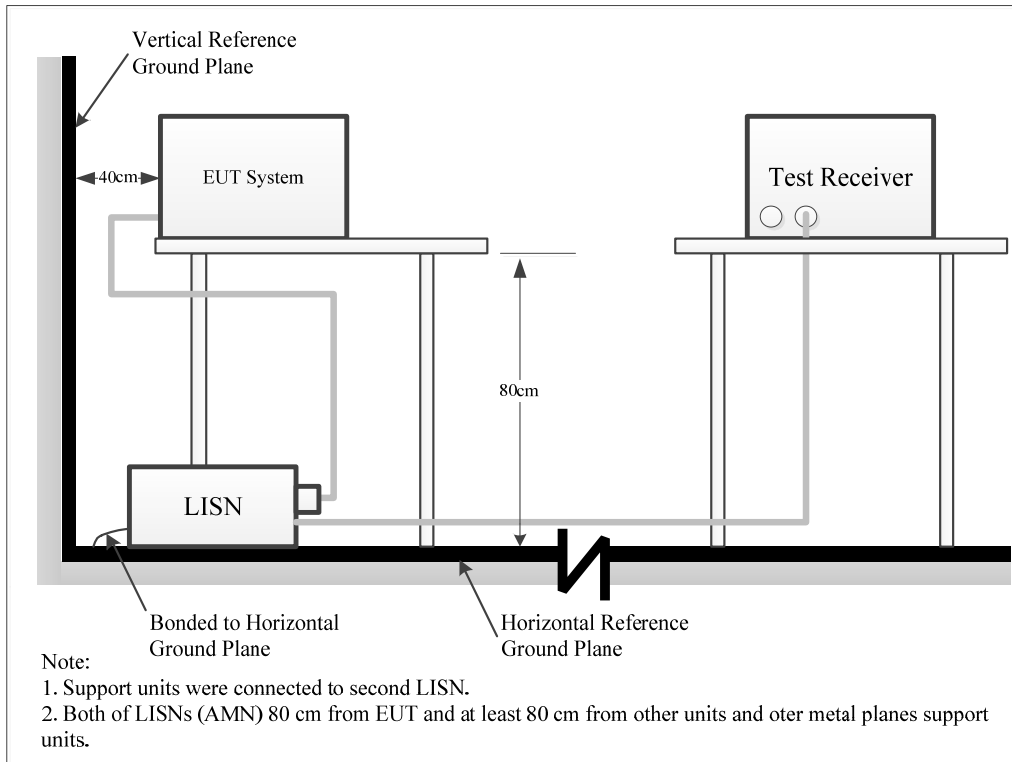

The setup of EUT is according with per ANSI C63.10-2013 measurement procedure. The specification used was with the FCC Part 15.207 limits.

The spacing between the peripherals was 10 cm.

The adapter or EUT was connected to the main LISN with a 120 V/60 Hz AC power source.

4.1.3 EMI Test Receiver Setup

The EMI test receiver was set to investigate the spectrum from 150 kHz to 30 MHz.

During the conducted emission test, the EMI test receiver was set with the following configurations:

Frequency Range	IF B/W
150 kHz – 30 MHz	9 kHz

4.1.4 Test Procedure

The frequency and amplitude of the six highest ac power-line conducted emissions relative to the limit, measured over all the current-carrying conductors of the EUT power cords, and the operating frequency or frequency to which the EUT is tuned (if appropriate), should be reported, unless such emissions are more than 20 dB below the limit. AC power-line conducted emissions measurements are to be separately carried out only on each of the phase (“hot”) line(s) and (if used) on the neutral line(s), but not on the ground [protective earth] line(s). If less than six emission frequencies are within 20 dB of the limit, then the noise level of the measuring instrument at representative frequencies should be reported. The specific conductor of the power-line cord for each of the reported emissions should be identified. Measure the six highest emissions with respect to the limit on each current-carrying conductor of each power cord associated with the EUT (but not the power cords of associated or peripheral equipment that are part of the test configuration). Then, report the six highest emissions with respect to the limit from among all the measurements identifying the frequency and specific current-carrying conductor identified with the emission. The six highest emissions should be reported for each of the current-carrying conductors, or the six highest emissions may be reported over all the current-carrying conductors.

4.1.5 Corrected Amplitude & Margin Calculation

The basic equation is as follows:

$$\text{Result} = \text{Reading} + \text{Factor}$$

$$\text{Factor} = \text{attenuation caused by cable loss} + \text{voltage division factor of AMN}$$

The “**Margin**” column of the following data tables indicates the degree of compliance within the applicable limit. The equation for margin calculation is as follows:

$$\text{Margin} = \text{Limit} - \text{Result}$$

4.1.6 Test Result

Please refer to section 5.1.

4.2 Radiation Spurious Emissions

4.2.1 Applicable Standard

FCC §15.247 (d);

In any 100 kHz bandwidth outside the frequency band in which the spread spectrum or digitally modulated intentional radiator is operating, the radio frequency power that is produced by the intentional radiator shall be at least 20 dB below that in the 100 kHz bandwidth within the band that contains the highest level of the desired power, based on either an RF conducted or a radiated measurement, provided the transmitter demonstrates compliance with the peak conducted power limits. If the transmitter complies with the conducted power limits based on the use of RMS averaging over a time interval, as permitted under paragraph (b)(3) of this section, the attenuation required under this paragraph shall be 30 dB instead of 20 dB. Attenuation below the general limits specified in §15.209(a) is not required. In addition, radiated emissions which fall in the restricted bands, as defined in §15.205(a), must also comply with the radiated emission limits specified in §15.209(a) (see §15.205(c)).

4.2.2 EUT Setup

9kHz~30MHz:

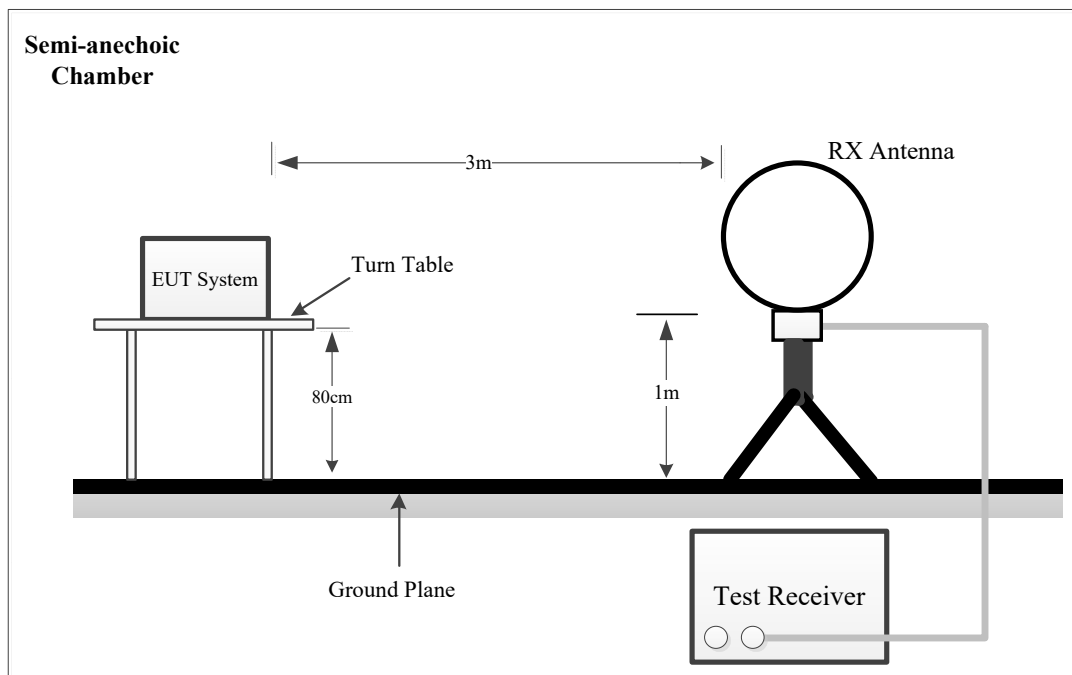

30MHz~1GHz:

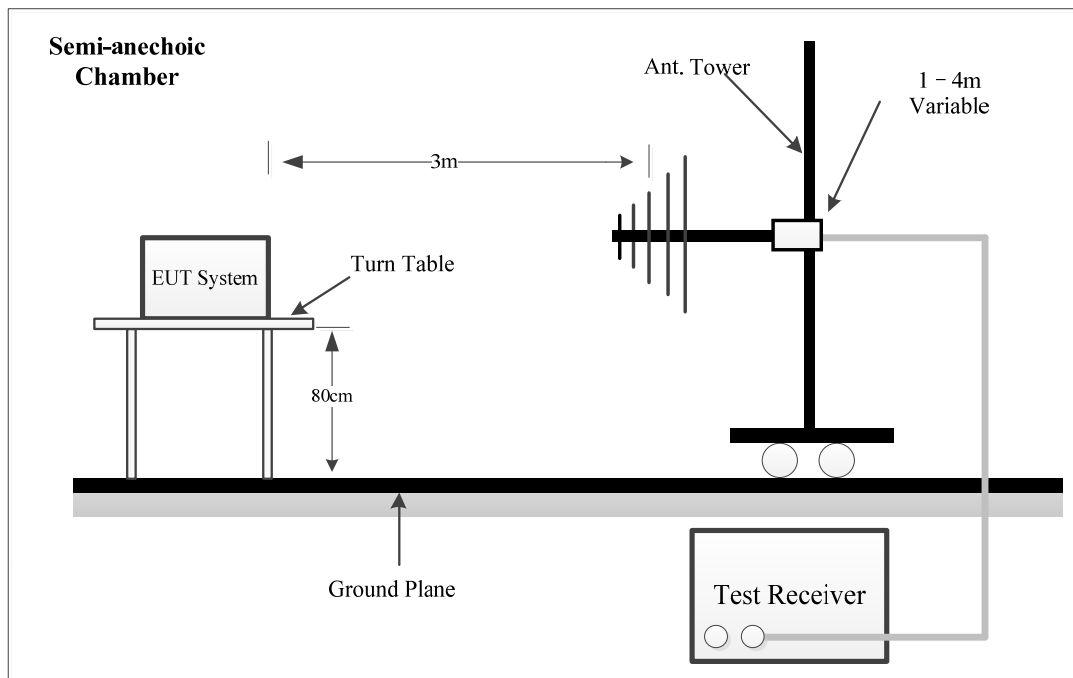

Above 1GHz:

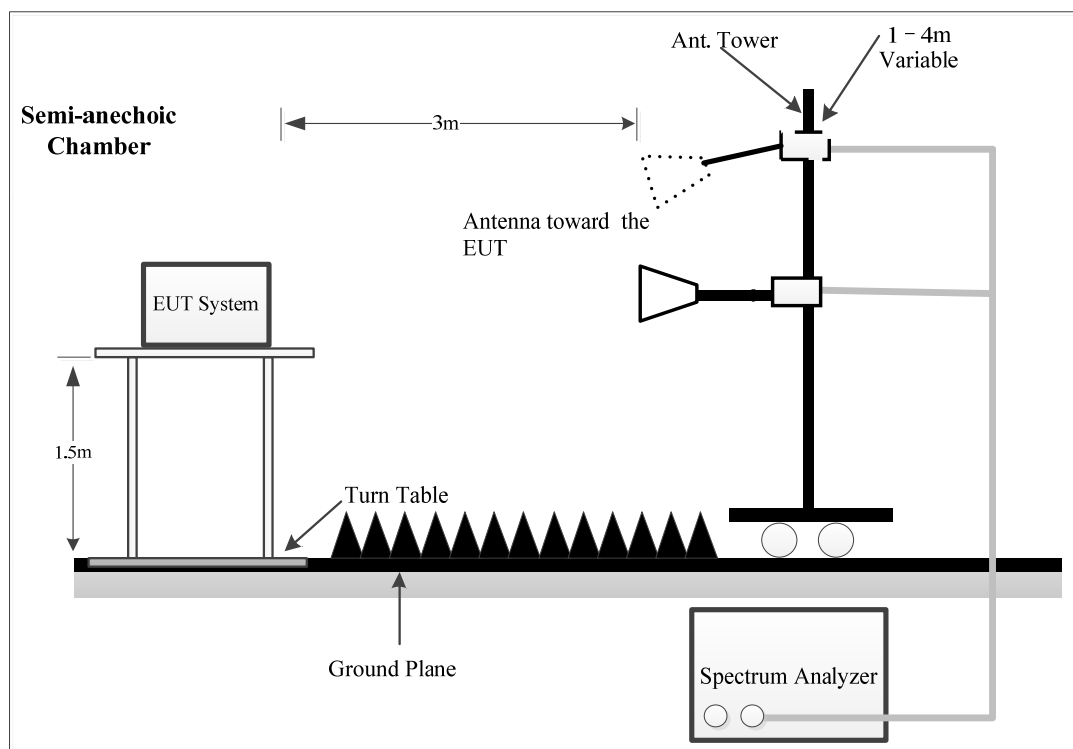

The radiated emissions were performed in the 3 meters distance, using the setup accordance with the ANSI C63.10-2013. The specification used was the FCC 15.209, and FCC 15.247 limits.

The external I/O cables were draped along the test table and formed a bundle 30 to 40 cm long in the middle.

The spacing between the peripherals was 10 cm.

For 9kHz-30MHz test, the lowest height of the magnetic antenna shall be 1 m above the ground and three antenna orientations (parallel, perpendicular, and ground-parallel) shall be measured.

4.2.3 EMI Test Receiver & Spectrum Analyzer Setup

The system was investigated from 9 kHz to 25 GHz.

During the radiated emission test, the EMI test receiver & Spectrum Analyzer Setup were set with the following configurations:

9kHz-1000MHz:

Frequency Range	Measurement	RBW	Video B/W	IF B/W
9 kHz – 150 kHz	QP/AV	200 Hz	1 kHz	200 Hz
150 kHz – 30 MHz	QP/AV	9 kHz	30 kHz	9 kHz
30 MHz – 1000 MHz	PK	100 kHz	300 kHz	/
	QP	/	/	120 kHz

1GHz- 25GHz:

Measurement	Duty cycle	RBW	Video B/W
PK	Any	1MHz	3 MHz
Ave.	>98%	1MHz	10 Hz
	<98%	1MHz	$\geq 1/T$

Note: T is minimum transmission duration

If the maximized peak measured value is under the QP/Average limit by more than 6dB, then it is unnecessary to perform an QP/Average measurement.

4.2.4 Test Procedure

Maximizing procedure was performed on the highest emissions to ensure that the EUT complied with all installation combinations.

Data was recorded in Quasi-peak detection mode for frequency range of 9 kHz -1 GHz, except 9-90 kHz, 110-490 kHz, employing an average detector, peak and Average detection modes for frequencies above 1 GHz.

4.2.5 Corrected Result & Margin Calculation

The basic equation is as follows:

Result = Reading + Factor

Factor = Antenna Factor + Cable Loss- Amplifier Gain

The “**Margin**” column of the following data tables indicates the degree of compliance within the applicable limit. The equation for margin calculation is as follows:

Margin = Limit – Result

4.2.6 Test Result

Please refer to section 5.2.

4.3 Minimum 6 dB Emission Bandwidth

4.3.1 Applicable Standard

FCC §15.247 (a)(2)

Systems using digital modulation techniques may operate in the 902-928 MHz, 2400-2483.5 MHz, and 5725-5850 MHz bands. The minimum 6 dB bandwidth shall be at least 500 kHz.

4.3.2 EUT Setup

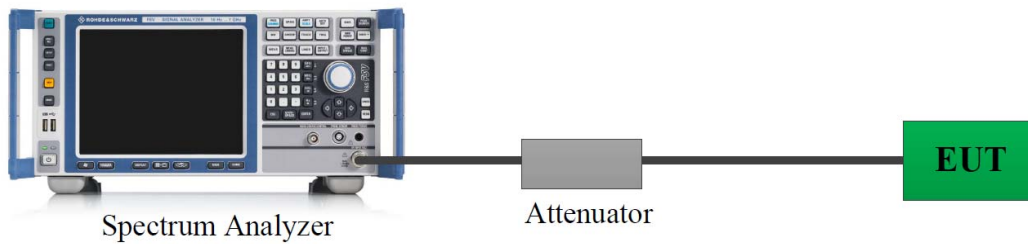

4.3.3 Test Procedure

According to ANSI C63.10-2013 Section 11.8

- a) Set RBW = 100 kHz.
- b) Set the video bandwidth (VBW) $\geq 3 \times$ RBW.
- c) Detector = Peak.
- d) Trace mode = max hold.
- e) Sweep = auto couple.
- f) Allow the trace to stabilize.
- g) Measure the maximum width of the emission that is constrained by the frequencies associated with the two outermost amplitude points (upper and lower frequencies) that are attenuated by 6 dB relative to the maximum level measured in the fundamental emission.

4.3.4 Test Result

Please refer to section 5.3.

4.4 99% Occupied Bandwidth

4.4.1 EUT Setup

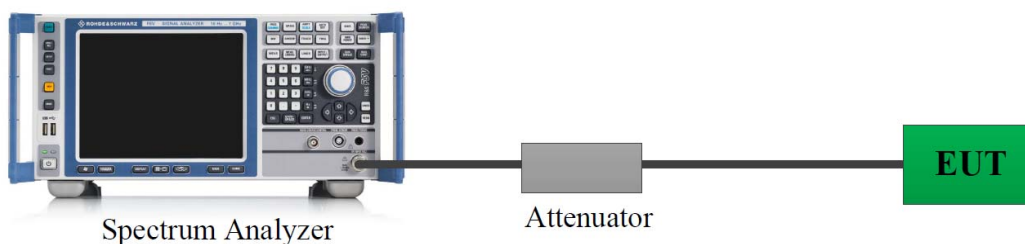

4.4.2 Test Procedure

According to ANSI C63.10-2013 Section 6.9.3

The occupied bandwidth is the frequency bandwidth such that, below its lower and above its upper frequency limits, the mean powers are each equal to 0.5% of the total mean power of the given emission. The following procedure shall be used for measuring 99% power bandwidth:

- a) The instrument center frequency is set to the nominal EUT channel center frequency. The frequency span for the spectrum analyzer shall be between 1.5 times and 5.0 times the OBW.
- b) The nominal IF filter bandwidth (3 dB RBW) shall be in the range of 1% to 5% of the OBW, and VBW shall be approximately three times the RBW, unless otherwise specified by the applicable requirement.
- c) Set the reference level of the instrument as required, keeping the signal from exceeding the maximum input mixer level for linear operation. In general, the peak of the spectral envelope shall be more than $[10 \log (OBW/RBW)]$ below the reference level. Specific guidance is given in 4.1.5.2.
- d) Step a) through step c) might require iteration to adjust within the specified range.
- e) Video averaging is not permitted. Where practical, a sample detection and single sweep mode shall be used. Otherwise, peak detection and max hold mode (until the trace stabilizes) shall be used.
- f) Use the 99% power bandwidth function of the instrument (if available) and report the measured bandwidth.
- g) If the instrument does not have a 99% power bandwidth function, then the trace data points are recovered and directly summed in linear power terms. The recovered amplitude data points, beginning at the lowest frequency, are placed in a running sum until 0.5% of the total is reached; that frequency is recorded as the lower frequency. The process is repeated until 99.5% of the total is reached; that frequency is recorded as the upper frequency. The 99% power bandwidth is the difference between these two frequencies.
- h) The occupied bandwidth shall be reported by providing plot(s) of the measuring instrument display; the plot axes and the scale units per division shall be clearly labeled. Tabular data may be reported in addition to the plot(s).

4.4.3 Test Result

Please refer to section 5.4.

4.5 Maximum Conducted Output Power

4.5.1 Applicable Standard

FCC §15.247 (b)(3)

For systems using digital modulation in the 902-928 MHz, 2400-2483.5 MHz, and 5725-5850 MHz bands: 1 Watt. As an alternative to a peak power measurement, compliance with the one Watt limit can be based on a measurement of the maximum conducted output power. Maximum Conducted Output Power is defined as the total transmit power delivered to all antennas and antenna elements averaged across all symbols in the signaling alphabet when the transmitter is operating at its maximum power control level. Power must be summed across all antennas and antenna elements. The average must not include any time intervals during which the transmitter is off or is transmitting at a reduced power level. If multiple modes of operation are possible (e.g., alternative modulation methods), the maximum conducted output power is the highest total transmit power occurring in any mode.

4.5.2 EUT Setup

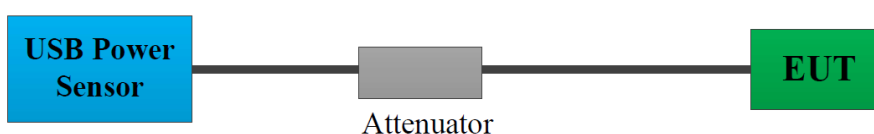

4.5.3 Test Procedure

According to ANSI C63.10-2013 Section 11.9.1.3

The maximum peak conducted output power may be measured using a broadband peak RF power meter. The power meter shall have a video bandwidth that is greater than or equal to the DTS bandwidth and shall use a fast-responding diode detector.

- a) Set the EUT in transmitting mode.
- b) Remove the antenna from the EUT and then connect a low loss RF cable from the antenna port to test equipment.
- c) Add a correction factor to the display.
- d) Set the power meter to test peak output power, record the result.

According to ANSI C63.10-2013 Section 11.9.2.3.2

Method AVGPM-G is a measurement using a gated RF average power meter.

Alternatively, measurements may be performed using a wideband gated RF power meter provided that the gate parameters are adjusted such that the power is measured only when the EUT is transmitting at its maximum power control level. Because the measurement is made only during the ON time of the transmitter, no duty cycle correction factor is required.

4.5.4 Test Result

Please refer to section 5.5.

4.6 Maximum Power Spectral Density

4.6.1 Applicable Standard

FCC §15.247 (e)

For digitally modulated systems, the power spectral density conducted from the intentional radiator to the antenna shall not be greater than 8 dBm in any 3 kHz band during any time interval of continuous transmission. This power spectral density shall be determined in accordance with the provisions of paragraph (b) of this section. The same method of determining the conducted output power shall be used to determine the power spectral density.

4.6.2 EUT Setup

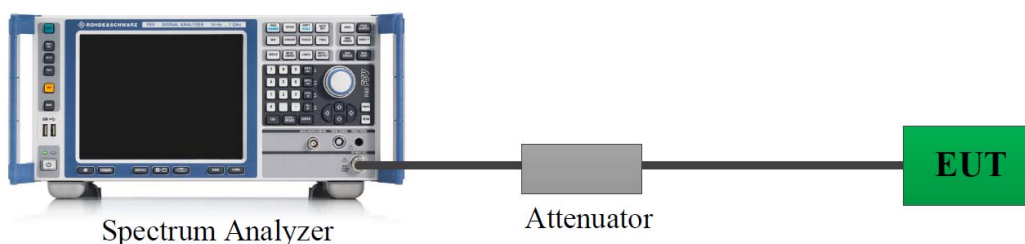

4.6.3 Test Procedure

According to ANSI C63.10-2013 Section 11.10.2

The following procedure shall be used if maximum peak conducted output power was used to determine compliance:

- a) Set analyzer center frequency to DTS channel center frequency.
- b) Set the span to 1.5 times the DTS bandwidth.
- c) Set RBW to: $3 \text{ kHz} \leq \text{RBW} \leq 100 \text{ kHz}$.
- d) Set VBW $\geq [3 \times \text{RBW}]$.
- e) Detector = peak.
- f) Sweep time = auto couple.
- g) Trace mode = max hold.
- h) Allow trace to fully stabilize.
- i) Use the peak marker function to determine the maximum amplitude level within the RBW.
- j) If measured value exceeds requirement, then reduce RBW (but no less than 3 kHz) and repeat.

4.6.4 Test Result

Please refer to section 5.6.

4.7 100 kHz Bandwidth of Frequency Band Edge

4.7.1 Applicable Standard

FCC §15.247 (d);

In any 100 kHz bandwidth outside the frequency band in which the spread spectrum or digitally modulated intentional radiator is operating, the radio frequency power that is produced by the intentional radiator shall be at least 20 dB below that in the 100 kHz bandwidth within the band that contains the highest level of the desired power, based on either an RF conducted or a radiated measurement, provided the transmitter demonstrates compliance with the peak conducted power limits. If the transmitter complies with the conducted power limits based on the use of RMS averaging over a time interval, as permitted under paragraph (b)(3) of this section, the attenuation required under this paragraph shall be 30 dB instead of 20 dB. Attenuation below the general limits specified in §15.209(a) is not required. In addition, radiated emissions which fall in the restricted bands, as defined in §15.205(a), must also comply with the radiated emission limits specified in §15.209(a) (see §15.205(c)).

4.7.2 EUT Setup

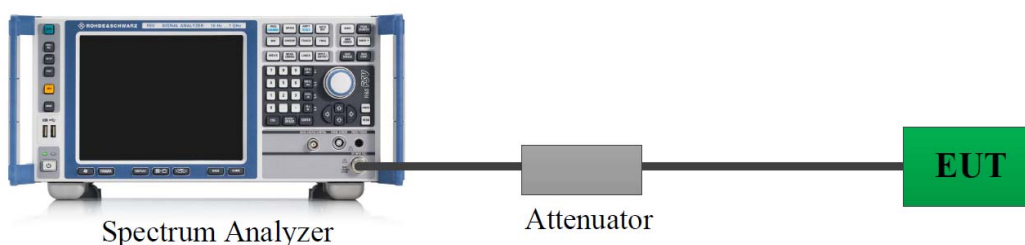

4.7.3 Test Procedure

According to ANSI C63.10-2013 Section 11.11

- Set the center frequency and span to encompass frequency range to be measured.
 - Set the RBW = 100 kHz.
 - Set the VBW $\geq [3 \times \text{RBW}]$.
 - Detector = peak.
 - Sweep time = auto couple.
 - Trace mode = max hold.
 - Allow trace to fully stabilize.
 - Use the peak marker function to determine the maximum amplitude level.
- Ensure that the amplitude of all unwanted emissions outside of the authorized frequency band (excluding restricted frequency bands) is attenuated by at least the minimum requirements specified in 11.11. Report the three highest emissions relative to the limit.

4.7.4 Test Result

Please refer to section 5.7.

4.8 Duty Cycle

4.8.1 EUT Setup

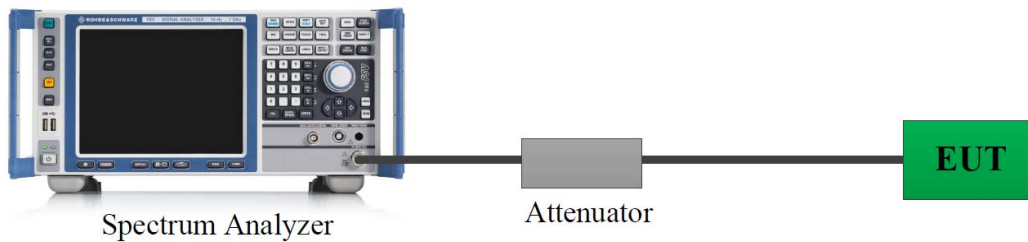

4.8.2 Test Procedure

According to ANSI C63.10-2013 Section 11.6

The zero-span mode on a spectrum analyzer or EMI receiver if the response time and spacing between bins on the sweep are sufficient to permit accurate measurements of the ON and OFF times of the transmitted signal:

- 1) Set the center frequency of the instrument to the center frequency of the transmission.
- 2) Set $RBW \geq OBW$ if possible; otherwise, set RBW to the largest available value.
- 3) Set $VBW \geq RBW$. Set detector = peak or average.
- 4) The zero-span measurement method shall not be used unless both RBW and VBW are $> 50/T$ and the number of sweep points across duration T exceeds 100. (For example, if VBW and/or RBW are limited to 3 MHz, then the zero-span method of measuring the duty cycle shall not be used if $T \leq 16.7 \mu s$.)

4.8.3 Judgment

Report Only.

4.9 Antenna Requirement

4.9.1 Applicable Standard

FCC §15.203

An intentional radiator shall be designed to ensure that no antenna other than that furnished by the responsible party shall be used with the device. The use of a permanently attached antenna or of an antenna that uses a unique coupling to the intentional radiator shall be considered sufficient to comply with the provisions of this section. The manufacturer may design the unit so that a broken antenna can be replaced by the user, but the use of a standard antenna jack or electrical connector is prohibited. This requirement does not apply to carrier current devices or to devices operated under the provisions of §§15.211, 15.213, 15.217, 15.219, 15.221, or §15.236. Further, this requirement does not apply to intentional radiators that must be professionally installed, such as perimeter protection systems and some field disturbance sensors, or to other intentional radiators which, in accordance with §15.31(d), must be measured at the installation site. However, the installer shall be responsible for ensuring that the proper antenna is employed so that the limits in this part are not exceeded.

4.9.2 Judgment

Compliant. Please refer to the Antenna Information detail in Section 1.

5. Test DATA AND RESULTS

5.1 AC Line Conducted Emissions

Serial Number:	2F7I-7	Test Date:	2023/12/28
Test Site:	CE	Test Mode:	Transmitting
Tester:	Lane Sun	Test Result:	Pass

Environmental Conditions:

Temperature: (°C)	19.4	Relative Humidity: (%)	53	ATM Pressure: (kPa)	101.6
----------------------	------	------------------------------	----	------------------------	-------

Test Equipment List and Details:

Manufacturer	Description	Model	Serial Number	Calibration Date	Calibration Due Date
R&S	LISN	ENV216	101614	2023/10/18	2024/10/17
MICRO-COAX	Coaxial Cable	C-NJNJ-50	C-0200-01	2023/9/5	2024/9/4
R&S	EMI Test Receiver	ESCI	100035	2023/8/18	2024/8/17
R&S	Test Software	EMC32	V9.10.00	N/A	N/A

* Statement of Traceability: Bay Area Compliance Laboratories Corp. (Dongguan) attests that all calibrations have been performed, traceable to National Primary Standards and International System of Units (SI).

Project No: DG2231214-75516E-RF
 Test Engineer: Lane Sun
 Test Date: 2023-12-28
 Port: L
 Test Mode: Transmitting(802.11g 2412MHz was tested)
 Power Source: AC 120V/60Hz

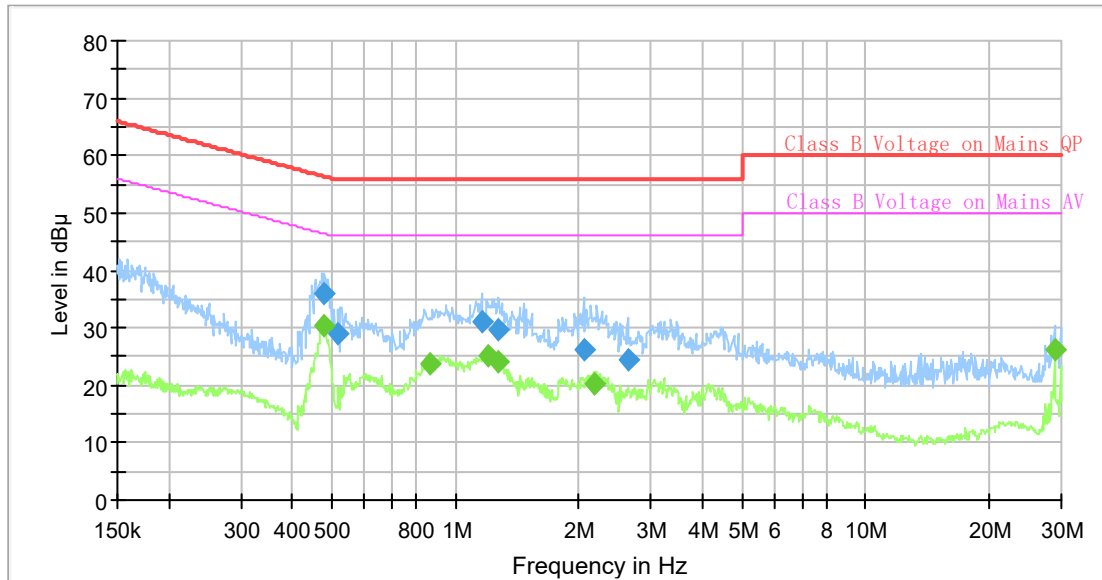

Final Result

Frequency (MHz)	QuasiPeak (dB μ V)	Average (dB μ V)	Limit (dB μ V)	Margin (dB)	Bandwidth (kHz)	Line	Corr. (dB)
0.479495	35.91	---	56.35	20.44	9.000	L1	10.8
0.479495	---	30.32	46.35	16.03	9.000	L1	10.8
0.516743	29.01	---	56.00	26.99	9.000	L1	10.8
0.868051	---	23.93	46.00	22.07	9.000	L1	10.9
1.159249	31.16	---	56.00	24.84	9.000	L1	10.8
1.206438	---	25.31	46.00	20.69	9.000	L1	10.8
1.268136	---	24.09	46.00	21.91	9.000	L1	10.8
1.274476	29.63	---	56.00	26.37	9.000	L1	10.8
2.057187	26.25	---	56.00	29.75	9.000	L1	10.8
2.173203	---	20.40	46.00	25.60	9.000	L1	10.8
2.639835	24.35	---	56.00	31.65	9.000	L1	10.8
28.925869	---	26.10	50.00	23.90	9.000	L1	10.9

Project No: DG2231214-75516E-RF
 Test Engineer: Lane Sun
 Test Date: 2023-12-28
 Port: N
 Test Mode: Transmitting(802.11g 2412MHz was tested)
 Power Source: AC 120V/60Hz

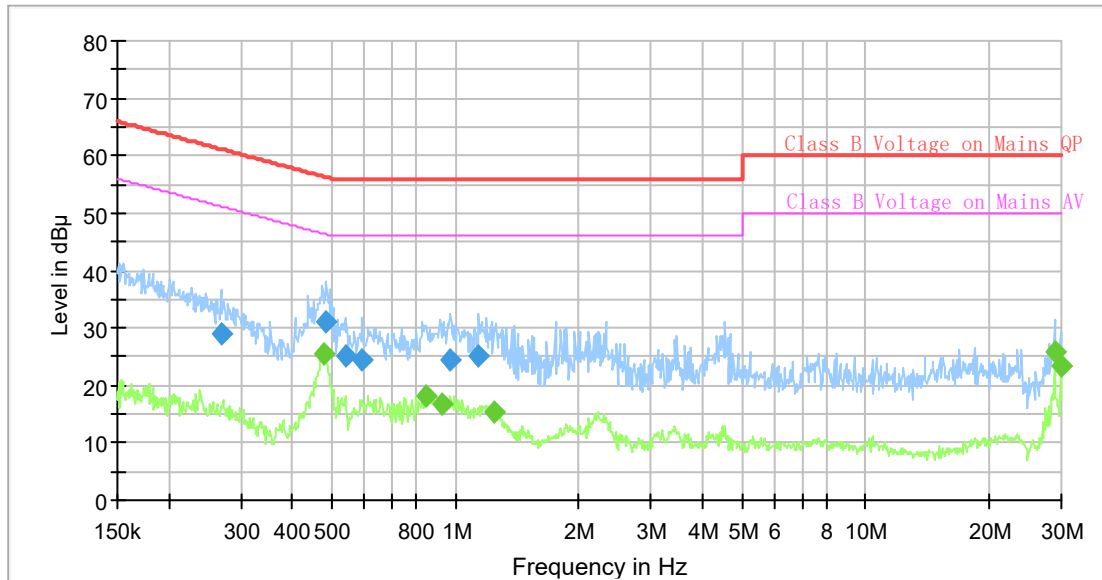

Final Result

Frequency (MHz)	QuasiPeak (dB μ V)	Average (dB μ V)	Limit (dB μ V)	Margin (dB)	Bandwidth (kHz)	Line	Corr. (dB)
0.268856	29.15	---	61.15	32.00	9.000	N	10.8
0.477109	---	25.39	46.39	21.00	9.000	N	10.7
0.484301	31.13	---	56.26	25.13	9.000	N	10.7
0.537778	25.14	---	56.00	30.86	9.000	N	10.7
0.594189	24.45	---	56.00	31.55	9.000	N	10.7
0.850904	---	18.12	46.00	27.88	9.000	N	10.8
0.930829	---	16.85	46.00	29.15	9.000	N	10.8
0.973564	24.49	---	56.00	31.51	9.000	N	10.8
1.142032	25.13	---	56.00	30.87	9.000	N	10.9
1.249302	---	15.32	46.00	30.68	9.000	N	10.9
28.925869	---	25.71	50.00	24.29	9.000	N	11.0
29.953587	---	23.37	50.00	26.63	9.000	N	11.0

5.2 Radiation Spurious Emissions

Serial Number:	2F7I-7 2F7I-10	Test Date:	Below 1GHz: 2023/12/28~2024/1/12 Above 1GHz: 2024/1/5
Test Site:	Chamber 10m, Chamber B	Test Mode:	Transmitting
Tester:	Zoo Zou, Colin Yang, Leo Xiao	Test Result:	Pass

Environmental Conditions:					
Temperature: (°C)	20.3~22.9	Relative Humidity: (%)	45~46	ATM Pressure: (kPa)	101.3~101.5

Test Equipment List and Details:

Manufacturer	Description	Model	Serial Number	Calibration Date	Calibration Due Date
9kHz~1000MHz					
Sunol Sciences	Hybrid Antenna	JB3	A060611-1	2023/9/6	2024/9/5
EMCO	Passive Loop Antenna	6512	9706-1206	2021/3/5	2024/3/5
Narda	Attenuator	779-6dB	04269	2023/9/6	2024/9/5
Unknown	Coaxial Cable	C-NJNJ-50	C-1000-01	2023/8/1	2024/7/31
Unknown	Coaxial Cable	C-NJNJ-50	C-0400-04	2023/8/1	2024/7/31
Unknown	Coaxial Cable	C-NJNJ-50	C-0530-01	2023/8/1	2024/7/31
Sonoma	Amplifier	310N	185914	2023/8/1	2024/7/31
R&S	EMI Test Receiver	ESCI	100224	2023/8/18	2024/8/17
Farad	Test Software	EZ-EMC	V1.1.4.2	N/A	N/A
Above 1GHz					
ETS-Lindgren	Horn Antenna	3115	000 527 35	2023/9/7	2024/9/6
Ducommun Technologies	Horn Antenna	ARH-4223-02	1007726-02 1304	2023/2/22	2026/2/21
Xinhang Macrowave	Coaxial Cable	XH750A-N/J-SMA/J-10M	20231117004 #0001	2023/11/17	2024/11/16
Xinhang Macrowave	Coaxial Cable	XH360A-2.92/J-2.92/J-6M-A	20231208001 #0001	2023/12/11	2024/12/10
AH	Preamplifier	PAM-0118P	469	2023/8/19	2024/8/18
AH	Preamplifier	PAM-1840VH	191	2023/9/7	2024/9/6
R&S	Spectrum Analyzer	FSV40	101944	2023/10/18	2024/10/17
E-Microwave	Band Rejection Filter	OBSF-2400-2483.5-S	OE01601525	2023/6/16	2024/6/15
Audix	Test Software	E3	191218 (V9)	N/A	N/A

* Statement of Traceability: Bay Area Compliance Laboratories Corp. (Dongguan) attests that all calibrations have been performed, traceable to National Primary Standards and International System of Units (SI).

Test Data:

Please refer to the below table and plots.
After pre-scan in the X, Y and Z axes of orientation, the worst case is below:

1) 9kHz~30MHz

The amplitude of spurious emissions attenuated more than 20 dB below the permissible value is not required to be report.

1) 30MHz-1GHz

Project No: DG2231214-75516E-RF
 Test Engineer: Zoo Zou
 Test Date: 2023-12-28
 Polarization: Horizontal
 Test Mode: Transmitting_802.11g Low channel(Maximum power mode)
 Power Source: AC 120V/60Hz
 Note: Model: T8W11C

80.0 dBuV/m

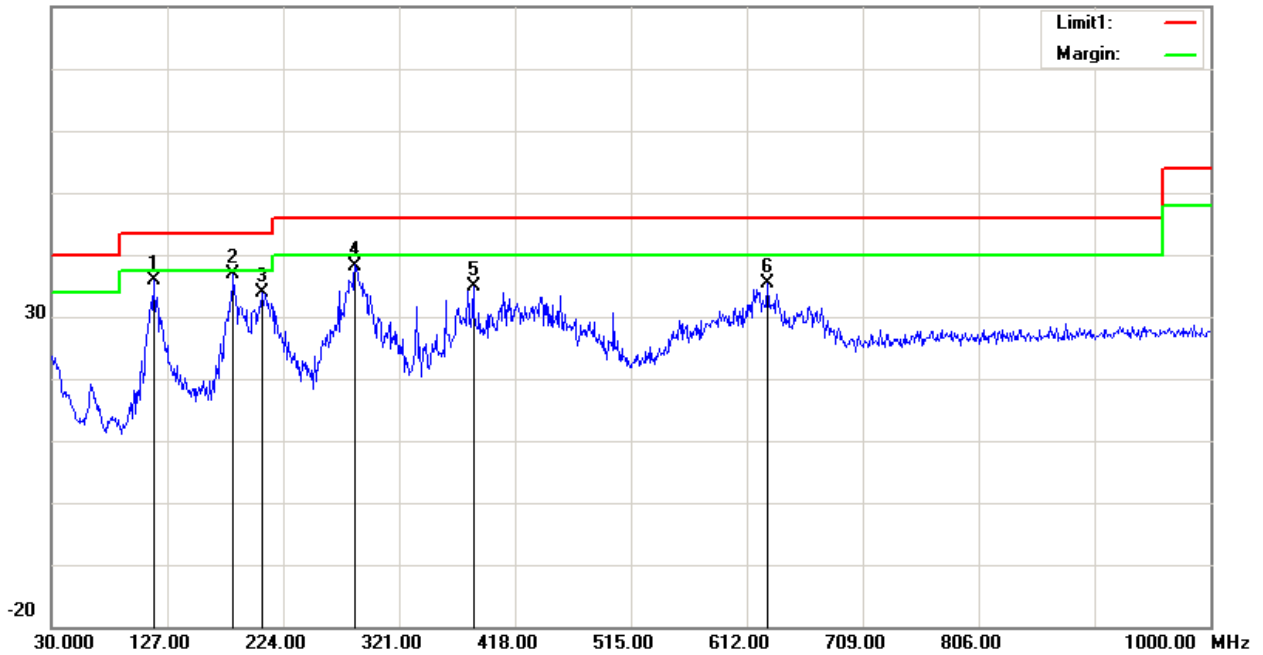

No.	Frequency (MHz)	Reading (dBuV)	Detector	Corrected (dB/m)	Result (dBuV/m)	Limit (dBuV/m)	Margin (dB)
1	115.3600	46.28	peak	-10.45	35.83	43.50	7.67
2	182.2900	49.12	peak	-12.26	36.86	43.50	6.64
3	206.5400	45.96	peak	-12.17	33.79	43.50	9.71
4	284.1400	47.88	peak	-9.63	38.25	46.00	7.75
5	383.0800	42.42	peak	-7.55	34.87	46.00	11.13
6	629.4600	37.51	peak	-2.18	35.33	46.00	10.67

Project No: DG2231214-75516E-RF
 Test Engineer: Zoo Zou
 Test Date: 2023-12-28
 Polarization: Vertical
 Test Mode: Transmitting_802.11g Low channel(Maximum power mode)
 Power Source: AC 120V/60Hz
 Note: Model: T8W11C

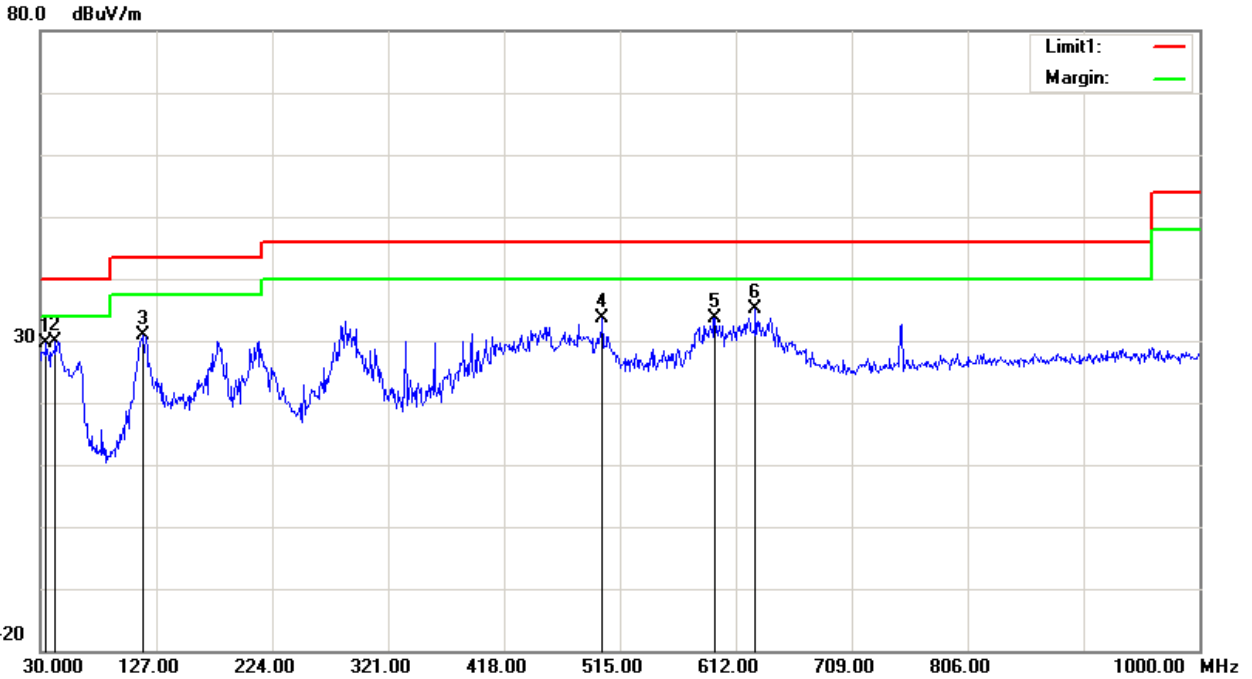

No.	Frequency (MHz)	Reading (dBuV)	Detector	Corrected (dB/m)	Result (dBuV/m)	Limit (dBuV/m)	Margin (dB)
1	34.8500	36.47	peak	-6.83	29.64	40.00	10.36
2	42.6100	42.67	peak	-12.70	29.97	40.00	10.03
3	116.3300	41.28	peak	-10.30	30.98	43.50	12.52
4	500.4500	37.83	peak	-4.28	33.55	46.00	12.45
5	594.5400	36.67	peak	-2.97	33.70	46.00	12.30
6	628.4900	37.41	peak	-2.19	35.22	46.00	10.78

Project No: DG2231214-75516E -RF
 Test Engineer: Zoo Zou
 Test Date: 2024-1-12
 Polarization: Horizontal
 Test Mode: Transmitting_802.11g Low channel(Maximum power mode)
 Power Source: AC 120V/60Hz
 Note: Model: T8419

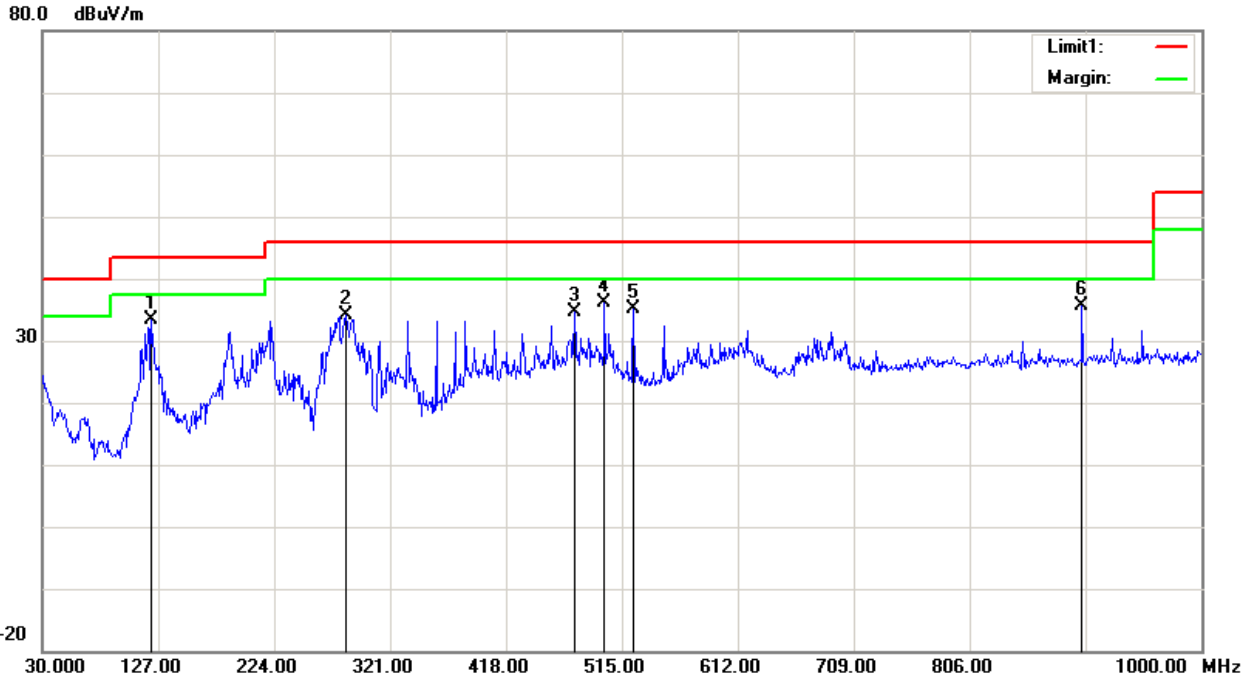

No.	Frequency (MHz)	Reading (dBuV)	Detector	Corrected (dB/m)	Result (dBuV/m)	Limit (dBuV/m)	Margin (dB)
1	121.1800	43.24	peak	-9.84	33.40	43.50	10.10
2	284.1400	43.82	peak	-9.63	34.19	46.00	11.81
3	475.2300	39.26	peak	-4.62	34.64	46.00	11.36
4	500.4500	40.49	peak	-4.28	36.21	46.00	9.79
5	524.7000	39.22	peak	-4.16	35.06	46.00	10.94
6	900.0900	34.29	peak	1.41	35.70	46.00	10.30

Project No: DG2231214-75516E -RF
 Test Engineer: Zoo Zou
 Test Date: 2024-1-12
 Polarization: Vertical
 Test Mode: Transmitting_802.11g Low channel(Maximum power mode)
 Power Source: AC 120V/60Hz
 Note: Model: T8419

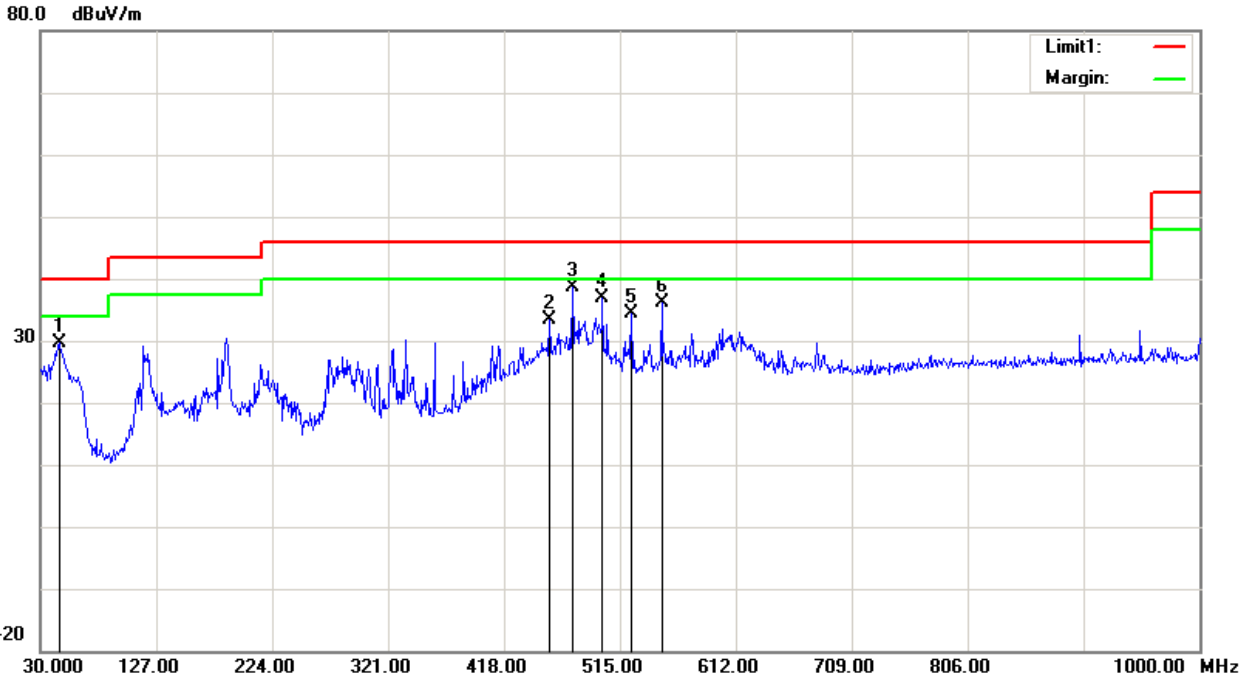

No.	Frequency (MHz)	Reading (dBuV)	Detector	Corrected (dB/m)	Result (dBuV/m)	Limit (dBuV/m)	Margin (dB)
1	45.5200	44.20	peak	-14.55	29.65	40.00	10.35
2	455.8300	38.63	peak	-5.22	33.41	46.00	12.59
3	475.2300	43.31	peak	-4.62	38.69	46.00	7.31
4	500.4500	41.21	peak	-4.28	36.93	46.00	9.07
5	524.7000	38.63	peak	-4.16	34.47	46.00	11.53
6	549.9200	39.58	peak	-3.43	36.15	46.00	9.85

Worst Test plots
3) 1-18GHz:

802.11b mode, Low Channel, Horizontal		802.11b mode, Low Channel, Vertical																																																																																																																	
Project No.: DG2231214-75516E-RF Polarization: Horizontal Test Mode: Transmitting Note: 802.11b_low channel Serial No.: 2F7I-7 Tester: Leo Xiao		Project No.: DG2231214-75516E-RF Polarization: Vertical Test Mode: Transmitting Note: 802.11b_low channel Serial No.: 2F7I-7 Tester: Leo Xiao																																																																																																																	
<table border="1"> <thead> <tr> <th>No.</th> <th>Frequency (MHz)</th> <th>Reading (dBuV)</th> <th>Factor (dB/m)</th> <th>Result (dBuV/m)</th> <th>Limit (dBuV/m)</th> <th>Margin (dB)</th> <th>Detector</th> </tr> </thead> <tbody> <tr> <td>1</td> <td>4824.00</td> <td>55.59</td> <td>-2.98</td> <td>52.61</td> <td>54.00</td> <td>1.39</td> <td>Average</td> </tr> <tr> <td>2</td> <td>4824.00</td> <td>58.13</td> <td>-2.98</td> <td>55.15</td> <td>74.00</td> <td>18.85</td> <td>Peak</td> </tr> </tbody> </table>		No.	Frequency (MHz)	Reading (dBuV)	Factor (dB/m)	Result (dBuV/m)	Limit (dBuV/m)	Margin (dB)	Detector	1	4824.00	55.59	-2.98	52.61	54.00	1.39	Average	2	4824.00	58.13	-2.98	55.15	74.00	18.85	Peak	<table border="1"> <thead> <tr> <th>No.</th> <th>Frequency (MHz)</th> <th>Reading (dBuV)</th> <th>Factor (dB/m)</th> <th>Result (dBuV/m)</th> <th>Limit (dBuV/m)</th> <th>Margin (dB)</th> <th>Detector</th> </tr> </thead> <tbody> <tr> <td>1</td> <td>4824.00</td> <td>55.89</td> <td>-2.98</td> <td>52.91</td> <td>54.00</td> <td>1.09</td> <td>Average</td> </tr> <tr> <td>2</td> <td>4824.00</td> <td>58.38</td> <td>-2.98</td> <td>55.40</td> <td>74.00</td> <td>18.60</td> <td>Peak</td> </tr> </tbody> </table>		No.	Frequency (MHz)	Reading (dBuV)	Factor (dB/m)	Result (dBuV/m)	Limit (dBuV/m)	Margin (dB)	Detector	1	4824.00	55.89	-2.98	52.91	54.00	1.09	Average	2	4824.00	58.38	-2.98	55.40	74.00	18.60	Peak																																																																
No.	Frequency (MHz)	Reading (dBuV)	Factor (dB/m)	Result (dBuV/m)	Limit (dBuV/m)	Margin (dB)	Detector																																																																																																												
1	4824.00	55.59	-2.98	52.61	54.00	1.39	Average																																																																																																												
2	4824.00	58.13	-2.98	55.15	74.00	18.85	Peak																																																																																																												
No.	Frequency (MHz)	Reading (dBuV)	Factor (dB/m)	Result (dBuV/m)	Limit (dBuV/m)	Margin (dB)	Detector																																																																																																												
1	4824.00	55.89	-2.98	52.91	54.00	1.09	Average																																																																																																												
2	4824.00	58.38	-2.98	55.40	74.00	18.60	Peak																																																																																																												
Project No.: DG2231214-75516E-RF Polarization: Horizontal Test Mode: Transmitting Note: 802.11b_low channel Serial No.: 2F7I-7 Tester: Colin Yang		Project No.: DG2231214-75516E-RF Polarization: Vertical Test Mode: Transmitting Note: 802.11b_low channel Serial No.: 2F7I-7 Tester: Colin Yang																																																																																																																	
<table border="1"> <thead> <tr> <th>No.</th> <th>Frequency (MHz)</th> <th>Reading (dBuV)</th> <th>Factor (dB/m)</th> <th>Result (dBuV/m)</th> <th>Limit (dBuV/m)</th> <th>Margin (dB)</th> <th>Detector</th> </tr> </thead> <tbody> <tr> <td>1</td> <td>7236.00</td> <td>36.85</td> <td>1.79</td> <td>38.64</td> <td>54.00</td> <td>15.36</td> <td>Average</td> </tr> <tr> <td>2</td> <td>7236.00</td> <td>45.48</td> <td>1.79</td> <td>47.27</td> <td>74.00</td> <td>26.73</td> <td>Peak</td> </tr> <tr> <td>3</td> <td>16943.79</td> <td>33.27</td> <td>11.57</td> <td>44.84</td> <td>54.00</td> <td>9.16</td> <td>Average</td> </tr> <tr> <td>4</td> <td>16943.79</td> <td>45.54</td> <td>11.57</td> <td>57.11</td> <td>74.00</td> <td>16.89</td> <td>Peak</td> </tr> <tr> <td>5</td> <td>18000.00</td> <td>28.96</td> <td>18.15</td> <td>47.11</td> <td>54.00</td> <td>6.89</td> <td>Average</td> </tr> <tr> <td>6</td> <td>18000.00</td> <td>39.85</td> <td>18.15</td> <td>58.00</td> <td>74.00</td> <td>16.00</td> <td>Peak</td> </tr> </tbody> </table>		No.	Frequency (MHz)	Reading (dBuV)	Factor (dB/m)	Result (dBuV/m)	Limit (dBuV/m)	Margin (dB)	Detector	1	7236.00	36.85	1.79	38.64	54.00	15.36	Average	2	7236.00	45.48	1.79	47.27	74.00	26.73	Peak	3	16943.79	33.27	11.57	44.84	54.00	9.16	Average	4	16943.79	45.54	11.57	57.11	74.00	16.89	Peak	5	18000.00	28.96	18.15	47.11	54.00	6.89	Average	6	18000.00	39.85	18.15	58.00	74.00	16.00	Peak	<table border="1"> <thead> <tr> <th>No.</th> <th>Frequency (MHz)</th> <th>Reading (dBuV)</th> <th>Factor (dB/m)</th> <th>Result (dBuV/m)</th> <th>Limit (dBuV/m)</th> <th>Margin (dB)</th> <th>Detector</th> </tr> </thead> <tbody> <tr> <td>1</td> <td>7236.00</td> <td>36.92</td> <td>1.79</td> <td>38.71</td> <td>54.00</td> <td>15.29</td> <td>Average</td> </tr> <tr> <td>2</td> <td>7236.00</td> <td>46.40</td> <td>1.79</td> <td>48.19</td> <td>74.00</td> <td>25.81</td> <td>Peak</td> </tr> <tr> <td>3</td> <td>17313.46</td> <td>32.01</td> <td>14.36</td> <td>46.37</td> <td>54.00</td> <td>7.63</td> <td>Average</td> </tr> <tr> <td>4</td> <td>17313.46</td> <td>43.22</td> <td>14.36</td> <td>57.58</td> <td>74.00</td> <td>16.42</td> <td>Peak</td> </tr> <tr> <td>5</td> <td>18000.00</td> <td>29.12</td> <td>18.15</td> <td>47.27</td> <td>54.00</td> <td>6.73</td> <td>Average</td> </tr> <tr> <td>6</td> <td>18000.00</td> <td>39.17</td> <td>18.15</td> <td>57.32</td> <td>74.00</td> <td>16.68</td> <td>Peak</td> </tr> </tbody> </table>		No.	Frequency (MHz)	Reading (dBuV)	Factor (dB/m)	Result (dBuV/m)	Limit (dBuV/m)	Margin (dB)	Detector	1	7236.00	36.92	1.79	38.71	54.00	15.29	Average	2	7236.00	46.40	1.79	48.19	74.00	25.81	Peak	3	17313.46	32.01	14.36	46.37	54.00	7.63	Average	4	17313.46	43.22	14.36	57.58	74.00	16.42	Peak	5	18000.00	29.12	18.15	47.27	54.00	6.73	Average	6	18000.00	39.17	18.15	57.32	74.00	16.68	Peak
No.	Frequency (MHz)	Reading (dBuV)	Factor (dB/m)	Result (dBuV/m)	Limit (dBuV/m)	Margin (dB)	Detector																																																																																																												
1	7236.00	36.85	1.79	38.64	54.00	15.36	Average																																																																																																												
2	7236.00	45.48	1.79	47.27	74.00	26.73	Peak																																																																																																												
3	16943.79	33.27	11.57	44.84	54.00	9.16	Average																																																																																																												
4	16943.79	45.54	11.57	57.11	74.00	16.89	Peak																																																																																																												
5	18000.00	28.96	18.15	47.11	54.00	6.89	Average																																																																																																												
6	18000.00	39.85	18.15	58.00	74.00	16.00	Peak																																																																																																												
No.	Frequency (MHz)	Reading (dBuV)	Factor (dB/m)	Result (dBuV/m)	Limit (dBuV/m)	Margin (dB)	Detector																																																																																																												
1	7236.00	36.92	1.79	38.71	54.00	15.29	Average																																																																																																												
2	7236.00	46.40	1.79	48.19	74.00	25.81	Peak																																																																																																												
3	17313.46	32.01	14.36	46.37	54.00	7.63	Average																																																																																																												
4	17313.46	43.22	14.36	57.58	74.00	16.42	Peak																																																																																																												
5	18000.00	29.12	18.15	47.27	54.00	6.73	Average																																																																																																												
6	18000.00	39.17	18.15	57.32	74.00	16.68	Peak																																																																																																												

802.11b mode, Low Channel, Bandedge, Horizontal

Project No.: DG2231214-75516E-RF
 Polarization: Horizontal
 Test Mode: Transmitting
 Note: 802.11b_low channel

Serial No.: 2F7I-7
 Tester: Leo Xiao

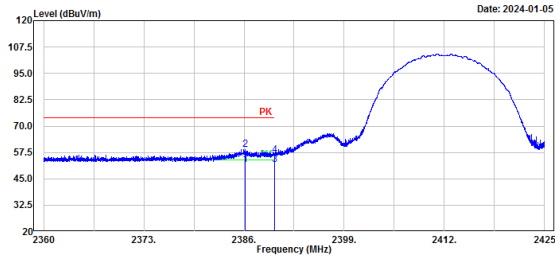

No.	Frequency (MHz)	Reading (dBμV)	Factor (dB/m)	Result (dBμV/m)	Limit (dBμV/m)	Margin (dB)	Detector
1	2386.12	23.31	28.55	51.86	54.00	2.14	Average
2	2386.12	30.29	28.55	58.84	74.00	15.16	Peak
3	2390.00	23.12	28.57	51.69	54.00	2.31	Average
4	2390.00	27.50	28.57	56.07	74.00	17.93	Peak

802.11b mode, Low Channel, Bandedge, Vertical

Project No.: DG2231214-75516E-RF
 Polarization: Vertical
 Test Mode: Transmitting
 Note: 802.11b_low channel

Serial No.: 2F7I-7
 Tester: Leo Xiao

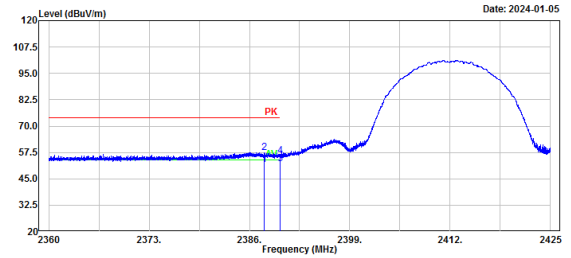

No.	Frequency (MHz)	Reading (dBμV)	Factor (dB/m)	Result (dBμV/m)	Limit (dBμV/m)	Margin (dB)	Detector
1	2387.87	23.15	28.56	51.71	54.00	2.29	Average
2	2387.87	28.79	28.56	57.35	74.00	16.65	Peak
3	2390.00	23.47	28.57	52.04	54.00	1.96	Average
4	2390.00	27.19	28.57	55.76	74.00	18.24	Peak

802.11b mode, Middle Channel, Horizontal

Project No.: DG2231214-75516E-RF
 Polarization: Horizontal
 Test Mode: Transmitting
 Note: 802.11b_middle channel

Serial No.: 2F7I-7
 Tester: Colin Yang

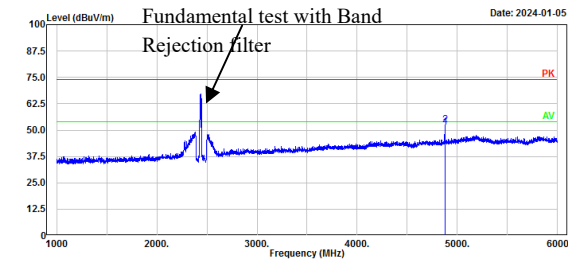

No.	Frequency (MHz)	Reading (dBuV)	Factor (dB/m)	Result (dBuV/m)	Limit (dBuV/m)	Margin (dB)	Detector
1	4874.00	54.08	-2.77	51.31	54.00	2.69	Average
2	4874.00	55.31	-2.77	52.54	74.00	21.46	Peak

802.11b mode, Middle Channel, Vertical

Project No.: DG2231214-75516E-RF
 Polarization: Vertical
 Test Mode: Transmitting
 Note: 802.11b_middle channel

Serial No.: 2F7I-7
 Tester: Colin Yang

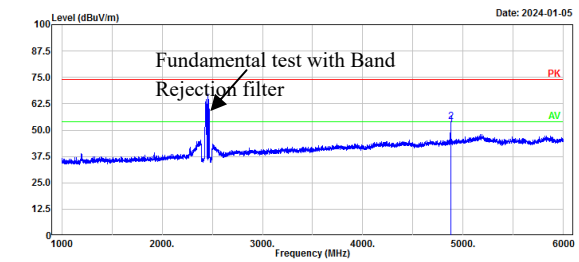

No.	Frequency (MHz)	Reading (dBuV)	Factor (dB/m)	Result (dBuV/m)	Limit (dBuV/m)	Margin (dB)	Detector
1	4874.00	55.15	-2.77	52.38	54.00	1.62	Average
2	4874.00	56.86	-2.77	54.09	74.00	19.91	Peak

Project No.: DG2231214-75516E-RF
 Polarization: Horizontal
 Test Mode: Transmitting
 Note: 802.11b_middle channel

Serial No.: 2F7I-7
 Tester: Colin Yang

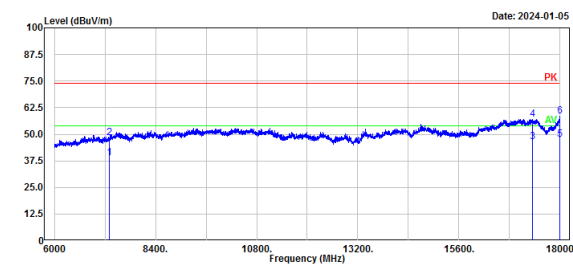

No.	Frequency (MHz)	Reading (dBuV)	Factor (dB/m)	Result (dBuV/m)	Limit (dBuV/m)	Margin (dB)	Detector
1	7311.00	36.78	2.08	38.86	54.00	15.14	Average
2	7311.00	46.16	2.08	48.24	74.00	25.76	Peak
3	17349.47	31.70	14.65	46.35	54.00	7.65	Average
4	17349.47	42.47	14.65	57.12	74.00	16.88	Peak
5	17992.80	29.33	18.12	47.45	54.00	6.55	Average
6	17992.80	40.47	18.12	58.59	74.00	15.41	Peak

Project No.: DG2231214-75516E-RF
 Polarization: Vertical
 Test Mode: Transmitting
 Note: 802.11b_middle channel

Serial No.: 2F7I-7
 Tester: Colin Yang

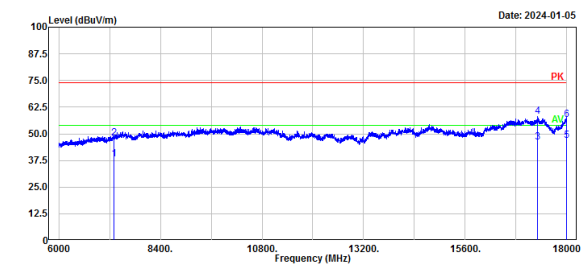

No.	Frequency (MHz)	Reading (dBuV)	Factor (dB/m)	Result (dBuV/m)	Limit (dBuV/m)	Margin (dB)	Detector
1	7311.00	36.12	2.08	38.20	54.00	15.80	Average
2	7311.00	45.92	2.08	48.00	74.00	26.00	Peak
3	17313.46	31.85	14.36	46.21	54.00	7.79	Average
4	17313.46	43.78	14.36	58.14	74.00	15.86	Peak
5	18000.00	28.74	18.15	46.89	54.00	7.11	Average
6	18000.00	38.55	18.15	56.70	74.00	17.30	Peak

802.11b mode, High Channel, Horizontal

Project No.: DG2231214-75516E-RF Serial No.: 2F7I-7
 Polarization: Horizontal Tester: Leo Xiao
 Test Mode: Transmitting
 Note: 802.11b_high channel

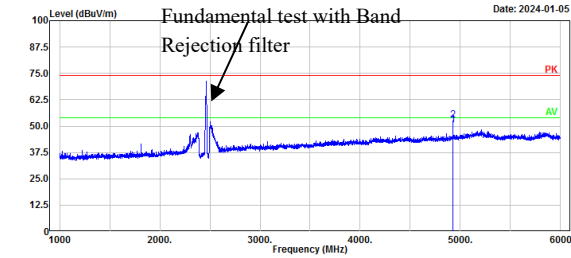

No.	Frequency (MHz)	Reading (dBuV)	Factor (dB/m)	Result (dBuV/m)	Limit (dBuV/m)	Margin (dB)	Detector
1	4924.00	52.91	-2.53	50.38	54.00	3.62	Average
2	4924.00	55.30	-2.53	52.77	74.00	21.23	Peak

802.11b mode, High Channel, Vertical

Project No.: DG2231214-75516E-RF Serial No.: 2F7I-7
 Polarization: Vertical Tester: Leo Xiao
 Test Mode: Transmitting
 Note: 802.11b_high channel

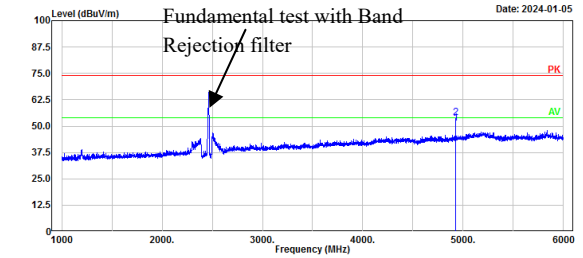

No.	Frequency (MHz)	Reading (dBuV)	Factor (dB/m)	Result (dBuV/m)	Limit (dBuV/m)	Margin (dB)	Detector
1	4924.00	53.76	-2.53	51.23	54.00	2.77	Average
2	4924.00	56.59	-2.53	54.06	74.00	19.94	Peak

Project No.: DG2231214-75516E-RF
 Polarization: Horizontal
 Test Mode: Transmitting
 Note: 802.11b_high channel

Serial No.: 2F7I-7
 Tester: Colin Yang

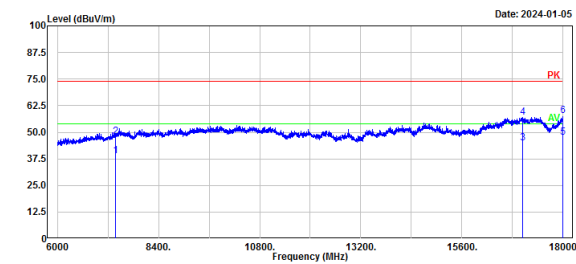

No.	Frequency (MHz)	Reading (dBuV)	Factor (dB/m)	Result (dBuV/m)	Limit (dBuV/m)	Margin (dB)	Detector
1	7386.00	36.45	2.25	38.70	54.00	15.30	Average
2	7386.00	45.77	2.25	48.02	74.00	25.98	Peak
3	17037.41	32.60	12.23	44.83	54.00	9.17	Average
4	17037.41	44.87	12.23	57.10	74.00	16.90	Peak
5	18000.00	29.35	18.15	47.50	54.00	6.50	Average
6	18000.00	39.53	18.15	57.68	74.00	16.32	Peak

Project No.: DG2231214-75516E-RF
 Polarization: Vertical
 Test Mode: Transmitting
 Note: 802.11b_high channel

Serial No.: 2F7I-7
 Tester: Colin Yang

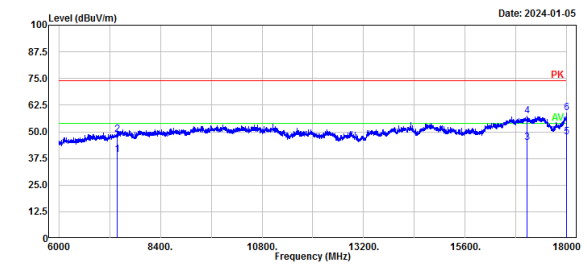

No.	Frequency (MHz)	Reading (dBuV)	Factor (dB/m)	Result (dBuV/m)	Limit (dBuV/m)	Margin (dB)	Detector
1	7386.00	36.89	2.25	39.14	54.00	14.86	Average
2	7386.00	46.40	2.25	48.65	74.00	25.35	Peak
3	17051.81	32.35	12.37	44.72	54.00	9.28	Average
4	17051.81	44.88	12.37	57.25	74.00	16.75	Peak
5	17995.20	29.45	18.13	47.58	54.00	6.42	Average
6	17995.20	40.92	18.13	59.05	74.00	14.95	Peak

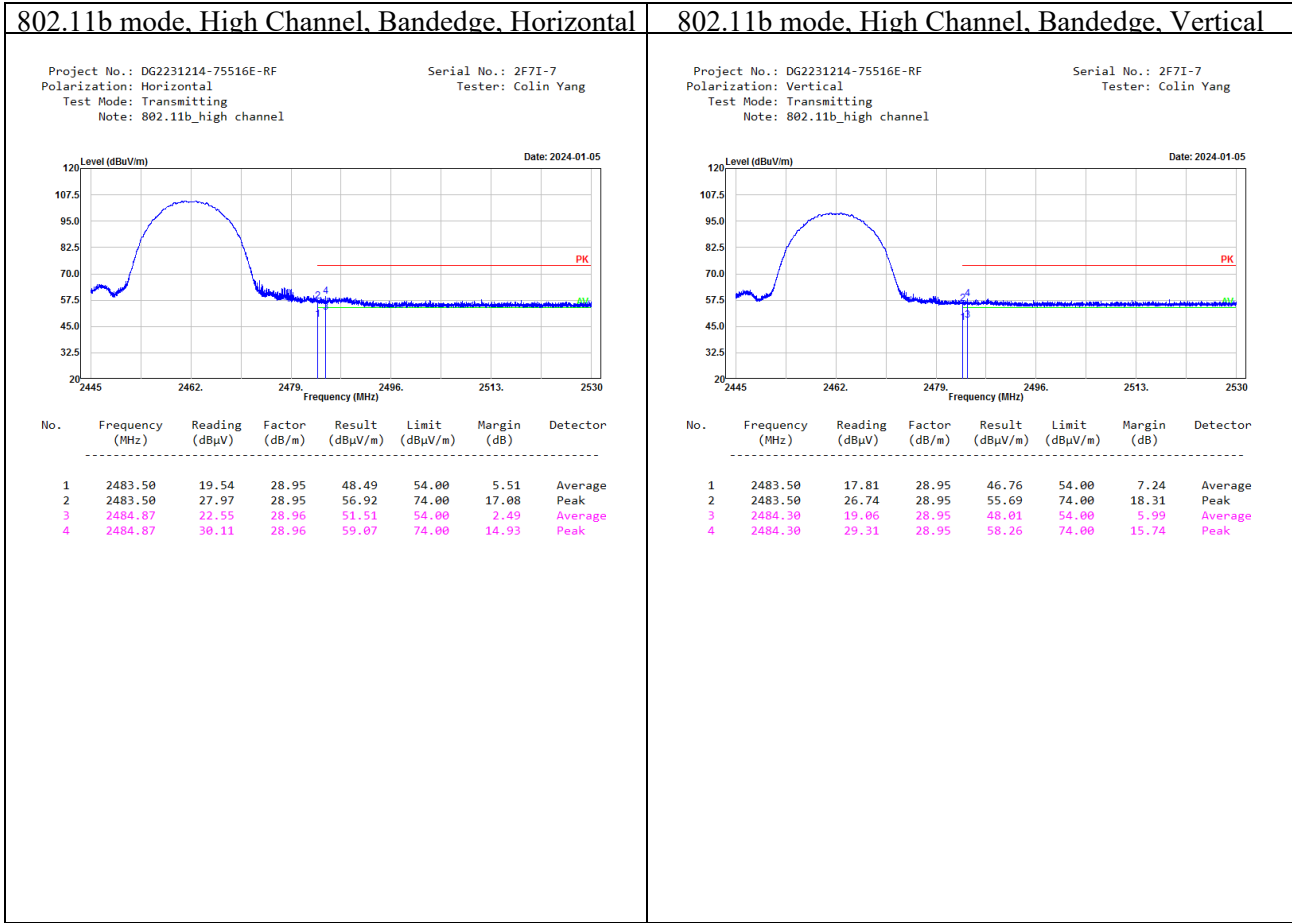

802.11g mode, Low Channel, Horizontal

Project No.: DG2231214-75516E-RF
 Polarization: Horizontal
 Test Mode: Transmitting
 Note: 802.11g_low channel

Serial No.: 2F7I-7
 Tester: Colin Yang

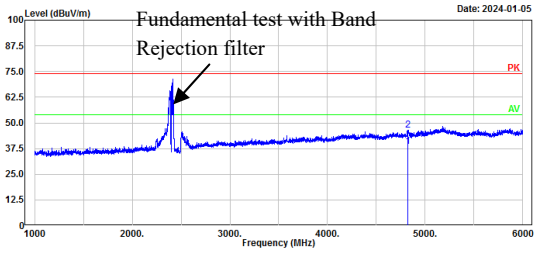

No.	Frequency (MHz)	Reading (dBuV)	Factor (dB/m)	Result (dBuV/m)	Limit (dBuV/m)	Margin (dB)	Detector
1	4824.00	41.44	-2.98	38.46	54.00	15.54	Average
2	4824.00	49.55	-2.98	46.57	74.00	27.43	Peak

802.11g mode, Low Channel, Vertical

Project No.: DG2231214-75516E-RF
 Polarization: Vertical
 Test Mode: Transmitting
 Note: 802.11g_low channel

Serial No.: 2F7I-7
 Tester: Colin Yang

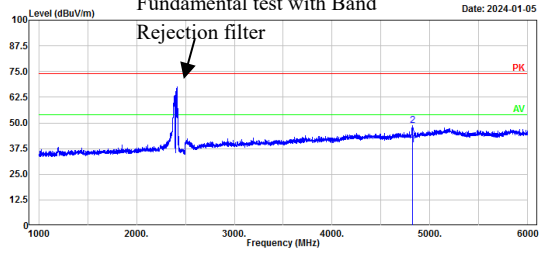

No.	Frequency (MHz)	Reading (dBuV)	Factor (dB/m)	Result (dBuV/m)	Limit (dBuV/m)	Margin (dB)	Detector
1	4824.00	42.25	-2.98	39.27	54.00	14.73	Average
2	4824.00	51.48	-2.98	48.50	74.00	25.50	Peak

Project No.: DG2231214-75516E-RF
 Polarization: Horizontal
 Test Mode: Transmitting
 Note: 802.11g_low channel

Serial No.: 2F7I-7
 Tester: Colin Yang

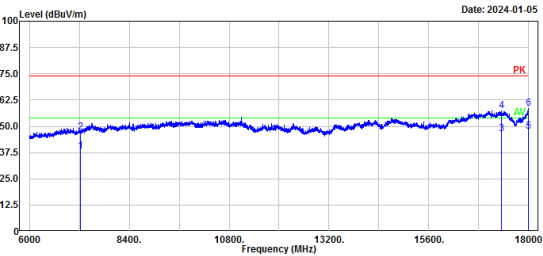

No.	Frequency (MHz)	Reading (dBuV)	Factor (dB/m)	Result (dBuV/m)	Limit (dBuV/m)	Margin (dB)	Detector
1	7236.00	36.32	1.79	38.11	54.00	15.89	Average
2	7236.00	45.37	1.79	47.16	74.00	26.84	Peak
3	17337.47	31.75	14.55	46.30	54.00	7.70	Average
4	17337.47	42.73	14.55	57.28	74.00	16.72	Peak
5	17992.80	29.26	18.12	47.38	54.00	6.62	Average
6	17992.80	40.32	18.12	58.44	74.00	15.56	Peak

Project No.: DG2231214-75516E-RF
 Polarization: Vertical
 Test Mode: Transmitting
 Note: 802.11g_low channel

Serial No.: 2F7I-7
 Tester: Colin Yang

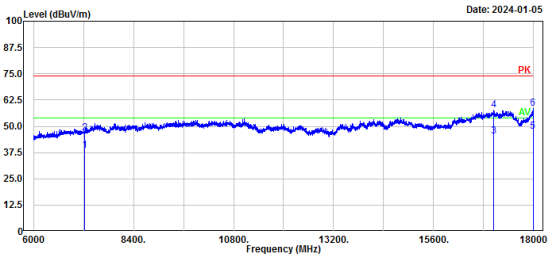

No.	Frequency (MHz)	Reading (dBuV)	Factor (dB/m)	Result (dBuV/m)	Limit (dBuV/m)	Margin (dB)	Detector
1	7236.00	36.57	1.79	38.36	54.00	15.64	Average
2	7236.00	45.11	1.79	46.90	74.00	27.10	Peak
3	17037.41	33.03	12.23	45.26	54.00	8.74	Average
4	17037.41	45.36	12.23	57.59	74.00	16.41	Peak
5	17983.20	29.41	18.09	47.50	54.00	6.50	Average
6	17983.20	40.45	18.09	58.54	74.00	15.46	Peak

802.11g mode, Low Channel, Bandedge, Horizontal

Project No.: DG2231214-75516E-RF
 Polarization: Horizontal
 Test Mode: Transmitting
 Note: 802.11g_low channel

Serial No.: 2F7I-7
 Tester: Colin Yang

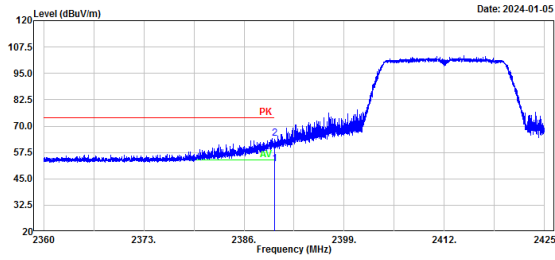

No.	Frequency (MHz)	Reading (dBμV)	Factor (dB/m)	Result (dBμV/m)	Limit (dBμV/m)	Margin (dB)	Detector
1	2390.00	23.41	28.57	51.98	54.00	2.02	Average
2	2390.00	35.51	28.57	64.08	74.00	9.92	Peak

802.11g mode, Low Channel, Bandedge, Vertical

Project No.: DG2231214-75516E-RF
 Polarization: Vertical
 Test Mode: Transmitting
 Note: 802.11g_low channel

Serial No.: 2F7I-7
 Tester: Colin Yang

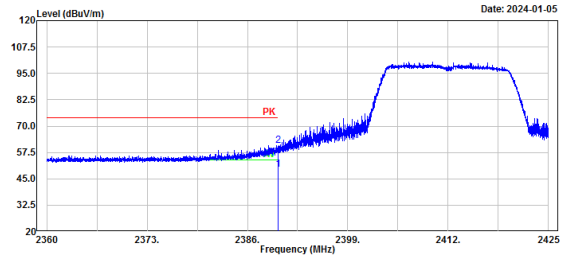

No.	Frequency (MHz)	Reading (dBμV)	Factor (dB/m)	Result (dBμV/m)	Limit (dBμV/m)	Margin (dB)	Detector
1	2390.00	20.73	28.57	49.30	54.00	4.70	Average
2	2390.00	32.35	28.57	60.92	74.00	13.08	Peak

802.11g mode, Middle Channel, Horizontal

Project No.: DG2231214-75516E-RF Serial No.: 2F7I-7
 Polarization: Horizontal Tester: Colin Yang
 Test Mode: Transmitting
 Note: 802.11g_middle channel

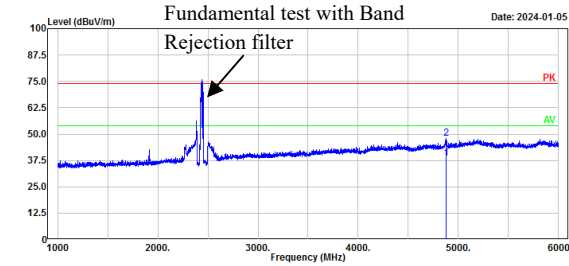

No.	Frequency (MHz)	Reading (dBuV)	Factor (dB/m)	Result (dBuV/m)	Limit (dBuV/m)	Margin (dB)	Detector
1	4874.00	41.33	-2.77	38.56	54.00	15.44	Average
2	4874.00	50.78	-2.77	48.01	74.00	25.99	Peak

802.11g mode, Middle Channel, Vertical

Project No.: DG2231214-75516E-RF Serial No.: 2F7I-7
 Polarization: Vertical Tester: Colin Yang
 Test Mode: Transmitting
 Note: 802.11g_middle channel

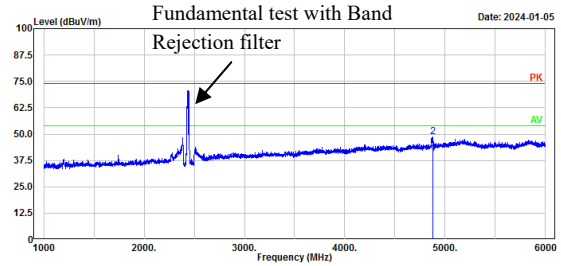

No.	Frequency (MHz)	Reading (dBuV)	Factor (dB/m)	Result (dBuV/m)	Limit (dBuV/m)	Margin (dB)	Detector
1	4874.00	43.40	-2.77	40.63	54.00	13.37	Average
2	4874.00	51.59	-2.77	48.82	74.00	25.18	Peak

Project No.: DG2231214-75516E-RF Serial No.: 2F7I-7
 Polarization: Horizontal Tester: Colin Yang
 Test Mode: Transmitting
 Note: 802.11g_middle channel

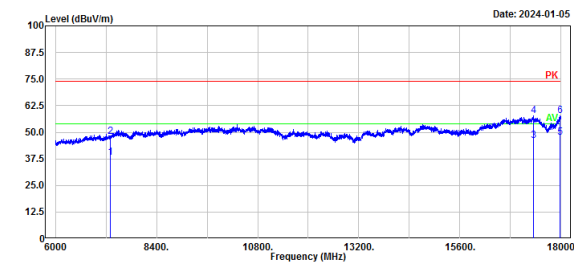

No.	Frequency (MHz)	Reading (dBuV)	Factor (dB/m)	Result (dBuV/m)	Limit (dBuV/m)	Margin (dB)	Detector
1	7311.00	36.18	2.08	38.26	54.00	15.74	Average
2	7311.00	45.85	2.08	47.93	74.00	26.07	Peak
3	17349.47	31.36	14.65	46.01	54.00	7.99	Average
4	17349.47	43.02	14.65	57.67	74.00	16.33	Peak
5	17980.80	29.45	18.08	47.53	54.00	6.47	Average
6	17980.80	39.69	18.08	57.77	74.00	16.23	Peak

Project No.: DG2231214-75516E-RF Serial No.: 2F7I-7
 Polarization: Vertical Tester: Colin Yang
 Test Mode: Transmitting
 Note: 802.11g_middle channel

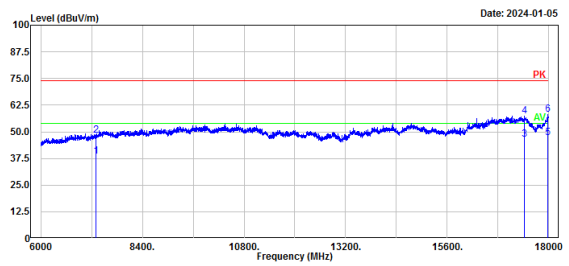

No.	Frequency (MHz)	Reading (dBuV)	Factor (dB/m)	Result (dBuV/m)	Limit (dBuV/m)	Margin (dB)	Detector
1	7311.00	36.34	2.08	38.42	54.00	15.58	Average
2	7311.00	46.04	2.08	48.12	74.00	25.88	Peak
3	17423.88	31.02	15.27	46.29	54.00	7.71	Average
4	17423.88	41.95	15.27	57.22	74.00	16.78	Peak
5	17976.00	29.16	18.05	47.21	54.00	6.79	Average
6	17976.00	39.91	18.05	57.96	74.00	16.04	Peak

802.11g mode, High Channel, Horizontal

Project No.: DG2231214-75516E-RF
 Polarization: Horizontal
 Test Mode: Transmitting
 Note: 802.11g_high channel

Serial No.: 2F7I-7
 Tester: Colin Yang

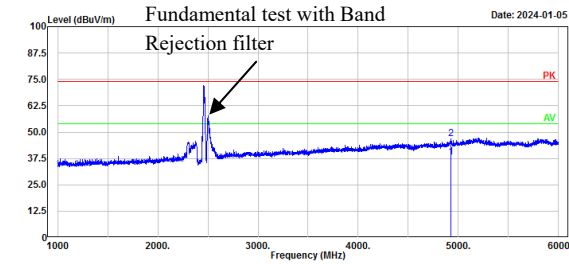

No.	Frequency (MHz)	Reading (dBuV)	Factor (dB/m)	Result (dBuV/m)	Limit (dBuV/m)	Margin (dB)	Detector
1	4924.00	40.46	-2.53	37.93	54.00	16.07	Average
2	4924.00	49.19	-2.53	46.66	74.00	27.34	Peak

802.11g mode, High Channel, Vertical

Project No.: DG2231214-75516E-RF
 Polarization: Vertical
 Test Mode: Transmitting
 Note: 802.11g_high channel

Serial No.: 2F7I-7
 Tester: Colin Yang

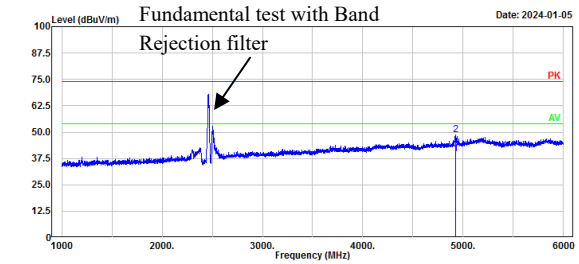

No.	Frequency (MHz)	Reading (dBuV)	Factor (dB/m)	Result (dBuV/m)	Limit (dBuV/m)	Margin (dB)	Detector
1	4924.00	41.98	-2.53	39.45	54.00	14.55	Average
2	4924.00	51.24	-2.53	48.71	74.00	25.29	Peak

Project No.: DG2231214-75516E-RF
 Polarization: Horizontal
 Test Mode: Transmitting
 Note: 802.11g_high channel

Serial No.: 2F7I-7
 Tester: Colin Yang

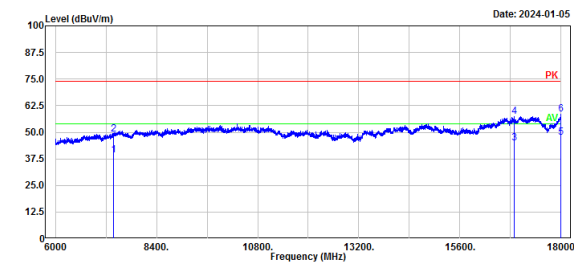

No.	Frequency (MHz)	Reading (dBuV)	Factor (dB/m)	Result (dBuV/m)	Limit (dBuV/m)	Margin (dB)	Detector
1	7386.00	36.89	2.25	39.14	54.00	14.86	Average
2	7386.00	46.87	2.25	49.12	74.00	24.88	Peak
3	16893.38	33.45	11.29	44.74	54.00	9.26	Average
4	16893.38	46.00	11.29	57.29	74.00	16.71	Peak
5	17995.20	29.57	18.13	47.70	54.00	6.30	Average
6	17995.20	40.20	18.13	58.33	74.00	15.67	Peak

Project No.: DG2231214-75516E-RF
 Polarization: Vertical
 Test Mode: Transmitting
 Note: 802.11g_high channel

Serial No.: 2F7I-7
 Tester: Colin Yang

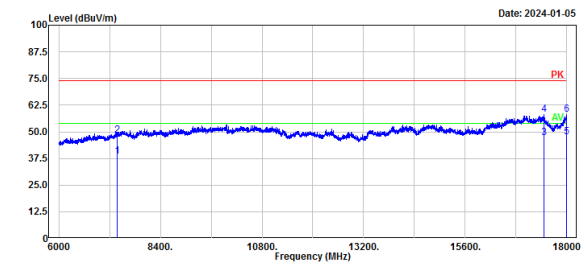

No.	Frequency (MHz)	Reading (dBuV)	Factor (dB/m)	Result (dBuV/m)	Limit (dBuV/m)	Margin (dB)	Detector
1	7386.00	36.42	2.25	38.67	54.00	15.33	Average
2	7386.00	46.18	2.25	48.43	74.00	25.57	Peak
3	17455.09	31.56	15.51	47.07	54.00	6.93	Average
4	17455.09	42.50	15.51	58.01	74.00	15.99	Peak
5	17997.60	29.31	18.14	47.45	54.00	6.55	Average
6	17997.60	39.82	18.14	57.96	74.00	16.04	Peak

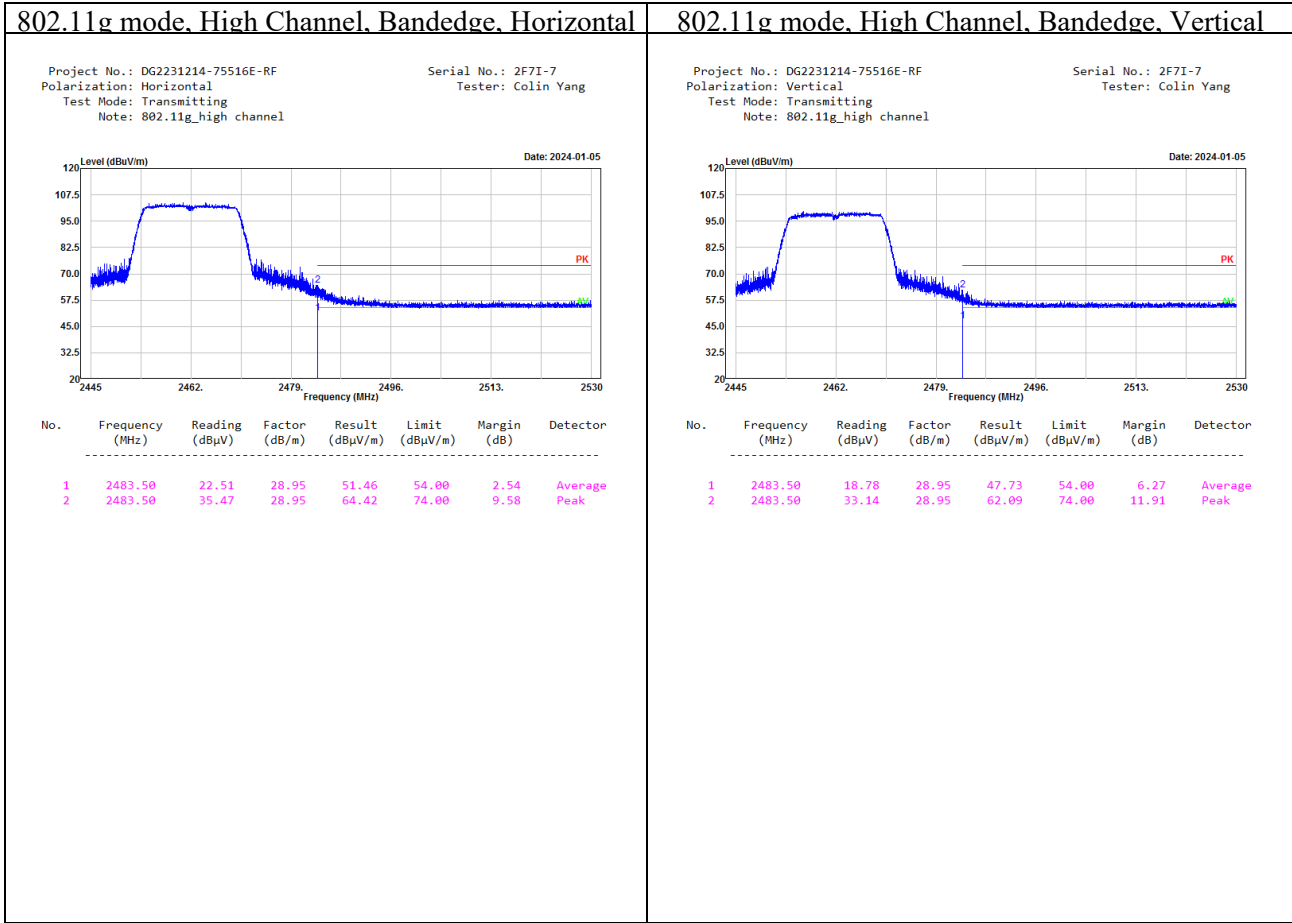

802.11n ht20 mode, Low Channel, Horizontal

Project No.: DG2231214-75516E-RF
 Polarization: Horizontal
 Test Mode: Transmitting
 Note: 802.11n20_low channel

Serial No.: 2F7I-7
 Tester: Colin Yang

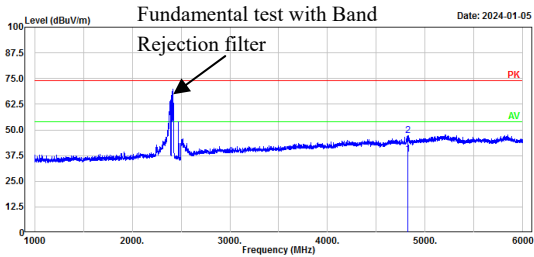

No.	Frequency (MHz)	Reading (dBuV)	Factor (dB/m)	Result (dBuV/m)	Limit (dBuV/m)	Margin (dB)	Detector
1	4824.00	48.96	-2.98	37.98	54.00	16.02	Average
2	4824.00	58.30	-2.98	47.32	74.00	26.68	Peak

802.11n ht20 mode, Low Channel, Vertical

Project No.: DG2231214-75516E-RF
 Polarization: Vertical
 Test Mode: Transmitting
 Note: 802.11n20_low channel

Serial No.: 2F7I-7
 Tester: Colin Yang

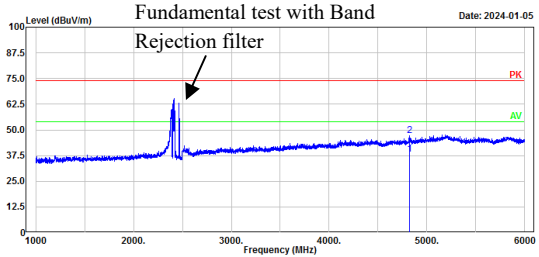

No.	Frequency (MHz)	Reading (dBuV)	Factor (dB/m)	Result (dBuV/m)	Limit (dBuV/m)	Margin (dB)	Detector
1	4824.00	41.27	-2.98	38.29	54.00	15.71	Average
2	4824.00	50.07	-2.98	47.09	74.00	26.91	Peak

Project No.: DG2231214-75516E-RF
 Polarization: Horizontal
 Test Mode: Transmitting
 Note: 802.11n20_low channel

Serial No.: 2F7I-7
 Tester: Colin Yang

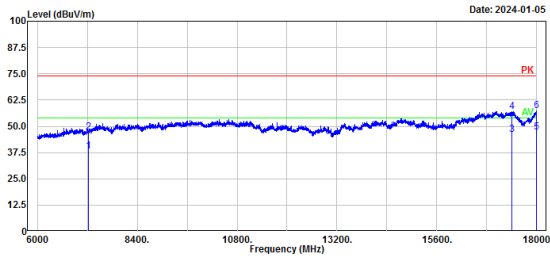

No.	Frequency (MHz)	Reading (dBuV)	Factor (dB/m)	Result (dBuV/m)	Limit (dBuV/m)	Margin (dB)	Detector
1	7236.00	36.38	1.79	38.17	54.00	15.83	Average
2	7236.00	45.27	1.79	47.06	74.00	26.94	Peak
3	17399.88	31.05	15.08	46.13	54.00	7.87	Average
4	17399.88	41.99	15.08	57.07	74.00	16.93	Peak
5	17992.80	29.11	18.12	47.23	54.00	6.77	Average
6	17992.80	39.13	18.12	57.25	74.00	16.75	Peak

Project No.: DG2231214-75516E-RF
 Polarization: Vertical
 Test Mode: Transmitting
 Note: 802.11n20_low channel

Serial No.: 2F7I-7
 Tester: Colin Yang

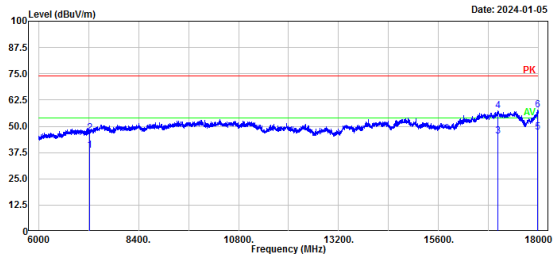

No.	Frequency (MHz)	Reading (dBuV)	Factor (dB/m)	Result (dBuV/m)	Limit (dBuV/m)	Margin (dB)	Detector
1	7236.00	36.62	1.79	38.41	54.00	15.59	Average
2	7236.00	45.11	1.79	46.90	74.00	27.10	Peak
3	17018.20	33.21	12.06	45.27	54.00	8.73	Average
4	17018.20	45.15	12.06	57.21	74.00	16.79	Peak
5	17973.59	29.16	18.05	47.21	54.00	6.79	Average
6	17973.59	39.69	18.05	57.74	74.00	16.26	Peak

802.11n ht20 mode, Low Channel, Bandedge, Horizontal

802.11n ht20 mode, Low Channel, Bandedge, Vertical

Project No.: DG2231214-75516E-RF
 Polarization: Horizontal
 Test Mode: Transmitting
 Note: 802.11n20_low channel

Serial No.: 2F7I-7
 Tester: Colin Yang

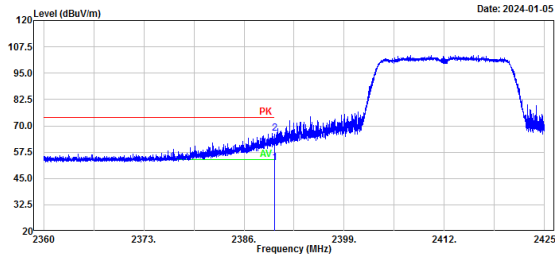

No.	Frequency (MHz)	Reading (dBuV)	Factor (dB/m)	Result (dBuV/m)	Limit (dBuV/m)	Margin (dB)	Detector
1	2390.00	23.95	28.57	52.52	54.00	1.48	Average
2	2390.00	37.99	28.57	66.56	74.00	7.44	Peak

Project No.: DG2231214-75516E-RF
 Polarization: Vertical
 Test Mode: Transmitting
 Note: 802.11n20_low channel

Serial No.: 2F7I-7
 Tester: Colin Yang

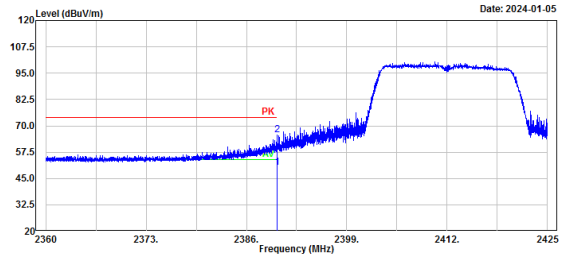

No.	Frequency (MHz)	Reading (dBuV)	Factor (dB/m)	Result (dBuV/m)	Limit (dBuV/m)	Margin (dB)	Detector
1	2390.00	21.75	28.57	50.32	54.00	3.68	Average
2	2390.00	36.96	28.57	65.53	74.00	8.47	Peak

802.11n ht20 mode, Middle Channel, Horizontal

Project No.: DG2231214-75516E-RF
 Polarization: Horizontal
 Test Mode: Transmitting
 Note: 802.11n20_middle channel

Serial No.: 2F7I-7
 Tester: Colin Yang

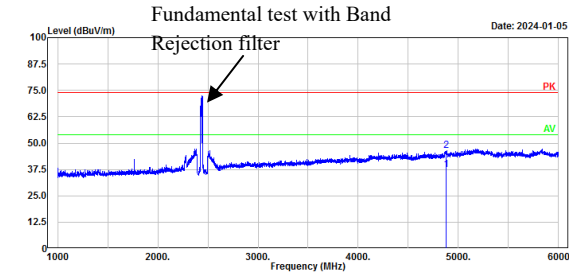

No.	Frequency (MHz)	Reading (dBuV)	Factor (dB/m)	Result (dBuV/m)	Limit (dBuV/m)	Margin (dB)	Detector
1	4874.00	40.19	-2.77	37.42	54.00	16.58	Average
2	4874.00	49.06	-2.77	46.29	74.00	27.71	Peak

802.11n ht20 mode, Middle Channel, Vertical

Project No.: DG2231214-75516E-RF
 Polarization: Vertical
 Test Mode: Transmitting
 Note: 802.11n20_middle channel

Serial No.: 2F7I-7
 Tester: Colin Yang

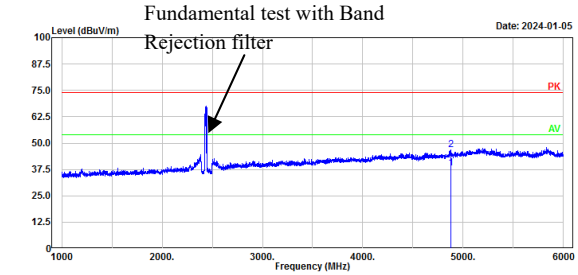

No.	Frequency (MHz)	Reading (dBuV)	Factor (dB/m)	Result (dBuV/m)	Limit (dBuV/m)	Margin (dB)	Detector
1	4874.00	40.99	-2.77	38.22	54.00	15.78	Average
2	4874.00	49.53	-2.77	46.76	74.00	27.24	Peak

Project No.: DG2231214-75516E-RF
 Polarization: Horizontal
 Test Mode: Transmitting
 Note: 802.11n20_middle channel

Serial No.: 2F7I-7
 Tester: Colin Yang

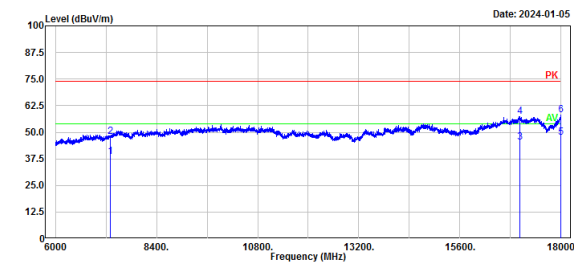

No.	Frequency (MHz)	Reading (dBuV)	Factor (dB/m)	Result (dBuV/m)	Limit (dBuV/m)	Margin (dB)	Detector
1	7311.00	36.59	2.08	38.67	54.00	15.33	Average
2	7311.00	45.89	2.08	47.97	74.00	26.03	Peak
3	17027.80	33.24	12.15	45.39	54.00	8.61	Average
4	17027.80	45.20	12.15	57.35	74.00	16.65	Peak
5	17995.20	29.27	18.13	47.40	54.00	6.60	Average
6	17995.20	40.16	18.13	58.29	74.00	15.71	Peak

Project No.: DG2231214-75516E-RF
 Polarization: Vertical
 Test Mode: Transmitting
 Note: 802.11n20_middle channel

Serial No.: 2F7I-7
 Tester: Colin Yang

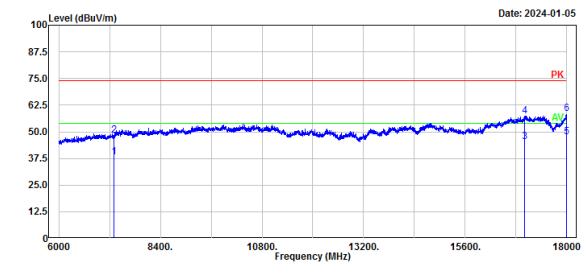

No.	Frequency (MHz)	Reading (dBuV)	Factor (dB/m)	Result (dBuV/m)	Limit (dBuV/m)	Margin (dB)	Detector
1	7311.00	36.22	2.08	38.30	54.00	15.70	Average
2	7311.00	46.16	2.08	48.24	74.00	25.76	Peak
3	17001.40	33.48	11.91	45.39	54.00	8.61	Average
4	17001.40	45.55	11.91	57.46	74.00	16.54	Peak
5	18000.00	29.41	18.15	47.56	54.00	6.44	Average
6	18000.00	40.30	18.15	58.45	74.00	15.55	Peak

802.11n ht20 mode, High Channel, Horizontal

Project No.: DG2231214-75516E-RF
 Polarization: Horizontal
 Test Mode: Transmitting
 Note: 802.11n20_high channel

Serial No.: 2F7I-7
 Tester: Colin Yang

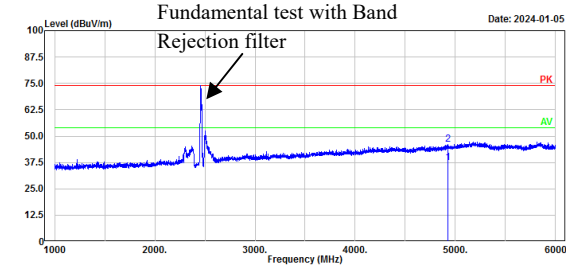

No.	Frequency (MHz)	Reading (dBuV)	Factor (dB/m)	Result (dBuV/m)	Limit (dBuV/m)	Margin (dB)	Detector
1	4924.00	40.03	-2.53	37.50	54.00	16.50	Average
2	4924.00	48.72	-2.53	46.19	74.00	27.81	Peak

802.11n ht20 mode, High Channel, Vertical

Project No.: DG2231214-75516E-RF
 Polarization: Vertical
 Test Mode: Transmitting
 Note: 802.11n20_high channel

Serial No.: 2F7I-7
 Tester: Colin Yang

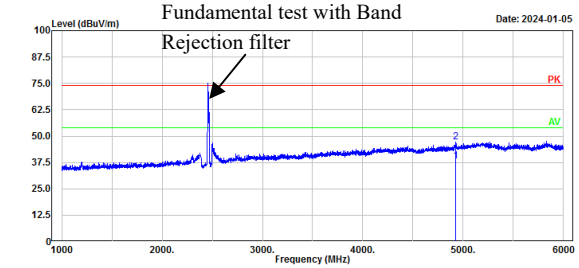

No.	Frequency (MHz)	Reading (dBuV)	Factor (dB/m)	Result (dBuV/m)	Limit (dBuV/m)	Margin (dB)	Detector
1	4924.00	40.78	-2.53	38.25	54.00	15.75	Average
2	4924.00	49.77	-2.53	47.24	74.00	26.76	Peak

Project No.: DG2231214-75516E-RF
 Polarization: Horizontal
 Test Mode: Transmitting
 Note: 802.11n20_high channel

Serial No.: 2F7I-7
 Tester: Colin Yang

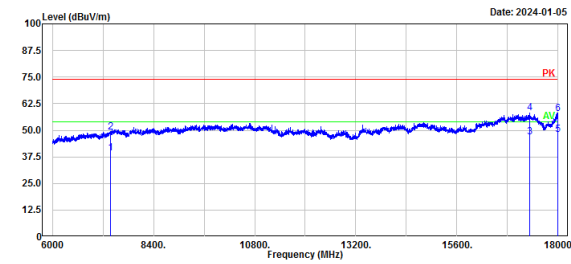

No.	Frequency (MHz)	Reading (dBuV)	Factor (dB/m)	Result (dBuV/m)	Limit (dBuV/m)	Margin (dB)	Detector
1	7386.00	36.87	2.25	39.12	54.00	14.88	Average
2	7386.00	46.86	2.25	49.11	74.00	24.89	Peak
3	17325.46	32.27	14.45	46.72	54.00	7.28	Average
4	17325.46	43.69	14.45	58.14	74.00	15.86	Peak
5	18000.00	29.64	18.15	47.79	54.00	6.21	Average
6	18000.00	39.59	18.15	57.74	74.00	16.26	Peak

Project No.: DG2231214-75516E-RF
 Polarization: Vertical
 Test Mode: Transmitting
 Note: 802.11n20_high channel

Serial No.: 2F7I-7
 Tester: Colin Yang

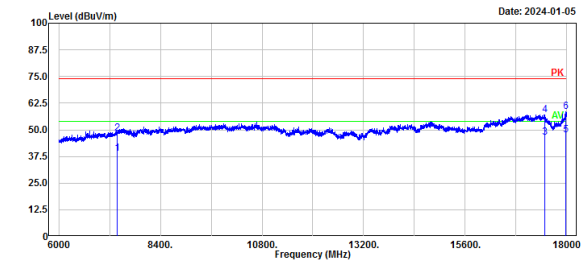

No.	Frequency (MHz)	Reading (dBuV)	Factor (dB/m)	Result (dBuV/m)	Limit (dBuV/m)	Margin (dB)	Detector
1	7386.00	36.58	2.25	38.83	54.00	15.17	Average
2	7386.00	46.04	2.25	48.29	74.00	25.71	Peak
3	17471.89	30.58	15.65	46.23	54.00	7.77	Average
4	17471.89	41.43	15.65	57.08	74.00	16.92	Peak
5	17978.40	29.58	18.07	47.65	54.00	6.35	Average
6	17978.40	40.50	18.07	58.57	74.00	15.43	Peak

802.11n ht20 mode, High Channel, Bandedge, Horizontal

Project No.: DG2231214-75516E-RF
 Polarization: Horizontal
 Test Mode: Transmitting
 Note: 802.11n20_high channel

Serial No.: 2F7I-7
 Tester: Colin Yang

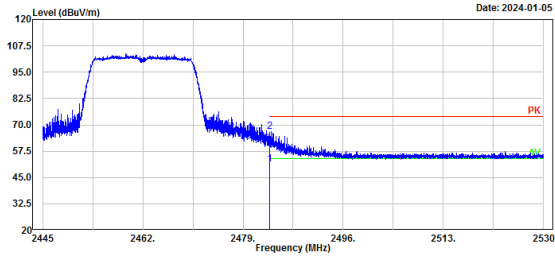

No.	Frequency (MHz)	Reading (dBuV)	Factor (dB/m)	Result (dBuV/m)	Limit (dBuV/m)	Margin (dB)	Detector
1	2483.50	22.35	28.95	51.30	54.00	2.70	Average
2	2483.50	37.69	28.95	66.64	74.00	7.36	Peak

802.11n ht20 mode, High Channel, Bandedge, Vertical

Project No.: DG2231214-75516E-RF
 Polarization: Vertical
 Test Mode: Transmitting
 Note: 802.11n20_high channel

Serial No.: 2F7I-7
 Tester: Colin Yang

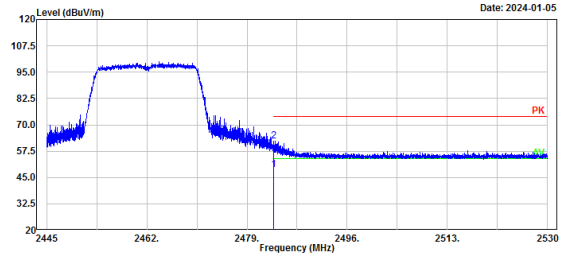

No.	Frequency (MHz)	Reading (dBuV)	Factor (dB/m)	Result (dBuV/m)	Limit (dBuV/m)	Margin (dB)	Detector
1	2483.50	19.87	28.95	48.82	54.00	5.18	Average
2	2483.50	33.19	28.95	62.14	74.00	11.86	Peak

18-25GHz:

No Emission was detected in the range 18-25GHz, test was performed on the mode and channel which with the maximum power.

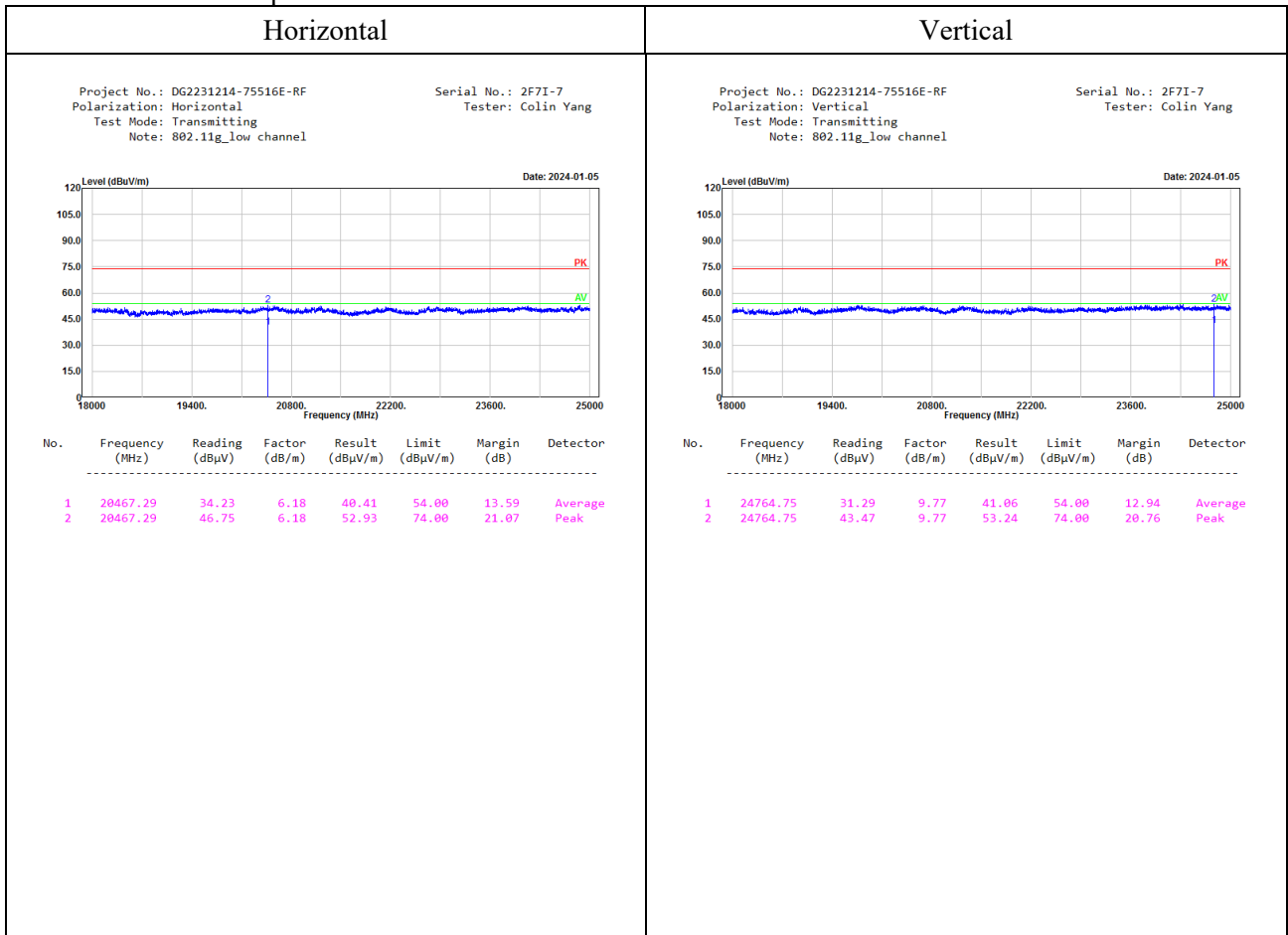

5.3 Minimum 6 dB Emission Bandwidth

Serial No.:	2F7I-8	Test Date:	2024-01-09
Test Site:	RF	Test Mode:	Transmitting
Tester:	Jojo Zhou	Test Result:	Pass

Environmental Conditions:

Temperature: (°C)	24.8	Relative Humidity: (%)	41	ATM Pressure: (kPa)	101.2
-----------------------------	------	----------------------------------	----	-------------------------------	-------

Test Equipment List and Details:

Manufacturer	Description	Model	Serial Number	Calibration Date	Calibration Due Date
R&S	Spectrum Analyzer	FSV40	101947	2023-10-18	2024-10-17
E-Microwave	Blocking Control	EMDCB-00036	OE01201047	2023-05-06	2024-05-05
yzjingcheng	Coaxial Cable	KTRFBU-141-50	41010012	2023-09-01	2024-08-31

* Statement of Traceability: Bay Area Compliance Laboratories Corp. (Dongguan) attests that all calibrations have been performed, traceable to National Primary Standards and International System of Units (SI).

Test Data:

Mode	Value (MHz)	Limit (MHz)	Result
b_2412MHz_Chain 0	10.150	0.5	Pass
b_2437MHz_Chain 0	10.150	0.5	Pass
b_2462MHz_Chain 0	10.150	0.5	Pass
g_2412MHz_Chain 0	16.464	0.5	Pass
g_2437MHz_Chain 0	16.464	0.5	Pass
g_2462MHz_Chain 0	16.464	0.5	Pass
n20_2412MHz_Chain 0	17.223	0.5	Pass
n20_2437MHz_Chain 0	17.183	0.5	Pass
n20_2462MHz_Chain 0	17.383	0.5	Pass

b_2412MHz

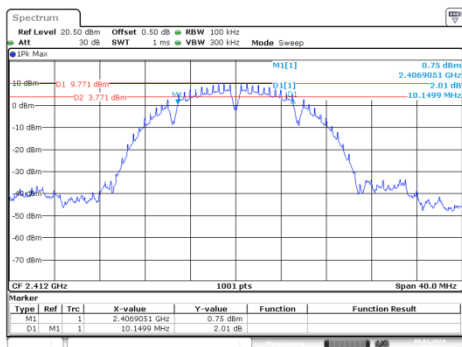

b_2437MHz

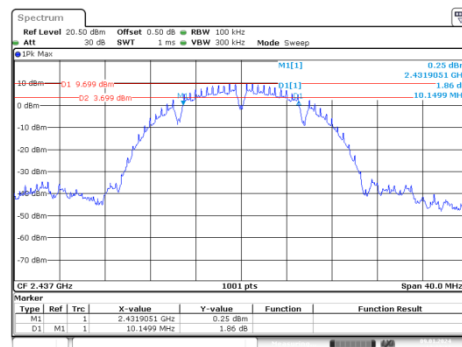

b_2462MHz

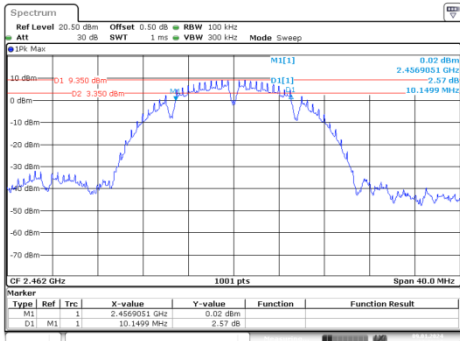

ProjectNo.:DG2231214-75516E-RF TesteriJojo Zhou
Date: 9-Jan-2024 17:16:12

g_2412MHz

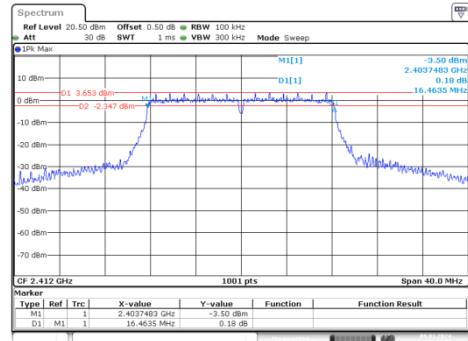

ProjectNo.:DG2231214-75516E-RF TesteriJojo Zhou
Date: 9-Jan-2024 18:11:50

g_2437MHz

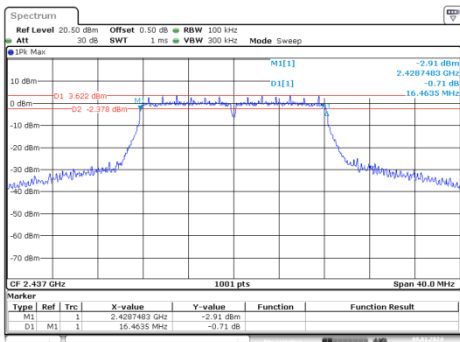

ProjectNo.:DG2231214-75516E-RF TesteriJojo Zhou
Date: 9-Jan-2024 17:58:26

g_2462MHz

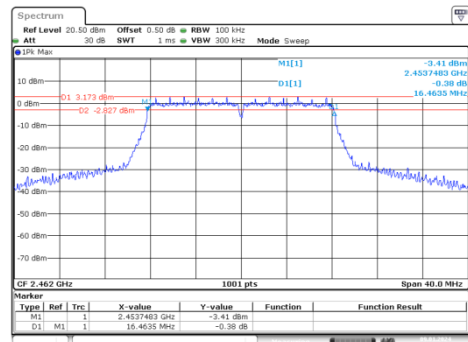

ProjectNo.:DG2231214-75516E-RF TesteriJojo Zhou
Date: 9-Jan-2024 18:23:58

n20_2412MHz

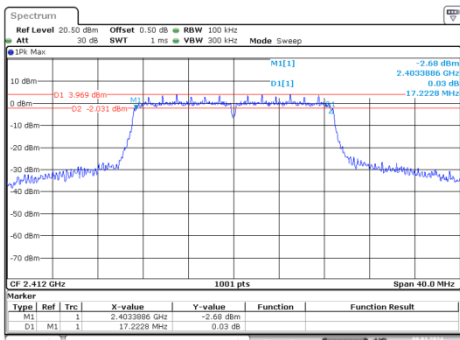

ProjectNo.:DG2231214-75516E-RF TesteriJojo Zhou
Date: 9-Jan-2024 19:12:25

n20_2437MHz

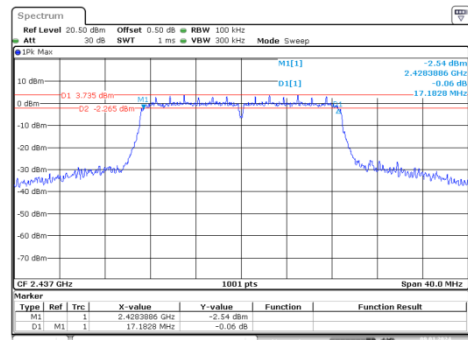

ProjectNo.:DG2231214-75516E-RF TesteriJojo Zhou
Date: 9-Jan-2024 19:15:51

n20_2462MHz

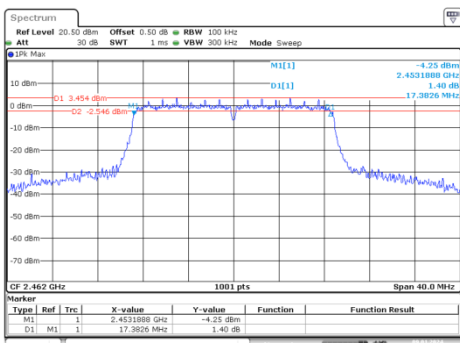

ProjectNo.:DG2231214-75516E-RF TesteriJojo Zhou
Date: 9-Jan-2024 19:27:07

5.4 99% Occupied Bandwidth

Serial No.:	2F7I-8	Test Date:	2024-01-09
Test Site:	RF	Test Mode:	Transmitting
Tester:	Jojo Zhou	Test Result:	Pass

Environmental Conditions:

Temperature: (°C)	24.8	Relative Humidity: (%)	41	ATM Pressure: (kPa)	101.2
-----------------------------	------	----------------------------------	----	-------------------------------	-------

Test Equipment List and Details:

Manufacturer	Description	Model	Serial Number	Calibration Date	Calibration Due Date
R&S	Spectrum Analyzer	FSV40	101947	2023-10-18	2024-10-17
E-Microwave	Blocking Control	EMDCB-00036	OE01201047	2023-05-06	2024-05-05
yzjingcheng	Coaxial Cable	KTRFBU-141-50	41010012	2023-09-01	2024-08-31

* Statement of Traceability: Bay Area Compliance Laboratories Corp. (Dongguan) attests that all calibrations have been performed, traceable to National Primary Standards and International System of Units (SI).

Test Data:

Mode	99% OBW (MHz)
b_2412MHz_Chain 0	14.945
b_2437MHz_Chain 0	14.945
b_2462MHz_Chain 0	14.945
g_2412MHz_Chain 0	16.543
g_2437MHz_Chain 0	16.583
g_2462MHz_Chain 0	16.583
n20_2412MHz_Chain 0	17.582
n20_2437MHz_Chain 0	17.582
n20_2462MHz_Chain 0	17.542

b_2412MHz

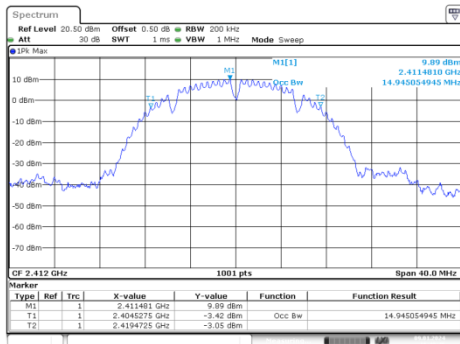

ProjectNo.:DG2231214-75516E-RF Tester:Jojo Zhou
Date: 9_JAN.2024 16:48:45

b_2437MHz

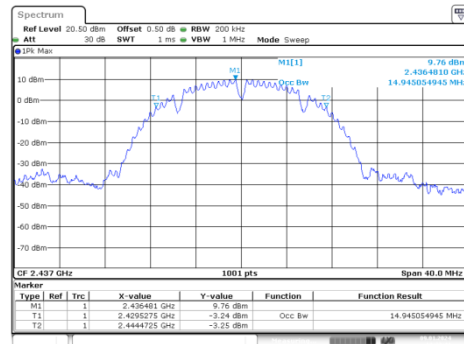

ProjectNo.:DG2231214-75516E-RF Testers:Jojo Zhou
Date: 9_JAN.2024 17:13:41

b_2462MHz

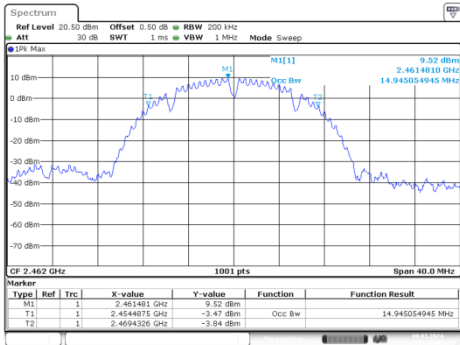

ProjectNo.:DG2231214-75516E-RF Tester:Jojo Zhou
Date: 9-Jan-2024 17:17:08

g_2412MHz

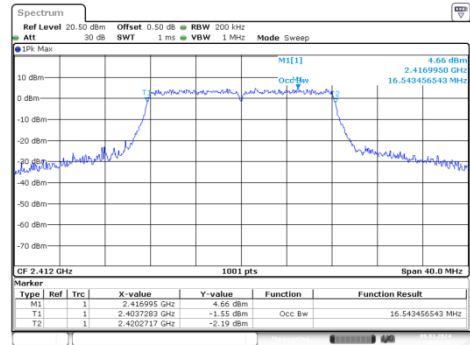

ProjectNo.:DG2231214-75516E-RF Tester:Jojo Zhou
Date: 9-Jan-2024 18:11:47

g_2437MHz

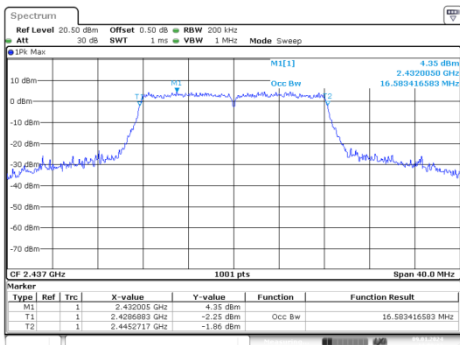

ProjectNo.:DG2231214-75516E-RF Tester:Jojo Zhou
Date: 9-Jan-2024 17:55:12

g_2462MHz

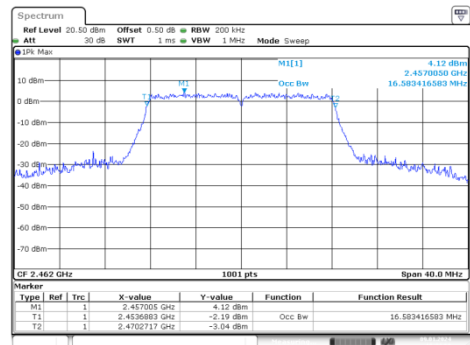

ProjectNo.:DG2231214-75516E-RF Tester:Jojo Zhou
Date: 9-Jan-2024 18:24:50

n20_2412MHz

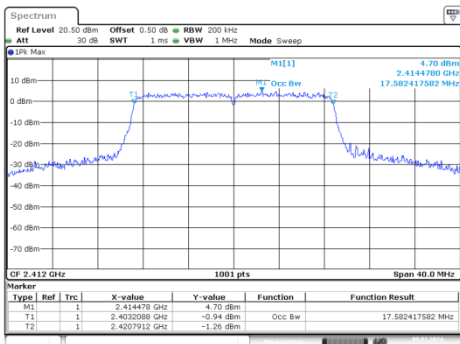

ProjectNo.:DG2231214-75516E-RF Tester:Jojo Zhou
Date: 9-Jan-2024 19:13:07

n20_2437MHz

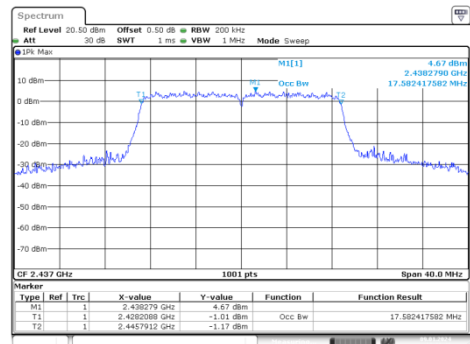

ProjectNo.:DG2231214-75516E-RF Tester:Jojo Zhou
Date: 9-Jan-2024 19:20:48

n20_2462MHz

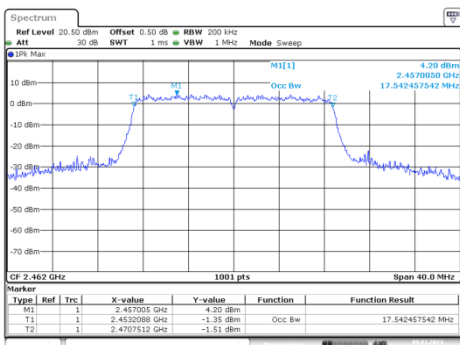

ProjectNo.:DG2231214-75516E-RF Tester:Jojo Zhou
Date: 9-Jan-2024 19:28:05

5.5 Maximum Conducted Output Power

Serial No.:	2F7I-8	Test Date:	2024-01-09
Test Site:	RF	Test Mode:	Transmitting
Tester:	Jojo Zhou	Test Result:	Pass

Environmental Conditions:

Temperature: (°C)	24.8	Relative Humidity: (%)	41	ATM Pressure: (kPa)	101.2
-----------------------------	------	----------------------------------	----	-------------------------------	-------

Test Equipment List and Details:

Manufacturer	Description	Model	Serial Number	Calibration Date	Calibration Due Date
Anritsu	Microwave Peak Power Sensor	MA24418A	12618	2023-09-04	2024-09-03
E-Microwave	Blocking Control	EMDCB-00036	OE01201047	2023-05-06	2024-05-05
yzjingcheng	Coaxial Cable	KTRFBU-141-50	41010012	2023-09-01	2024-08-31

* Statement of Traceability: Bay Area Compliance Laboratories Corp. (Dongguan) attests that all calibrations have been performed, traceable to National Primary Standards and International System of Units (SI).

Test Data:

Mode	Conducted Peak Output Power (dBm)	Limit (dBm)	Result
b_2412MHz_Chain 0	20.232	30.00	Pass
b_2437MHz_Chain 0	20.058	30.00	Pass
b_2462MHz_Chain 0	19.924	30.00	Pass
g_2412MHz_Chain 0	23.449	30.00	Pass
g_2437MHz_Chain 0	23.347	30.00	Pass
g_2462MHz_Chain 0	23.104	30.00	Pass
n20_2412MHz_Chain 0	23.404	30.00	Pass
n20_2437MHz_Chain 0	23.363	30.00	Pass
n20_2462MHz_Chain 0	23.134	30.00	Pass

5.6 Maximum Power Spectral Density

Serial No.:	2F7I-8	Test Date:	2024-01-09
Test Site:	RF	Test Mode:	Transmitting
Tester:	Jojo Zhou	Test Result:	Pass

Environmental Conditions:

Temperature: (°C)	24.8	Relative Humidity: (%)	41	ATM Pressure: (kPa)	101.2
-----------------------------	------	----------------------------------	----	-------------------------------	-------

Test Equipment List and Details:

Manufacturer	Description	Model	Serial Number	Calibration Date	Calibration Due Date
R&S	Spectrum Analyzer	FSV40	101947	2023-10-18	2024-10-17
E-Microwave	Blocking Control	EMDCB-00036	OE01201047	2023-05-06	2024-05-05
yzjingcheng	Coaxial Cable	KTRFBU-141-50	41010012	2023-09-01	2024-08-31

* Statement of Traceability: Bay Area Compliance Laboratories Corp. (Dongguan) attests that all calibrations have been performed, traceable to National Primary Standards and International System of Units (SI).

Test Data:

Mode	Value (dBm/3kHz)	Limit (dBm/3kHz)	Result
b_2412MHz_Chain 0	-1.50	8.00	Pass
b_2437MHz_Chain 0	-1.96	8.00	Pass
b_2462MHz_Chain 0	-2.29	8.00	Pass
g_2412MHz_Chain 0	-9.68	8.00	Pass
g_2437MHz_Chain 0	-9.52	8.00	Pass
g_2462MHz_Chain 0	-9.67	8.00	Pass
n20_2412MHz_Chain 0	-9.11	8.00	Pass
n20_2437MHz_Chain 0	-9.55	8.00	Pass
n20_2462MHz_Chain 0	-10.49	8.00	Pass

b_2412MHz

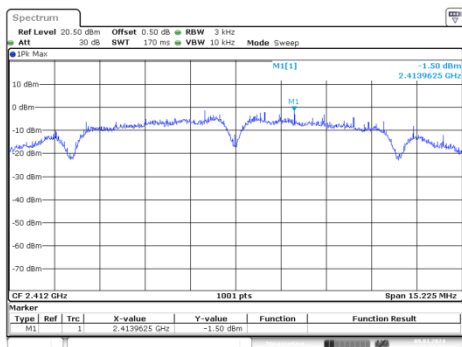

ProjectNo.:DG2231214-75516E-RF Tester:Jojo Zhou
Date: 9_JAN,2024 16:51:02

b_2437MHz

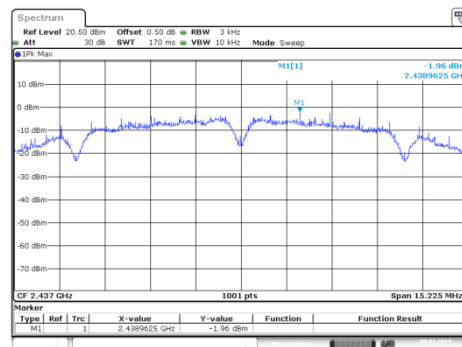

ProjectNo.:DG2231214-75516E-RF Tester:Jojo Zhou
Date: 9_JAN,2024 17:18:19

b_2462MHz

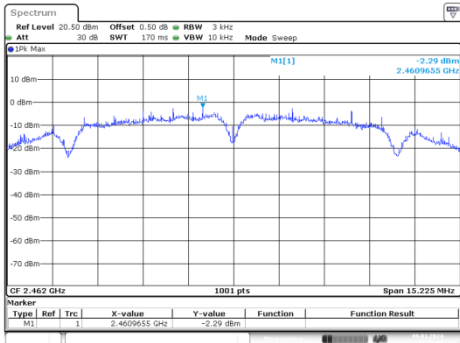

ProjectNo.:DG2231214-75516E-RF Tester:Jolojo Zhou
Date: 9-Jan-2024 17:38:02

g_2412MHz

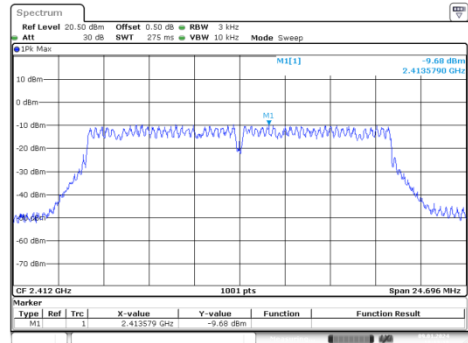

ProjectNo.:DG2231214-75516E-RF Tester:Jolojo Zhou
Date: 9-Jan-2024 18:13:18

g_2437MHz

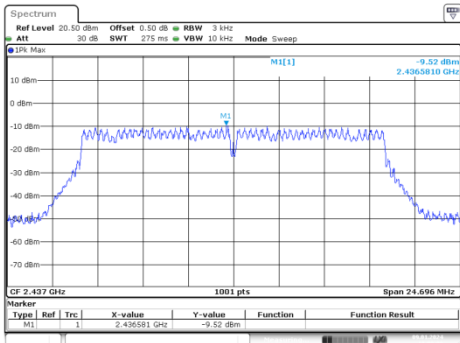

ProjectNo.:DG2231214-75516E-RF Tester:Jolojo Zhou
Date: 9-Jan-2024 18:00:09

g_2462MHz

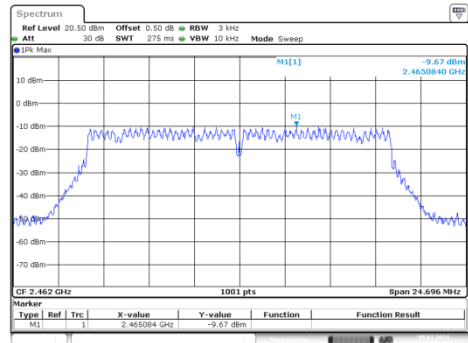

ProjectNo.:DG2231214-75516E-RF Tester:Jolojo Zhou
Date: 9-Jan-2024 18:26:22

n20_2412MHz

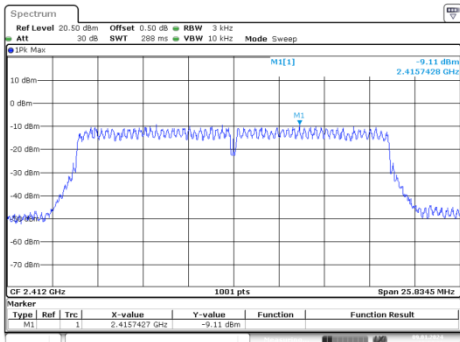

ProjectNo.:DG2231214-75516E-RF Tester:Jolojo Zhou
Date: 9-Jan-2024 15:14:29

n20_2437MHz

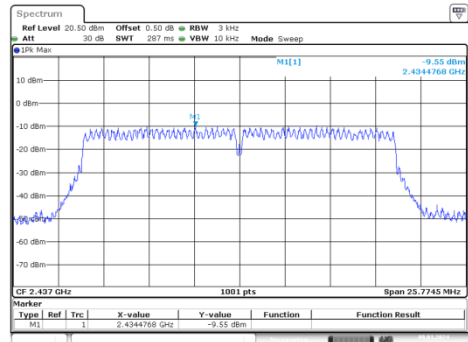

ProjectNo.:DG2231214-75516E-RF Tester:Jolojo Zhou
Date: 9-Jan-2024 15:22:34

n20_2462MHz

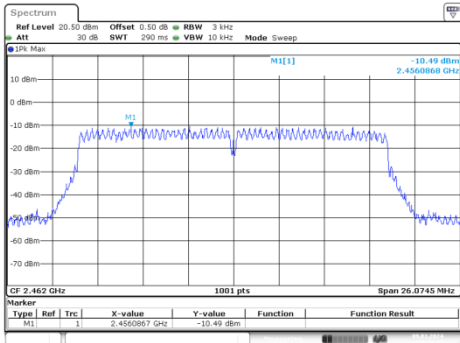

ProjectNo.:DG2231214-75516E-RF Tester:Jolojo Zhou
Date: 9-Jan-2024 15:29:05

5.7 100 kHz Bandwidth of Frequency Band Edge:

Serial No.:	2F7I-8	Test Date:	2024-01-09~2024-01-10
Test Site:	RF	Test Mode:	Transmitting
Tester:	Jojo Zhou	Test Result:	Pass

Environmental Conditions:

Temperature: (°C)	24.8~25.1	Relative Humidity: (%)	41~43	ATM Pressure: (kPa)	101.1~101.2
-----------------------------	-----------	----------------------------------	-------	-------------------------------	-------------

Test Equipment List and Details:

Manufacturer	Description	Model	Serial Number	Calibration Date	Calibration Due Date
R&S	Spectrum Analyzer	FSV40	101947	2023-10-18	2024-10-17
E-Microwave	Blocking Control	EMDCB-00036	OE01201047	2023-05-06	2024-05-05
yzjingcheng	Coaxial Cable	KTRFBU-141-50	41010012	2023-09-01	2024-08-31

* *Statement of Traceability: Bay Area Compliance Laboratories Corp. (Dongguan) attests that all calibrations have been performed, traceable to National Primary Standards and International System of Units (SI).*

Test Data:

Please refer to the following plots.

b_2412MHz

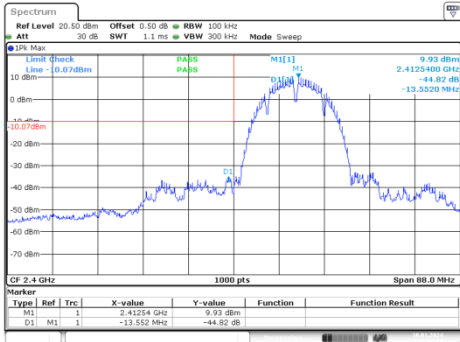

ProjectNo.:DG2231214-75516E-RF Testers:Jojo Zhou
Date: 10_JAN,2024 09:06:23

b_2462MHz

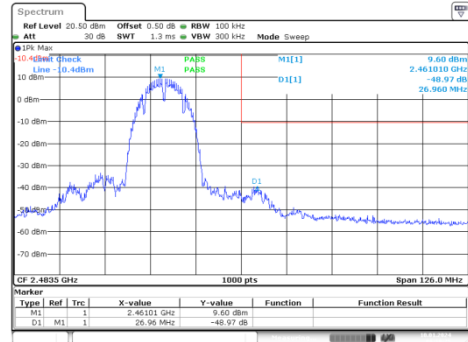

ProjectNo.:DG2231214-75516E-RF Testers:Jojo Zhou
Date: 10_JAN,2024 09:19:25

g_2412MHz

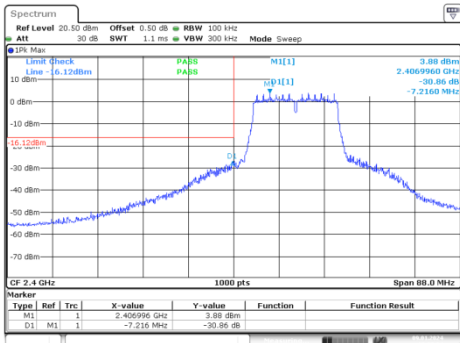

ProjectNo.:DG2231214-75516E-RF Testers:Jojo Zhou
Date: 9_JAN,2024 18:07:54

g_2462MHz

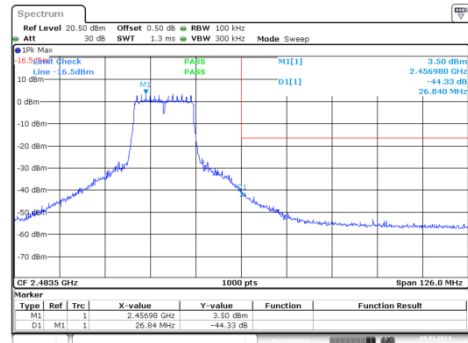

ProjectNo.:DG2231214-75516E-RF Testers:Jojo Zhou
Date: 9_JAN,2024 18:16:02

n20_2412MHz

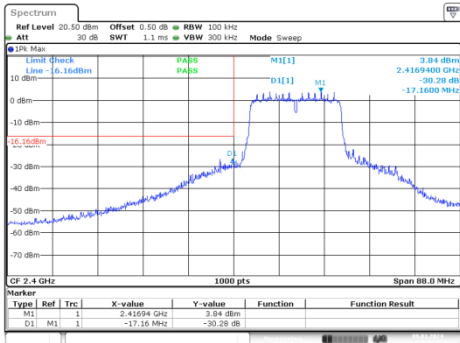

ProjectNo.:DG2231214-75516E-RF Testers:Jojo Zhou
Date: 9_JAN,2024 18:29:11

n20_2462MHz

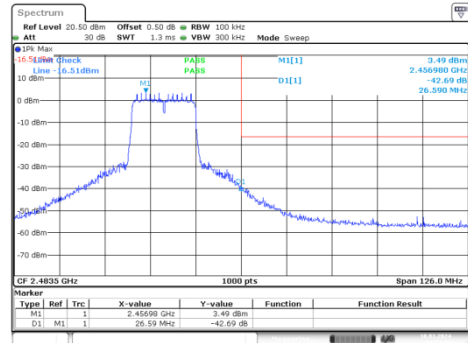

ProjectNo.:DG2231214-75516E-RF Testers:Jojo Zhou
Date: 10_JAN,2024 09:21:44

5.8 Duty Cycle:

Serial No.:	2F7I-8	Test Date:	2024-01-10
Test Site:	RF	Test Mode:	Transmitting
Tester:	Jojo Zhou	Test Result:	Pass

Environmental Conditions:

Temperature: (°C)	24.8	Relative Humidity: (%)	41	ATM Pressure: (kPa)	101.2
-----------------------------	------	----------------------------------	----	-------------------------------	-------

Test Equipment List and Details:

Manufacturer	Description	Model	Serial Number	Calibration Date	Calibration Due Date
R&S	Spectrum Analyzer	FSV40	101947	2023-10-18	2024-10-17
E-Microwave	Blocking Control	EMDCB-00036	OE01201047	2023-05-06	2024-05-05
yzjingcheng	Coaxial Cable	KTRFBU-141-50	41010012	2023-09-01	2024-08-31

* Statement of Traceability: Bay Area Compliance Laboratories Corp. (Dongguan) attests that all calibrations have been performed, traceable to National Primary Standards and International System of Units (SI).

Test Data:

Mode	Ton (ms)	Ton+Toff (ms)	Duty Cycle (%)	1/T (Hz)	VBW Setting (kHz)	Result
b_2437MHz_Chain 0	8.344	8.492	98.26	119.847	0.200	Pass
g_2437MHz_Chain 0	100.000	100.000	100.000	/	0.010	Pass
n20_2437MHz_Chain 0	100.000	100.000	100.000	/	0.010	Pass

Duty Cycle = Ton/(Ton+Toff)*100%

b_2437MHz_Chain 0

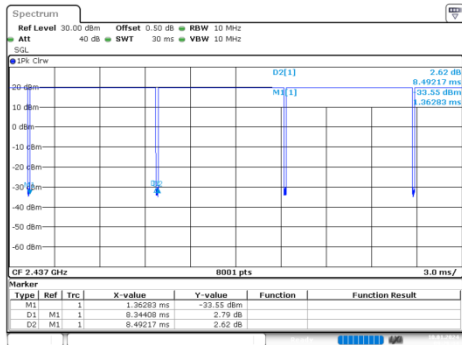

ProjectNo.:DG2231214-75516E-RF Testers:Jojo Zhou
Date: 10.JAN.2024 09:26:34

g_2437MHz_Chain 0

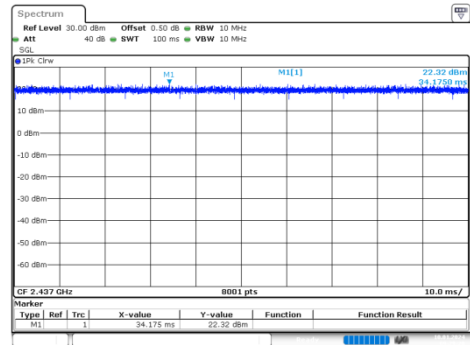

ProjectNo.:DG2231214-75516E-RF Testers:Jojo Zhou
Date: 10.JAN.2024 09:29:20

n20_2437MHz_Chain 0

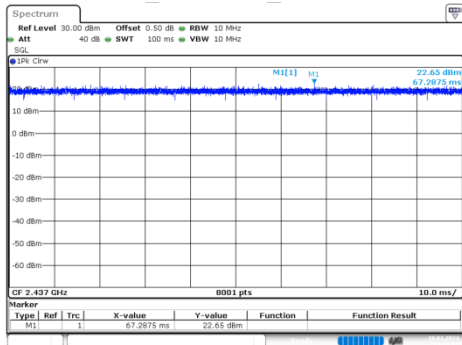

ProjectNo.:DG2231214-75516E-RF Testers:Jojo Zhou
Date: 10.JAN.2024 09:31:01

6. EUT PHOTOGRAPHS

Please refer to the attachment DG2231214-75516E-RF-EXP EUT EXTERNAL PHOTOGRAPHS and DG2231214-75516E-RF-INP EUT INTERNAL PHOTOGRAPHS.

7. TEST SETUP PHOTOGRAPHS

Please refer to the attachment DG2231214-75516E-RF-00B-TSP TEST SETUP PHOTOGRAPHS.

Appendix A. RF EXPOSURE EVALUATION

Applicable Standard

According to subpart 15.247(i) and subpart §1.1310, systems operating under the provisions of this section shall be operated in a manner that ensures that the public is not exposed to radio frequency energy level in excess of the Commission’s guidelines.

Limits for Maximum Permissible Exposure (MPE) (§1.1310, §2.1091)

(B) Limits for General Population/Uncontrolled Exposure				
Frequency Range (MHz)	Electric Field Strength (V/m)	Magnetic Field Strength (A/m)	Power Density (mW/cm²)	Averaging Time (minutes)
0.3–1.34	614	1.63	*(100)	30
1.34–30	824/f	2.19/f	*(180/f ²)	30
30–300	27.5	0.073	0.2	30
300–1500	/	/	f/1500	30
1500–100,000	/	/	1.0	30

f = frequency in MHz; * = Plane-wave equivalent power density;

According to §1.1310 and §2.1091 RF exposure is calculated.

Calculation formula:

Prediction of power density at the distance of the applicable MPE limit

$S = PG/4\pi R^2$ = power density (in appropriate units, e.g. mW/cm²);

P = power input to the antenna (in appropriate units, e.g., mW);

G = power gain of the antenna in the direction of interest relative to an isotropic radiator, the power gain factor, is normally numeric gain;

R = distance to the center of radiation of the antenna (appropriate units, e.g., cm);

Calculated Data:

Frequency (MHz)	Antenna Gain		Conducted output power including Tune-up Tolerance		Evaluation Distance (cm)	Power Density (mW/cm ²)	MPE Limit (mW/cm ²)
	(dBi)	(numeric)	(dBm)	(mW)			
2412-2462	3.18	2.08	24	251.19	20.00	0.10	1.0

The Conducted output power including Tune-up Tolerance provided by manufacturer

Result: The device meet FCC MPE at 20 cm distance

===== **END OF REPORT** =====