



# Shenzhen HTT Technology Co., Ltd.

## FCC PART 15 SUBPART C TEST REPORT FCC PART 15 SUBPART E 15.407

Report Reference No.....: **HTT202410082F02**

FCC ID.....: **2BEMH-N153S**

Compiled by  
( position+printed name+signature)..: File administrators

*Heber He*

Supervised by  
( position+printed name+signature)..: Project Engineer

*Bruce Zhan*

Approved by  
( position+printed name+signature)..: RF Manager

*Kevin Han*



Date of issue.....: Oct. 26, 2024

**Testing Laboratory Name .....: Shenzhen HTT Technology Co.,Ltd.**

Address.....: 1F, Building B, Huafeng International Robotics Industrial Park,  
Hangcheng Road,Nanchang Community, Xixiang Street, Bao'an  
District, Shenzhen, Guangdong, China

**Applicant's name .....: YEAHER INC.**

Address .....: 51 Steel Dr,Unit A, New Castle,Delaware,19720

**Test specification .....:**

Standard .....: **FCC Part 15 Subpart E 15.407**

**Shenzhen HTT Technology Co.,Ltd. All rights reserved.**

This publication may be reproduced in whole or in part for non-commercial purposes as long as the Shenzhen HTT Technology Co.,Ltd. is acknowledged as copyright owner and source of the material. Shenzhen HTT Technology Co.,Ltd. takes no responsibility for and will not assume liability for damages resulting from the reader's interpretation of the reproduced material due to its placement and context.

**Test item description .....: Portable Computer**

Trade Mark .....: N/A

Manufacturer .....: Nimo Direct Inc.

Model/Type reference.....: N153S

Listed Models .....: N153B, N153G

Modulation .....: OFDM

Frequency.....: From 5180MHz-5240MHz, 5745MHz-5825MHz

Ratings .....: DC 11.4V From Battery and DC 20.0V From External Circuit

Result.....: **PASS**

# TEST REPORT

Equipment under Test : Portable Computer

Model /Type : N153S

Serial Models : N153B, N153G

Applicant : YEAHER INC.

Model Declaration : PCB board, structure and internal of these model(s) are the same, So no additional models were tested.

Address : 51 Steel Dr,Unit A, New Castle,Delaware,19720

Manufacturer : Nimo Direct Inc.

Address : 51 Steel Dr,Unit A, New Castle,Delaware,19720

<b>Test Result:</b>	<b>PASS</b>
---------------------	-------------

The test report merely corresponds to the test sample.  
It is not permitted to copy extracts of these test result without the written permission of the test laboratory.

## Contents

<b><u>1</u></b>	<b><u>TEST STANDARDS .....</u></b>	<b><u>4</u></b>
<b><u>2</u></b>	<b><u>SUMMARY .....</u></b>	<b><u>5</u></b>
2.1	General Remarks	5
2.2	Product Description	5
2.3	Equipment Under Test	5
2.4	Short description of the Equipment under Test (EUT)	6
2.5	EUT operation mode	6
2.6	Block Diagram of Test Setup	6
2.7	Related Submittal(s) / Grant (s)	6
2.8	Modifications	6
<b><u>3</u></b>	<b><u>TEST ENVIRONMENT .....</u></b>	<b><u>7</u></b>
3.1	Address of the test laboratory	7
3.2	Test Facility	7
3.3	Environmental conditions	7
3.4	Test Description	8
3.5	Statement of the measurement uncertainty	8
3.6	Equipments Used during the Test	9
<b><u>4</u></b>	<b><u>TEST CONDITIONS AND RESULTS.....</u></b>	<b><u>10</u></b>
4.1	AC Power Conducted Emission	10
4.2	Radiated Emissions	13
4.3	Maximum Conducted Average Output Power	20
4.4	Power Spectral Density	22
4.5	Emission Bandwidth (26dB Bandwidth)	38
4.6	Minimum Emission Bandwidth (6dB Bandwidth)	42
4.7	Frequency Stability	46
<b><u>5</u></b>	<b><u>TEST SETUP PHOTOS OF THE EUT .....</u></b>	<b><u>52</u></b>
<b><u>6</u></b>	<b><u>PHOTOS OF THE EUT .....</u></b>	<b><u>52</u></b>

# 1 TEST STANDARDS

The tests were performed according to following standards:

[FCC Rules Part 15 Subpart E](#)—Unlicensed National Information Infrastructure Devices

[ANSI C63.10-2013](#): American National Standard for Testing Unlicensed Wireless Devices

[KDB789033 D02](#): General UNII Test Procedures New Rules v01r02

## 2 SUMMARY

### 2.1 General Remarks

Date of receipt of test sample	:	Oct. 18, 2024
Testing commenced on	:	Oct. 18, 2024
Testing concluded on	:	Oct. 26, 2024

### 2.2 Product Description

Product Description:	Portable Computer			
Model:	N153S			
Power Supply:	DC 11.4V From Battery and DC 20.0V From External Circuit			
Adapter Information:	Model: A879-200500C-US1 Input: 100-240V~50/60Hz,2.5A Output: PD 5V3A/9V3A/12V3A/15V3A/20V5A PPS 3.3-21V5A 100W Max			
testing sample ID:	HTT202410082-1# (Engineer sample), HTT202410082-2# (Normal sample)			
Hardware version:	V1.0			
Software version:	V1.0			
<b>WIFI</b>				
	20MHz system	40MHz system	80MHz system	160MHz system
Supported type:	802.11a 802.11n 802.11ac	802.11n 802.11ac	802.11ac	N/A
Operation frequency:	5180MHz-5240MHz 5745MHz-5825MHz	5190MHz-5230MHz 5755MHz-5795MHz	5210MHz 5775MHz	N/A
Modulation:	OFDM	OFDM	OFDM	N/A
Channel number:	9	4	2	N/A
Channel separation:	20MHz	40MHz	80MHz	N/A
Antenna Type:	FPC Antenna			
Antenna gain:	4.01dBi for 5180-5240MHz for ANT 1, 3.47dBi for 5745-5825MHz for ANT 1, 2.31dBi for 5180-5240MHz for ANT 2, 3.61dBi for 5745-5825MHz for ANT 2			

### 2.3 Equipment Under Test

#### Power supply system utilised

Power supply voltage	:	<input type="radio"/> 230V / 50 Hz	<input type="radio"/> 120V / 60Hz
		<input type="radio"/> 12 V DC	<input type="radio"/> 24 V DC
		<input checked="" type="radio"/> Other (specified in blank below)	

DC 11.4V From Battery and DC 20.0V From External Circuit

### 2.4 Short description of the Equipment under Test (EUT)

This is a Portable Computer.

For more details, refer to the user’s manual of the EUT.

### 2.5 EUT operation mode

The Applicant provides communication tools software (AT command) to control the EUT for staying in continuous transmitting (Duty Cycle more than 98%) and receiving mode for testing.

All test performed at the low, middle and high of operational frequency range of each mode.

Operation Frequency List WIFI on 5G Band:

Operating band	20MHz		40MHz		80MHz	
	Channel	Frequency (MHz)	Channel	Frequency (MHz)	Channel	Frequency (MHz)
U-NII 1 (5150MHz-5250MHz)	36	5180	38	5190	42	5210
	40	5200				
	44	5220	46	5230		
	48	5240				
U-NII 3 (5725MHz-5850MHz)	149	5745	151	5755	155	5775
	153	5765	159	5795		
	157	5785				
	161	5805				
	165	5825	--	--		

Note: The line display in grey is those Channels/Frequencies select to test in this report for each operation mode.

### 2.6 Block Diagram of Test Setup

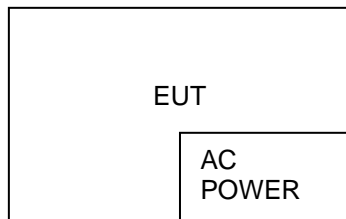

### 2.7 Related Submittal(s) / Grant (s)

This submittal(s) (test report) is intended to comply with Section 15.407 of the FCC Part 15, Subpart E Rules.

### 2.8 Modifications

No modifications were implemented to meet testing criteria.

### 3 TEST ENVIRONMENT

#### 3.1 Address of the test laboratory

**Shenzhen HTT Technology Co.,Ltd.**

1F, Building B, Huafeng International Robotics Industrial Park, Hangcheng Road, Nanchang Community, Xixiang Street, Bao'an District, Shenzhen, Guangdong, China

#### 3.2 Test Facility

The test facility is recognized, certified, or accredited by the following organizations:

**FCC-Registration No.: 779513 Designation Number: CN1319**

Shenzhen HTT Technology Co.,Ltd. has been listed on the US Federal Communications Commission list of test facilities recognized to perform electromagnetic emissions measurements.

**A2LA-Lab Cert. No.: 6435.01**

Shenzhen HTT Technology Co.,Ltd. has been listed by American Association for Laboratory Accreditation to perform electromagnetic emission measurement.

The 3m-Semi anechoic test site fulfils CISPR 16-1-4 according to ANSI C63.10 and CISPR 16-1-4:2010.

#### 3.3 Environmental conditions

During the measurement the environmental conditions were within the listed ranges:

Radiated Emission:

Temperature:	25 ° C
Humidity:	45 %
Atmospheric pressure:	950-1050mbar

Conducted testing:

Temperature:	25 ° C
Humidity:	44 %
Atmospheric pressure:	950-1050mbar

AC Power Conducted Emission

Temperature:	26 ° C
Humidity:	46 %
Atmospheric pressure:	950-1050mbar

### 3.4 Test Description

FCC Requirement		
FCC Part 15.207	AC Power Conducted Emission	PASS
FCC Part 15.407(a)	Emission Bandwidth(26dBm Bandwidth)	PASS <sup>Note1</sup>
FCC Part 15.407(e)	Minimum Emission Bandwidth(6dBm Bandwidth)	PASS <sup>Note2</sup>
FCC Part 15.407(a)	Maximum Conducted Output Power	PASS
FCC Part 15.407(a)	Peak Power Spectral Density	PASS
FCC Part 15.407(g)	Frequency Stability	PASS
FCC Part 15.407(b)	Undesirable emission	PASS
FCC Part 15.407(b)/15.205/15.209	Radiated Emissions	PASS
FCC Part 15.407(h)	Dynamic Frequency Selection	N/A <sup>Note 3</sup>
FCC Part 15.203/15.247(b)	Antenna Requirement	PASS

Note 1: Apply to U-NII 1 band.

Note 2: Apply to U-NII 3 band only.

Note 3: This device not work in DFS band.

#### Data Rate Used:

Preliminary tests were performed in different data rate to find the worst radiated emission. The data rate shown in the table below is the worst-case rate with respect to the specific test item. Investigation has been done on all the possible configurations for searching the worst cases. The following table is a list of the test modes shown in this test report.

Test Items	Mode	Data Rate
Maximum Conducted Output Power Power Spectral Density Emission Bandwidth(26dBm Bandwidth) Minimum Emission Bandwidth(6dBm Bandwidth) Undesirable emission Frequency Stability	11a/OFDM	6 Mbps
	11n(20MHz),11ac(20MHz)/OFDM	7.2 Mbps
	11n(40MHz),11ac(40MHz)/OFDM	15.0Mbps
	11ac(80MHz)/OFDM	65.0Mbps

### 3.5 Statement of the measurement uncertainty

The data and results referenced in this document are true and accurate. The reader is cautioned that there may be errors within the calibration limits of the equipment and facilities. The measurement uncertainty was calculated for all measurements listed in this test report acc. to TR-100028-01 "Electromagnetic compatibility and Radio spectrum Matters (ERM);Uncertainties in the measurement of mobile radio equipment characteristics; Part 1" and TR-100028-02 "Electromagnetic compatibility and Radio spectrum Matters (ERM);Uncertainties in the measurement of mobile radio equipment characteristics; Part 2 " and is documented in the Shenzhen HTT Technology Co.,Ltd. quality system acc. to DIN EN ISO/IEC 17025. Furthermore, component and process variability of devices similar to that tested may result in additional deviation. The manufacturer has the sole responsibility of continued compliance of the device.

Hereafter the best measurement capability for Shenzhen HTT Technology Co.,Ltd.:

Test	Range	Measurement Uncertainty	Notes
Radiated Emission	30~1000MHz	4.37 dB	(1)
Radiated Emission	1~18GHz	5.40 dB	(1)
Radiated Emission	18-40GHz	5.45 dB	(1)



Conducted Disturbance	0.15~30MHz	2.68 dB	(1)
-----------------------	------------	---------	-----

(1) This uncertainty represents an expanded uncertainty expressed at approximately the 95% confidence level using a coverage factor of k=2.

### 3.6 Equipments Used during the Test

Item	Test Equipment	Manufacturer	Model No.	Inventory No.	Cal.Date (mm-dd-yy)	Cal.Due date (mm-dd-yy)
1	3m Semi- Anechoic Chamber	Shenzhen C.R.T technology co., LTD	9*6*6	HTT-E028	Aug. 10 2024	Aug. 09 2027
2	Control Room	Shenzhen C.R.T technology co., LTD	4.8*3.5*3.0	HTT-E030	Aug. 10 2024	Aug. 09 2027
3	EMI Test Receiver	Rohde&Schwar	ESCI7	HTT-E022	Apr. 26 2024	Apr. 25 2025
4	Spectrum Analyzer	Rohde&Schwar	FSP	HTT-E037	Apr. 26 2024	Apr. 25 2025
5	Coaxial Cable	ZDecl	ZT26-NJ-NJ-0.6M	HTT-E018	Apr. 26 2024	Apr. 25 2025
6	Coaxial Cable	ZDecl	ZT26-NJ-SMAJ-2M	HTT-E019	Apr. 26 2024	Apr. 25 2025
7	Coaxial Cable	ZDecl	ZT26-NJ-SMAJ-0.6M	HTT-E020	Apr. 26 2024	Apr. 25 2025
8	Coaxial Cable	ZDecl	ZT26-NJ-SMAJ-8.5M	HTT-E021	Apr. 26 2024	Apr. 25 2025
9	Composite logarithmic antenna	Schwarzbeck	VULB 9168	HTT-E017	May. 21 2024	May. 20 2025
10	Horn Antenna	Schwarzbeck	BBHA9120D	HTT-E016	May. 20 2024	May. 19 2025
11	Loop Antenna	Zhinan	ZN30900C	HTT-E039	Apr. 26 2024	Apr. 25 2025
12	Horn Antenna	Beijing Hangwei Dayang	OBH100400	HTT-E040	Apr. 26 2024	Apr. 25 2025
13	low frequency Amplifier	Sonoma Instrument	310	HTT-E015	Apr. 26 2024	Apr. 25 2025
14	high-frequency Amplifier	HP	8449B	HTT-E014	Apr. 26 2024	Apr. 25 2025
15	Variable frequency power supply	Shenzhen Anbiao Instrument Co., Ltd	ANB-10VA	HTT-082	Apr. 26 2024	Apr. 25 2025
16	EMI Test Receiver	Rohde & Schwarz	ESCS30	HTT-E004	Apr. 26 2024	Apr. 25 2025
17	Artificial Mains	Rohde & Schwarz	ESH3-Z5	HTT-E006	May. 23 2024	May. 22 2025
18	Artificial Mains	Rohde & Schwarz	ENV-216	HTT-E038	May. 23 2024	May. 22 2025
19	Cable Line	Robinson	Z302S-NJ-BNCJ-1.5M	HTT-E001	Apr. 26 2024	Apr. 25 2025
20	Attenuator	Robinson	6810.17A	HTT-E007	Apr. 26 2024	Apr. 25 2025
21	Variable frequency power supply	Shenzhen Yanghong Electric Co., Ltd	YF-650 (5KVA)	HTT-E032	Apr. 26 2024	Apr. 25 2025
22	Control Room	Shenzhen C.R.T technology co., LTD	8*4*3.5	HTT-E029	Aug. 10 2024	Aug. 09 2027
23	DC power supply	Agilent	E3632A	HTT-E023	Apr. 26 2024	Apr. 25 2025
24	EMI Test Receiver	Agilent	N9020A	HTT-E024	Apr. 26 2024	Apr. 25 2025
25	Analog signal generator	Agilent	N5181A	HTT-E025	Apr. 26 2024	Apr. 25 2025
26	Vector signal generator	Agilent	N5182A	HTT-E026	Apr. 26 2024	Apr. 25 2025
27	Power sensor	Keysight	U2021XA	HTT-E027	Apr. 26 2024	Apr. 25 2025
28	Temperature and humidity meter	Shenzhen Anbiao Instrument Co., Ltd	TH10R	HTT-074	Apr. 28 2024	Apr. 27 2025
29	Radiated Emission Test Software	Farad	EZ-EMC	N/A	N/A	N/A
30	Conducted Emission Test Software	Farad	EZ-EMC	N/A	N/A	N/A
31	RF Test Software	panshanrf	TST	N/A	N/A	N/A

## 4 TEST CONDITIONS AND RESULTS

### 4.1 AC Power Conducted Emission

#### TEST CONFIGURATION

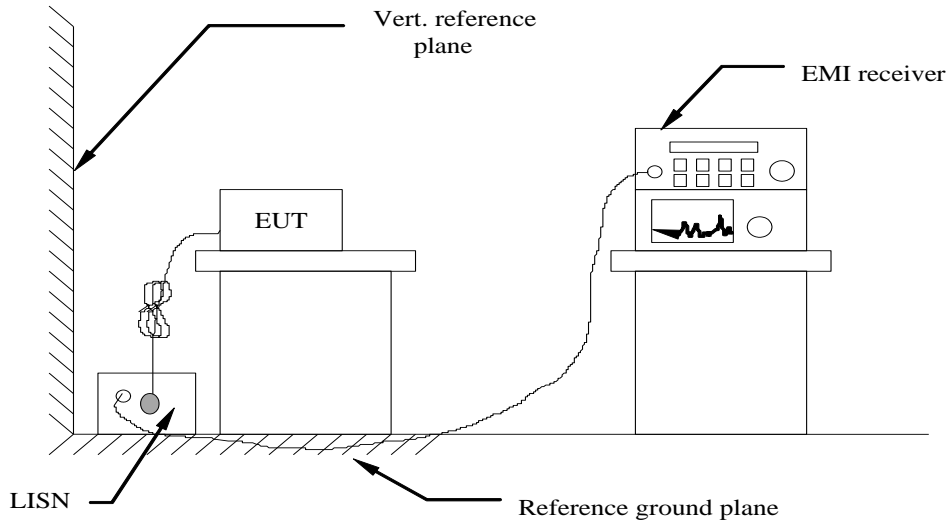

#### TEST PROCEDURE

- 1 The equipment was set up as per the test configuration to simulate typical actual usage per the user's manual. The EUT is a tabletop system, a wooden table with a height of 0.8 meters is used and is placed on the ground plane as per ANSI C63.10-2013.
- 2 Support equipment, if needed, was placed as per ANSI C63.10-2013
- 3 All I/O cables were positioned to simulate typical actual usage as per ANSI C63.10-2013
- 4 The EUT received power from adapter, the adapter received AC120V/60Hz and AC 240V/60Hz power through a Line Impedance Stabilization Network (LISN) which supplied power source and was grounded to the ground plane.
- 5 All support equipments received AC power from a second LISN, if any.
- 6 The EUT test program was started. Emissions were measured on each current carrying line of the EUT using a spectrum Analyzer / Receiver connected to the LISN powering the EUT. The LISN has two monitoring points: Line 1 (Hot Side) and Line 2 (Neutral Side). Two scans were taken: one with Line 1 connected to Analyzer / Receiver and Line 2 connected to a 50 ohm load; the second scan had Line 1 connected to a 50 ohm load and Line 2 connected to the Analyzer / Receiver.
- 7 Analyzer / Receiver scanned from 150 KHz to 30MHz for emissions in each of the test modes.
- 8 During the above scans, the emissions were maximized by cable manipulation.

#### AC Power Conducted Emission Limit

For intentional device, according to § 15.207(a) AC Power Conducted Emission Limits is as following :

Frequency range (MHz)	Limit (dBuV)	
	Quasi-peak	Average
0.15-0.5	66 to 56*	56 to 46*
0.5-5	56	46
5-30	60	50

\* Decreases with the logarithm of the frequency.

**TEST RESULTS**

Remark:

1. All modes of 802.11a/n/ac were tested at Low, Middle, and High channel; only the worst result of 802.11a CH36 was reported as below:
2. Both 120 VAC, 50/60 Hz and 240 VAC, 50/60 Hz power supply have been tested, only the worst result of 120 VAC, 60 Hz was reported as below:

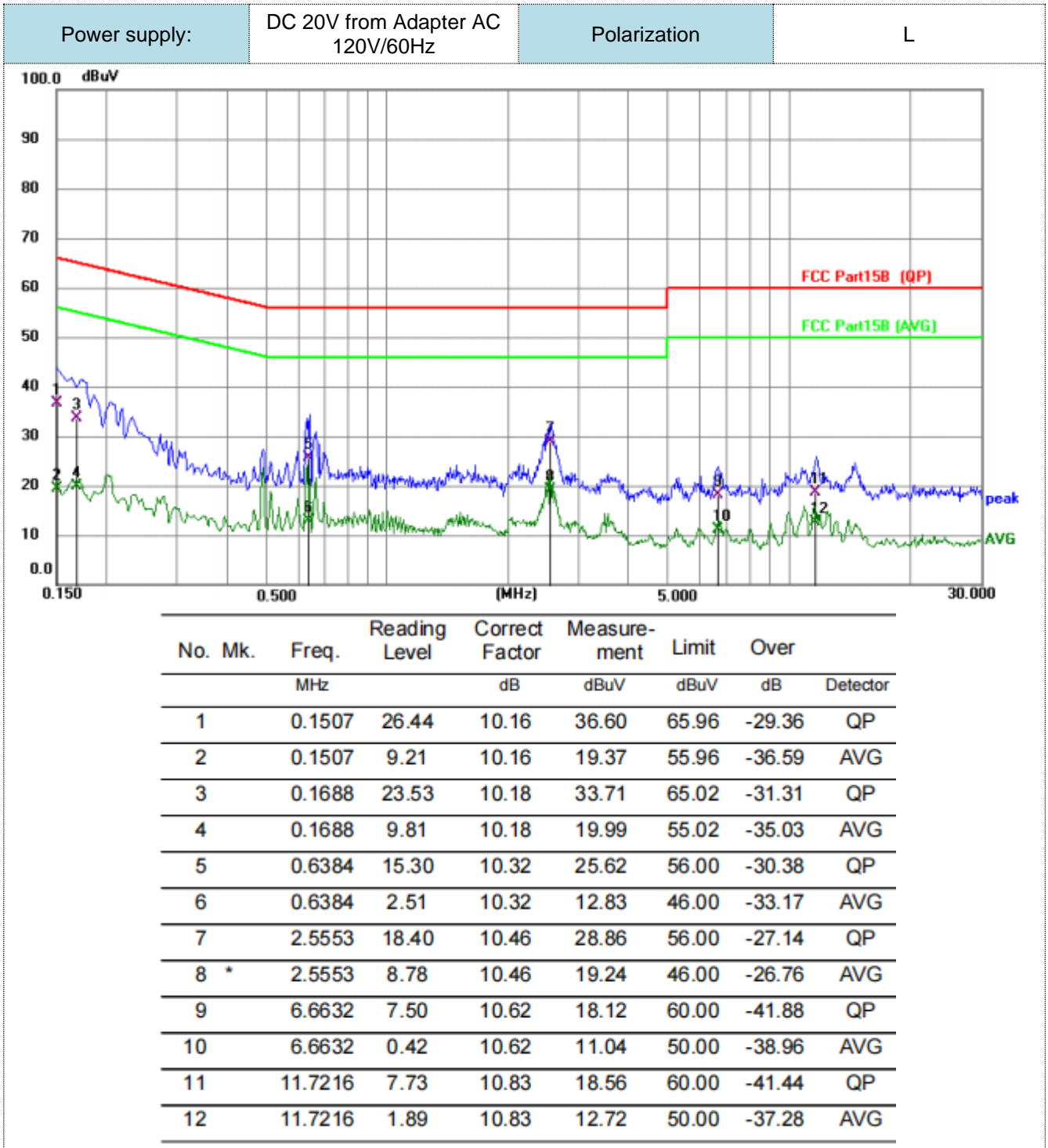

Power supply:	DC 20V from Adapter AC 120V/60Hz	Polarization	N
---------------	----------------------------------	--------------	---

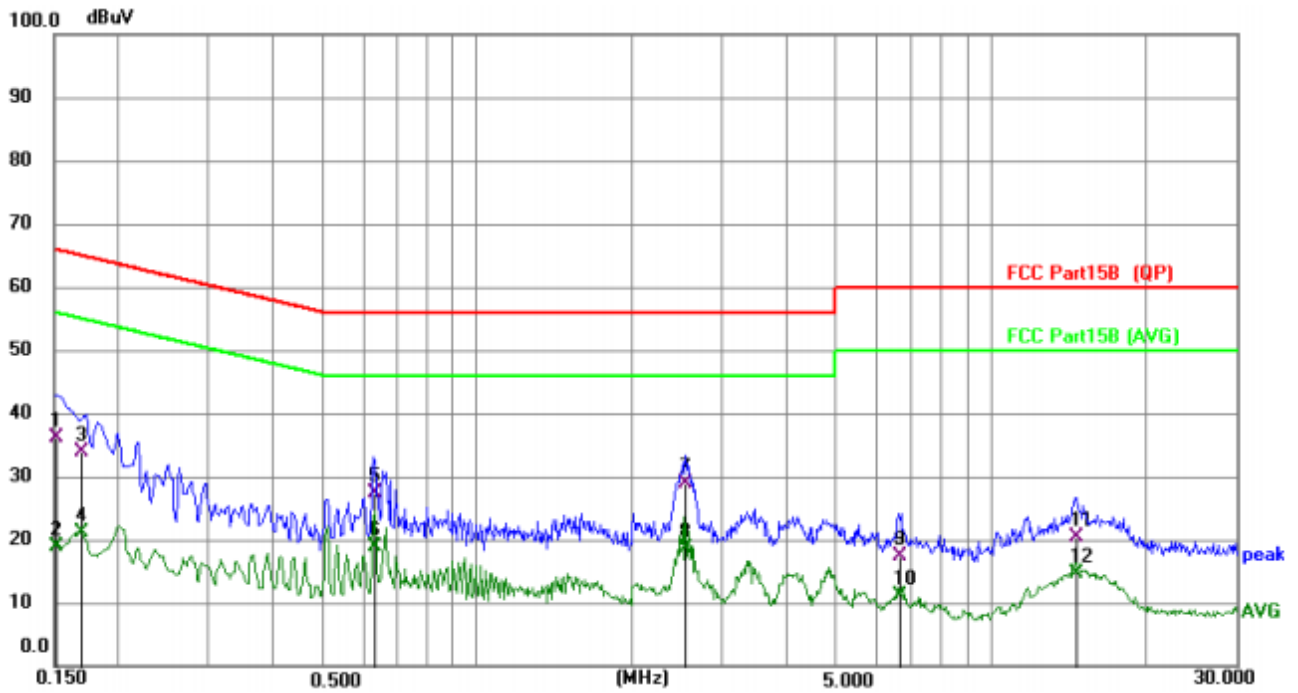

No.	Mk.	Freq. MHz	Reading Level	Correct Factor	Measurement	Limit	Over	Detector
					dBuV	dBuV	dB	
1		0.1516	26.00	10.16	36.16	65.91	-29.75	QP
2		0.1516	8.61	10.16	18.77	55.91	-37.14	AVG
3		0.1694	23.69	10.18	33.87	64.99	-31.12	QP
4		0.1694	10.85	10.18	21.03	54.99	-33.96	AVG
5		0.6344	17.15	10.35	27.50	56.00	-28.50	QP
6	*	0.6344	8.60	10.35	18.95	46.00	-27.05	AVG
7		2.5567	18.38	10.43	28.81	56.00	-27.19	QP
8		2.5567	8.24	10.43	18.67	46.00	-27.33	AVG
9		6.6745	6.79	10.67	17.46	60.00	-42.54	QP
10		6.6745	0.56	10.67	11.23	50.00	-38.77	AVG
11		14.7167	9.15	11.15	20.30	60.00	-39.70	QP
12		14.7167	3.58	11.15	14.73	50.00	-35.27	AVG

Notes:

1. An initial pre-scan was performed on the line and neutral lines with peak detector.
2. Quasi-Peak and Average measurement were performed at the frequencies with maximized peak emission.
3. Final Level =Receiver Read level + LISN Factor + Cable Los

## 4.2 Radiated Emissions

### Limit

The maximum emissions outside of the frequency bands of operation shall be attenuated in accordance with the following limits:

- (1) For transmitters operating in the 5.15-5.25 GHz band: All emissions outside of the 5.15-5.35 GHz band shall not exceed an e.i.r.p. of -27 dBm/MHz.
- (2) For transmitters operating in the 5.25-5.35 GHz band: All emissions outside of the 5.15-5.35 GHz band shall not exceed an e.i.r.p. of -27 dBm/MHz.
- (3) For transmitters operating in the 5.47-5.725 GHz band: All emissions outside of the 5.47-5.725 GHz band shall not exceed an e.i.r.p. of -27 dBm/MHz.
- (4) For transmitters operating in the 5.725-5.85 GHz band: All emissions shall be limited to a level of -27 dBm/MHz at 75 MHz or more above or below the band edge increasing linearly to 10 dBm/MHz at 25 MHz above or below the band edge, and from 25 MHz above or below the band edge increasing linearly to a level of 15.6 dBm/MHz at 5 MHz above or below the band edge, and from 5 MHz above or below the band edge increasing linearly to a level of 27 dBm/MHz at the band edge.

#### Undesirable emission limits

Requirement	Limit(EIRP)	Limit (Field strength at 3m) <small>Note1</small>
15.407(b)(1)	PK:-27(dBm/MHz)	PK:68.2(dBμV/m)
15.407(b)(2)		
15.407(b)(3)		
15.407(b)(4)		

Note1: The following formula is used to convert the equipment isotropic radiated power (eirp) to field strength:

$$E = \frac{1000000\sqrt{30P}}{3} \mu\text{V/m, where P is the eirp (Watts)}$$

- (5) Unwanted emissions below 1 GHz must comply with the general field strength limits set forth in §15.209
- (6) In addition, radiated emissions which fall in the restricted bands, as defined in §15.205(a), must also comply with the radiated emission limits specified in §15.209(a)

#### Radiated emission limits

Frequency (MHz)	Distance (Meters)	Radiated (dBμV/m)	Radiated (μV/m)
0.009-0.49	3	20log(2400/F(KHz))+40log(300/3)	2400/F(KHz)
0.49-1.705	3	20log(24000/F(KHz))+ 40log(30/3)	24000/F(KHz)
1.705-30	3	20log(30)+ 40log(30/3)	30
30-88	3	40.0	100
88-216	3	43.5	150
216-960	3	46.0	200
Above 960	3	54.0	500

**TEST CONFIGURATION**

(A) Radiated Emission Test Set-Up, Frequency Below 30MHz

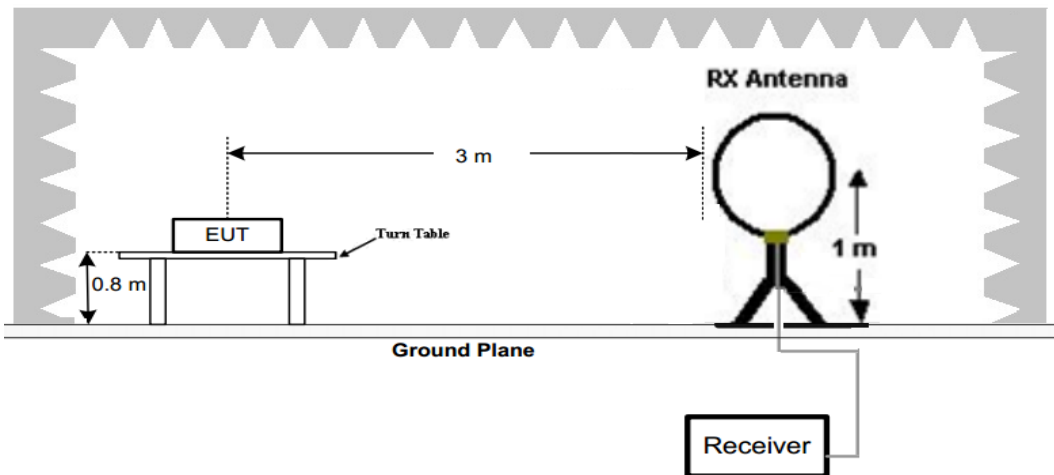

(B) Radiated Emission Test Set-Up, Frequency below 1000MHz

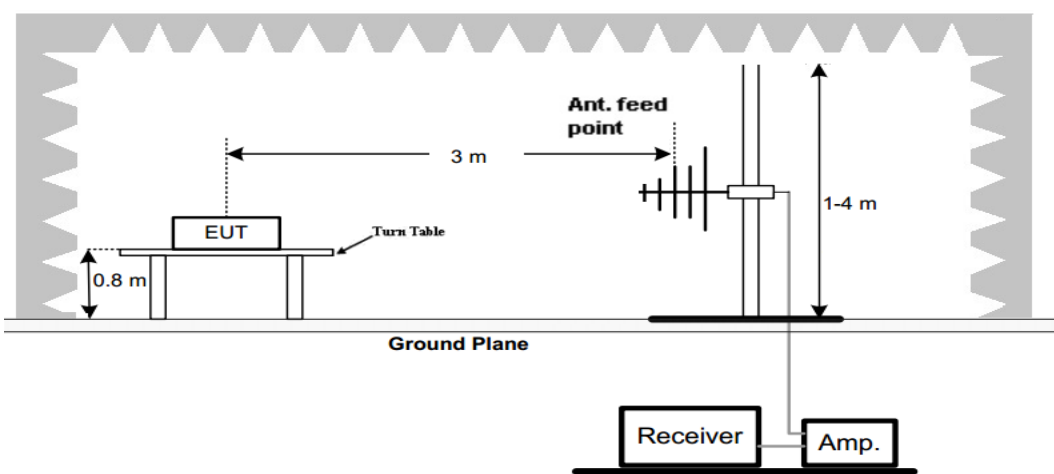

(C) Radiated Emission Test Set-Up, Frequency above 1000MHz

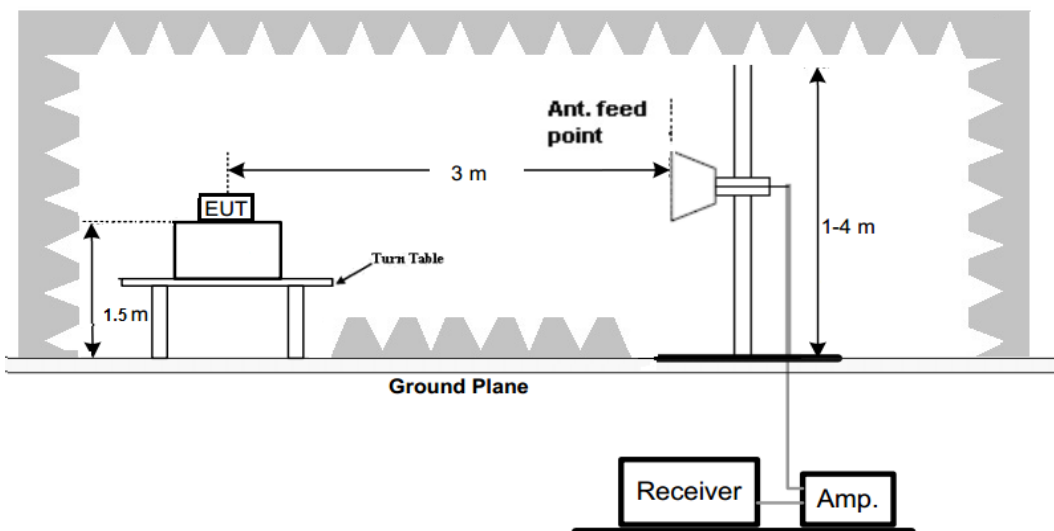

**Test Procedure**

1. Below 1GHz measurement the EUT is placed on a turntable which is 0.8m above ground plane, and above 1GHz measurement EUT was placed on a low permittivity and low loss tangent turn table which is 1.5m above ground plane.
2. Maximum procedure was performed by raising the receiving antenna from 1m to 4m and rotating the turn table from 0°C to 360°C to acquire the highest emissions from EUT
3. And also, each emission was to be maximized by changing the polarization of receiving antenna both horizontal and vertical.
4. Repeat above procedures until all frequency measurements have been completed.
5. Radiated emission test frequency band from 9KHz to 40GHz.
6. The distance between test antenna and EUT as following table states:

Test Frequency range	Test Antenna Type	Test Distance
9KHz-30MHz	Active Loop Antenna	3
30MHz-1GHz	Bilog Antenna	3
1GHz-18GHz	Horn Antenna	3
18GHz-25GHz	Horn Antenna	1

7. Setting test receiver/spectrum as following table states:

Test Frequency range	Test Receiver/Spectrum Setting	Detector
9KHz-150KHz	RBW=200Hz/VBW=3KHz,Sweep time=Auto	QP
150KHz-30MHz	RBW=9KHz/VBW=100KHz,Sweep time=Auto	QP
30MHz-1GHz	RBW=120KHz/VBW=1000KHz,Sweep time=Auto	QP
1GHz-40GHz	Peak Value: RBW=1MHz/VBW=3MHz, Sweep time=Auto Average Value: RBW=1MHz/VBW=10Hz, Sweep time=Auto	Peak

**TEST RESULTS**

Remark:

1. This test was performed with EUT in X, Y, Z position and the worse case was found when EUT in X position.
1. All 802.11a/n/ac modes have been tested for below 1GHz test, only the worst case 802.11a low channel of U-NII 1 band was recorded.
2. All 802.11a/n/ac modes have been tested for above 1GHz test, only the worst case 802.11a was recorded.
3. Radiated emission test from 9 KHz to 10th harmonic of fundamental was verified, and no emission found except system noise floor in 9 KHz to 30MHz and not recorded in this report.

For 30MHz-1GHz

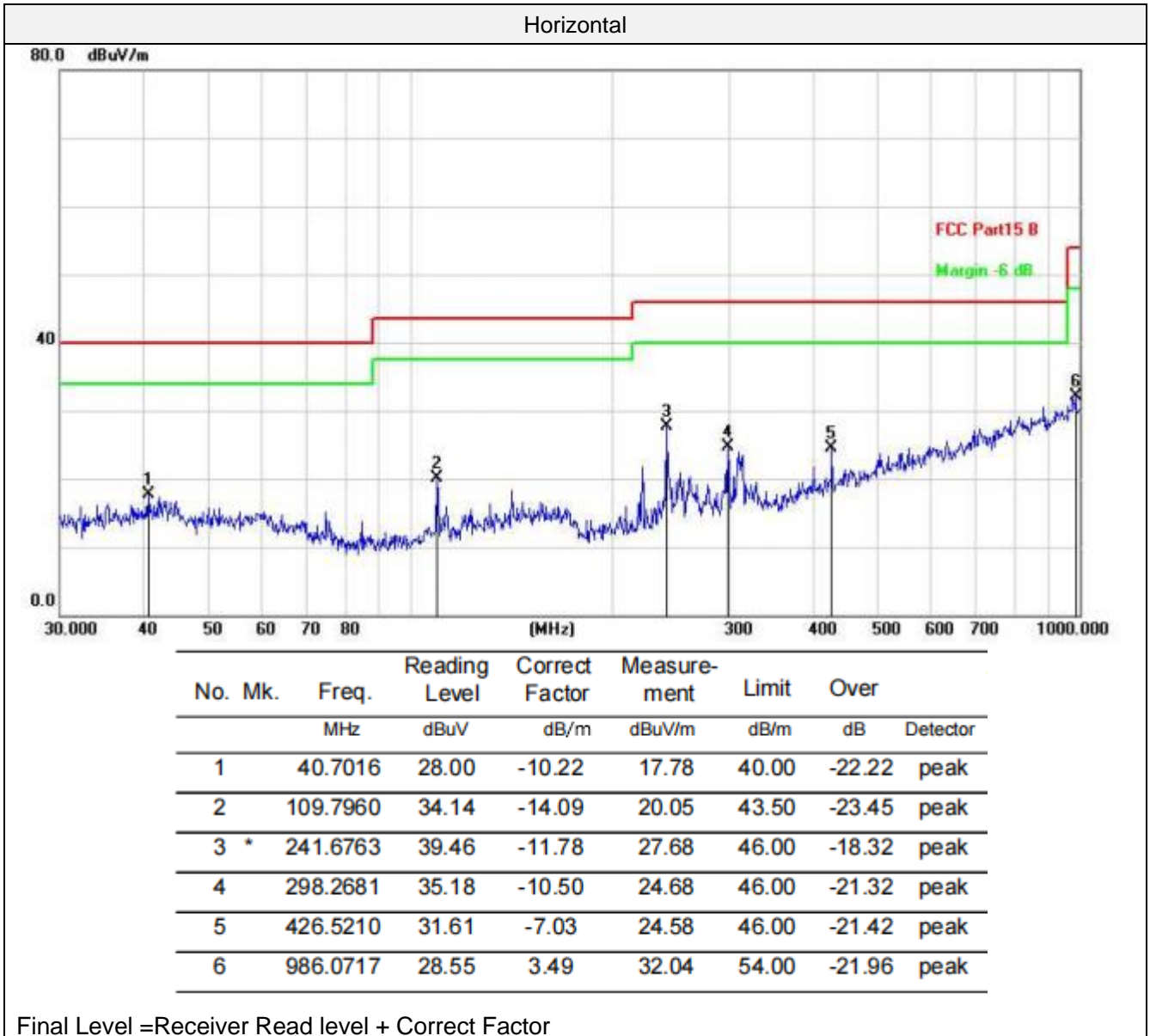



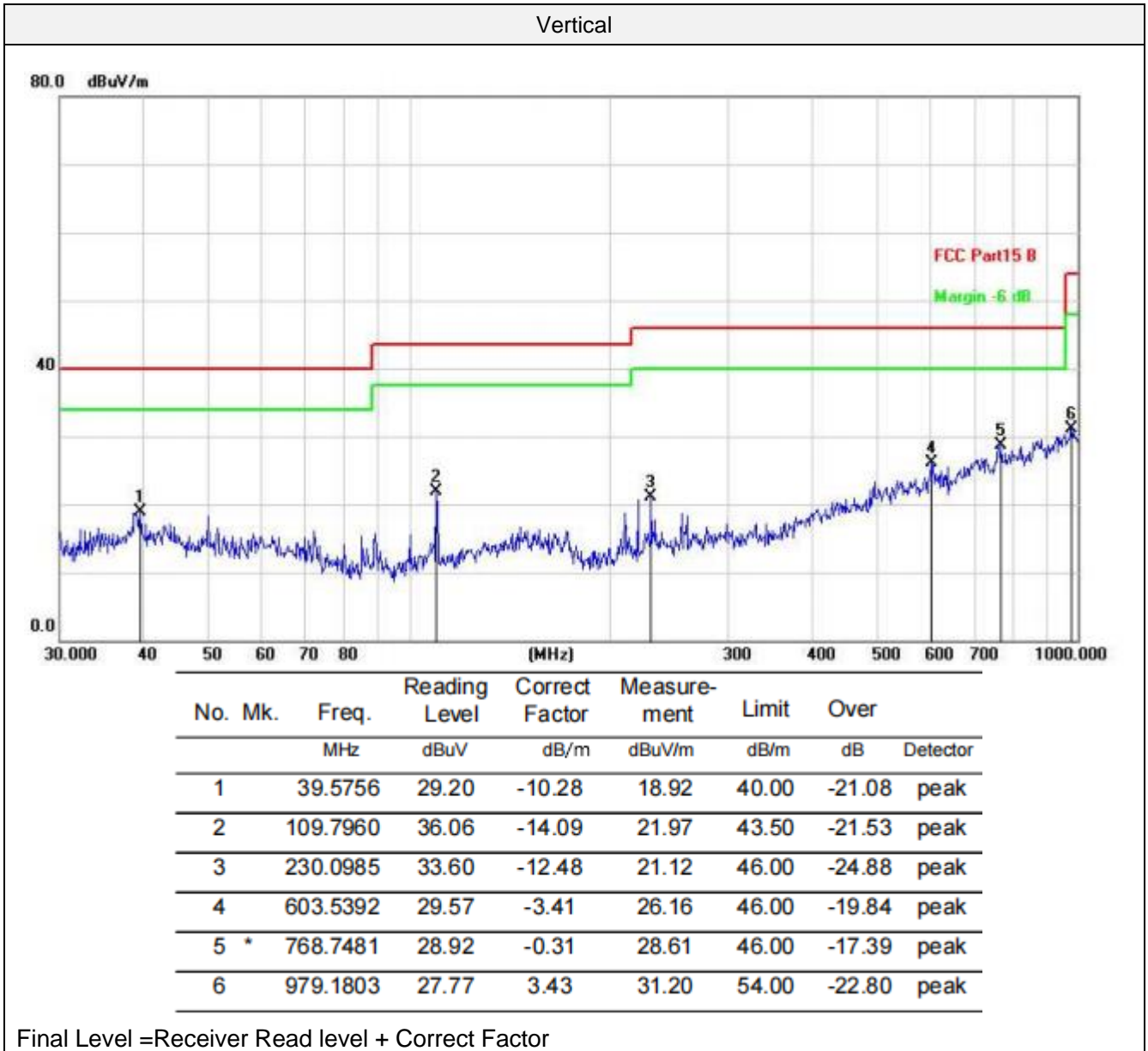

**For 1GHz to 40GHz**

Note: All 802.11a / 802.11n/ac (HT20) /802.11n/ac (HT40)/ 802.11ac (HT80) modes have been tested for above 1GHz test, only the worst case 802.11a was recorded.

**U-NII 1 & 802.11a Mode (above 1GHz)**

Tested Channel	Frequency (MHz)	Emission Level (dBuV/m)	Detector Mode	ANT Pol	Limit (dBuV/m)	Margin (dB)	Raw Value (dBuV)	Antenna Factor (dB/m)	Cable Factor (dB)	Pre amplifier (dB)	Correction Factor (dB/m)
36.00 (5180MHz)	5150.00	56.27	PK	H	68.20	11.93	47.60	32.8	6.97	31.1	8.67
	5150.00	49.35	AV	H	54.00	4.65	40.68	32.8	6.97	31.1	8.67
	10360.00	53.47	PK	H	68.20	14.73	38.83	38.6	10.05	29.9	18.75
	--	--	--	--	--	--	--	--	--	--	--
40.00 (5200MHz)	10400.00	53.41	PK	H	68.20	14.79	35.06	38.2	10.05	29.9	18.35
	--	--	--	--	--	--	--	--	--	--	--
48.00 (5240MHz)	5350.50	50.33	PK	H	68.20	17.87	40.66	33.2	7.47	31	9.67
	10480.00	52.18	PK	H	68.20	16.02	33.34	38.9	10.04	30.1	18.84
	--	--	--	--	--	--	--	--	--	--	--

Tested Channel	Frequency (MHz)	Emission Level (dBuV/m)	Detector Mode	ANT Pol	Limit (dBuV/m)	Margin (dB)	Raw Value (dBuV)	Antenna Factor (dB/m)	Cable Factor (dB)	Pre amplifier (dB)	Correction Factor (dB/m)
36.00 (5180MHz)	5150.00	57.18	PK	V	68.20	11.02	48.51	32.8	6.97	31.1	8.67
	5150.00	49.45	AV	V	54.00	4.55	40.78	32.8	6.97	31.1	8.67
	10360.00	53.22	PK	V	68.20	14.98	34.47	38.6	10.05	29.9	18.75
	--	--	--	--	--	--	--	--	--	--	--
40.00 (5200MHz)	10400.00	52.96	PK	V	68.20	15.24	34.61	38.2	10.05	29.9	18.35
	--	--	--	--	--	--	--	--	--	--	--
48.00 (5240MHz)	5350.50	52.78	PK	V	68.20	15.42	43.11	33.2	7.47	31	9.67
	10480.00	52.98	PK	V	68.20	15.22	34.14	38.9	10.04	30.1	18.84
	--	--	--	--	--	--	--	--	--	--	--

**U-NII 3 & 802.11a Mode (above 1GHz)**

Tested Channel	Frequency (MHz)	Emission Level (dBuV/m)	Detector Mode	ANT Pol	Limit (dBuV/m)	Margin (dB)	Raw Value (dBuV)	Antenna Factor (dB/m)	Cable Factor (dB)	Pre amplifier (dB)	Correction Factor (dB/m)
	5720.00	53.09	PK	H	68.20	15.11	43.72	33	7.47	31.1	9.37
149.00 (5745MHz)	5720.00	47.49	AV	H	54.00	6.51	38.12	33	7.47	31.1	9.37
	11490.00	53.96	PK	H	68.20	14.24	34.24	39.8	10.62	30.7	19.72
	--	--	--	--	--	--	--	--	--	--	--
157.00 (5785MHz)	11570.00	53.42	PK	H	68.20	14.78	33.90	39.6	10.62	30.7	19.52
	--	--	--	--	--	--	--	--	--	--	--
48.00 (5825MHz)	5855.00	52.69	PK	H	68.20	15.51	42.18	33.91	7.7	31.1	10.51
	11650.00	53.55	PK	H	68.20	14.65	33.93	39.6	10.62	30.6	19.62
	--	--	--	--	--	--	--	--	--	--	--

Tested Channel	Frequency (MHz)	Emission Level (dBuV/m)	Detector Mode	ANT Pol	Limit (dBuV/m)	Margin (dB)	Raw Value (dBuV)	Antenna Factor (dB/m)	Cable Factor (dB)	Pre amplifier (dB)	Correction Factor (dB/m)
	5720.00	53.79	PK	V	68.20	14.41	44.42	33	7.47	31.1	9.37
149.00 (5745MHz)	5720.00	48.45	AV	V	54.00	5.55	39.08	33	7.47	31.1	9.37
	11490.00	51.89	PK	V	68.20	16.31	32.17	39.8	10.62	30.7	19.72
	--	--	--	--	--	--	--	--	--	--	--
157.00 (5785MHz)	11570.00	52.36	PK	V	68.20	15.84	32.84	39.6	10.62	30.7	19.52
	--	--	--	--	--	--	--	--	--	--	--
48.00 (5825MHz)	5855.00	53.49	PK	V	68.20	14.71	42.98	33.91	7.7	31.1	10.51
	11650.00	52.76	PK	V	68.20	15.44	33.14	39.6	10.62	30.6	19.62
	--	--	--	--	--	--	--	--	--	--	--

## REMARKS:

1. Emission level (dBuV/m) =Raw Value (dBuV)+Correction Factor (dB/m)
2. Correction Factor (dB/m) = Antenna Factor (dB/m)+Cable Factor (dB)-Pre-amplifier Factor
3. Margin value = Limit value- Emission level.
4. -- Mean the other emission levels were very low against the limit.
5. RBW1MHz VBW3MHz Peak detector is for PK value; RBW 1MHz VBW10Hz Peak detector is for AV value.
6. Worst case data at 6Mbps at IEEE 802.11a; MCS0 at IEEE 802.11n HT20, IEEE 802.11n HT40, IEEE 802.11ac VHT20 ,IEEE 802.11ac VHT40 and IEEE 802.11ac VHT80;

### 4.3 Maximum Conducted Average Output Power

#### Limit

##### **For the band 5.15-5.25 GHz.**

(i) For an outdoor access point operating in the band 5.15-5.25 GHz, the maximum conducted output power over the frequency band of operation shall not exceed 1 W provided the maximum antenna gain does not exceed 6 dBi.

(ii) For an indoor access point operating in the band 5.15-5.25 GHz, the maximum conducted output power over the frequency band of operation shall not exceed 1 W provided the maximum antenna gain does not exceed 6 dBi.

(iii) For fixed point-to-point access points operating in the band 5.15-5.25 GHz, the maximum conducted output power over the frequency band of operation shall not exceed 1 W.

(iv) For client devices in the 5.15-5.25 GHz band, the maximum conducted output power over the frequency band of operation shall not exceed 250 mW provided the maximum antenna gain does not exceed 6 dBi.

**For the 5.25-5.35 GHz and 5.47-5.725 GHz bands**, the maximum conducted output power over the frequency bands of operation shall not exceed the lesser of 250 mW or  $11 \text{ dBm} + 10 \log B$ , where B is the 26 dB emission bandwidth in megahertz.

**For the band 5.725-5.85 GHz**, the maximum conducted output power over the frequency band of operation shall not exceed 1 W

#### Test Procedure

Remove the antenna from the EUT and then connect a low loss RF cable from the antenna port to the power sensor.

#### Test Configuration

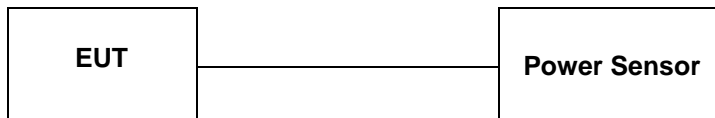

## Test Results

Mode	TX Type	Frequency (MHz)	Maximum Average Conducted Output Power (dBm)				Verdict
			ANT1	ANT2	MIMO	Limit	
802.11a	SISO	5180	4.39	2.97	/	<=24.0	Pass
		5200	5.22	3.49	/	<=24.0	Pass
		5240	5.03	3.08	/	<=24.0	Pass
		5745	2.06	1.53	/	<=30	Pass
		5785	3.08	1.61	/	<=30	Pass
		5825	2.34	0.42	/	<=30	Pass
802.11n (HT20)	MIMO	5180	3.48	1.84	5.75	<=23.75	Pass
		5200	3.53	1.82	5.77	<=23.75	Pass
		5240	2.97	1.67	5.38	<=23.75	Pass
		5745	1.74	0.31	4.09	<=29.45	Pass
		5785	2.12	0.45	4.38	<=29.45	Pass
		5825	0.47	-0.15	3.18	<=29.45	Pass
802.11n (HT40)	MIMO	5190	3.77	2.03	6.00	<=23.75	Pass
		5230	3.30	1.71	5.59	<=23.75	Pass
		5755	2.18	1.41	4.82	<=29.45	Pass
		5795	3.05	1.48	5.35	<=29.45	Pass
802.11ac (VHT20)	MIMO	5180	3.55	1.85	5.79	<=23.75	Pass
		5200	3.45	1.82	5.72	<=23.75	Pass
		5240	3.97	1.49	5.91	<=23.75	Pass
		5745	1.71	0.19	4.03	<=29.45	Pass
		5785	2.07	0.32	4.29	<=29.45	Pass
		5825	0.50	-0.48	3.05	<=29.45	Pass
802.11ac (VHT40)	MIMO	5190	3.69	2.01	5.94	<=23.75	Pass
		5230	3.02	1.51	5.34	<=23.75	Pass
		5755	2.18	1.27	4.76	<=29.45	Pass
		5795	3.06	1.28	5.27	<=29.45	Pass
802.11ac (VHT80)	MIMO	5210	4.43	5.45	7.98	<=23.75	Pass
		5775	3.15	1.46	5.40	<=29.45	Pass

## 4.4 Power Spectral Density

### Limit

(1) For the band 5.15 - 5.25 GHz.

(i) For an outdoor access point operating in the band 5.15 - 5.25 GHz, the maximum power spectral density shall not exceed 17 dBm in any 1 MHz band. <sup>note1</sup>

(ii) For an indoor access point operating in the band 5.15 - 5.25 GHz, the maximum power spectral density shall not exceed 17 dBm in any 1 MHz band. <sup>note1</sup>

(iii) For fixed point-to-point access points operating in the band 5.15 - 5.25 GHz, transmitters that employ a directional antenna gain greater than 23 dBi, a 1 dB reduction in maximum power spectral density is required for each 1 dB of antenna gain in excess of 23 dBi.

(iv) For mobile and portable client devices in the 5.15 - 5.25 GHz band, the maximum power spectral density shall not exceed 11 dBm in any 1 MHz band. <sup>note1</sup>

(2) For the 5.25 - 5.35 GHz and 5.47 - 5.725 GHz bands, the peak power spectral density shall not exceed 11 dBm in any 1 MHz band. <sup>note1</sup>

(3) For the band 5.725 - 5.85 GHz, the maximum power spectral density shall not exceed 30 dBm in any 500 kHz band. <sup>note1, note2</sup>

Note1: If transmitting antennas of directional gain greater than 6 dBi are used, the peak power spectral density shall be reduced by the amount in dB that the directional gain of the antenna exceeds 6 dBi.

Note2: Fixed point - to-point U-NII devices operating in this band may employ transmitting antennas with directional gain greater than 6 dBi without any corresponding reduction in transmitter conducted power. Fixed, point-to-point operations exclude the use of point-to-multipoint systems, omnidirectional applications, and multiple collocated transmitters transmitting the same information.

### Test Procedure

1. Use this procedure when the maximum peak conducted output power in the fundamental emission is used to demonstrate compliance.
2. Set the RBW = 1MHz for U-NII 1, U-NII 2A, U-NII C band and 510KHz for U-NII 3 band.
3. Set the VBW  $\geq 3 \times$  RBW.
4. Set the span to encompass the entire EBW.
5. Detector = peak.
6. Sweep time = auto couple.
7. Trace mode = max hold.
8. Allow trace to fully stabilize.
9. Use the peak marker function to determine the maximum power level.

### Test Configuration

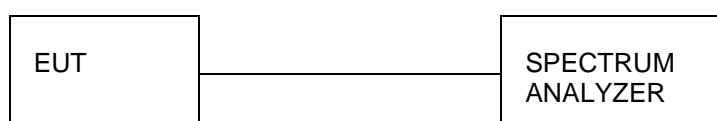

**Test Results**

Mode	TX Type	Frequency (MHz)	Maximum PSD (dBm/MHz)				Verdict
			ANT1	ANT2	MIMO	Limit	
802.11a	SISO	5180	-6.21	-7.71	/	<=11	Pass
		5200	-5.48	-7.28	/	<=11	Pass
		5240	-5.86	-7.80	/	<=11	Pass
802.11n (HT20)	MIMO	5180	-7.44	-9.06	-5.19	<=10.75	Pass
		5200	-7.26	-9.10	-5.21	<=10.75	Pass
		5240	-8.21	-9.43	-5.84	<=10.75	Pass
802.11n (HT40)	MIMO	5190	-9.54	-11.46	-7.45	<=10.75	Pass
		5230	-10.21	-11.59	-7.93	<=10.75	Pass
802.11ac (VHT20)	MIMO	5180	-7.40	-9.11	-5.25	<=10.75	Pass
		5200	-7.37	-9.14	-5.23	<=10.75	Pass
		5240	-7.20	-9.66	-5.31	<=10.75	Pass
802.11ac (VHT40)	MIMO	5190	-9.72	-11.51	-7.52	<=10.75	Pass
		5230	-10.18	-11.77	-8.06	<=10.75	Pass
802.11ac (VHT80)	MIMO	5210	-5.37	-8.14	-3.84	<=10.75	Pass

Mode	TX Type	Frequency (MHz)	Maximum PSD (dBm/500kHz)				Verdict
			ANT1	ANT2	MIMO	Limit	
802.11a	SISO	5745	-11.63	-11.98	/	<=30	Pass
		5785	-10.43	-12.10	/	<=30	Pass
		5825	-11.33	-13.15	/	<=30	Pass
802.11n (HT20)	MIMO	5745	-12.13	-13.44	-9.84	<=29.45	Pass
		5785	-11.81	-13.36	-9.58	<=29.45	Pass
		5825	-13.33	-13.99	-10.70	<=29.45	Pass
802.11n (HT40)	MIMO	5755	-14.37	-15.18	-11.88	<=29.45	Pass
		5795	-13.18	-14.88	-10.94	<=29.45	Pass
802.11ac (VHT20)	MIMO	5745	-11.94	-13.70	-9.79	<=29.45	Pass
		5785	-11.90	-13.53	-9.63	<=29.45	Pass
		5825	-13.24	-14.44	-10.80	<=29.45	Pass
802.11ac (VHT40)	MIMO	5755	-14.19	-15.25	-11.79	<=29.45	Pass
		5795	-13.16	-15.32	-11.15	<=29.45	Pass
802.11ac (VHT80)	MIMO	5775	-15.76	-17.54	-13.81	<=29.45	Pass

Test plot as follows  
ANT 1

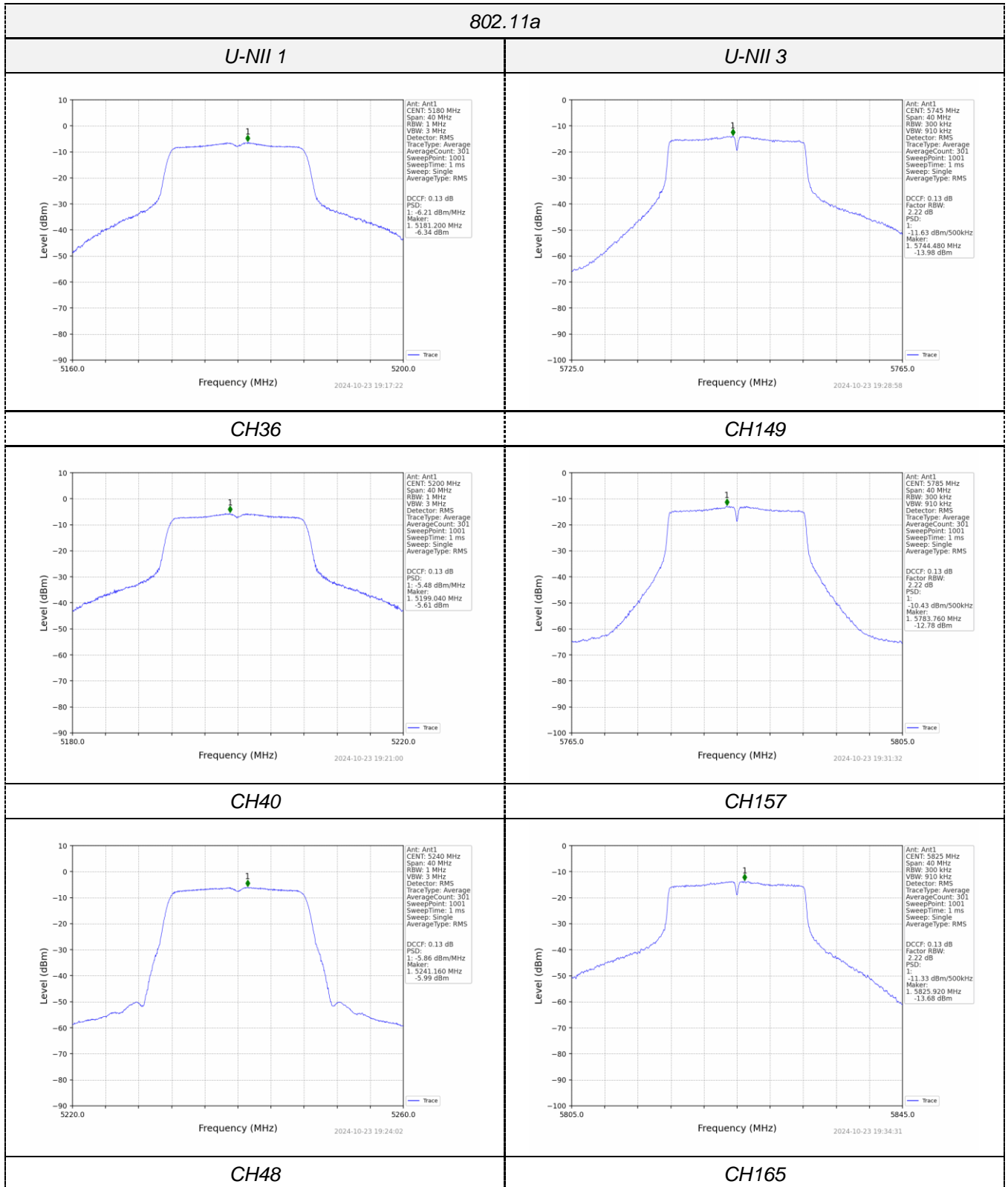



802.11n(HT20)

U-NII 1

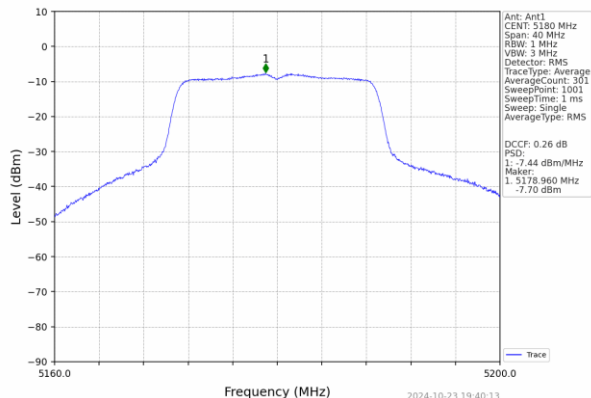

U-NII 3

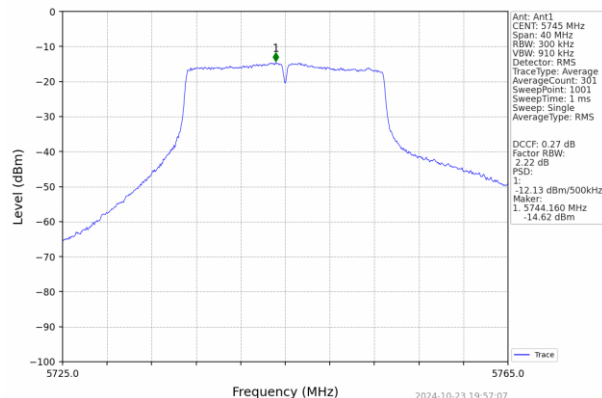

CH36

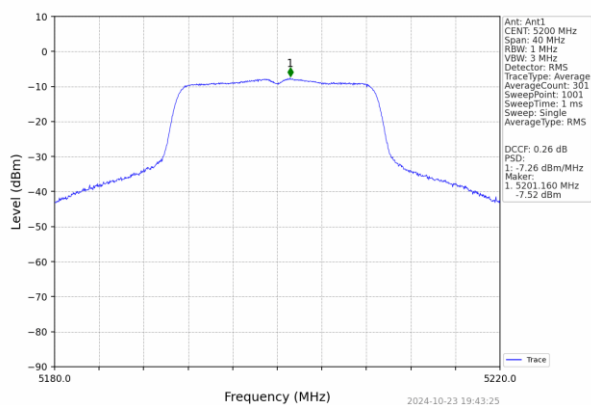

CH149

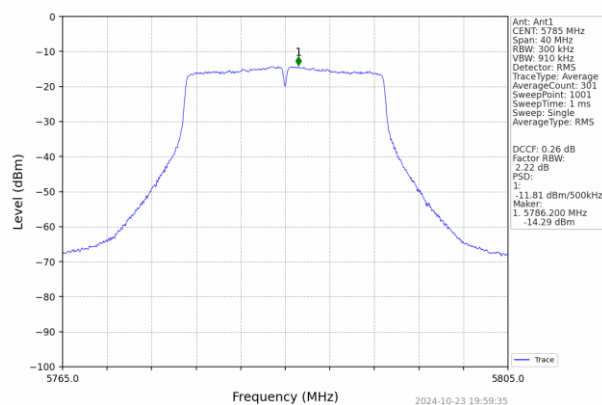

CH40

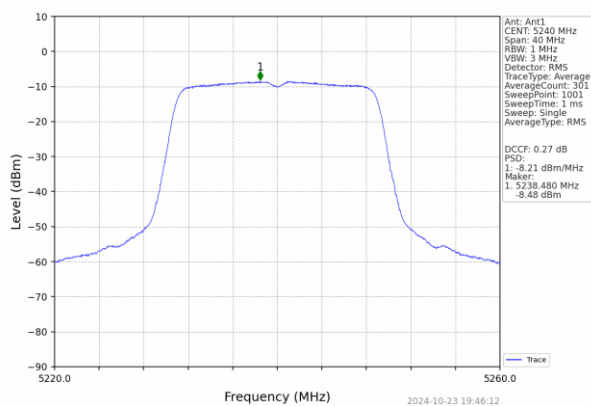

CH157

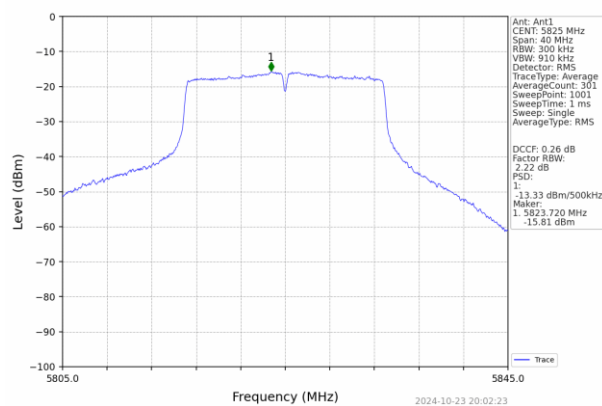

CH48

CH165

802.11n(HT40)

U-NII 1

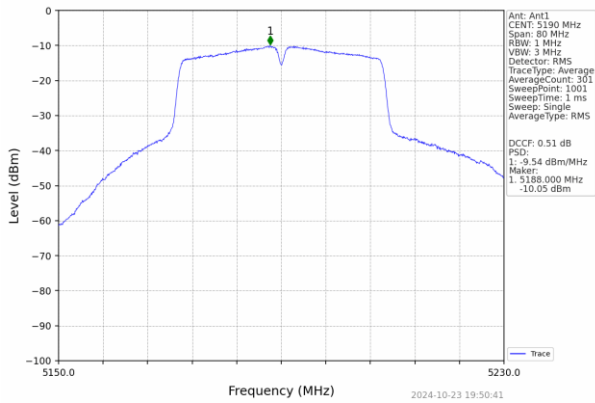

U-NII 3

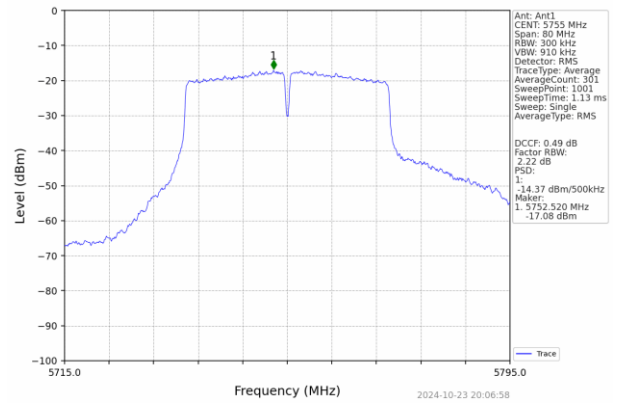

CH38

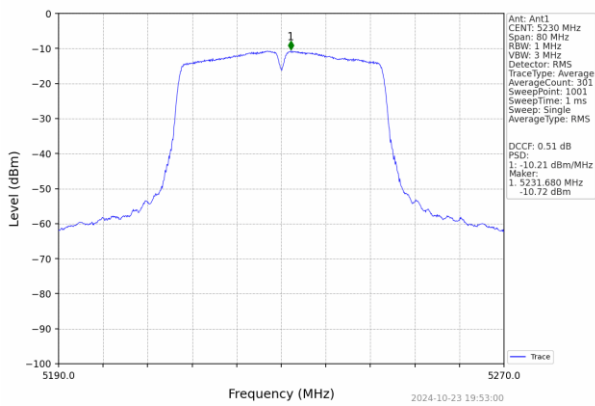

CH151

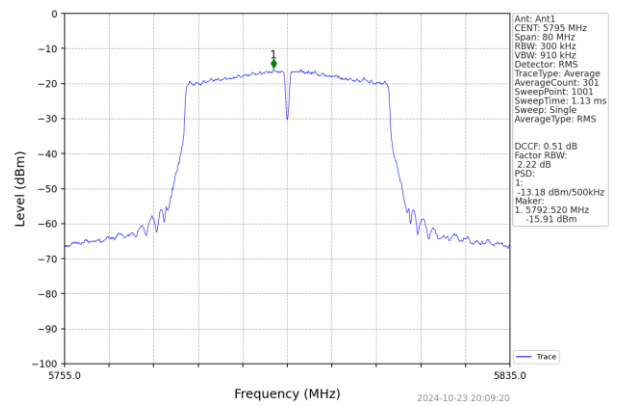

CH46

CH159

802.11ac(HT20)

U-NII 1

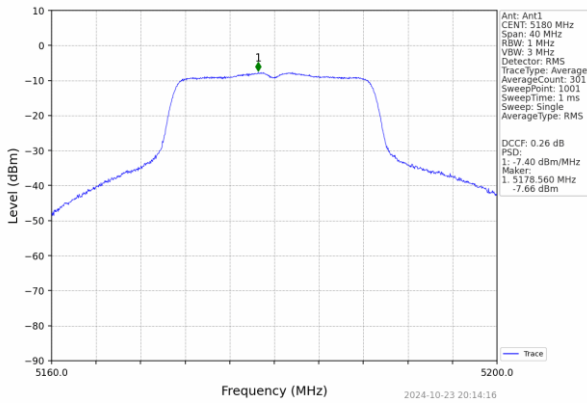

U-NII 3

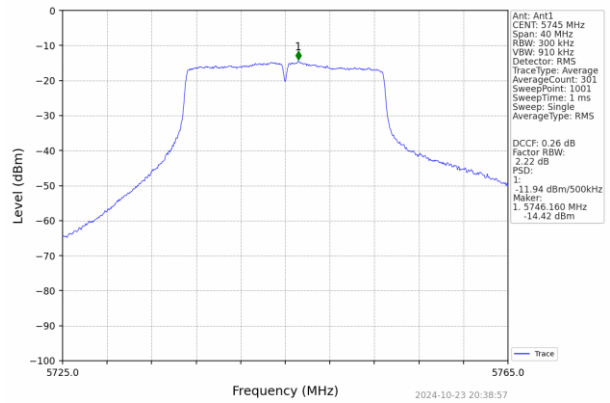

CH36

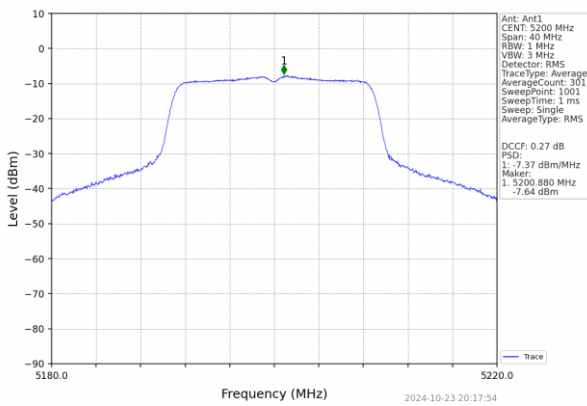

CH149

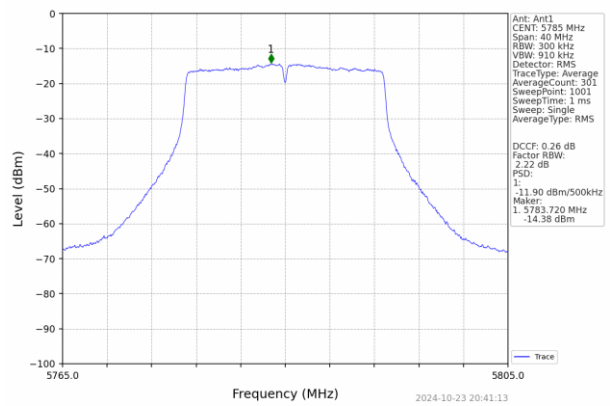

CH40

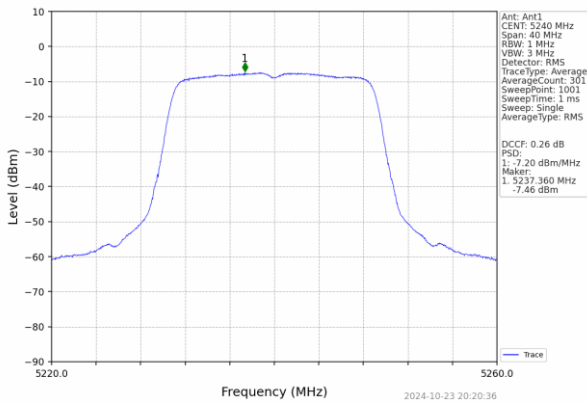

CH157

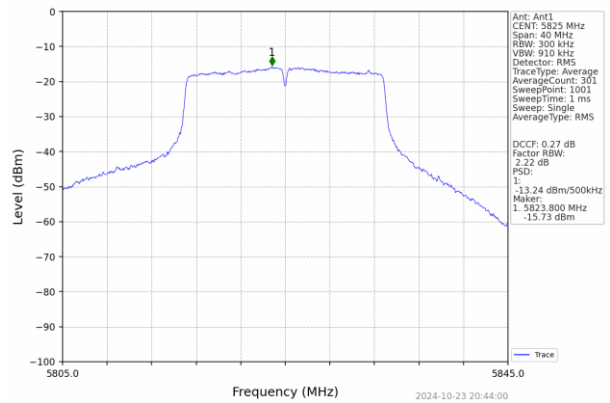

CH48

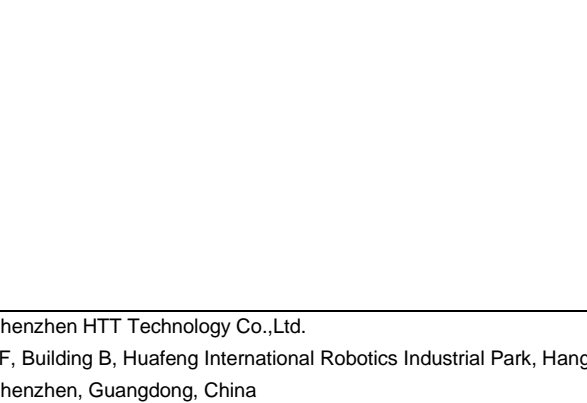

CH165



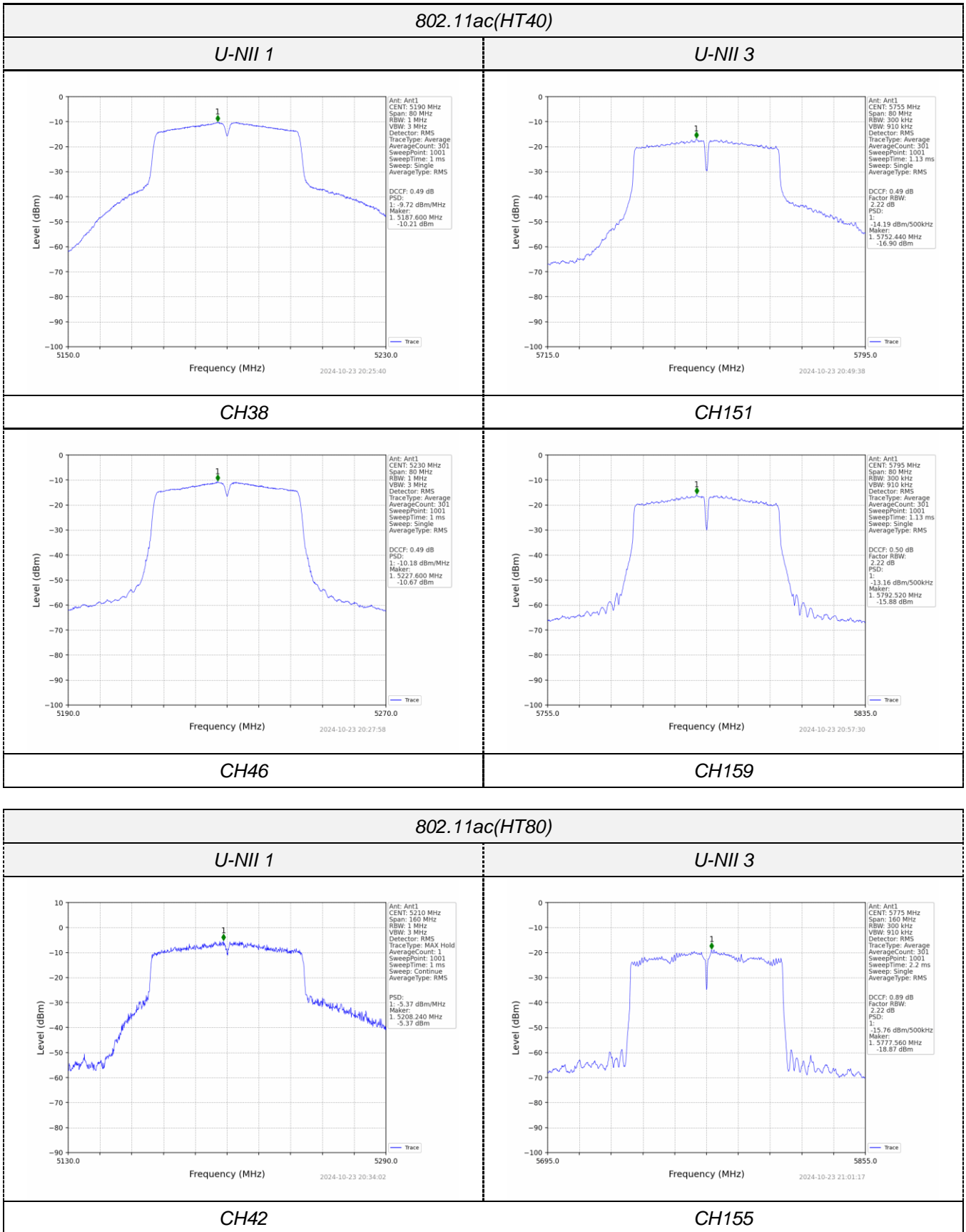

ANT 2

802.11a

U-NII 1

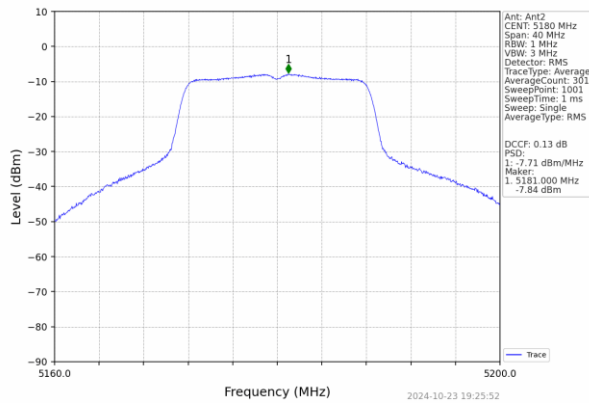

U-NII 3

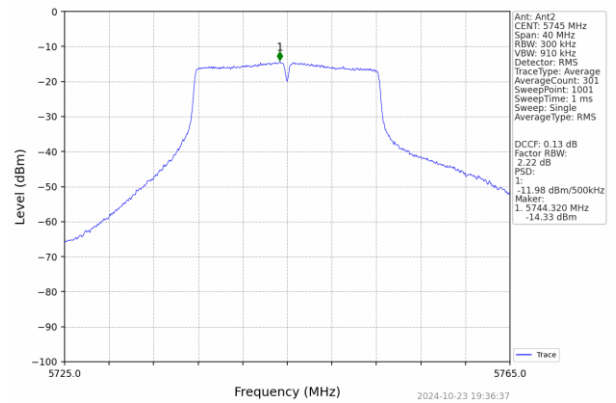

CH36

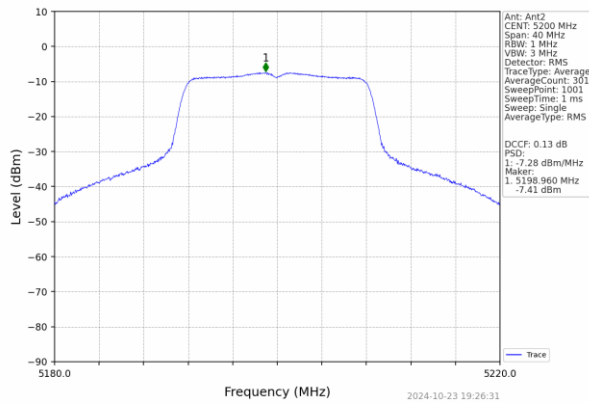

CH149

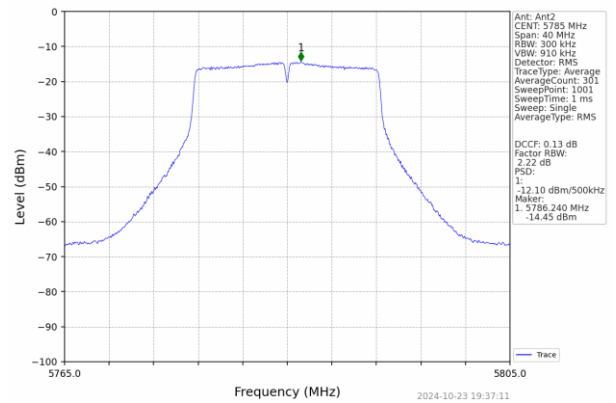

CH40

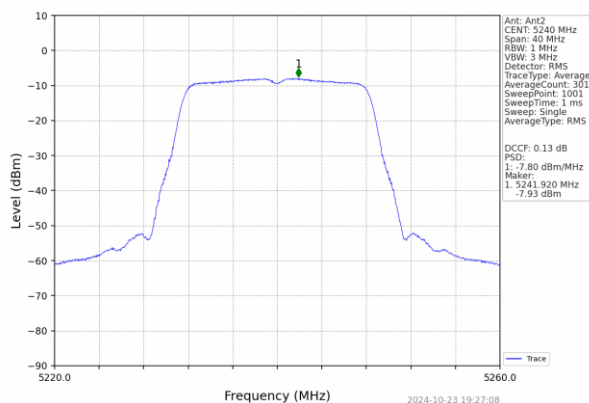

CH157

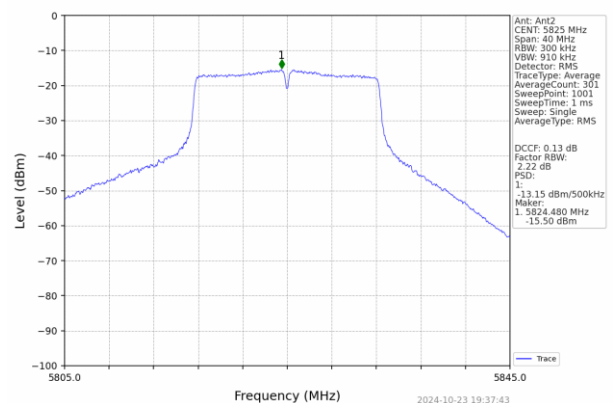

CH48

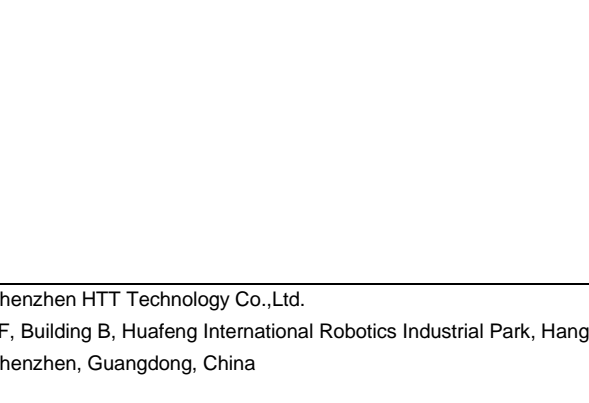

CH165



802.11n(HT20)

U-NII 1

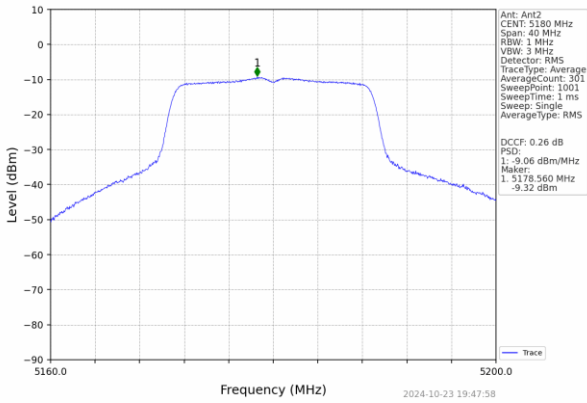

U-NII 3

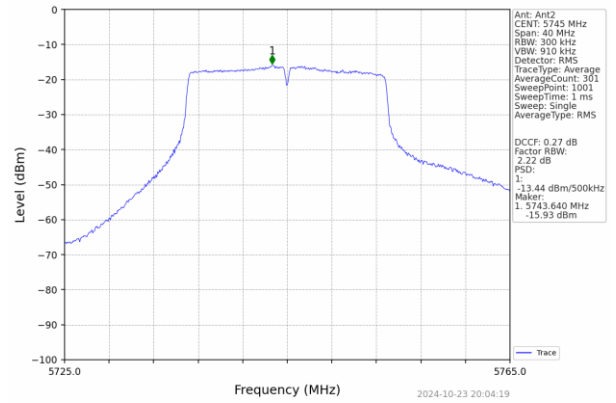

CH36

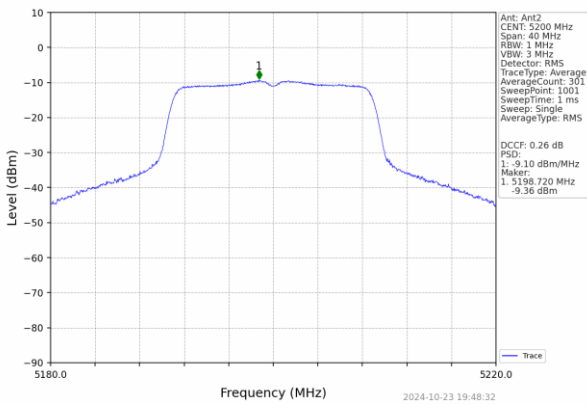

CH149

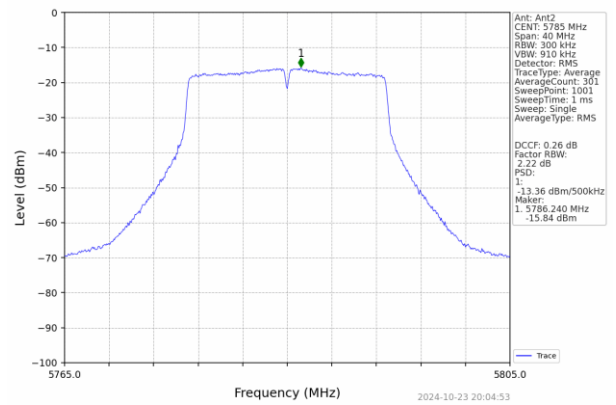

CH40

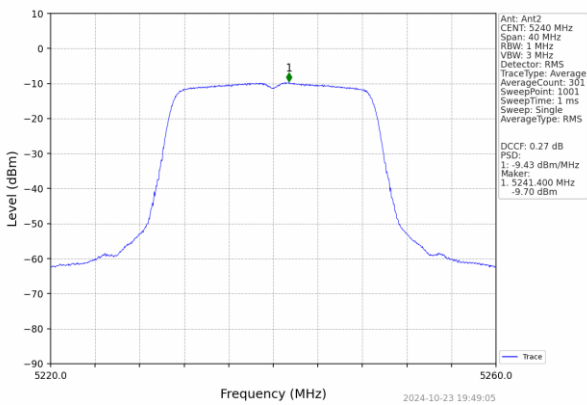

CH157

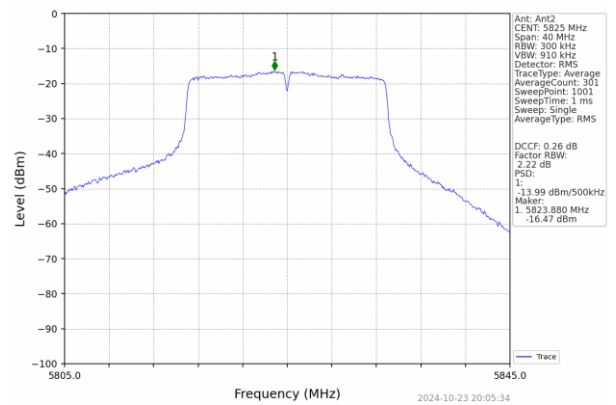

CH48

CH165

802.11n(HT40)

U-NII 1

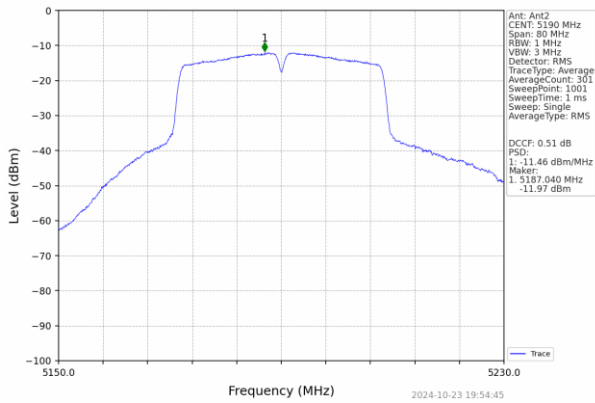

U-NII 3

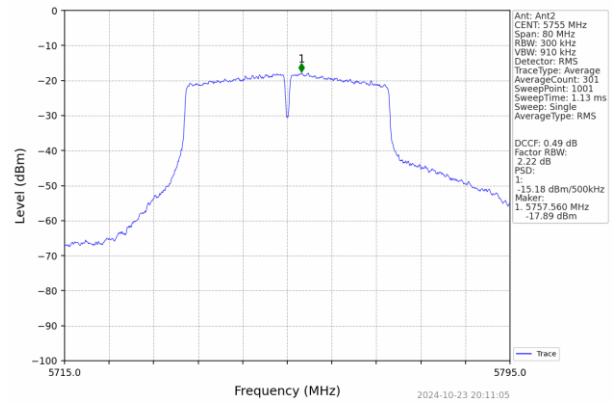

CH38

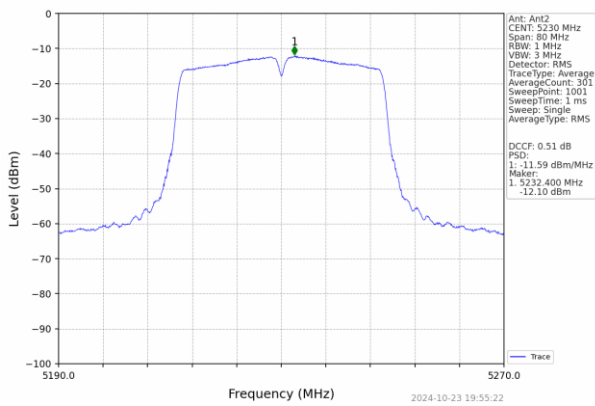

CH151

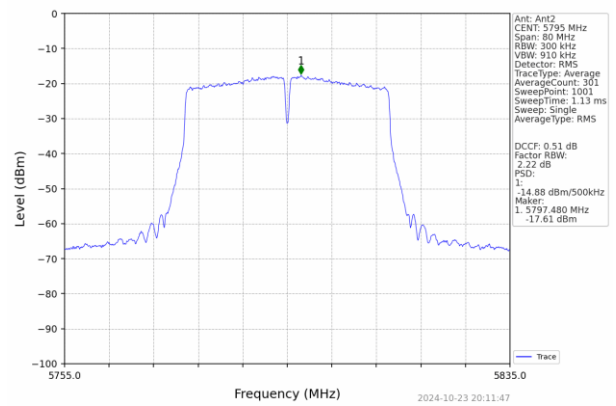

CH46

CH159

802.11ac(HT20)

U-NII 1

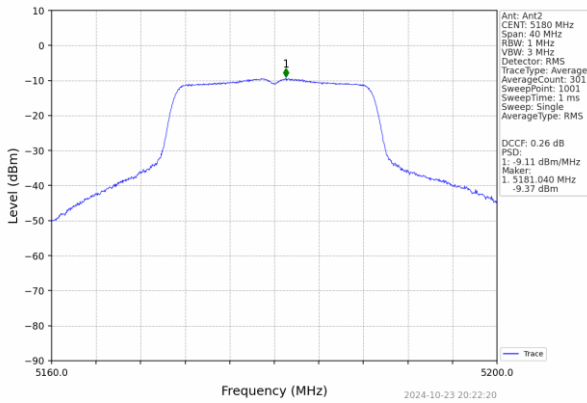

U-NII 3

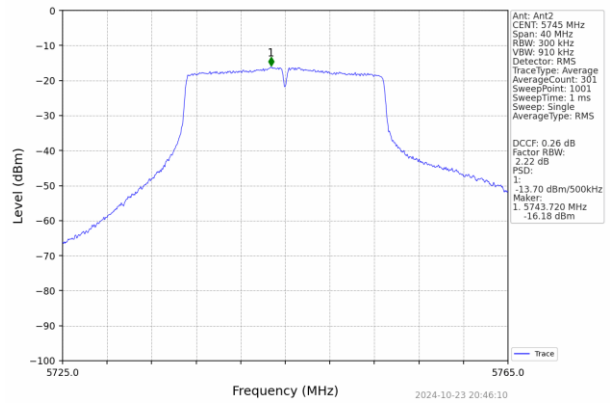

CH36

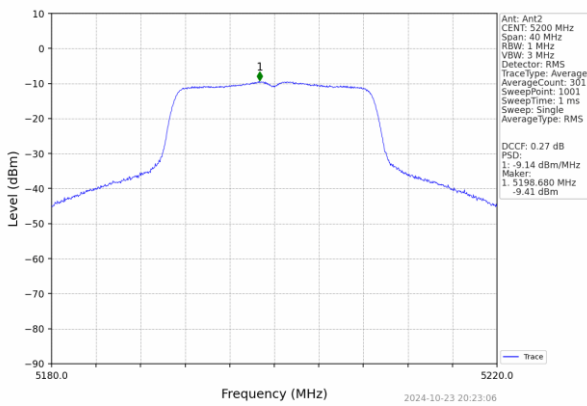

CH149

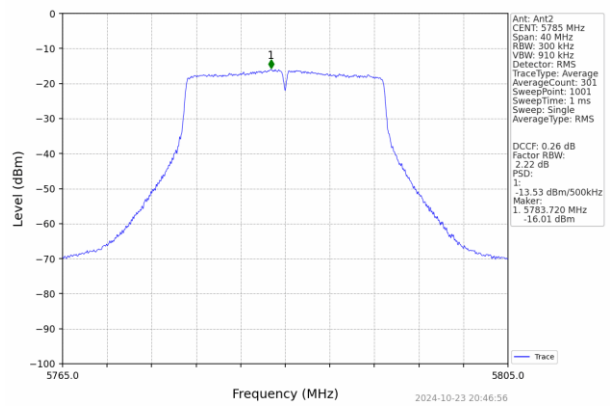

CH40

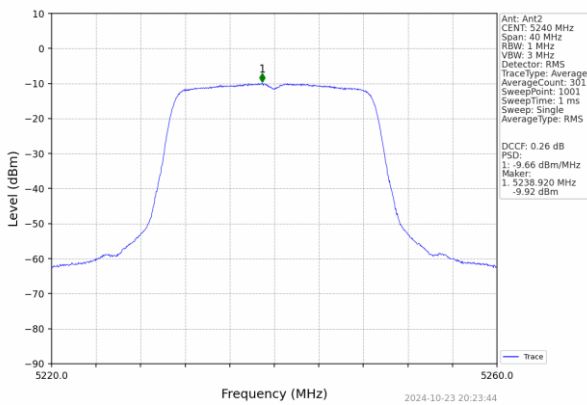

CH157

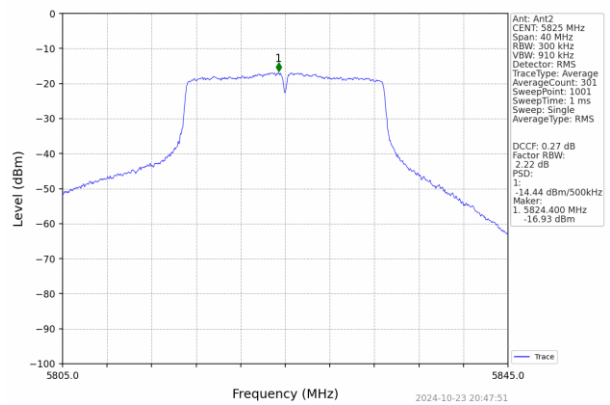

CH48

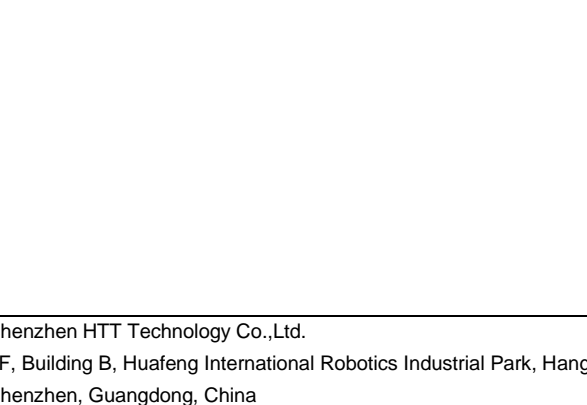

CH165

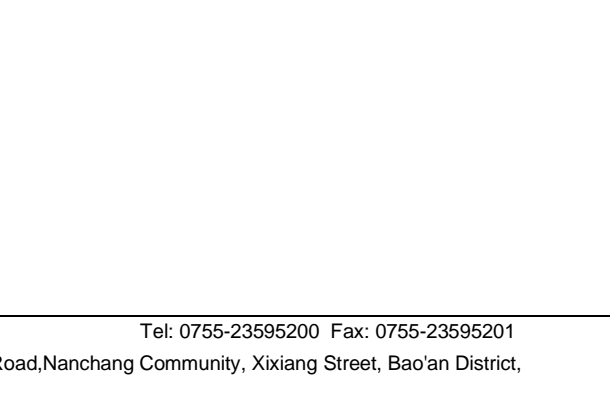



802.11ac(HT40)

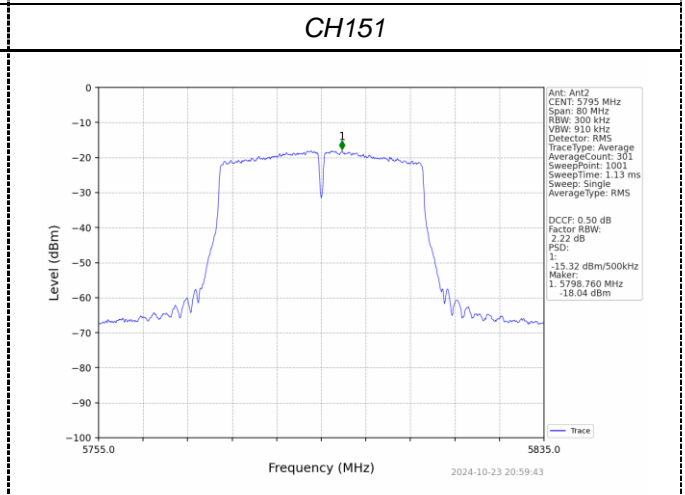
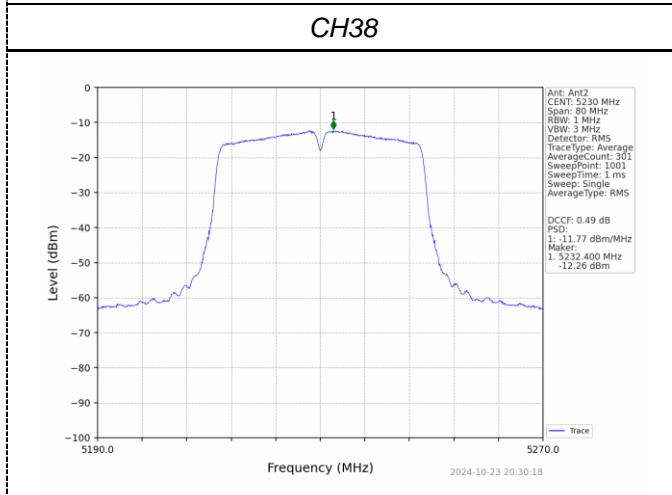
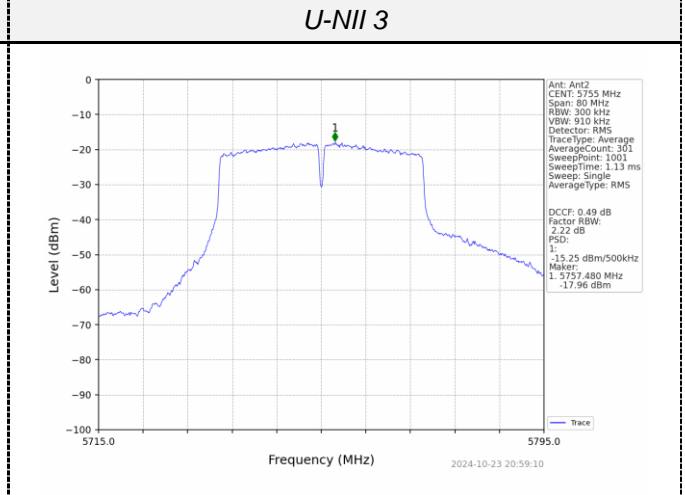
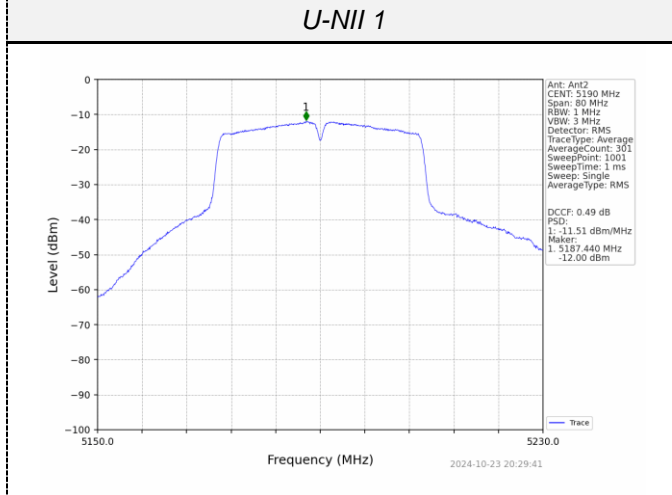

CH46

CH159

802.11ac(HT80)

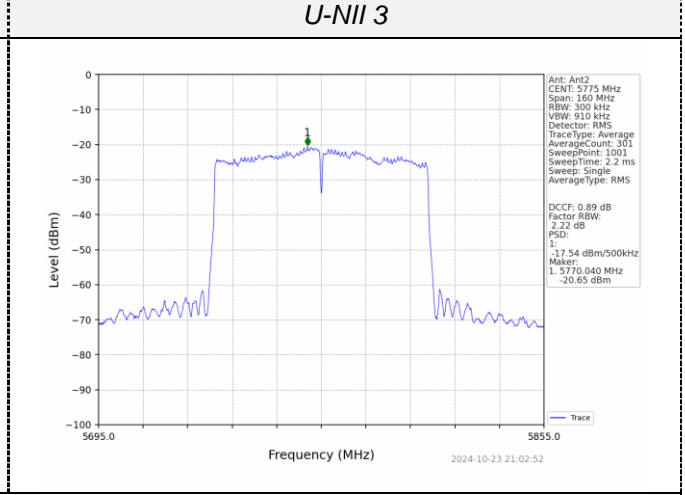
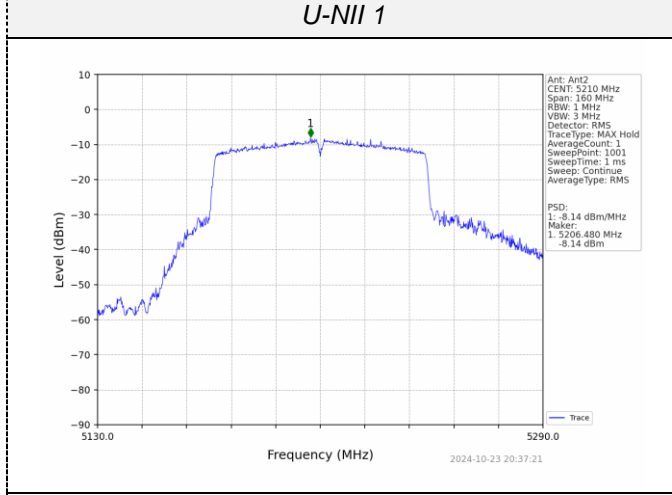

CH42

CH155

MIMO

802.11n(HT20)

U-NII 1

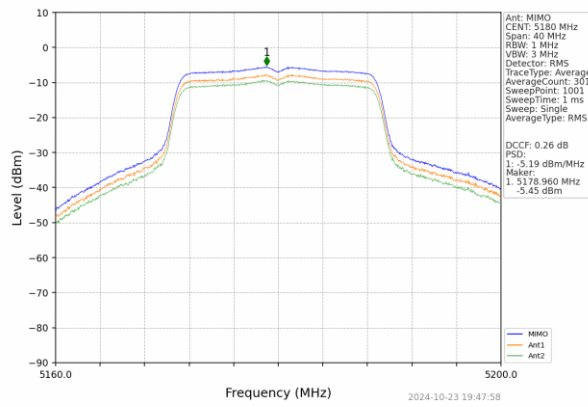

U-NII 3

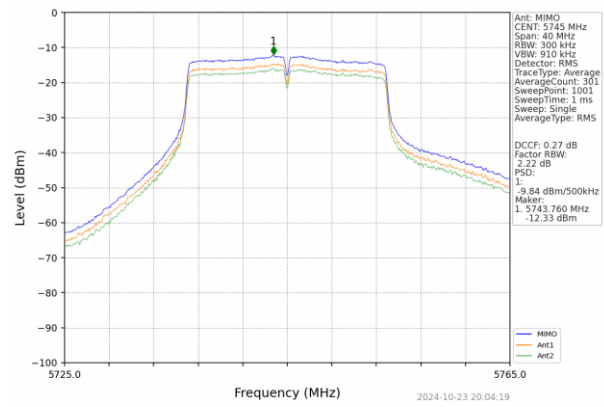

CH36

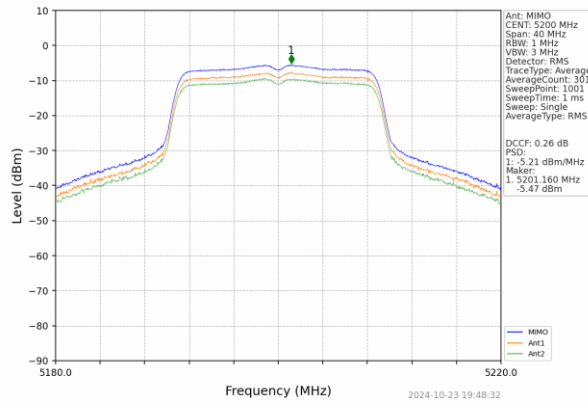

CH149

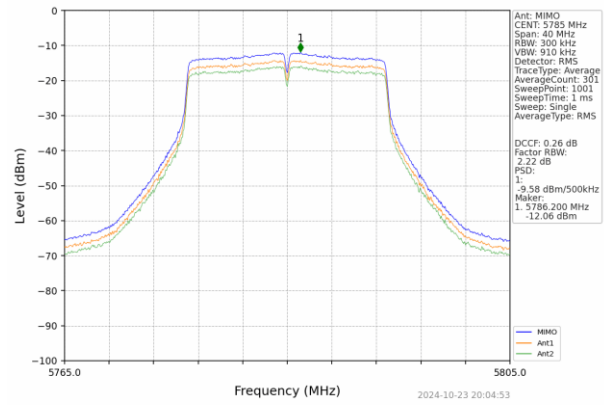

CH40

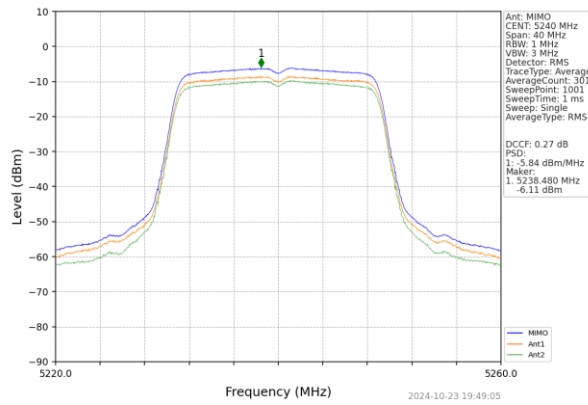

CH157

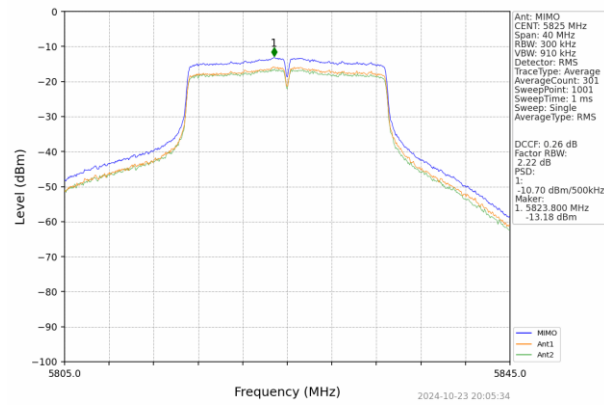

CH48

CH165

802.11n(HT40)

U-NII 1

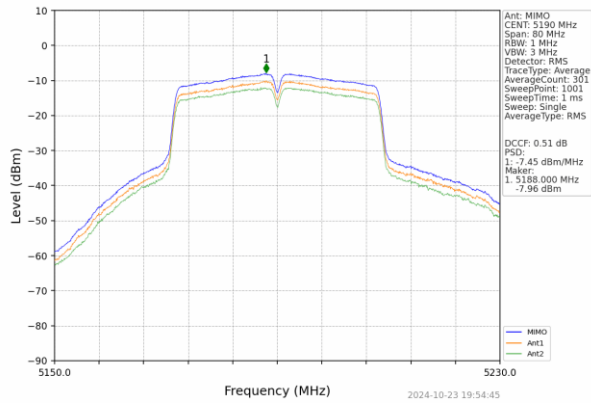

U-NII 3

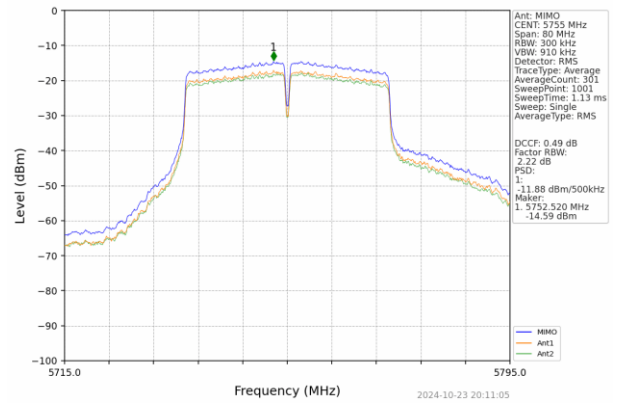

CH38

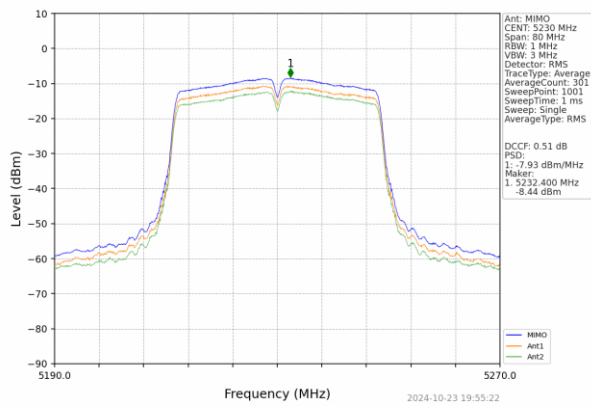

CH151

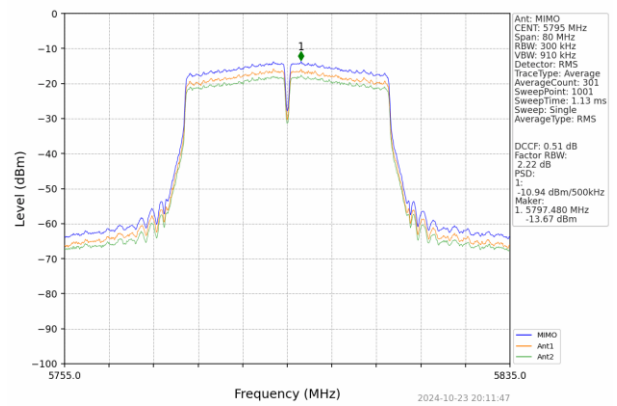

CH46

CH159