

FCC Test Report

FCC ID : JVPER-81
Equipment : Enhanced Wireless Receiver
Model No. : ER-81
Brand Name : ZOWIE
Applicant : BENQ CORPORATION
Address : 16 Jihu Road, Neihu, Taipei 114, Taiwan
Standard : 47 CFR FCC Part 15.249
Received Date : Jul. 20, 2023
Tested Date : Jul. 31 ~ Aug. 03, 2023

We, International Certification Corporation, would like to declare that the tested sample has been evaluated and in compliance with the requirement of the above standards. The test results contained in this report refer exclusively to the product. It shall not be reproduced except in full without the written approval of our laboratory.

Reviewed by:

Approved by:

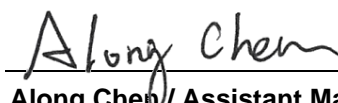

Along Chen / Assistant Manager



Gary Chang / Manager

Table of Contents

1	GENERAL DESCRIPTION	5
1.1	Information.....	5
1.2	Local Support Equipment List	7
1.3	Test Setup Chart	7
1.4	The Equipment List	9
1.5	Test Standards	10
1.6	Deviation from Test Standard and Measurement Procedure.....	10
1.7	Measurement Uncertainty	10
2	TEST CONFIGURATION.....	11
2.1	Testing Facility	11
2.2	The Worst Test Modes and Channel Details	11
3	TRANSMITTER TEST RESULTS	12
3.1	Unwanted Emission.....	12
3.2	20dB and Occupied Bandwidth.....	15
3.3	AC Power Line Conducted Emissions	16
4	TEST LABORATORY INFORMATION	17

Appendix A. Unwanted Emission
Appendix B. 20dB and Occupied Bandwidth
Appendix C. AC Power Line Conducted Emissions

Release Record

Report No.	Version	Description	Issued Date
FR372003	Rev. 01	Initial issue	Sep. 04, 2023

Summary of Test Results

FCC Rules	Test Items	Measured	Result
15.207	AC Power Line Conducted Emissions	[dBuV]: 0.150MHz 49.62 (Margin -16.38dB) - QP	Pass
15.249(a)	Field Strength of Fundamental	Meet the requirement of limit	Pass
15.249(a)(d)	Field Strength of Harmonics and Emissions Radiated outside of the Specified Frequency Bands	Meet the requirement of limit	Pass
15.215(c)	20dB bandwidth	Meet the requirement of limit	Pass
15.203	Antenna Requirement	Meet the requirement of limit	Pass

Declaration of Conformity:

The test results with all measurement uncertainty excluded are presented in accordance with the regulation limits or requirements declared by manufacturers.

Comments and Explanations:

The declared of product specification for EUT presented in the report are provided by the manufacturer, and the manufacturer takes all the responsibilities for the accuracy of product specification.

1 General Description

1.1 Information

1.1.1 Specification of the Equipment under Test (EUT)

RF General Information				
Frequency Range (MHz)	Modulation	Ch. Freq. (MHz)	Channel Number	Data Rate
2400-2483.5	GFSK	2403-2481	1-79 [79]	2Mbps

1.1.2 Antenna Details

Ant. No.	Brand	Model	Type	Connector	Gain (dBi)
1	BENQ Corporation	ER-81 ANT	Patch Antenna	NA	5.25

1.1.3 Power Supply Type of Equipment under Test (EUT)

Power Type	5Vdc from host
------------	----------------

1.1.4 Accessories

No.	Equipment	Description
1	USB cable	Brand: Le Prestique Electronics Manufacturing Model: F41-2500-061-004 Line: 2.05m non-shielded one core
2	USB cable	Brand: Le Prestique Electronics Manufacturing Ltd. Model: F41-2500-083-005 Line: 2.0m shielded without core

1.1.5 Channel List

Frequency band (MHz)				2400~2483.5			
Channel	Frequency (MHz)	Channel	Frequency (MHz)	Channel	Frequency (MHz)	Channel	Frequency (MHz)
1	2403	21	2423	41	2443	61	2463
2	2404	22	2424	42	2444	62	2464
3	2405	23	2425	43	2445	63	2465
4	2406	24	2426	44	2446	64	2466
5	2407	25	2427	45	2447	65	2467
6	2408	26	2428	46	2448	66	2468
7	2409	27	2429	47	2449	67	2469
8	2410	28	2430	48	2450	68	2470
9	2411	29	2431	49	2451	69	2471
10	2412	30	2432	50	2452	70	2472
11	2413	31	2433	51	2453	71	2473
12	2414	32	2434	52	2454	72	2474
13	2415	33	2435	53	2455	73	2475
14	2416	34	2436	54	2456	74	2476
15	2417	35	2437	55	2457	75	2477
16	2418	36	2438	56	2458	76	2478
17	2419	37	2439	57	2459	77	2479
18	2420	38	2440	58	2460	78	2480
19	2421	39	2441	59	2461	79	2481
20	2422	40	2442	60	2462	---	---

1.1.6 Test Tool and Duty Cycle

Test Tool	radio_test, Version: 1.0.0.0	
Duty Cycle and Duty Factor	Duty Cycle (%)	Duty Factor (dB)
	100	0

1.1.7 Power Index of Test Tool

Modulation Mode	Test Frequency (MHz)		
	2403	2441	2481
GFSK	4dBm	4dBm	4dBm

1.2 Local Support Equipment List

Support Equipment List					
No.	Equipment	Brand	Model	FCC ID	Remarks
1	Laptop	DELL	Latitude 5400	DoC	---
2	Mouse for e-Sports	ZOWIE	U2-D	---	Provided by applicant.
3	Adapter	Samsung	ETA-U90JWS	---	---

1.3 Test Setup Chart

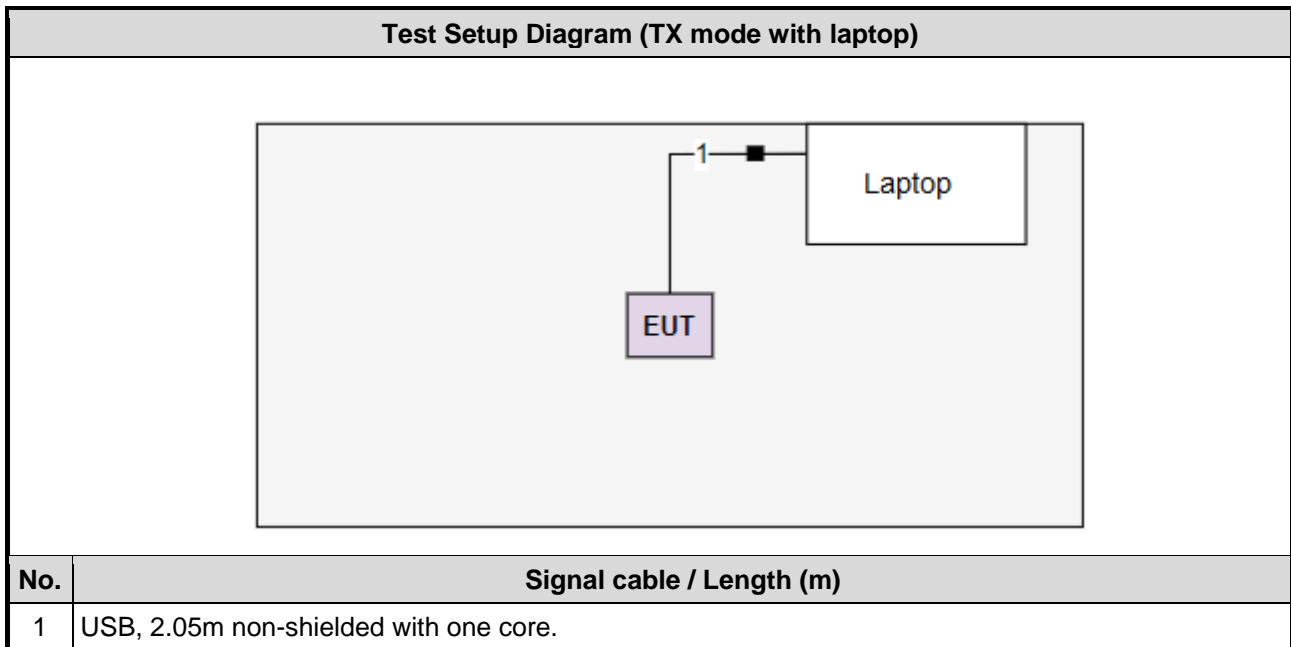

Test Setup Diagram (charging mode with laptop)

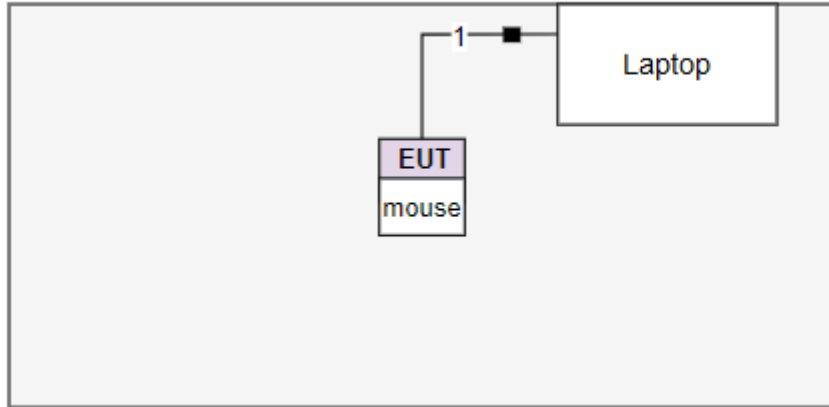

No.	Signal cable / Length (m)
-----	---------------------------

1	USB, 2.05m non-shielded with one core.
---	--

Test Setup Diagram (charging mode with adapter)

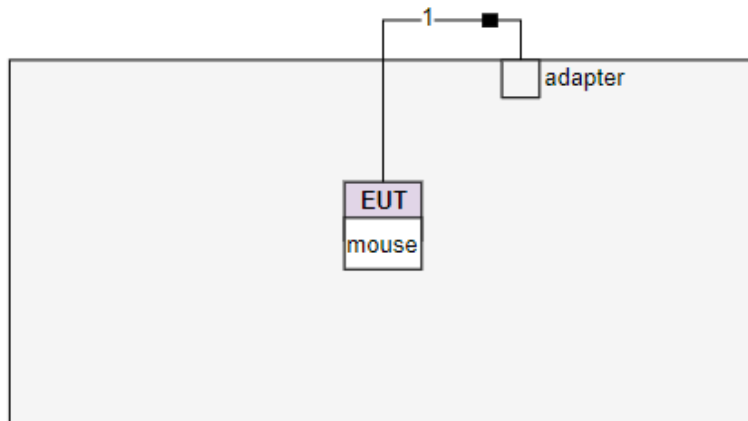

No.	Signal cable / Length (m)
-----	---------------------------

1	USB, 2.05m non-shielded with one core.
---	--

1.4 The Equipment List

Test Item	Conducted Emission				
Test Site	Conduction room 1 / (CO01-WS)				
Tested Date	Aug. 03, 2023				
Instrument	Brand	Model No.	Serial No.	Calibration Date	Calibration Until
Receiver	R&S	ESR3	101658	Feb. 17, 2023	Feb. 16, 2024
LISN	R&S	ENV216	101579	May 09, 2023	May 08, 2024
LISN (Support Unit)	SCHWARZBECK	Schwarzbeck 8127	8127667	Jan .03, 2023	Jan .02, 2024
RF Cable-CON	Woken	CFD200-NL	CFD200-NL-001	Oct. 17, 2022	Oct. 16, 2023
50 ohm terminal (Support Unit)	NA	50	01	Jun. 14, 2023	Jun. 13, 2024
Measurement Software	AUDIX	e3	6.120210k	NA	NA

Note: Calibration Interval of instruments listed above is one year.

Test Item	Radiated Emission				
Test Site	966 chamber3 / (03CH03-WS)				
Tested Date	Jul. 31, 2023				
Instrument	Brand	Model No.	Serial No.	Calibration Date	Calibration Until
Receiver	R&S	ESR3	101657	Mar. 03, 2023	Mar. 02, 2024
Spectrum Analyzer	R&S	FSV40	101499	Mar. 16, 2023	Mar. 15, 2024
Loop Antenna	R&S	HFH2-Z2	100330	Nov. 01, 2022	Oct. 31, 2023
Bilog Antenna	SCHWARZBECK	VULB9168	VULB9168-685	Jul. 04, 2023	Jul. 03, 2024
Horn Antenna 1G-18G	SCHWARZBECK	BBHA 9120 D	BBHA 9120 D 1206	Dec. 15, 2022	Dec. 14, 2023
Horn Antenna 18G-40G	SCHWARZBECK	BBHA 9170	BBHA 9170517	Oct. 27, 2022	Oct. 26, 2023
Preamplifier	EMC	EMC02325	980187	Jul. 10, 2023	Jul. 09, 2024
Preamplifier	Agilent	83017A	MY39501308	Oct. 26, 2022	Oct. 25, 2023
Preamplifier	EMC	EMC184045SE	980903	Jul. 17, 2023	Jul. 16, 2024
Loop Antenna Cable	KOAX KABEL	101354-BW	101354-BW	Oct. 04, 2022	Oct. 03, 2023
LF cable-0.8M	EMC	EMC8D-NM-NM-800	EMC8D-NM-NM-800-001	Sep. 23, 2022	Sep. 22, 2023
LF cable-3M	EMC	EMC8D-NM-NM-3000	131103	Sep. 23, 2022	Sep. 22, 2023
LF cable-13M	EMC	EMC8D-NM-NM-13000	131104	Sep. 23, 2022	Sep. 22, 2023
RF cable-3M	HUBER+SUHNER	SUCOFLEX104	MY22620/4	Sep. 23, 2022	Sep. 22, 2023
RF cable-8M	EMC	EMC104-SM-SM-8000	181107	Sep. 23, 2022	Sep. 22, 2023
Attenuator	Pasternack	PE7005-10	10-3	Oct. 14, 2022	Oct. 13, 2023
HIGHPASS FILTER	WI	WHK3.1-18G-10SS	43	Sep. 28, 2022	Sep. 27, 2023
Measurement Software	AUDIX	e3	6.120210g	NA	NA

Note: Calibration Interval of instruments listed above is one year.

1.5 Test Standards

47 CFR FCC Part 15.249
ANSI C63.10-2013

1.6 Deviation from Test Standard and Measurement Procedure

None

1.7 Measurement Uncertainty

The measurement uncertainties given below are based on a 95% confidence level (based on a coverage factor ($k=2$)).

Measurement Uncertainty	
Parameters	Uncertainty
Bandwidth	± 34.130 Hz
AC conducted emission	± 2.92 dB
Unwanted Emission ≤ 1 GHz	± 3.96 dB
Unwanted Emission > 1 GHz	± 4.51 dB

2 Test Configuration

2.1 Testing Facility

Test Laboratory	International Certification Corporation
Test Site	CO01-WS
Address of Test Site	No.3-1, Lane 6, Wen San 3rd St., Kwei Shan Dist., Tao Yuan City 33381, Taiwan (R.O.C.)
Test Site	03CH03-WS
Address of Test Site	No.14-1, Lane 19, Wen San 3rd St., Kwei Shan Dist., Tao Yuan City 33381, Taiwan (R.O.C.)

- FCC Designation No.: TW0009
- FCC site registration No.: 207696
- ISED#: 10807C
- CAB identifier: TW2732

2.2 The Worst Test Modes and Channel Details

Test item	Mode	Test Frequency (MHz)	Data Rate	Mode
AC Power Line Conducted Emissions	GFSK	2441	2 Mbps	TX
	Charging	-	-	Charging with laptop
	Charging	-	-	Charging with adapter
Unwanted Emissions ≤ 1GHz	GFSK	2441	2 Mbps	TX
	Charging	-	-	Charging with laptop
	Charging	-	-	Charging with adapter
Unwanted Emissions > 1GHz	GFSK	2403, 2441, 2481	2 Mbps	TX
20dB bandwidth Field Strength of Fundamental	GFSK	2403, 2441, 2481	2 Mbps	TX

Note: Two USB cable (2.05m and 2m) had been covered during the pretest, and found that USB cable 2.05m was the worst case and was selected for final test.

3 Transmitter Test Results

3.1 Unwanted Emission

This section includes field strength of fundamental, field strength of harmonics and emissions radiated outside of the operating frequency bands.

3.1.1 Limit of field strength of fundamental and field strength of harmonics

Fundamental Frequency	Field strength of fundamental (millivolts/meter)	Field strength of harmonics (microvolts/meter)
2400–2483.5 MHz	50	500

3.1.2 Limit of Unwanted Emissions

Emissions radiated outside of the specified frequency bands, except for harmonics, shall be attenuated by at least 50 dB below the level of the fundamental or to the general radiated emission limits in below table, whichever is the lesser attenuation.

Radiated emission limits			
Frequency Range (MHz)	Field Strength (uV/m)	Field Strength (dBuV/m)	Measure Distance (m)
0.009~0.490	2400/F(kHz)	48.5 - 13.8	300
0.490~1.705	24000/F(kHz)	33.8 - 23	30
1.705~30.0	30	29	30
30~88	100	40	3
88~216	150	43.5	3
216~960	200	46	3
Above 960	500	54	3

Note 1:
Qusai-Peak value is measured for frequency below 1GHz except for 9–90 kHz, 110–490 kHz frequency band. Peak and average value are measured for frequency above 1GHz. The limit on average radio frequency emission is as above table. The limit on peak radio frequency emissions is 20 dB above the maximum permitted average emission limit

Note 2:
Measurements may be performed at a distance other than what is specified provided. When performing measurements at a distance other than that specified, the results shall be extrapolated to the specified distance using an extrapolation factor as below, Frequency at or above 30 MHz: 20 dB/decade Frequency below 30 MHz: 40 dB/decade.

3.1.3 Test Procedures

1. Measurement is made at a semi-anechoic chamber that incorporates a turntable allowing a EUT rotation of 360°. A continuously-rotating, remotely-controlled turntable is installed at the test site to support the EUT and facilitate determination of the direction of maximum radiation for each EUT emission frequency. The EUT is placed at test table. For emissions testing at or below 1 GHz, the table height is 80 cm above the reference ground plane. For emission measurements above 1 GHz, the table height is 1.5 m
2. Measurement is made with the antenna positioned in both the horizontal and vertical planes of polarization. The measurement antenna is varied in height (1m ~ 4m) above the reference ground plane to obtain the maximum signal strength. Distance between EUT and antenna is 3 m.
3. This investigation is performed with the EUT rotated 360°, the antenna height scanned between 1 m and 4 m, and the antenna rotated to repeat the measurements for both the horizontal and vertical antenna polarizations.

Note:

1. Radiated emission below 1GHz
120kHz measurement bandwidth of test receiver and Quasi-peak detector is for radiated emission
2. Radiated emission above 1GHz / Peak value except fundamental
RBW=1MHz, VBW=3MHz and Peak detector
3. Radiated emission above 1GHz / Average value for field strength of fundamental and harmonics
The average value is: Average = Peak value + 20log(Duty cycle) Where the duty factor is calculated from following formula:

$$20\log(\text{Duty cycle}) = 20\log \frac{0.073913 \times 100 \text{ ms}}{100 \text{ ms}} = -22.63\text{dB}$$

4. Radiated emission above 1GHz / Average value for other emissions
RBW=1MHz, VBW=1/T and Peak detector
5. Radiated emission Peak value for fundamental
RBW=2MHz, VBW=10MHz and Peak detector

3.1.4 Test Setup

Radiated Emissions below 1 GHz

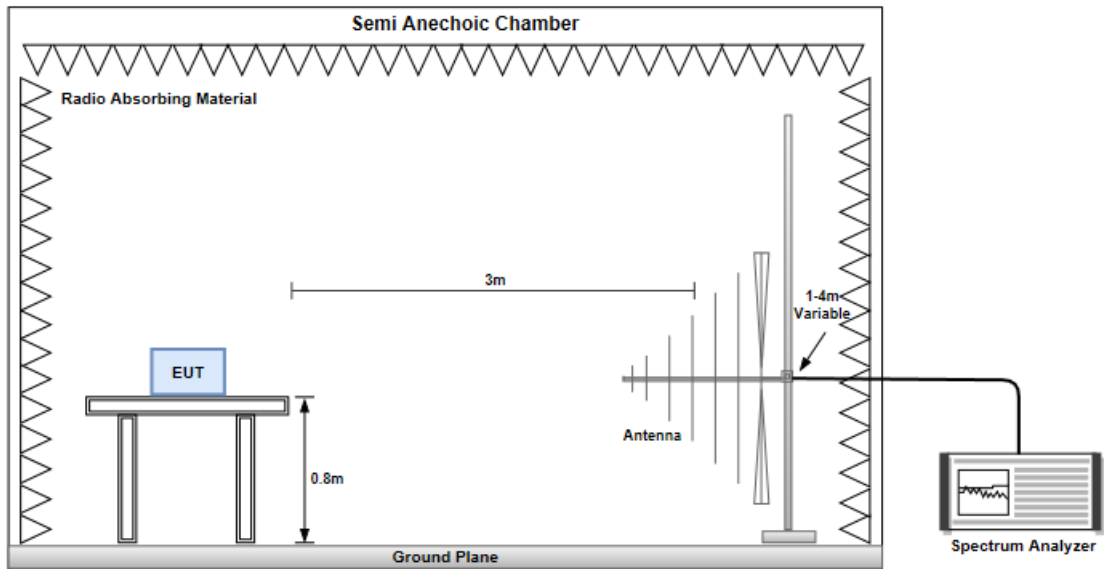

Radiated Emissions above 1 GHz

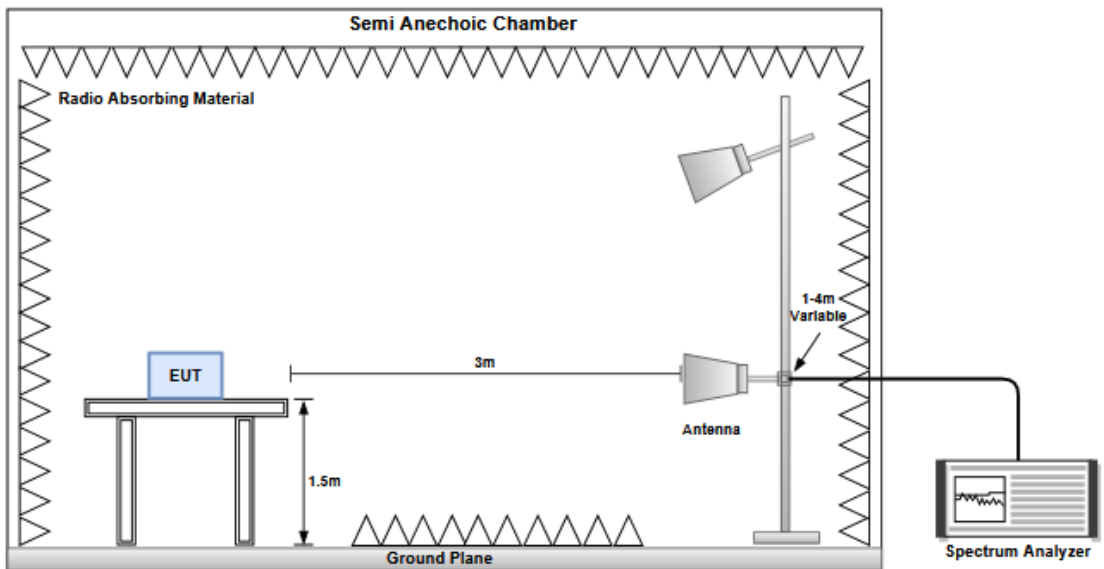

3.1.5 Test Results

Refer to Appendix A.

3.2 20dB and Occupied Bandwidth

3.2.1 Test Procedures

1. Set resolution bandwidth (RBW) = 20 kHz, Video bandwidth = 100 kHz.
2. Detector = Peak(20 dB bandwidth) / Sample(Occupied bandwidth), Trace mode = max hold
3. Sweep = auto couple, Allow the trace to stabilize.
4. Measure the maximum width of the emission that is constrained by the frequencies associated with the two outermost amplitude points (upper and lower) that are attenuated by 20dB relative to the maximum level measured in the fundamental emission.
5. Use the occupied measurement function of spectrum analyzer to measure 99% occupied bandwidth.

3.2.2 Test Setup

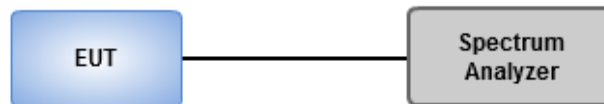

3.2.3 Test Results

Ambient Condition	24°C / 62%	Tested By	Brad Wu
--------------------------	------------	------------------	---------

Refer to Appendix B.

3.3 AC Power Line Conducted Emissions

3.3.1 Limit of AC Power Line Conducted Emissions

Conducted Emissions Limit		
Frequency Emission (MHz)	Quasi-Peak	Average
0.15-0.5	66 - 56 *	56 - 46 *
0.5-5	56	46
5-30	60	50

Note 1: * Decreases with the logarithm of the frequency.

3.3.2 Test Procedures

1. The device is placed on a test table, raised 80 cm above the reference ground plane. The vertical conducting plane is located 40 cm to the rear of the device.
2. The device is connected to line impedance stabilization network (LISN) and other accessories are connected to other LISN. Measured levels of AC power line conducted emission are across the 50 Ω LISN port.
3. AC conducted emission measurements is made over frequency range from 150 kHz to 30 MHz.
4. This measurement was performed with AC 120V / 60Hz.

3.3.3 Test Setup

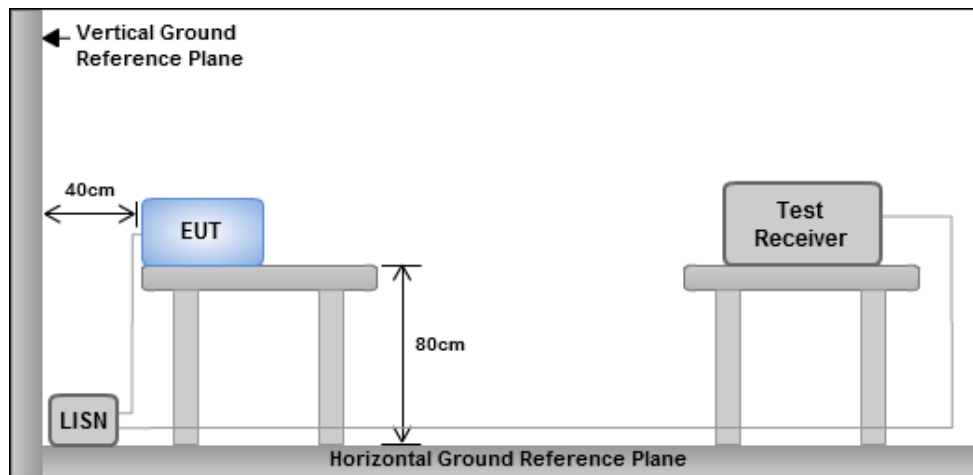

- Note: 1. Support units were connected to second LISN.
 2. Both of LISNs (AMN) are 80 cm from EUT and at least 80 cm from other units and other metal planes

3.3.4 Test Results

Refer to Appendix C.

4 Test laboratory information

Established in 2012, ICC provides foremost EMC & RF Testing and advisory consultation services by our skilled engineers and technicians. Our services employ a wide variety of advanced edge test equipment and one of the widest certification extents in the business.

International Certification Corporation (EMC and Wireless Communication Laboratory), it is our definitive objective is to institute long term, trust-based associations with our clients. The expectation we set up with our clients is based on outstanding service, practical expertise and devotion to a certified value structure. Our passion is to grant our clients with best EMC / RF services by oriented knowledgeable and accommodating staff.

Our Test sites are located at Linkou District and Kwei Shan District. Location map can be found on our website <http://www.icertifi.com.tw>.

Linkou

Tel: 886-2-2601-1640

No.30-2, Ding Fwu Tsuen, Lin Kou
District, New Taipei City, Taiwan
(R.O.C.)

Kwei Shan

Tel: 886-3-271-8666

No.3-1, Lane 6, Wen San 3rd
St., Kwei Shan Dist., Tao Yuan
City 33381, Taiwan (R.O.C.)
No.2-1, Lane 6, Wen San 3rd
St., Kwei Shan Dist., Tao Yuan
City 33381, Taiwan (R.O.C.)

Kwei Shan Site II

Tel: 886-3-271-8640

No.14-1, Lane 19, Wen San 3rd
St., Kwei Shan Dist., Tao Yuan
City 33381, Taiwan (R.O.C.)

If you have any suggestion, please feel free to contact us as below information.

Tel: 886-3-271-8666

Fax: 886-3-318-0345

Email: ICC_Service@icertifi.com.tw

==END==



Unwanted Emissions (Below 1GHz)

Modulation	GFSK	Test Freq. (MHz)	2441						
Polarization	Horizontal								
Test By : Paul Lin Temperature(°C): 24 Humidity(%): 62									
<p>The graph displays the unwanted emission levels across a frequency range from 30 MHz to 1000 MHz. A red step-like line represents the CLASS-B limit, which is constant at 40 dBuV/m until 100 MHz, then steps up to 45 dBuV/m at 200 MHz, and remains constant thereafter. Six blue vertical lines indicate measured peaks at various frequencies, labeled 1 through 6. The emission levels for these peaks are significantly below the CLASS-B limit.</p>									
	Freq. MHz	Emission level dBuV/m	Limit dBuV/m	Margin dB	SA reading dBuV	Factor dB/m	Remark	ANT High cm	Turn Table deg
1	46.49	24.78	40.00	-15.22	32.79	-8.01	Peak	---	---
2	115.36	30.35	43.50	-13.15	41.73	-11.38	Peak	---	---
3	224.00	30.02	46.00	-15.98	42.17	-12.15	Peak	---	---
4	382.11	28.64	46.00	-17.36	34.04	-5.40	Peak	---	---
5	445.16	33.31	46.00	-12.69	36.85	-3.54	Peak	---	---
6	508.21	28.72	46.00	-17.28	30.84	-2.12	Peak	---	---

Note 1: Emission Level (dBuV/m) = SA Reading (dBuV) + Factor* (dB/m)
 *Factor includes antenna factor , cable loss and amplifier gain
 Note 2: Margin (dB) = Emission level (dBuV/m) – Limit (dBuV/m).
 Note 3: All spurious emissions below 30MHz are more than 20 dB below the limit.



Modulation	GFSK	Test Freq. (MHz)	2441
Polarization	Vertical		

Test By :Paul Lin Temperature(°C):24 Humidity(%):62

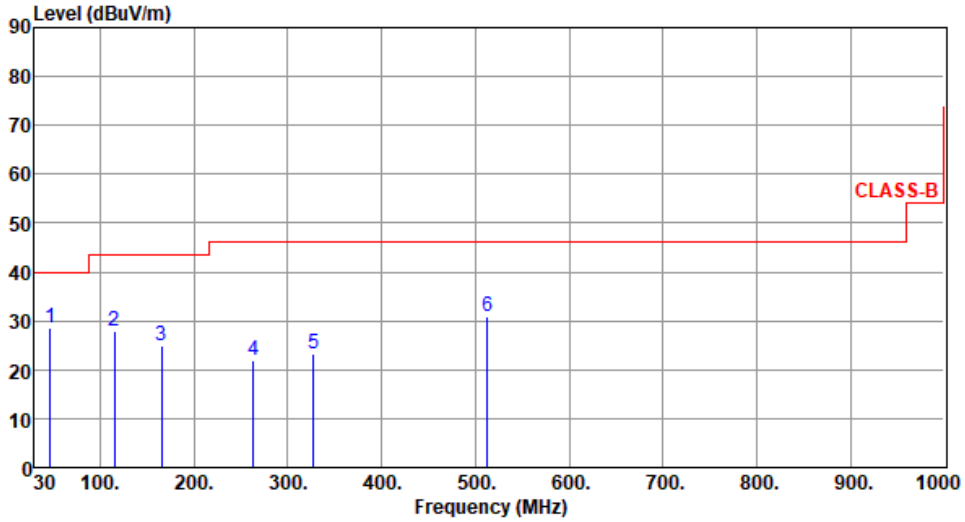

	Freq. MHz	Emission level dBuV/m	Limit dBuV/m	Margin dB	SA reading dBuV	Factor dB/m	Remark	ANT High cm	Turn Table deg
1	46.49	28.56	40.00	-11.44	36.57	-8.01	Peak	---	---
2	115.36	27.75	43.50	-15.75	39.13	-11.38	Peak	---	---
3	165.80	24.79	43.50	-18.71	33.59	-8.80	Peak	---	---
4	263.77	22.05	46.00	-23.95	31.25	-9.20	Peak	---	---
5	327.79	23.31	46.00	-22.69	30.17	-6.86	Peak	---	---
6	513.06	30.75	46.00	-15.25	32.79	-2.04	Peak	---	---

Note 1: Emission Level (dBuV/m) = SA Reading (dBuV) + Factor* (dB/m)

*Factor includes antenna factor , cable loss and amplifier gain

Note 2: Margin (dB) = Emission level (dBuV/m) – Limit (dBuV/m).

Note 3: All spurious emissions below 30MHz are more than 20 dB below the limit.



Mode	Charging mode with laptop									
Polarization	Horizontal									
Test By : Paul Lin			Temperature(°C): 24			Humidity(%): 62				
	Freq.	Emission level	Limit	Margin	SA reading	Factor	Remark	ANT High	Turn Table	
	MHz	dBuV/m	dBuV/m	dB	dBuV	dB/m		cm	deg	
1	112.45	35.57	43.50	-7.93	47.03	-11.46	Peak	---	---	
2	225.94	30.59	46.00	-15.41	42.59	-12.00	Peak	---	---	
3	331.67	30.46	46.00	-15.54	37.25	-6.79	Peak	---	---	
4	364.65	30.39	46.00	-15.61	36.60	-6.21	Peak	---	---	
5	445.16	34.06	46.00	-11.94	37.60	-3.54	Peak	---	---	
6	514.03	31.63	46.00	-14.37	33.67	-2.04	Peak	---	---	

Note 1: Emission Level (dBuV/m) = SA Reading (dBuV) + Factor* (dB/m)

*Factor includes antenna factor , cable loss and amplifier gain

Note 2: Margin (dB) = Emission level (dBuV/m) – Limit (dBuV/m).

Note 3: All spurious emissions below 30MHz are more than 20 dB below the limit.



Mode	Charging mode with laptop									
Polarization	Vertical									
Test By : Paul Lin			Temperature(°C): 24			Humidity(%): 62				
<p>The graph displays the emission level in dBuV/m across a frequency range from 30 MHz to 1000 MHz. A red step function represents the CLASS-B limit, starting at 40 dBuV/m and increasing to 55 dBuV/m at 1000 MHz. Six peaks are identified and numbered 1 through 6, corresponding to the data table below.</p>										
	Freq.	Emission level	Limit	Margin	SA reading	Factor	Remark	ANT High	Turn Table	
	MHz	dBuV/m	dBuV/m	dB	dBuV	dB/m		cm	deg	
1	40.67	30.53	40.00	-9.47	39.15	-8.62	Peak	---	---	
2	111.48	28.33	43.50	-15.17	39.87	-11.54	Peak	---	---	
3	127.00	29.15	43.50	-14.35	39.80	-10.65	Peak	---	---	
4	143.49	28.80	43.50	-14.70	37.49	-8.69	Peak	---	---	
5	236.61	23.93	46.00	-22.07	34.29	-10.36	Peak	---	---	
6	496.57	34.19	46.00	-11.81	36.61	-2.42	Peak	---	---	

Note 1: Emission Level (dBuV/m) = SA Reading (dBuV) + Factor* (dB/m)

*Factor includes antenna factor , cable loss and amplifier gain

Note 2: Margin (dB) = Emission level (dBuV/m) – Limit (dBuV/m).

Note 3: All spurious emissions below 30MHz are more than 20 dB below the limit.



Mode	Charging mode with adapter									
Polarization	Horizontal									
Test By : Paul Lin			Temperature(°C): 24			Humidity(%): 62				
	Freq.	Emission	Limit	Margin	SA	Factor	Remark	ANT	Turn	
	MHz	level	dBuV/m	dB	reading	dB/m		High	Table	
		dBuV/m			dBuV			cm	deg	
1	36.79	23.82	40.00	-16.18	32.81	-8.99	Peak	---	---	
2	54.25	24.73	40.00	-15.27	32.76	-8.03	Peak	---	---	
3	126.03	21.83	43.50	-21.67	32.49	-10.66	Peak	---	---	
4	149.31	22.20	43.50	-21.30	30.71	-8.51	Peak	---	---	
5	280.26	23.32	46.00	-22.68	31.78	-8.46	Peak	---	---	
6	346.22	24.44	46.00	-21.56	31.06	-6.62	Peak	---	---	
<p>Note 1: Emission Level (dBuV/m) = SA Reading (dBuV) + Factor* (dB/m) *Factor includes antenna factor , cable loss and amplifier gain Note 2: Margin (dB) = Emission level (dBuV/m) – Limit (dBuV/m). Note 3: All spurious emissions below 30MHz are more than 20 dB below the limit.</p>										



Mode	Charging mode with adapter									
Polarization	Vertical									
Test By :Paul Lin			Temperature(°C):24			Humidity(%):62				
<p>The graph plots Level (dBuV/m) on the y-axis (0 to 90) against Frequency (MHz) on the x-axis (30 to 1000). A red step-like line represents the CLASS-B emission limit. Six blue vertical lines indicate measured peaks at frequencies 35.82, 51.34, 148.34, 302.57, 382.11, and 428.67 MHz. The emission levels for these peaks are 27.54, 25.91, 25.81, 23.39, 25.15, and 26.58 dBuV/m, respectively. All peaks are well below the CLASS-B limit.</p>										
	Freq.	Emission	Limit	Margin	SA	Factor	Remark	ANT	Turn	
	MHz	level	dBuV/m	dB	reading	dB/m		High	Table	
								cm	deg	
1	35.82	27.54	40.00	-12.46	36.90	-9.36	Peak	---	---	
2	51.34	25.91	40.00	-14.09	33.78	-7.87	Peak	---	---	
3	148.34	25.81	43.50	-17.69	34.45	-8.64	Peak	---	---	
4	302.57	23.39	46.00	-22.61	31.25	-7.86	Peak	---	---	
5	382.11	25.15	46.00	-20.85	30.55	-5.40	Peak	---	---	
6	428.67	26.58	46.00	-19.42	30.65	-4.07	Peak	---	---	

Note 1: Emission Level (dBuV/m) = SA Reading (dBuV) + Factor* (dB/m)
 *Factor includes antenna factor , cable loss and amplifier gain
 Note 2: Margin (dB) = Emission level (dBuV/m) – Limit (dBuV/m).
 Note 3: All spurious emissions below 30MHz are more than 20 dB below the limit.



Unwanted Emissions (Above 1GHz)

Modulation	GFSK	Test Freq. (MHz)	2403
Polarization	Horizontal		

Test By :Brad Wu Temperature(°C):24 Humidity(%):62

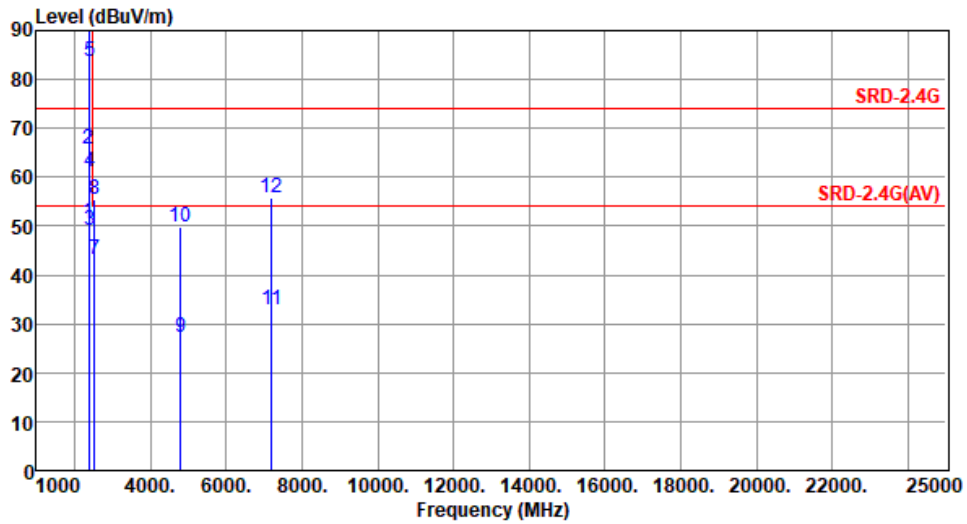

	Freq. MHz	Emission level dBuV/m	Limit dBuV/m	Margin dB	SA reading dBuV	Factor dB/m	Remark	ANT High cm	Turn Table deg
1	2371.00	50.65	54.00	-3.35	52.31	-1.66	Average	104	2
2	2371.00	65.91	74.00	-8.09	67.57	-1.66	Peak	104	2
3	2400.00	49.01	54.00	-4.99	50.81	-1.80	Average	104	2
4	2400.00	61.08	74.00	-12.92	62.88	-1.80	Peak	104	2
5	2403.00	83.58	94.00	-10.42			Average	104	2
6	2403.00	106.21	114.00	-7.79	108.02	-1.81	Peak	104	2
7	2531.00	43.18	54.00	-10.82	45.02	-1.84	Average	104	2
8	2531.00	55.59	74.00	-18.41	57.43	-1.84	Peak	104	2
9	4806.00	27.20	54.00	-26.80			Average	109	43
10	4806.00	49.83	74.00	-24.17	45.06	4.77	Peak	109	43
11	7209.00	33.00	54.00	-21.00			Average	100	203
12	7209.00	55.63	74.00	-18.37	44.84	10.79	Peak	100	203

Note 1: Emission Level (dBuV/m) = SA Reading (dBuV) + Factor* (dB/m)

*Factor includes antenna factor , cable loss and amplifier gain

Note 2: Margin (dB) = Emission level (dBuV/m) – Limit (dBuV/m).

Note 3: When average value is calculated not measured, no SA reading and factor value are listed.



Modulation	GFSK	Test Freq. (MHz)	2403
Polarization	Vertical		

Test By :Brad Wu Temperature(°C):24 Humidity(%):62

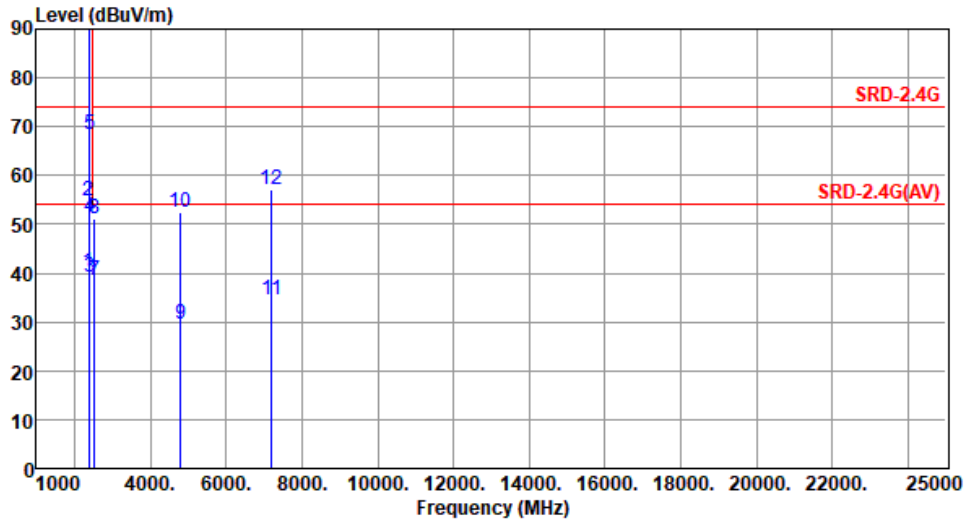

	Freq. MHz	Emission level dBuV/m	Limit dBuV/m	Margin dB	SA reading dBuV	Factor dB/m	Remark	ANT High cm	Turn Table deg
1	2371.00	40.22	54.00	-13.78	41.88	-1.66	Average	316	295
2	2371.00	54.86	74.00	-19.14	56.52	-1.66	Peak	316	295
3	2400.00	39.22	54.00	-14.78	41.02	-1.80	Average	316	295
4	2400.00	51.51	74.00	-22.49	53.31	-1.80	Peak	316	295
5	2403.00	68.51	94.00	-25.49			Average	316	295
6	2403.00	91.14	114.00	-22.86	92.95	-1.81	Peak	316	295
7	2531.00	38.45	54.00	-15.55	40.29	-1.84	Average	316	295
8	2531.00	51.19	74.00	-22.81	53.03	-1.84	Peak	316	295
9	4806.00	29.70	54.00	-24.30			Average	289	26
10	4806.00	52.33	74.00	-21.67	47.56	4.77	Peak	289	26
11	7209.00	34.59	54.00	-19.41			Average	100	165
12	7209.00	57.22	74.00	-16.78	46.43	10.79	Peak	100	165

Note 1: Emission Level (dBuV/m) = SA Reading (dBuV) + Factor* (dB/m)
 *Factor includes antenna factor , cable loss and amplifier gain
 Note 2: Margin (dB) = Emission level (dBuV/m) – Limit (dBuV/m).
 Note 3: When average value is calculated not measured, no SA reading and factor value are listed.



Modulation	GFSK	Test Freq. (MHz)	2441
Polarization	Horizontal		

Test By :Brad Wu Temperature(°C):24 Humidity(%):62

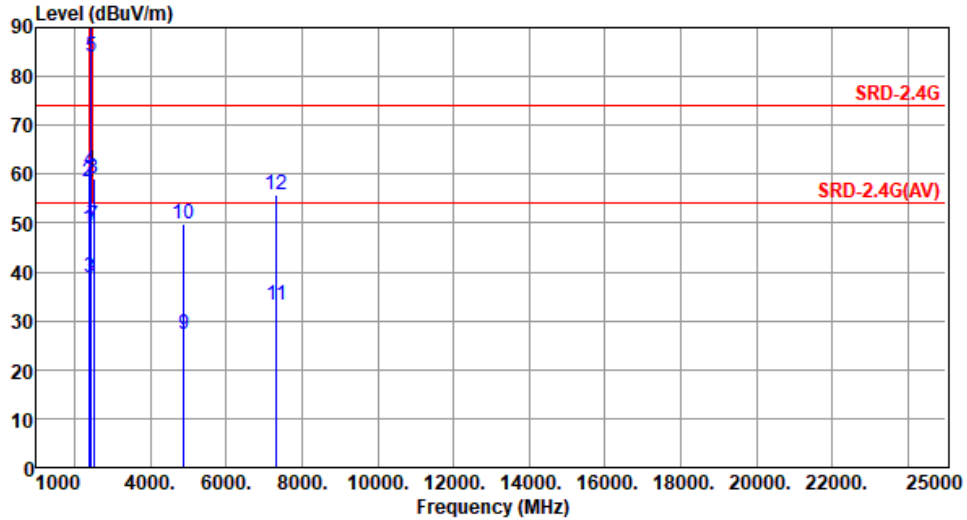

	Freq. MHz	Emission level dBuV/m	Limit dBuV/m	Margin dB	SA reading dBuV	Factor dB/m	Remark	ANT High cm	Turn Table deg
1	2377.00	48.85	54.00	-5.15	50.54	-1.69	Average	100	5
2	2377.00	58.58	74.00	-15.42	60.27	-1.69	Peak	100	5
3	2400.00	38.95	54.00	-15.05	40.75	-1.80	Average	100	5
4	2400.00	60.69	74.00	-13.31	62.49	-1.80	Peak	100	5
5	2441.00	83.98	94.00	-10.02			Average	100	5
6	2441.00	106.61	114.00	-7.39	108.46	-1.85	Peak	100	5
7	2505.00	49.43	54.00	-4.57	51.33	-1.90	Average	100	5
8	2505.00	59.28	74.00	-14.72	61.18	-1.90	Peak	100	5
9	4882.00	27.33	54.00	-26.67			Average	110	45
10	4882.00	49.96	74.00	-24.04	45.05	4.91	Peak	110	45
11	7323.00	33.19	54.00	-20.81			Average	100	206
12	7323.00	55.82	74.00	-18.18	45.03	10.79	Peak	100	206

Note 1: Emission Level (dBuV/m) = SA Reading (dBuV) + Factor* (dB/m)
 *Factor includes antenna factor , cable loss and amplifier gain
 Note 2: Margin (dB) = Emission level (dBuV/m) – Limit (dBuV/m).
 Note 3: When average value is calculated not measured, no SA reading and factor value are listed.



Modulation	GFSK	Test Freq. (MHz)	2441
Polarization	Vertical		

Test By :Brad Wu Temperature(°C):24 Humidity(%):62

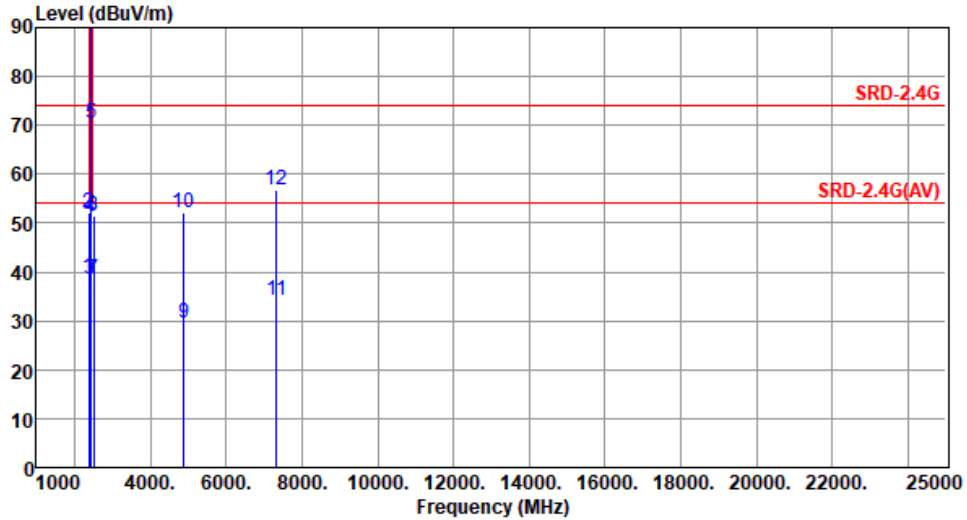

	Freq. MHz	Emission level dBuV/m	Limit dBuV/m	Margin dB	SA reading dBuV	Factor dB/m	Remark	ANT High cm	Turn Table deg
1	2377.00	38.87	54.00	-15.13	40.56	-1.69	Average	314	271
2	2377.00	52.17	74.00	-21.83	53.86	-1.69	Peak	314	271
3	2400.00	38.39	54.00	-15.61	40.19	-1.80	Average	314	271
4	2400.00	51.24	74.00	-22.76	53.04	-1.80	Peak	314	271
5	2441.00	70.35	94.00	-23.65			Average	314	271
6	2441.00	92.98	114.00	-21.02	94.83	-1.85	Peak	314	271
7	2505.00	38.54	54.00	-15.46	40.44	-1.90	Average	314	271
8	2505.00	51.57	74.00	-22.43	53.47	-1.90	Peak	314	271
9	4882.00	29.44	54.00	-24.56			Average	299	38
10	4882.00	52.07	74.00	-21.93	47.16	4.91	Peak	299	38
11	7323.00	34.32	54.00	-19.68			Average	100	168
12	7323.00	56.95	74.00	-17.05	46.16	10.79	Peak	100	168

Note 1: Emission Level (dBuV/m) = SA Reading (dBuV) + Factor* (dB/m)
 *Factor includes antenna factor , cable loss and amplifier gain
 Note 2: Margin (dB) = Emission level (dBuV/m) – Limit (dBuV/m).
 Note 3: When average value is calculated not measured, no SA reading and factor value are listed.



Modulation	GFSK	Test Freq. (MHz)	2481
Polarization	Horizontal		

Test By :Brad Wu Temperature(°C):24 Humidity(%):62

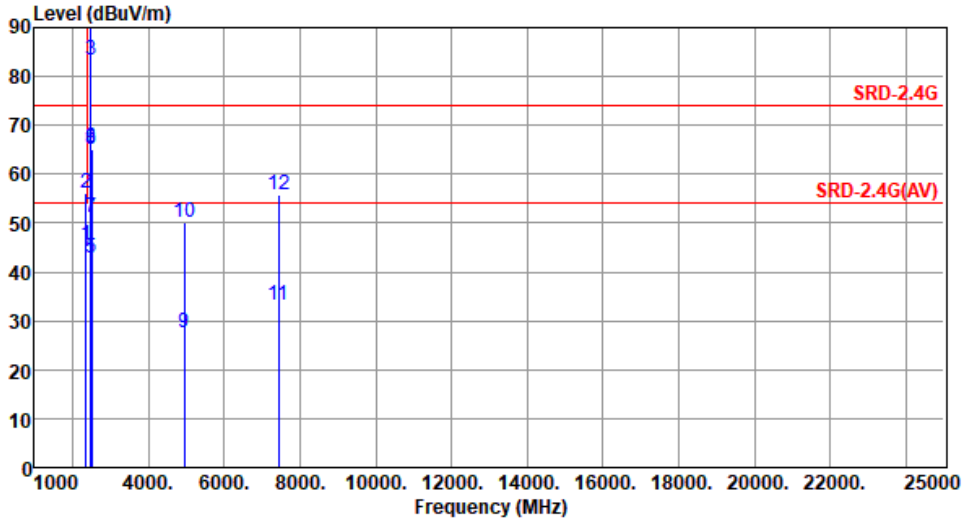

	Freq. MHz	Emission level dBuV/m	Limit dBuV/m	Margin dB	SA reading dBuV	Factor dB/m	Remark	ANT High cm	Turn Table deg
1	2353.00	45.60	54.00	-8.40	47.17	-1.57	Average	100	356
2	2353.00	55.99	74.00	-18.01	57.56	-1.57	Peak	100	356
3	2481.00	83.39	94.00	-10.61			Average	100	356
4	2481.00	106.02	114.00	-7.98	107.91	-1.89	Peak	100	356
5	2483.50	42.69	54.00	-11.31			Average	100	356
6	2483.50	65.32	74.00	-8.68	67.22	-1.90	Peak	100	356
7	2512.00	50.99	54.00	-3.01	52.88	-1.89	Average	100	356
8	2512.00	65.23	74.00	-8.77	67.12	-1.89	Peak	100	356
9	4962.00	27.45	54.00	-26.55			Average	105	52
10	4962.00	50.08	74.00	-23.92	45.01	5.07	Peak	105	52
11	7443.00	33.15	54.00	-20.85			Average	100	198
12	7443.00	55.78	74.00	-18.22	44.89	10.89	Peak	100	198

Note 1: Emission Level (dBuV/m) = SA Reading (dBuV) + Factor* (dB/m)
 *Factor includes antenna factor , cable loss and amplifier gain
 Note 2: Margin (dB) = Emission level (dBuV/m) – Limit (dBuV/m).
 Note 3: When average value is calculated not measured, no SA reading and factor value are listed.



Modulation	GFSK	Test Freq. (MHz)	2481
Polarization	Vertical		

Test By :Brad Wu Temperature(°C):24 Humidity(%):62

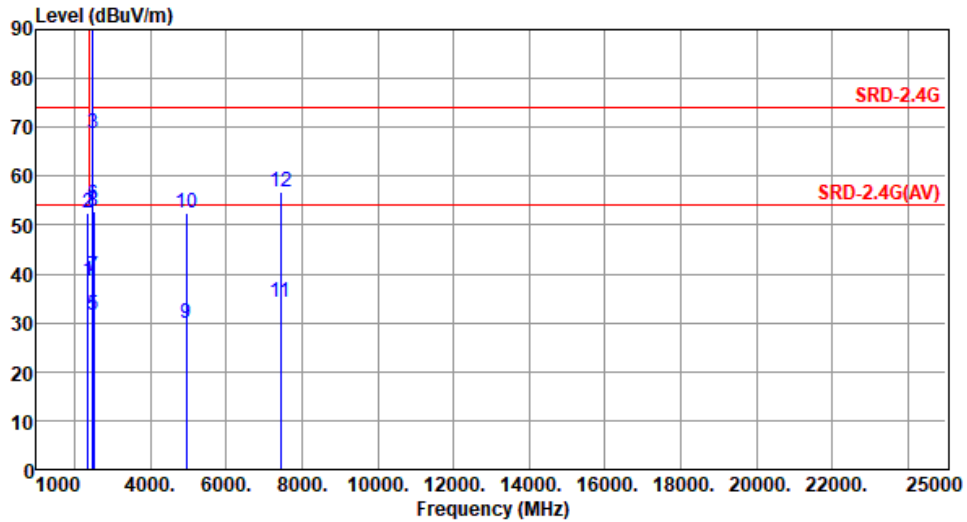

	Freq. MHz	Emission level dBuV/m	Limit dBuV/m	Margin dB	SA reading dBuV	Factor dB/m	Remark	ANT High cm	Turn Table deg
1	2353.00	38.67	54.00	-15.33	40.24	-1.57	Average	305	259
2	2353.00	52.45	74.00	-21.55	54.02	-1.57	Peak	305	259
3	2481.00	68.73	94.00	-25.27			Average	305	259
4	2481.00	91.36	114.00	-22.64	93.25	-1.89	Peak	305	259
5	2483.50	31.63	54.00	-22.37			Average	305	259
6	2483.50	54.26	74.00	-19.74	56.16	-1.90	Peak	305	259
7	2512.00	39.58	54.00	-14.42	41.47	-1.89	Average	305	259
8	2512.00	52.75	74.00	-21.25	54.64	-1.89	Peak	305	259
9	4962.00	29.73	54.00	-24.27			Average	299	32
10	4962.00	52.36	74.00	-21.64	47.29	5.07	Peak	299	32
11	7443.00	34.05	54.00	-19.95			Average	100	166
12	7443.00	56.68	74.00	-17.32	45.79	10.89	Peak	100	166

Note 1: Emission Level (dBuV/m) = SA Reading (dBuV) + Factor* (dB/m)
 *Factor includes antenna factor , cable loss and amplifier gain
 Note 2: Margin (dB) = Emission level (dBuV/m) – Limit (dBuV/m).
 Note 3: When average value is calculated not measured, no SA reading and factor value are listed.

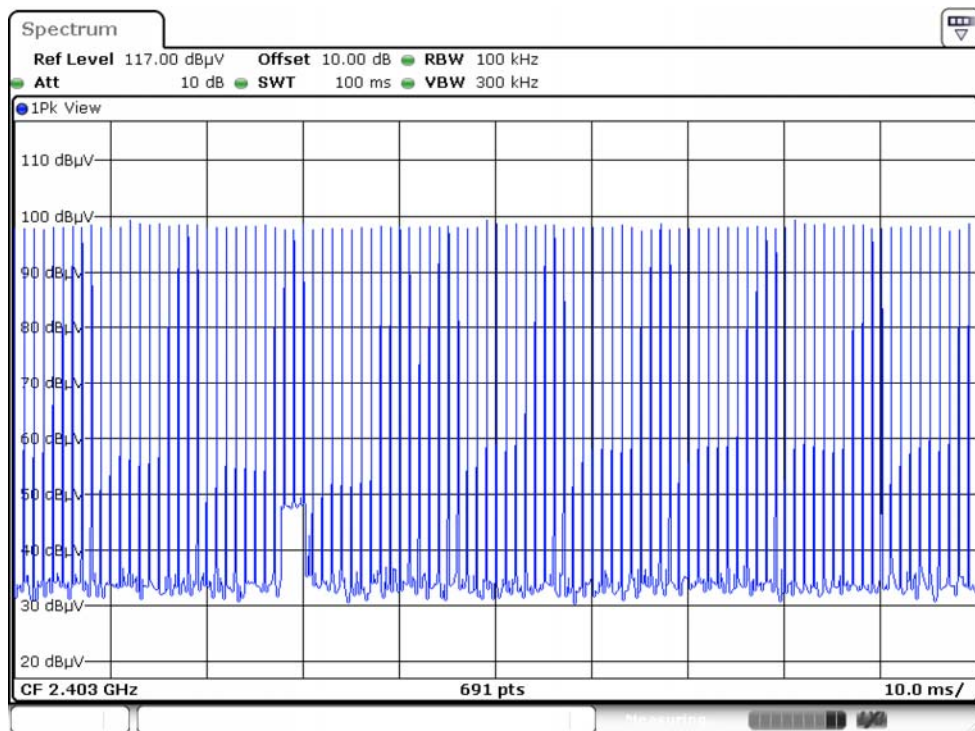
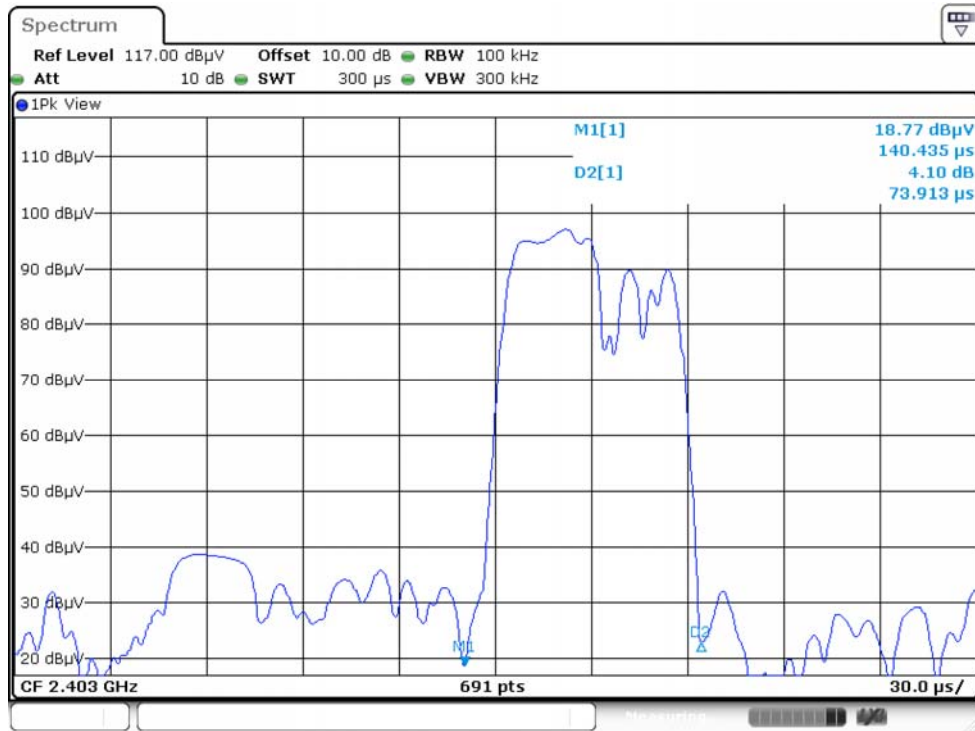

$$20\log(\text{Duty cycle}) = 20\log \frac{0.073913 \times 100 \text{ ms}}{100 \text{ ms}} = -22.63\text{dB}$$



Frequency (MHz)	20dB Bandwidth (MHz)	99% Occupied Bandwidth (MHz)
2403	1.874	1.816
2441	1.874	1.816
2481	1.867	1.787

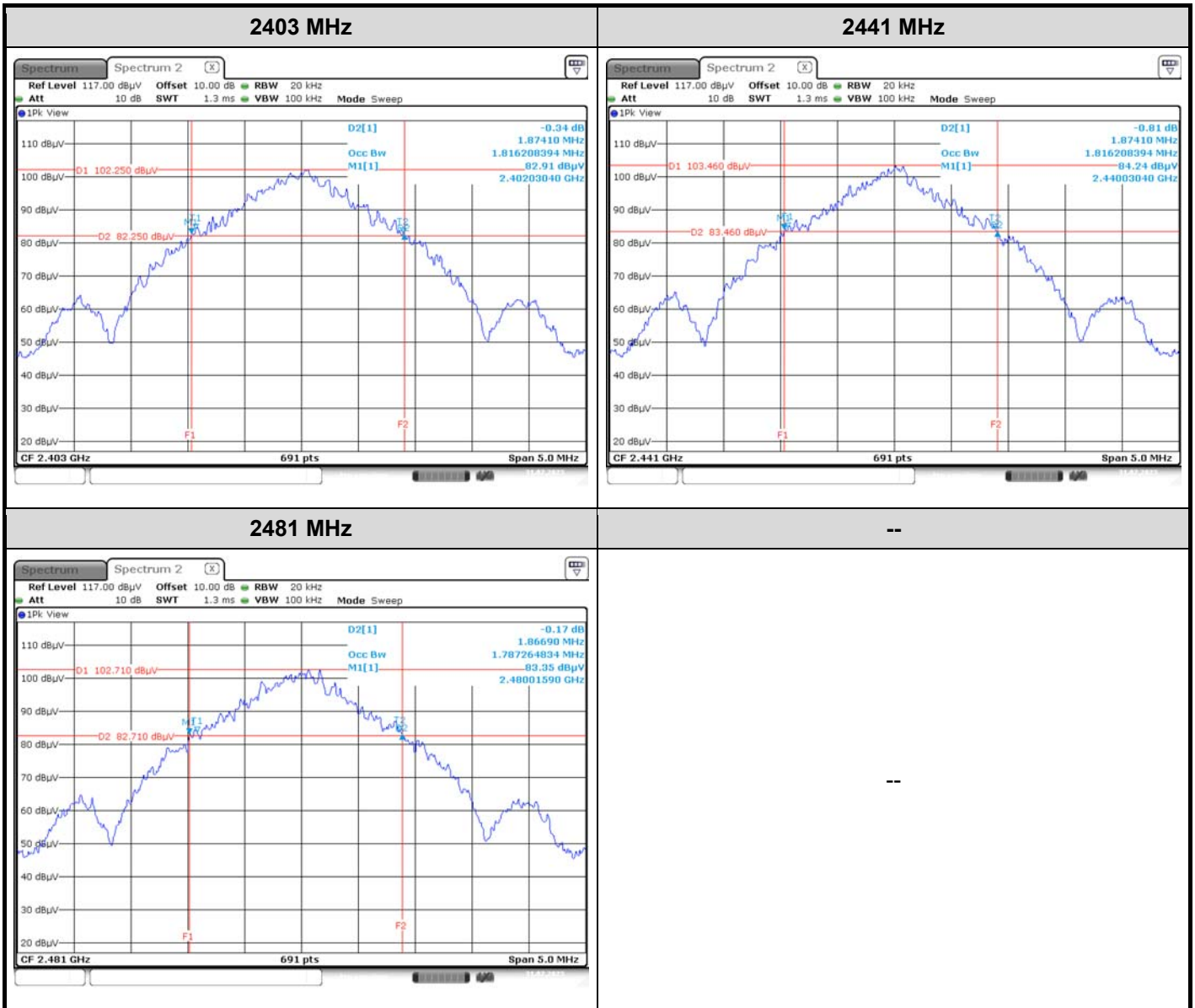



Modulation Mode	GFSK	Test Freq. (MHz)	2441
Power Phase	Line		

Test by : Wish Yu Temperature: 23°C Humidity: 63%

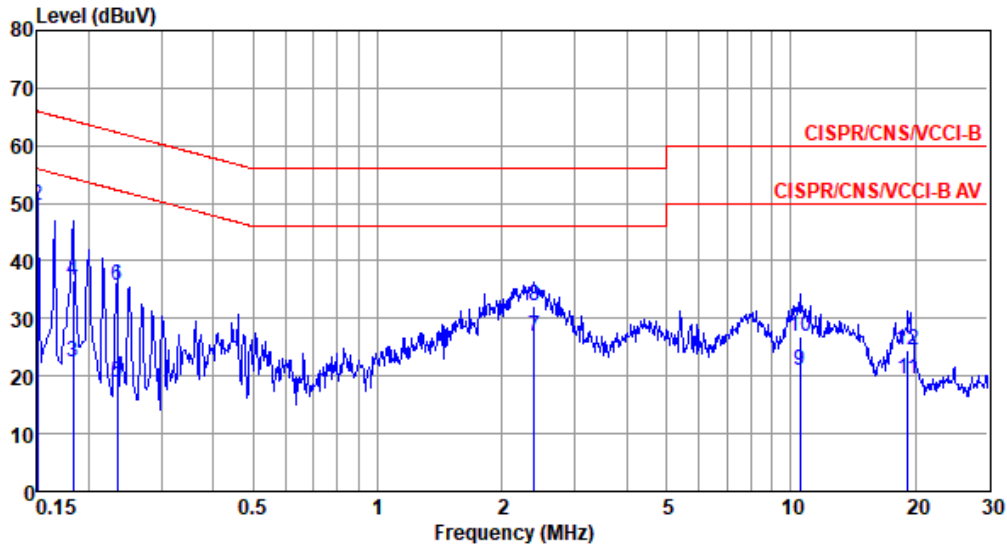

	Freq MHz	Level dBuV	Limit Line dBuV	Over Limit dB	Read Level dBuV	Factor dB	Cable loss dB	Aux dB	Remark
1	0.150	34.97	56.00	-21.03	25.10	9.63	0.06	0.18	Average
2*	0.150	49.62	66.00	-16.38	39.75	9.63	0.06	0.18	QP
3	0.183	22.51	54.33	-31.82	12.64	9.62	0.06	0.19	Average
4	0.183	36.57	64.33	-27.76	26.70	9.62	0.06	0.19	QP
5	0.234	18.90	52.30	-33.40	9.01	9.62	0.06	0.21	Average
6	0.234	35.72	62.30	-26.58	25.83	9.62	0.06	0.21	QP
7	2.396	26.86	46.00	-19.14	16.70	9.64	0.14	0.38	Average
8	2.396	32.16	56.00	-23.84	22.00	9.64	0.14	0.38	QP
9	10.508	21.03	50.00	-28.97	10.52	9.69	0.37	0.45	Average
10	10.508	26.86	60.00	-33.14	16.35	9.69	0.37	0.45	QP
11	19.224	19.40	50.00	-30.60	8.70	9.68	0.50	0.52	Average
12	19.224	24.45	60.00	-35.55	13.75	9.68	0.50	0.52	QP

Note 1: Level (dBuV) = Read Level (dBuV) + LISN Factor (dB) + Cable Loss (dB) + Aux (dB).
 Note 2: Over Limit (dB) = Level (dBuV) – Limit Line (dBuV).



Modulation Mode	GFSK	Test Freq. (MHz)	2441
Power Phase	Neutral		

Test by : Wish Yu Temperature: 23°C Humidity: 63%

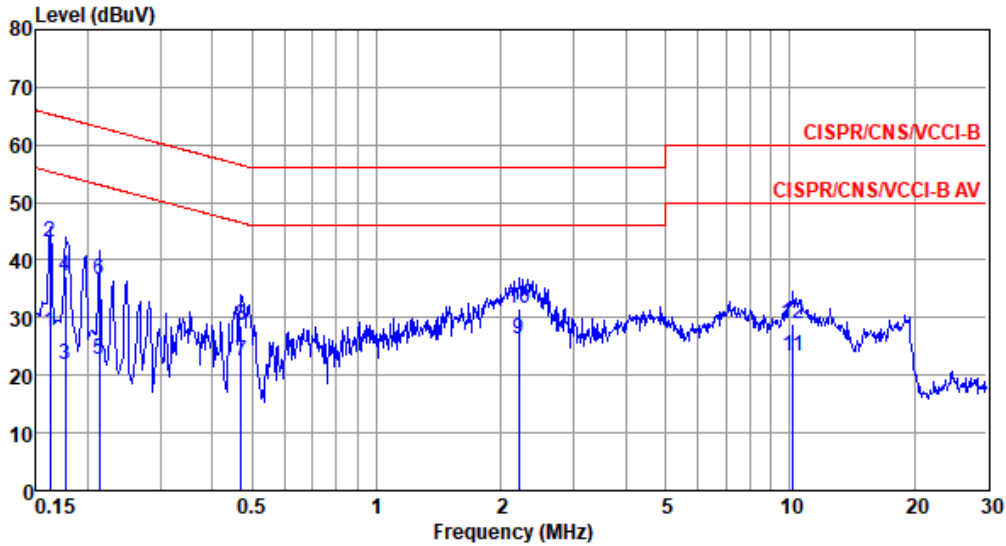

	Freq MHz	Level dBuV	Limit Line dBuV	Over Limit dB	Read Level dBuV	Factor dB	Cable loss dB	Aux dB	Remark
1	0.162	27.39	55.34	-27.95	17.70	9.63	0.06	0.00	Average
2	0.162	43.22	65.34	-22.12	33.53	9.63	0.06	0.00	QP
3	0.177	21.99	54.64	-32.65	12.30	9.63	0.06	0.00	Average
4	0.177	37.30	64.64	-27.34	27.61	9.63	0.06	0.00	QP
5	0.213	22.65	53.10	-30.45	12.96	9.63	0.06	0.00	Average
6	0.213	36.58	63.10	-26.52	26.89	9.63	0.06	0.00	QP
7	0.471	22.36	46.49	-24.13	12.67	9.62	0.07	0.00	Average
8	0.471	28.73	56.49	-27.76	19.04	9.62	0.07	0.00	QP
9*	2.213	26.21	46.00	-19.79	16.43	9.64	0.14	0.00	Average
10	2.213	31.69	56.00	-24.31	21.91	9.64	0.14	0.00	QP
11	10.179	23.38	50.00	-26.62	13.31	9.71	0.36	0.00	Average
12	10.179	28.97	60.00	-31.03	18.90	9.71	0.36	0.00	QP

Note 1: Level (dBuV) = Read Level (dBuV) + LISN Factor (dB) + Cable Loss (dB) + Aux (dB).
 Note 2: Over Limit (dB) = Level (dBuV) – Limit Line (dBuV).



Mode	Charging mode with laptop
Power Phase	Line

Test by : Wish Yu Temperature: 23°C Humidity: 63%

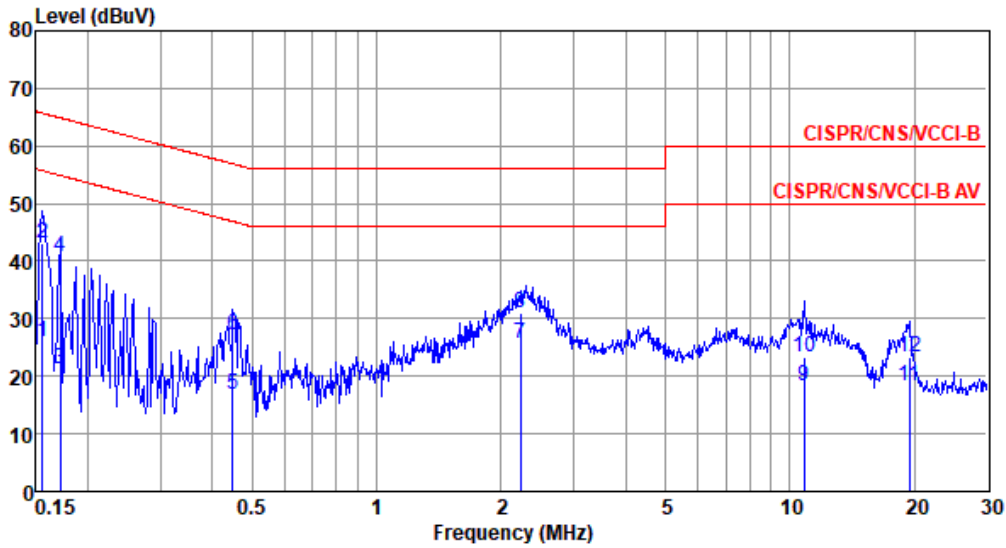

	Freq MHz	Level dBuV	Limit Line dBuV	Over Limit dB	Read Level dBuV	Factor dB	Cable loss dB	Aux dB	Remark
1	0.156	25.91	55.69	-29.78	16.22	9.63	0.06	0.00	Average
2	0.156	42.99	65.69	-22.70	33.30	9.63	0.06	0.00	QP
3	0.171	21.38	54.90	-33.52	11.69	9.63	0.06	0.00	Average
4	0.171	40.88	64.90	-24.02	31.19	9.63	0.06	0.00	QP
5	0.449	16.91	46.89	-29.98	7.22	9.62	0.07	0.00	Average
6	0.449	27.24	56.89	-29.65	17.55	9.62	0.07	0.00	QP
7*	2.225	25.70	46.00	-20.30	15.93	9.63	0.14	0.00	Average
8	2.225	30.85	56.00	-25.15	21.08	9.63	0.14	0.00	QP
9	10.847	18.38	50.00	-31.62	8.31	9.69	0.38	0.00	Average
10	10.847	23.27	60.00	-36.73	13.20	9.69	0.38	0.00	QP
11	19.428	18.26	50.00	-31.74	8.08	9.68	0.50	0.00	Average
12	19.428	23.43	60.00	-36.57	13.25	9.68	0.50	0.00	QP

Note 1: Level (dBuV) = Read Level (dBuV) + LISN Factor (dB) + Cable Loss (dB) + Aux (dB).
 Note 2: Over Limit (dB) = Level (dBuV) - Limit Line (dBuV).



Mode	Charging mode with laptop
Power Phase	Neutral

Test by : Wish Yu Temperature: 23°C Humidity: 63%

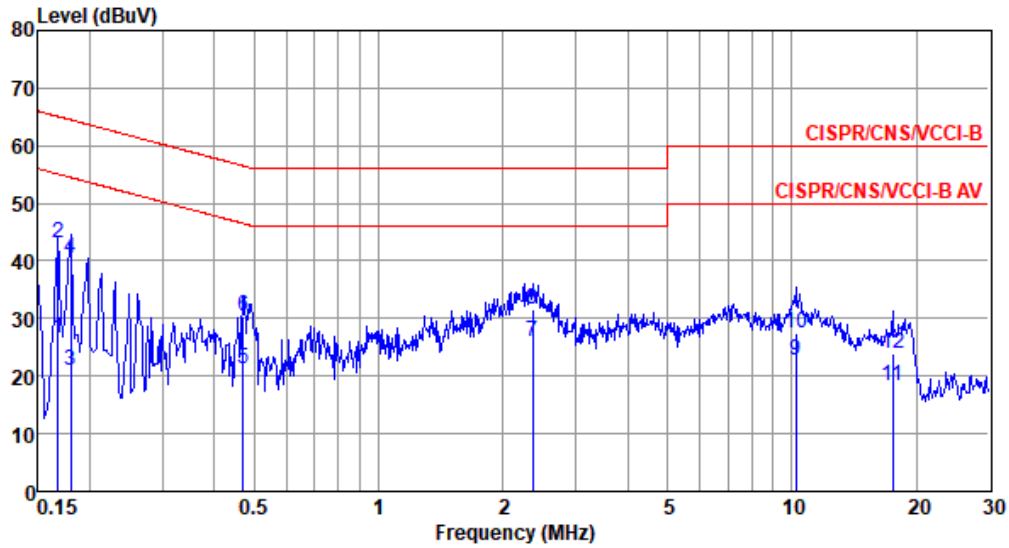

	Freq MHz	Level dBuV	Limit Line dBuV	Over Limit dB	Read Level dBuV	Factor dB	Cable loss dB	Aux dB	Remark
1	0.168	26.50	55.08	-28.58	16.81	9.63	0.06	0.00	Average
2	0.168	43.01	65.08	-22.07	33.32	9.63	0.06	0.00	QP
3	0.180	21.01	54.50	-33.49	11.32	9.63	0.06	0.00	Average
4	0.180	40.55	64.50	-23.95	30.86	9.63	0.06	0.00	QP
5	0.471	21.37	46.49	-25.12	11.68	9.62	0.07	0.00	Average
6	0.471	30.47	56.49	-26.02	20.78	9.62	0.07	0.00	QP
7*	2.358	25.83	46.00	-20.17	16.05	9.64	0.14	0.00	Average
8	2.358	31.50	56.00	-24.50	21.72	9.64	0.14	0.00	QP
9	10.233	22.84	50.00	-27.16	12.77	9.71	0.36	0.00	Average
10	10.233	27.59	60.00	-32.41	17.52	9.71	0.36	0.00	QP
11	17.568	18.28	50.00	-31.72	8.02	9.78	0.48	0.00	Average
12	17.568	23.89	60.00	-36.11	13.63	9.78	0.48	0.00	QP

Note 1: Level (dBuV) = Read Level (dBuV) + LISN Factor (dB) + Cable Loss (dB) + Aux (dB).
 2: Over Limit (dB) = Level (dBuV) – Limit Line (dBuV).



Mode	Charging mode with adapter
Power Phase	Line

Test by : Wish Yu Temperature: 23°C Humidity: 63%

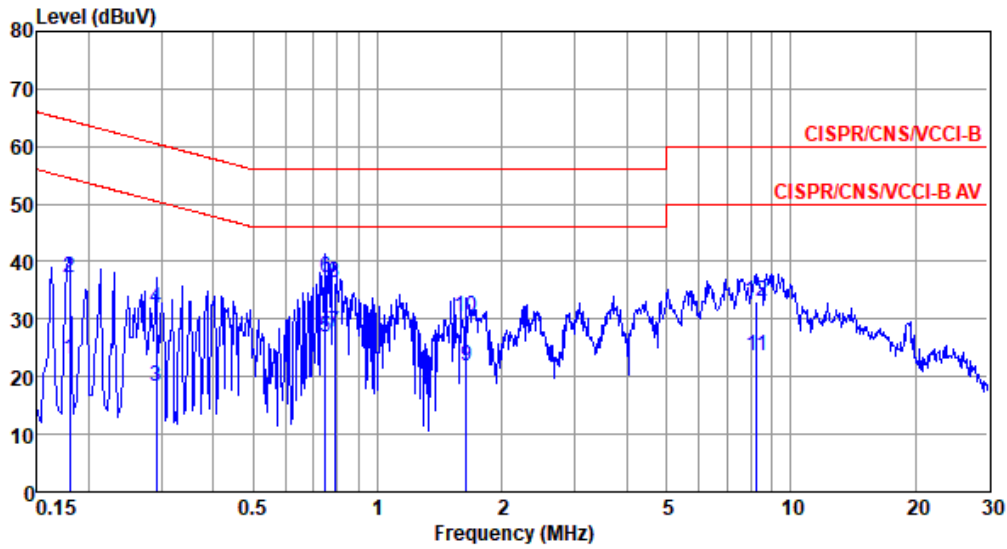

	Freq MHz	Level dBuV	Limit Line dBuV	Over Limit dB	Read Level dBuV	Factor dB	Cable loss dB	Aux dB	Remark
1	0.180	23.12	54.50	-31.38	13.25	9.62	0.06	0.19	Average
2	0.180	37.12	64.50	-27.38	27.25	9.62	0.06	0.19	QP
3	0.291	18.31	50.50	-32.19	8.38	9.62	0.06	0.25	Average
4	0.291	31.84	60.50	-28.66	21.91	9.62	0.06	0.25	QP
5	0.747	26.99	46.00	-19.01	16.95	9.63	0.09	0.32	Average
6	0.747	37.06	56.00	-18.94	27.02	9.63	0.09	0.32	QP
7*	0.788	27.66	46.00	-18.34	17.61	9.63	0.10	0.32	Average
8	0.788	36.45	56.00	-19.55	26.40	9.63	0.10	0.32	QP
9	1.636	21.80	46.00	-24.20	11.70	9.63	0.12	0.35	Average
10	1.636	30.38	56.00	-25.62	20.28	9.63	0.12	0.35	QP
11	8.279	23.57	50.00	-26.43	13.13	9.68	0.32	0.44	Average
12	8.279	33.13	60.00	-26.87	22.69	9.68	0.32	0.44	QP

Note 1: Level (dBuV) = Read Level (dBuV) + LISN Factor (dB) + Cable Loss (dB) + Aux (dB).
 2: Over Limit (dB) = Level (dBuV) - Limit Line (dBuV).



Mode	Charging mode with adapter
Power Phase	Neutral

Test by : Wish Yu Temperature: 23°C Humidity: 63%

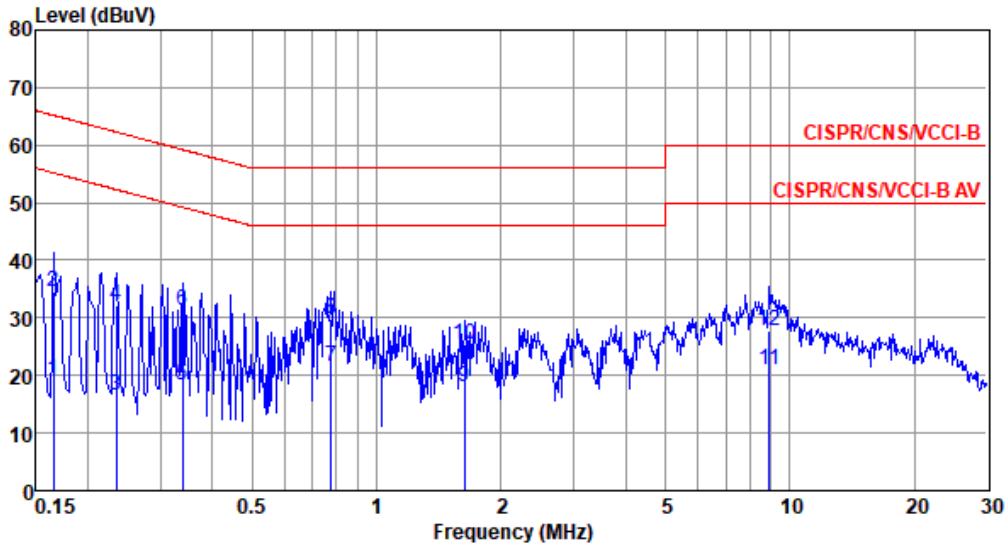

	Freq	Level	Limit	Over	Read	Factor	Cable	Aux	Remark
	MHz	dBuV	Line	Limit	Level	dB	loss	dB	
			dBuV	dB	dBuV		dB	dB	
1	0.165	19.06	55.21	-36.15	9.19	9.63	0.06	0.18	Average
2	0.165	34.42	65.21	-30.79	24.55	9.63	0.06	0.18	QP
3	0.234	16.43	52.30	-35.87	6.53	9.63	0.06	0.21	Average
4	0.234	32.22	62.30	-30.08	22.32	9.63	0.06	0.21	QP
5	0.339	18.26	49.22	-30.96	8.31	9.62	0.06	0.27	Average
6	0.339	31.40	59.22	-27.82	21.45	9.62	0.06	0.27	QP
7*	0.775	21.49	46.00	-24.51	11.44	9.63	0.10	0.32	Average
8	0.775	29.92	56.00	-26.08	19.87	9.63	0.10	0.32	QP
9	1.628	18.11	46.00	-27.89	8.00	9.64	0.12	0.35	Average
10	1.628	25.50	56.00	-30.50	15.39	9.64	0.12	0.35	QP
11	8.916	20.91	50.00	-29.09	10.43	9.70	0.34	0.44	Average
12	8.916	27.71	60.00	-32.29	17.23	9.70	0.34	0.44	QP

Note 1: Level (dBuV) = Read Level (dBuV) + LISN Factor (dB) + Cable Loss (dB) + Aux (dB).
 Note 2: Over Limit (dB) = Level (dBuV) - Limit Line (dBuV).