

Installation and Operation Guide

DMR Repeater

For SBR8000 / SCR8000 / SER8000

sepura

Going further in critical communications

General

This guide contains the installation and basic operating instructions for the DMR Repeater models SBR8000, SCR8000 and SER8000. This guide does not contain information relating to the installation of accessories such as the antenna and duplexer. Refer to the installation instructions supplied with these accessories for further safety and installation instructions.

Disclaimer notice

Sepura's policy is to continually improve its products. The features and facilities described in this document were correct at publication, but are subject to change without notice.

Contact Us

Sepura plc.
Radio House,
St Andrew's Road,
Cambridge CB4 1GR
United Kingdom
Tel: +44 (0)1223 876000
Fax: +44 (0)1223 879000

sepura

© Sepura plc. 2014

SPR-DOC-03800/2

Original Instructions: ENGLISH

All rights reserved. This document is intended for the use of Sepura plc's customers and/or other parties only for the purposes of the agreement or arrangement under which this document is submitted, and no part of it may be reproduced or transmitted in any form or means without the prior written permission of Sepura plc.

Contents

Safety	2
Regulatory	3
Repeater technical specifications.....	4
Duplexer technical specifications.....	5
Controls, connectors and components	7
Status indicators	7
Unpacking	8
Accessory information.....	8
Installation	8
Connections.....	10
Basic operation.....	11
Configuring the Repeater	12
Caring for your product.....	12

Safety

Read these safety instructions carefully.

Attention!

Sepura products are intended for use in occupational/controlled conditions.

It is the responsibility of the person operating the product to ensure that it is operated safely at all times, and that local laws and regulations governing the usage of Radio Frequency (RF) products are observed. Obey all signs and instructions relating to the usage to RF wireless devices.

It is recommended that you obtain training on how to safely operate this product. Your personal safety could be affected if you do not understand how to operate this product correctly.

This product must not be operated in environments that exceed those listed in the product technical datasheet and in the Regulatory section of the product user guide.

Unauthorised modifications to the product could cause the product to become non-operational. Always use Sepura approved antenna, battery and accessories with this product.

Exposure to RF energy

Sepura designs and manufactures products to meet strict guidelines and international standards relating to Radio Frequency (RF) energy and the potential health risks associated with using such products. If you have any concerns about potential health risks associated with long term exposure to RF energy, you should obtain advice from your employer.

RF energy interference with electronic equipment

Some personal medical devices, such as hearing aids and pacemakers, can be affected by RF energy. Always consult your service provider or the manufacturer of the medical device before using RF wireless devices.

Important safety notes about the Antenna

NEVER touch the antenna when the repeater is transmitting, this may cause a minor burn to the skin and may affect the operational range of the antenna.

NEVER use your repeater without an antenna attached. Transmitting without an antenna may damage the product. Only use a Sepura approved antenna with your repeater.

The antenna must be installed and operated with a minimum distance of 1.2m to any person. This distance has been calculated based on a 2dB cable loss between radio and antenna.

Accessories

Sepura products have been tested to meet strict guidelines for personal safety and operational conditions. Only accessories approved by Sepura are recommended for use with this product. Always read the instructions supplied with the accessory for additional safety instructions.

The use of non-approved accessories may invalidate any product warranty. If a non-approved accessory is fitted, it may compromise the product safety ratings.

Safe installation

CAUTION! This product has double pole/neutral fusing.

Servicing

Do not attempt to dismantle this product. Servicing and repairs to this product must be performed by trained service technicians at Sepura approved service centres

Regulatory



Sepura declares that this product is compliant with the essential requirements and other relevant provisions of the European R&TTE directive 1999/5/EC relating to radio and

telecommunications terminal equipment and the mutual recognition of their conformity. This product is also compliant with directive 2011/65/EU having been designed and manufactured to the RoHS requirements.

Waste Electrical and Electronic Equipment recycling



This symbol on the product or its packaging indicates that this product must not be disposed of as household or commercial waste. Some countries have set up collection and recycling systems for waste electrical and electronic products. By ensuring that

this product and its packaging is disposed of correctly, you will help prevent potentially negative consequences for the environment and human health, and help conserve natural resources. Please dispose of your waste product according to your national and local regulations. Contact your service provider or Sepura for information about disposing of this product in your region of the world.

US and Canadian Markets

FCC radiation exposure statement

This radio is intended for use in occupational/controlled applications where users have been made aware of the potential for exposure and can exercise control over their exposure. This radio device is NOT authorized for general population, consumer or similar use. The antenna should be installed and operated with a minimum distance of 1.2m to any person.

This transmitter must not be co-located or operating in conjunction with any other antenna or transmitter.

IC RSS warning

The term "IC:" before the certification/registration number only signifies that the Industry Canada technical specifications were met.

Le terme "IC:" devant le numéro de certification / enregistrement signifie seulement que les spécifications techniques d'Industrie Canada ont été respectées.

Nominal antenna port impedance / Impédance nominale
antenne Port 50 Ω

Nominal Ethernet port impedance / Impédance nominale
Ethernet port 100 Ω

Ethernet port type / Type d'Ethernet port 100 Base T

IC radiation exposure statement

This radio is intended for use in occupational/controlled applications where users have been made aware of the potential for exposure and can exercise control over their exposure. This radio device is NOT authorized for general population, consumer or similar use.. This transmitter must not be co-

located or operating in conjunction with any other antenna or transmitter.

The antenna should be installed and operated with a minimum distance of 1.2m to any person.

Cette radio a été conçue pour un usage professionnel dans un environnement contrôlé, où les utilisateurs sont pleinement conscients du danger potentiel de l'exposition à laquelle ils sont soumis et peuvent exercer un contrôle sur cette exposition. Ce dispositif radio N'EST PAS autorisé pour l'ensemble de la population, les consommateurs en général, ni pour une utilisation similaire. Cet émetteur ne doit pas être co-localisés ou fonctionner en conjonction avec une autre antenne ou émetteur.

L'antenne doit être installé et utilisé avec un minimum de 1.2m de distance de toute personne.

Repeater technical specifications

Frequency Range:

VHF..... 136-174 MHz

UHF 400-470 MHz

Dimensions (WxDxH)..... 482.5 x 338.5 x 132.5 mm (3U)

Weight 12.5 Kg

Power Supply AC..... 100-120V@2.5A 50/60 Hz
200-240V@1.5A 50/60 Hz

Power Supply DC..... 10.8 – 15.6V@15A

DC Fuse 13.6V15A

AC Fuse 2.5A 250V AC, 5x20mm

Fuse Type HRC ceramic, Time lag (T)

Power Rating..... 240W

Working temperature range..... -30 to 60°C (-22 to 140°F)

Transmitter Power Output:

25W/40W 400-470 MHz

25W/45W 136-174 MHz

For more technical information about this product, refer to the product technical datasheet available from our website.

Duplexer technical specifications

An optional duplexer can be used with the repeater. The duplexer allows the repeater's receiver and transmitter to operate on a single antenna at the same time. When operating within neighbourhoods where other RF devices are installed, including broadcast antennas and microwave link transmitters, the duplexer prevents interference with other RF devices.

The duplexer must comply with these recommended technical specifications.

Frequency Range:

VHF	136-174 MHz
UHF	400-470MHz
Bandwidth	± 400KHz
Insertion Loss	<1.0dB
Isolation.....	>80dB
Suppression	>80dB
V.S.W.R	<1.3
Nominal Impedance	50Ω
Max. power Input	50W

Front Panel

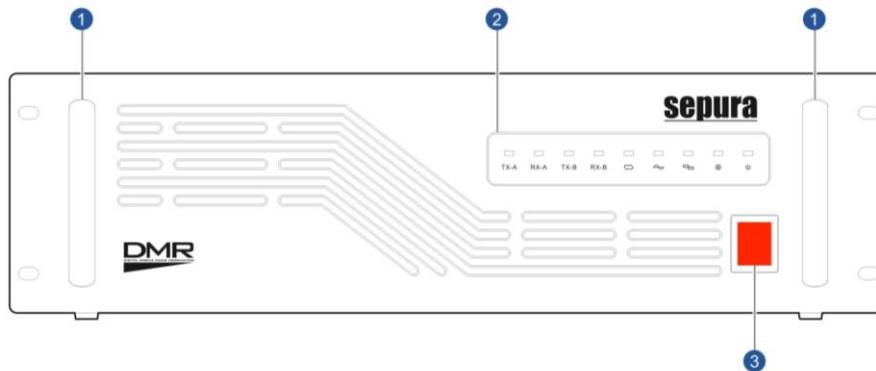

Rear Panel

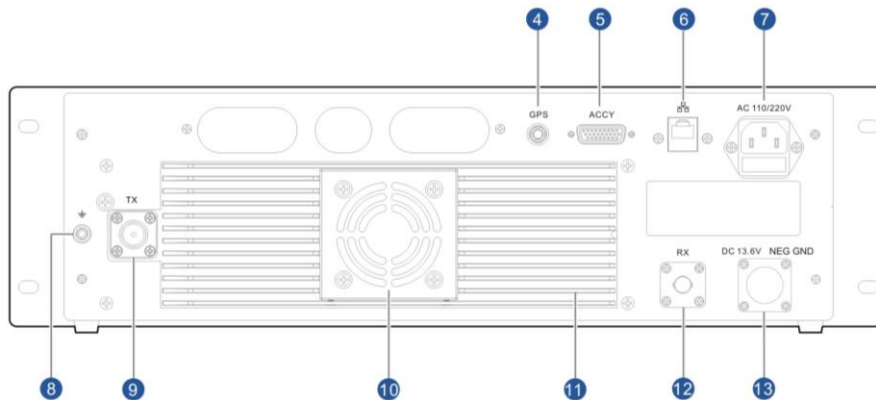

Controls, connectors and components





Refer to the illustration for the location of the following controls, connectors and buttons.

- (1) Handles
- (2) Status indicators
- (3) Power switch
- (4) GPS antenna connector
- (5) Accessory connector
- (6) Ethernet (RJ45) connector
- (7) AC power input connector with fuse holder
- (8) Grounding point
- (9) Transmit antenna connector (N-type)
- (10) Fan
- (11) Heat sink
- (12) Receive antenna connector (BNC)
- (13) DC connector

Status indicators

The LEDs on the front panel indicate various operational states.



LED	Description
TX-A	Indicates slot 1 is transmitting.
RX-A	Indicates slot 1 is receiving.
TX-B	Indicates slot 2 is transmitting.
RX-B	Indicates slot 2 is receiving.
	Repeater mode. Illuminated when the repeater is active. Not lit when the repeater is inactive.
	Analogue mode. For analogue or mixed signals the LED flashes when active. Not lit when the repeater is inactive.
	Digital mode. For digital or mixed the LED flashes when active. Not lit when the repeater is not active.
	Alarm mode. Illuminates when there is a problem with the repeater. See Basic Operation.
	Illuminates when the repeater is powered on.

Unpacking



- (1) DMR Repeater
- (2) Desk mount feet with screws (4 pieces)

Unpack the contents of the box and ensure that all items are received in good condition. If any of the goods are damaged or not supplied, notify your Service Provider within 10 days of receipt of the equipment.

Caution: Product weighs 12.5 Kg, take care when lifting.

Accessory information

Sepura supply a range of accessories for this product. Contact your service provider or visit the Sepura website for a full list of accessories.

Accessory	Part No.
Wall mount bracket	300-01071
AC Power cable (UK)	300-01139
AC Power cable (EU)	300-01141
AC Power cable (US)	300-01138
AC Power cable (AUS)	300-01140
Repeater Battery Backup cable	300-01067

Installation

Guidelines and recommendations

It is important that the repeater does not exceed the working limits detailed in the technical specification section of this guide.

When rack mounting the repeater, ensure sufficient air flow to prevent overheating and secure the unit within the rack system. Cabling should be carefully routed and secured to prevent connections becoming loose.

When desk mounted, always attach the four desk mount feet to the repeater. The desk must have a flat level surface. The repeater creates low level background noise and it is recommended that it is not located in an office environment.

It is recommended that when wall mounted, it must be positioned so that it is clearly visible to personnel to reduce the risk of personal injury by collision. Ensure sufficient air flow to prevent overheating. Cabling should be carefully routed and secured to prevent a trip hazard and connections becoming loose.

The repeater has a battery backup facility that maintains service in the event of an AC power supply failure. It is recommended that both AC and DC power supplies are connected to the repeater to prevent loss of service. If the AC power supply fails, the repeater will shut down and reboot using the DC power supply. Time taken to reboot using the DC supply is typically 60 seconds. When the AC supply is restored, the repeater will switch to the AC supply automatically without a reboot.

Wall-mount bracket installation

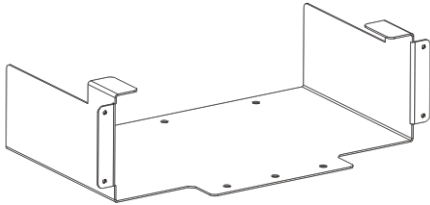

The wall-mount bracket is supplied with the following items:

Item	Qty
ST6 x 35 expansion screw	6
M5 x12 screw	4
Plastic plug	6

Only attach the wall bracket to a solid wall using the fixings supplied.

Use the bracket as a template to position the holes on the wall. Ensure that the bracket is level. Use a small punch or pencil to mark the position of the holes on to the wall.

Drill 6mm diameter holes on the wall in the positions marked and drill to a depth to suit the length of the plastic plugs and screws. Insert the plastic plugs into the holes.

Hold the bracket securely, keeping it level. Secure into position using the ST6 x 35 expansion screws. Ensure that the bracket is secure and level.

Remove the desk mount feet (if fitted) from the repeater. With the top of the repeater against the wall, slide the repeater into the bracket. Secure the repeater to the wall bracket using the four M5 x 12 screws as shown.

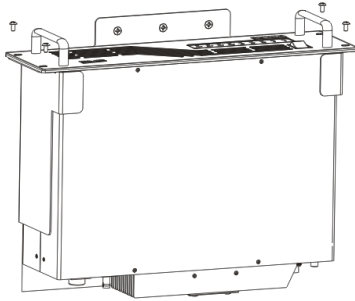

Attaching the desk mount feet

If the repeater is installed onto a desk or bench, the four screw type desk mount feet, supplied with the product, should be attached.

Using a soft cloth or rubber mat to protect the external surfaces, place the repeater with the underside facing upwards, onto a flat surface.

Secure the feet into position using the screws supplied.

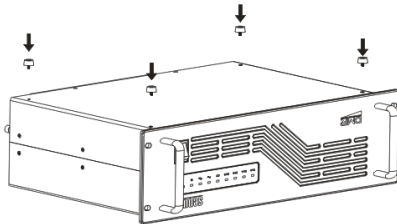

Connections

All connectors are located on the back panel of the repeater.

Ensure that the cables are routed so that they are kept well clear of the antenna cable.

Route cables carefully to eliminate the possibility of damage by sharp edges. Ensure all cabling is secured and routed to avoid the risk of a trip hazard.

AC power supply

Connect AC power supply to the 110/240V AC power input connector.

Connect the repeater grounding point to an appropriate earthing point.

DC power supply

The Repeater Battery Backup cable (optional) is required to connect the repeater to the DC power source.

Connect the repeater grounding point to an appropriate earthing point. Connect the cable to the DC connector on the repeater. Connect the red wire to the positive terminal on the DC power source. Connect the black wire to the negative terminal on the DC power source.

If the power cable needs to be shortened, it must be shortened from the DC power source connection end. A fuse must be fitted to the positive line (red wire) when the cable has been shortened. A new fuse holder must be fitted (not supplied) because the existing fuse holder cannot be reused. The fuse must be positioned close to the DC power source positive terminal.

Caution: Failure to connect the wires to the correct terminal of the battery or power supply may damage the product and void any warranty.

DO NOT extend the Repeater Battery Backup cable. This will affect the backup operation.

Antenna

In order to reduce the risk of RF burns, the antenna must always remain connected whilst the equipment is switched on. Under no circumstances should the antenna be connected or disconnected whilst the equipment is switched on. Do not touch the antenna when the repeater is switched on.

Caution: Do not operate the repeater without an appropriate RF load attached.

Basic operation

Power on/off

To power **on**, operate the Power on/off switch. The Power on/off status indicator illuminates and the repeater runs a start-up test routine that takes approximately 60 seconds. The Alarm indicator illuminates for the duration of the test. On completion of the test routine, the Analogue mode or Digital mode indicator (depending on the selected active channel preference) illuminates.

To power **off**, operate the Power on/off switch.

Voice and data transfer

The repeater uses different frequencies when receiving and transmitting. Received signals that are weak due to attenuation are amplified and transmitted at a higher strength than received.

When transmitting, the repeater mode indicator illuminates. If the repeater is transmitting an analogue signal, the Analogue mode indicator flashes when transmitting. If the transmitting signal is digital the Digital mode indicator flashes when transmitting.

The frequency and DCS/CTCSS for analogue signals, is configured using the DMR Manager software.

Alarm mode

The Alarm indicator on the front panel illuminates when certain operational states warrant. When the repeater is in start-up mode, the LED remains illuminated for the duration of the start-up routine (approx. 60 seconds).

LED state	Alarm condition
Illuminated for more than 60 seconds	The internal temperature exceeds the working limits. or Rx and Tx PLL (Phased Lock Loop) have failed. or Tx VSWR (Voltage Standing Wave Ratio) is incorrect.
Flashing once every second	Rx PLL failure.
Flashing every two seconds	Tx PLL failure.

Configuring the Repeater

The repeater is configured using the DMR Manager software run from a computer connected directly to the repeater or over a network.

Connect a standard LAN/WAN cable (RJ45 connector) to the Network connector on the repeater with the other end connected to either a computer or network connection.

The default IP address for the repeater is 192.168.1.100. This address can be changed using the programming software.

Caring for your product

The product does not require regular servicing. Caring for your product as described in this guide will help maintain the product in good operational condition.

Always wear eye protection when using brushes or other tools to clear debris from connectors or other parts of the product.

Do not use chemicals, aerosols or abrasive cleaners. Chemical coatings must not be applied to any part of the product.

Clean the exterior surfaces using a lint free soft cloth.

Check cable connections regularly to ensure that they are secure.

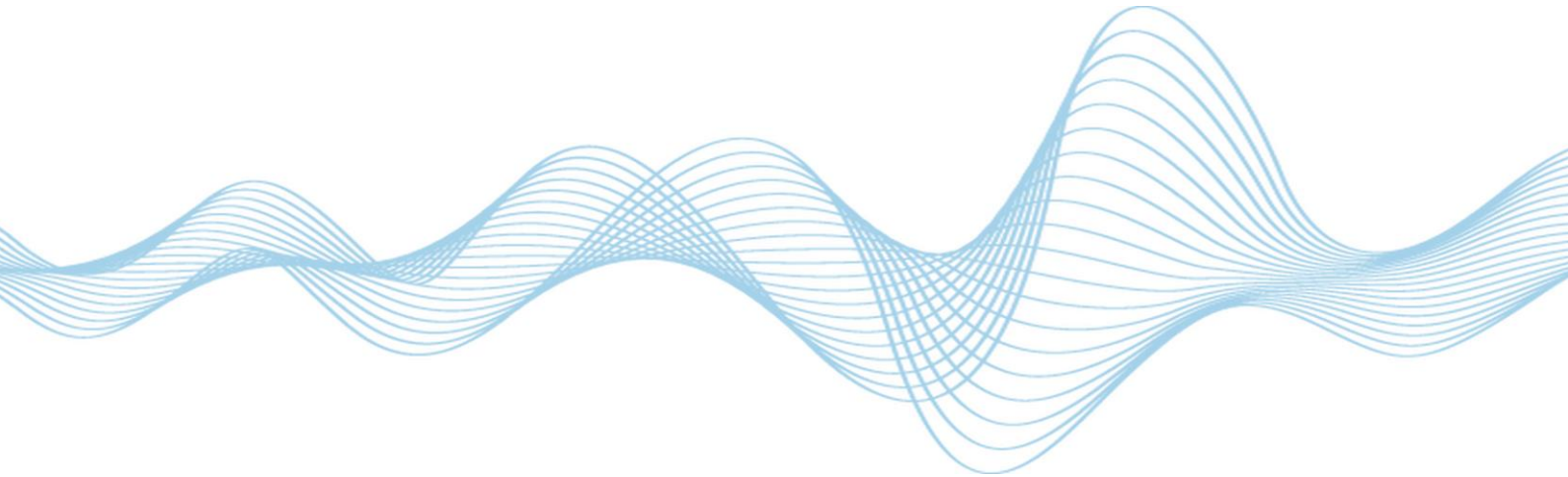

Sepura plc
Radio House
St Andrew's Road
Cambridge
CB4 1GR
Tel: +44 (0)1223 876000
Fax: +44 (0)1223 879000

sepura

sepura.com