

TEST REPORT

Product Name : Petloc8 mini
Brand Name : Myloc8, Petloc8, Petloc8 mini
Model : MYLC002
Series Model : N/A
FCC ID : 2BLZX-MYLC002
Applicant : **Myloc8 Inc**
Address : 680 Central Ave, suite 108, Cedarhurst, New York 11516, USA
Manufacturer : **Myloc8 Inc**
Address : 680 Central Ave, suite 108, Cedarhurst, New York 11516, USA
Standard(s) : FCC CFR Title 47 Part 15 Subpart C Section 15.247
Date of Receipt : Sep. 11, 2024
Date of Test : Sep. 12, 2024 ~ Oct. 24, 2024
Issued Date : Oct. 25, 2024

Issued By: **Guangdong Asia Hongke Test Technology Limited**
B1/F, Building 11, Junfeng Industrial Park, Chongqing Road, Heping Community, Fuhai Street,
Bao'an District, Shenzhen, Guangdong, China
Tel.: +86 0755-230967639 Fax.: +86 0755-230967639

Reviewed by: Leon Yi
Leon.yi

Approved by: Sean She
Sean She



Note: This device has been tested and found to comply with the standard(s) listed, this test report merely corresponds to the test sample. It is not permitted to copy extracts of these test result without the written permission of the test laboratory. This report shall not be reproduced except in full, without the written approval of Guangdong Asia Hongke Test Technology Limited. If there is a need to alter or revise this document, the right belongs to Guangdong Asia Hongke Test Technology Limited, and it should give a prior written notice of the revision document. This test report must not be used by the client to claim product endorsement.



Report Revise Record

Report Version	Issued Date	Notes
M1	Oct. 25, 2024	Initial Release

Contents

1	TEST SUMMARY	4
1.1	TEST STANDARDS	4
1.2	TEST SUMMARY	4
1.3	TEST FACILITY	5
1.4	MEASUREMENT UNCERTAINTY	5
2	GENGENERAL INFORMATION	6
2.1	ENVIRONMENTAL CONDITIONS.....	6
2.2	GENERAL DESCRIPTION OF EUT	6
2.3	DESCRIPTION OF TEST MODES AND TEST FREQUENCY	7
2.4	SPECIAL ACCESSORIES	8
2.5	EQUIPMENT LIST FOR THE TEST.....	8
3	TEST CONDITIONS AND RESULTS	10
3.1	CONDUCTED EMISSIONS TEST.....	10
3.2	RADIATED EMISSIONS AND BAND EDGE	13
3.3	MAXIMUM PEAK CONDUCTED OUTPUT POWER.....	29
3.4	POWER SPECTRAL DENSITY	30
3.5	6DB BANDWIDTH	31
3.6	OUT-OF-BAND EMISSIONS	32
3.7	ANTENNA REQUIREMENT.....	33
4	TEST SETUP PHOTOGRAPHS OF EUT	34
5	EXTERNAL PHOTOGRAPHS OF EUT	35
6	INTERNAL PHOTOGRAPHS OF EUT	38

1 TEST SUMMARY

1.1 Test Standards

The tests were performed according to following standards:

[FCC Rules Part 15.247](#): Frequency Hopping, Direct Spread Spectrum and Hybrid Systems that are in operation within the bands of 902-928 MHz, 2400-2483.5 MHz, and 5725-5850 MHz

[ANSI C63.10: 2013](#): American National Standard for Testing Unlicensed Wireless Devices

[KDB558074 D01 15.247 Meas Guidance v05r02](#): Guidance for Compliance Measurements on Digital Transmission System, Frequency Hopping Spread Spectrum System, and Hybrid System Devices Operating Under Section 15.247 of the FCC Rules

1.2 Test Summary

Test Item	Section in 47 CFR	Result
Antenna requirement	§15.203	Pass
On Time and Duty Cycle	/	/
AC Power Line Conducted Emission	§ 15.207(a)	Pass
Maximum Conducted Peak Output Power	§15.247 (b)(3)	Pass
-6dB Bandwidth	§15.247 (a)(2)	Pass
Power Spectral Density	§15.247 (e)	Pass
Transmitter Radiated Spurious Emission	§15.205/15.209	Pass
Restricted Bands	§15.205/15.209	PASS
Conducted Unwanted emissions and Bandedge	§15.205, §15.247(d)	Pass

1.3 Test Facility

Test Laboratory:

Guangdong Asia Hongke Test Technology Limited

B1/F, Building 11, Junfeng Industrial Park, Chongqing Road, Heping Community, Fuhai Street, Bao'an District, Shenzhen, Guangdong, China

The test facility is recognized, certified or accredited by the following organizations:

FCC-Registration No.: 251906 Designation Number: CN1376

Guangdong Asia Hongke Test Technology Limited has been registered and fully described in a report filed with the (FCC) Federal Communications Commission. The acceptance letter from the FCC is maintained in our files.

IC —Registration No.: 31737 CAB identifier: CN0165

The 3m Semi-anechoic chamber of Guangdong Asia Hongke Test Technology Limited has been registered by Certification and Engineering Bureau of Industry Canada for radio equipment testing with Registration No.: 31737

A2LA-Lab Cert. No.: 7133.01

Guangdong Asia Hongke Test Technology Limited has been accredited by A2LA for technical competence in the field of electrical testing, and proved to be in compliance with ISO/IEC 17025: 2017 General Requirements for the Competence of Testing and Calibration Laboratories and any additional program requirements in the identified field of testing.

1.4 Measurement uncertainty

The data and results referenced in this document are true and accurate. The reader is cautioned that there may be errors within the calibration limits of the equipment and facilities. The measurement uncertainty was calculated for all measurements listed in this test report according to CISPR 16 - 4 “Specification for radio disturbance and immunity measuring apparatus and methods – Part 4: Uncertainty in EMC Measurements” and is documented in the Guangdong Asia Hongke Test Technology Limited’s quality system according to DIN EN ISO/IEC 17025. Furthermore, component and process variability of devices similar to that tested may result in additional deviation. The manufacturer has the sole responsibility of continued compliance of the device.

Hereafter the best measurement capability for Asia Hongke laboratory is reported:

Test	Measurement Uncertainty	Notes
Power Line Conducted Emission	9KHz~30MHz ± 1.20 dB	(1)
Radiated Emission	9KHz~30MHz ± 3.10 dB	(1)
Radiated Emission	30MHz ~1GHz ± 3.75 dB	(1)
Radiated Emission	1GHz~18GHz ± 3.88 dB	(1)
Radiated Emission	18GHz-40GHz ± 3.88 dB	(1)
RF power, conducted	30MHz~6GHz ± 0.16 dB	(1)
RF power density, conducted	± 0.24 dB	(1)
Spurious emissions, conducted	± 0.21 dB	(1)
Temperature	$\pm 1^{\circ}$ C	(1)
Humidity	$\pm 3\%$	(1)
DC and low frequency voltages	$\pm 1.5\%$	(1)
Time	$\pm 2\%$	(1)
Duty cycle	$\pm 2\%$	(1)

The report uncertainty of measurement $y \pm U$, where expanded uncertainty U is based on a standard uncertainty Multiplied by a coverage factor of k=2, providing a level of confidence of approximately 95%.

2 GENGGENERAL INFORMATION

2.1 Environmental conditions

During the measurement the environmental conditions were within the listed ranges:

Normal Temperature:	25°C
Relative Humidity:	55 %
Air Pressure:	101 kPa

2.2 General Description of EUT

Product Name:	Petloc8 mini
Model/Type reference:	MYLC002
Power Supply:	DC 3.80V from battery
Hardware Version:	VPET PCB V1.1
Software Version:	N/A
Sample(s) Status:	AiTSZ-240911008-1(Normal sample) AiTSZ-240911008-2(Engineer sample)
2.4G WIFI:	
Supported type:	802.11b/802.11g /802.11n(HT20)/802.11n(HT40)
Modulation:	802.11b(DSSS):CCK,DQPSK,DBPSK 802.11g(OFDM):BPSK,QPSK,16-QAM,64-QAM 802.11n(OFDM):BPSK,QPSK,16-QAM,64-QAM
Operation frequency:	802.11b/802.11g/802.11n(H20): 2412MHz~2462MHz 802.11n(H40): 2422MHz~2452MHz
Channel number:	802.11b/802.11g/802.11n(H20): 11 802.11n(H40): 7
Channel separation:	5MHz
Antenna type:	LDS Antenna
Antenna gain:	2.32dBi
Remark: The above DUT's information was declared by manufacturer. For more detailed features description, please refer to the manufacturer's specifications or the User's Manual.	

2.3 Description of Test Modes and Test Frequency

There are 11 channels provided to the EUT for 20MHz protocol and 7 channels for 40 MHz protocol. Channel 01/06/11 were selected for 20MHz protocol mode test and channel 03/06/09 were selected for 40MHz protocol mode test.

.Operation Frequency List:

Channel	Frequency(MHz)	Channel	Frequency(MHz)
1	2412	8	2447
2	2417	9	2452
3	2422	10	2457
4	2427	11	2462
5	2432		
6	2437		
7	2442		

Note: The line display in grey were the channel selected for testing

Exploratory testing was performed under each mode combination test channel; only the final measurement of the worst combination was made and recorded in this report.

Test case	Exploratory measurement			Final measurement Recorded In Report		
	Mode	Date rate	Channel	Mode	Date rate	Channel
Maximum output power	802.11b 802.11g 802.11n(HT20) 802.11n(HT40)	1~11Mbps 6~54Mbps MCS0~MCS7 MCS0~MCS7	<input checked="" type="checkbox"/> Lowest <input checked="" type="checkbox"/> Middle <input checked="" type="checkbox"/> Highest	802.11b 802.11g 802.11n(HT20) 802.11n(HT40)	1Mbps 6Mbps MCS0 MCS0	<input checked="" type="checkbox"/> Lowest <input checked="" type="checkbox"/> Middle <input checked="" type="checkbox"/> Highest
Power spectral density	802.11b 802.11g 802.11n(HT20) 802.11n(HT40)	1~11Mbps 6~54Mbps MCS0~MCS7 MCS0~MCS7	<input checked="" type="checkbox"/> Lowest <input checked="" type="checkbox"/> Middle <input checked="" type="checkbox"/> Highest	802.11b 802.11g 802.11n(HT20) 802.11n(HT40)	1Mbps 6Mbps MCS0 MCS0	<input checked="" type="checkbox"/> Lowest <input checked="" type="checkbox"/> Middle <input checked="" type="checkbox"/> Highest
-6dB bandwidth	802.11b 802.11g 802.11n(HT20) 802.11n(HT40)	1~11Mbps 6~54Mbps MCS0~MCS7 MCS0~MCS7	<input checked="" type="checkbox"/> Lowest <input checked="" type="checkbox"/> Middle <input checked="" type="checkbox"/> Highest	802.11b 802.11g 802.11n(HT20) 802.11n(HT40)	1Mbps 6Mbps MCS0 MCS0	<input checked="" type="checkbox"/> Lowest <input checked="" type="checkbox"/> Middle <input checked="" type="checkbox"/> Highest
Conducted Spurious Emissions	802.11b 802.11g 802.11n(HT20) 802.11n(HT40)	1~11Mbps 6~54Mbps MCS0~MCS7 MCS0~MCS7	<input checked="" type="checkbox"/> Lowest <input checked="" type="checkbox"/> Middle <input checked="" type="checkbox"/> Highest	1~11Mbps 6~54Mbps MCS0~MCS7 MCS0~MCS7	1Mbps 6Mbps MCS0 MCS0	<input checked="" type="checkbox"/> Lowest <input checked="" type="checkbox"/> Middle <input checked="" type="checkbox"/> Highest
Conducted Band edge	802.11b 802.11g 802.11n(HT20) 802.11n(HT40)	1~11Mbps 6~54Mbps MCS0~MCS7 MCS0~MCS7	<input checked="" type="checkbox"/> Lowest <input checked="" type="checkbox"/> Highest	1~11Mbps 6~54Mbps MCS0~MCS7 MCS0~MCS7	1Mbps 6Mbps MCS0 MCS0	<input checked="" type="checkbox"/> Lowest <input checked="" type="checkbox"/> Highest
Radiated Band edge	802.11b 802.11g 802.11n(HT20) 802.11n(HT40)	1~11Mbps 6~54Mbps MCS0~MCS7 MCS0~MCS7	<input checked="" type="checkbox"/> Lowest <input checked="" type="checkbox"/> Highest	802.11b 802.11g 802.11n(HT20) 802.11n(HT40)	1Mbps 6Mbps MCS0 MCS0	<input checked="" type="checkbox"/> Lowest <input checked="" type="checkbox"/> Highest
Radiated Emissions Above 1GHz	802.11b 802.11g 802.11n(HT20) 802.11n(HT40)	1~11Mbps 6~54Mbps MCS0~MCS7 MCS0~MCS7	<input checked="" type="checkbox"/> Lowest <input checked="" type="checkbox"/> Middle <input checked="" type="checkbox"/> Highest	802.11b 802.11g 802.11n(HT20) 802.11n(HT40)	1Mbps 6Mbps MCS0 MCS0	<input checked="" type="checkbox"/> Lowest <input checked="" type="checkbox"/> Middle <input checked="" type="checkbox"/> Highest

Radiated Emissions Below 1GHz	802.11b 802.11g 802.11n(HT20) 802.11n(HT40)	1~11Mbps 6~54Mbps MCS0~MCS7 MCS0~MCS7	<input checked="" type="checkbox"/> Lowest <input checked="" type="checkbox"/> Middle <input checked="" type="checkbox"/> Highest	802.11g	6Mbps	<input checked="" type="checkbox"/> Lowest
Conducted Emissions 9KHz-30 MHz	802.11b 802.11g 802.11n(HT20) 802.11n(HT40)	1~11Mbps 6~54Mbps MCS0~MCS7 MCS0~MCS7	<input checked="" type="checkbox"/> Lowest <input checked="" type="checkbox"/> Middle <input checked="" type="checkbox"/> Highest	802.11g	6Mbps	<input checked="" type="checkbox"/> Lowest

Power setting during the test:

During testing, Channel & Power Controlling Software provided by the customer was used to control the operating channel as well as the output power level. The RF output power selection is for the setting of RF output power expected by the customer and is going to be fixed on the firmware of the final end product.

Power Parameters:

Test Software Version	CMD Command		
Frequency	2412/2422MHz	2437MHz	2452/2462MHz
802.11b	Default	Default	Default
802.11g	Default	Default	Default
802.11n(HT20)	Default	Default	Default
802.11n(HT40)	Default	Default	Default

2.4 Special Accessories

Follow auxiliary equipment(s) test with EUT that provided by the manufacturer or laboratory is listed as follow:

Description	Manufacturer	Model	Serial No.	Provided by	Other
Adapter	HNT	HNT-QC530	/	Test lab	/
/	/	/	/	/	/

2.5 Equipment List for the Test

No	Test Equipment	Manufacturer	Model No	Serial No	Pre.Cal. Date	New Cal. Date	Cal. Due Date
1	EMI Measuring Receiver	R&S	ESR	101160	2023.09.26	2024.09.25	2025.09.24
2	Spectrum Analyzer	R&S	FSV40	101470	2023.09.24	2024.09.23	2025.09.22
3	Low Noise Pre Amplifier	SCHWARZBEC K	BBV 9745	00282	2023.09.26	2024.09.25	2025.09.24
4	Low Noise Pre Amplifier	CESHENG	CSKJLNA231016A	CSKJLNA231016A	2023.09.26	2024.09.25	2025.09.24
5	Loop antenna	ETS	6512	00165355	2024.08.29	--	2027.08.28
6	TRILOG Super Broadband test Antenna	SCHWARZBEC K	VULB9168	01434	2024.08.29	--	2027.08.28
7	Broadband Horn Antenna	Schwarzbeck	BBHA 9120D	452	2024.08.29	--	2027.08.28
8	Horn Antenna 15-40GHz	SCHWARZBEC K	BBHA9170	BBHA9170367	2024.08.28	--	2027.08.27
9	6dB Attenuator	JFW	50FPE-006	4360846-949-1	2023.09.25	2024.09.24	2025.09.23
10	EMI Test Receiver	R&S	ESPI	100771	2023.09.26	2024.09.25	2025.09.24
11	LISN	R&S	NNLK 8129	8130179	2023.09.25	2024.09.24	2025.09.23

12	LISN	R&S	ESH3-Z5	892785/016	2023.09.24	2024.09.23	2025.09.22
13	Pulse Limiter	R&S	ESH3-Z2	102789	2023.09.25	2024.09.24	2025.09.23
14	RF Automatic Test system	TST	TSTPASS	21033016	2023.09.26	2024.09.25	2025.09.24
15	Vector Signal Generator	Agilent	N5182A	MY50143009	2023.09.26	2024.09.25	2025.09.24
16	Analog signal generator	Agilent	E8257	MY51554256	2023.09.26	2024.09.25	2025.09.24
17	Spectrum Analyzer	Agilent	N9020A	MY51289843	2023.09.26	2024.09.25	2025.09.24
18	Spectrum Analyzer	Agilent	N9020A	MY53421570	2023.09.26	2024.09.25	2025.09.24
19	Power Sensor	Agilent	8481A	MY41097697	2023.09.26	2024.09.25	2025.09.24
20	Wideband Radio communication tester	R&S	CMW500	1201.0002K50	2023.09.25	2024.09.24	2025.09.23
21	DC power supply	ZHAOXIN	RXN-305D-2	28070002559		N/A	N/A
22	RE Software	EZ	EZ-EMC_RE	Ver.AIT-03A		N/A	N/A
23	CE Software	EZ	EZ-EMC_CE	Ver.AIT-03A		N/A	N/A
24	RF Software	TST	TSTPASS	Version 2.0		N/A	N/A
25	RF Software	cesheng	WCS-WCN	Version 2024.6.20		N/A	N/A
26	temporary antenna connector(Note)	NTS	R001	N/A		N/A	N/A
<p>Note: The temporary antenna connector is soldered on the PCB board in order to perform conducted tests and this temporary antenna connector is listed in the equipment list.</p>							

3 TEST CONDITIONS AND RESULTS

3.1 Conducted Emissions Test

LIMIT

Frequency range (MHz)	Limit (dBuV)	
	Quasi-peak	Average
0.15-0.5	66 to 56*	56 to 46*
0.5-5	56	46
5-30	60	50

* Decreases with the logarithm of the frequency.

TEST CONFIGURATION

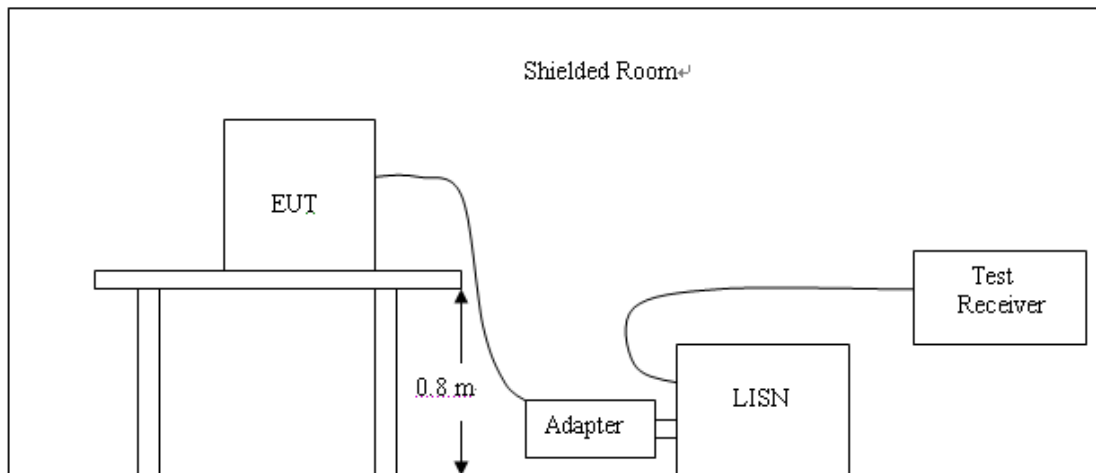

TEST PROCEDURE

1. The equipment was set up as per the test configuration to simulate typical actual usage per the user's manual. The EUT is a tabletop system; a wooden table with a height of 0.8 meters is used and is placed on the ground plane as per ANSI C63.10:2013.
2. Support equipment, if needed, was placed as per ANSI C63.10:2013.
3. All I/O cables were positioned to simulate typical actual usage as per ANSI C63.10:2013.
4. The adapter received AC120V/60Hz power through a Line Impedance Stabilization Network (LISN) which supplied power source and was grounded to the ground plane.
5. All support equipments received AC power from a second LISN, if any.
6. The EUT test program was started. Emissions were measured on each current carrying line of the EUT using a spectrum Analyzer / Receiver connected to the LISN powering the EUT. The LISN has two monitoring points: Line 1 (Hot Side) and Line 2 (Neutral Side). Two scans were taken: one with Line 1 connected to Analyzer / Receiver and Line 2 connected to a 50 ohm load; the second scan had Line 1 connected to a 50 ohm load and Line 2 connected to the Analyzer / Receiver.
7. Analyzer / Receiver scanned from 150 KHz to 30MHz for emissions in each of the test modes.
8. During the above scans, the emissions were maximized by cable manipulation.

TEST RESULTS

Remark:

- Both 120 VAC, 50/60 Hz and 240 VAC, 50/60 Hz power supply have been tested, only the worst result of 120 VAC, 60 Hz was reported as below:
- All three channels (lowest/middle/highest) of each Wi-Fi operation mode were measured and recorded worst case at 802.11g Low Channel.

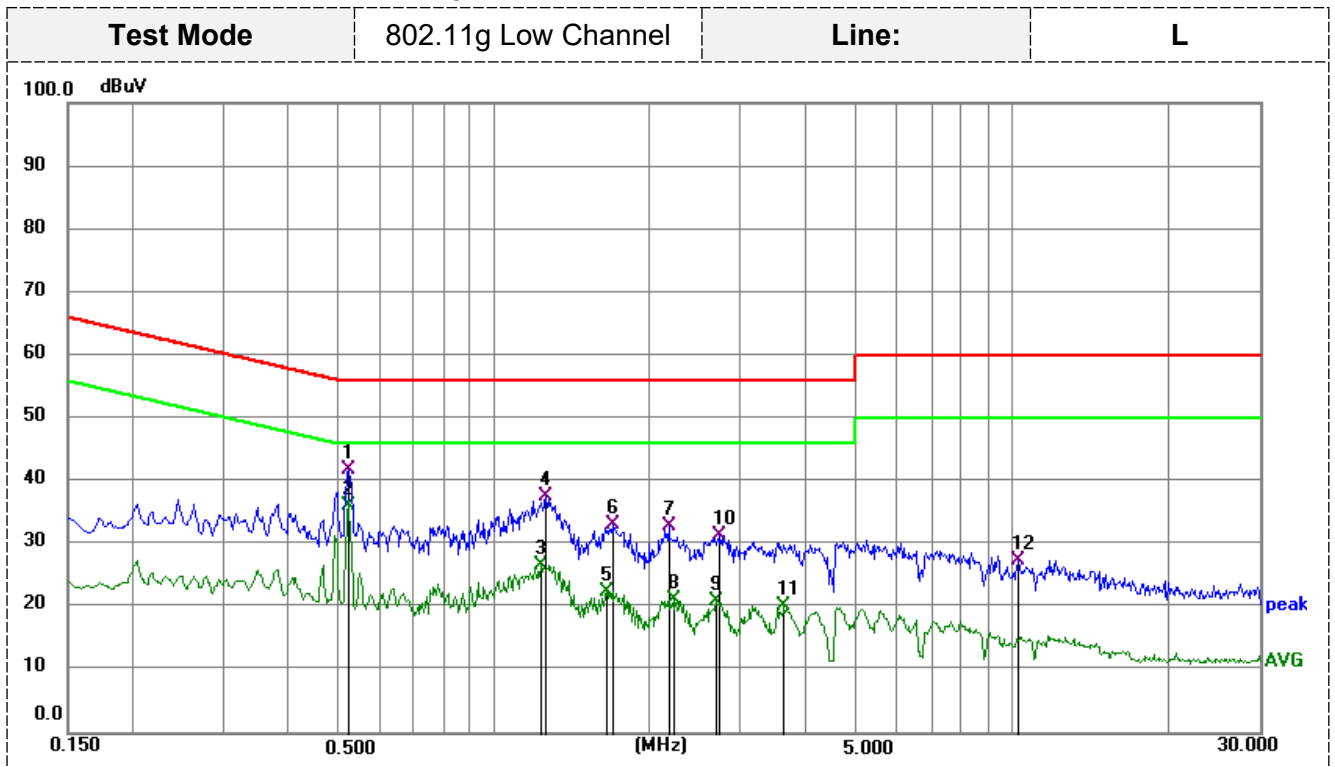

Remark: Correct Factor = Insertion loss of LISN + Cable loss + Insertion loss of Pulse Limiter;
 Measurement Result = Reading Level + Correct Factor;
 Margin = Measurement Result - Limit

No.	Frequency (MHz)	Reading (dBuV)	Correct (dB)	Result (dBuV)	Limit (dBuV)	Margin (dB)	Remark
1	0.5233	31.20	10.69	41.89	56.00	-14.11	QP
2	0.5233	25.32	10.69	36.01	46.00	-9.99	AVG
3	1.2300	16.05	10.68	26.73	46.00	-19.27	AVG
4	1.2570	26.83	10.68	37.51	56.00	-18.49	QP
5	1.6485	11.67	10.74	22.41	46.00	-23.59	AVG
6	1.6980	22.43	10.74	33.17	56.00	-22.83	QP
7	2.1750	22.02	10.79	32.81	56.00	-23.19	QP
8	2.2155	10.40	10.79	21.19	46.00	-24.81	AVG
9	2.6833	10.06	10.80	20.86	46.00	-25.14	AVG
10	2.7330	20.65	10.81	31.46	56.00	-24.54	QP
11	3.6375	9.25	10.98	20.23	46.00	-25.77	AVG
12	10.2523	16.47	11.05	27.52	60.00	-32.48	QP

Test Mode	802.11g Low Channel	Line:	N
------------------	---------------------	--------------	----------

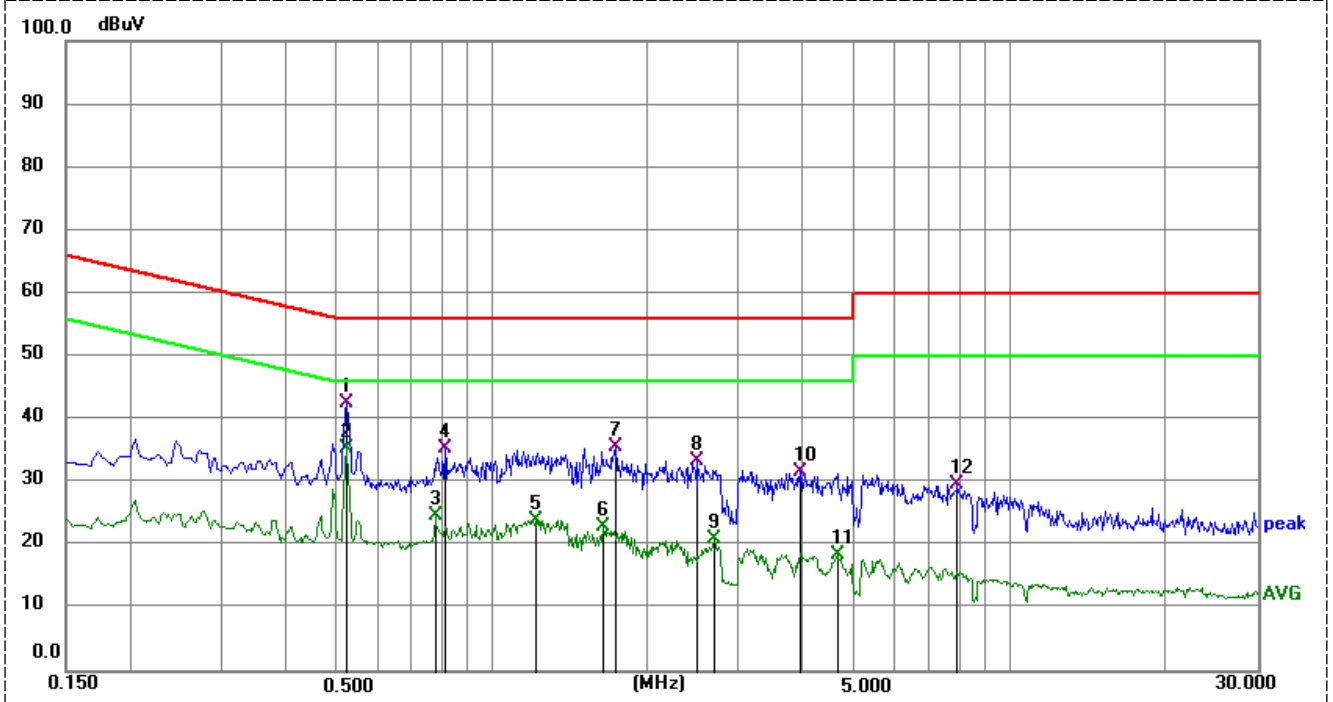

Remark: Correct Factor = Insertion loss of LISN + Cable loss + Insertion loss of Pulse Limiter;
 Measurement Result = Reading Level + Correct Factor;
 Margin = Measurement Result - Limit

No.	Frequency (MHz)	Reading (dBuV)	Correct (dB)	Result (dBuV)	Limit (dBuV)	Margin (dB)	Remark
1	0.5231	31.86	10.69	42.55	56.00	-13.45	QP
2	0.5231	24.76	10.69	35.45	46.00	-10.55	AVG
3	0.7752	14.02	10.66	24.68	46.00	-21.32	AVG
4	0.8114	24.81	10.65	35.46	56.00	-20.54	QP
5	1.2210	13.39	10.67	24.06	46.00	-21.94	AVG
6	1.6440	12.16	10.73	22.89	46.00	-23.11	AVG
7	1.7295	24.75	10.74	35.49	56.00	-20.51	QP
8	2.4900	22.57	10.78	33.35	56.00	-22.65	QP
9	2.6790	10.13	10.79	20.92	46.00	-25.08	AVG
10	3.9344	20.66	10.99	31.65	56.00	-24.35	QP
11	4.6230	7.45	11.01	18.46	46.00	-27.54	AVG
12	7.9214	18.70	11.04	29.74	60.00	-30.26	QP

3.2 Radiated Emissions and Band Edge

Limit

For intentional device, according to § 15.209(a), the general requirement of field strength of radiated emission out of authorized band shall not exceed the following table at a 3 meters measurement distance.

In addition, radiated emissions which fall in the restricted bands, as defined in §15.205(a), must also comply with the radiated emission limits specified in §15.209(a)

Radiated emission limits

Frequency (MHz)	Distance (Meters)	Radiated (dBµV/m)	Radiated (µV/m)
0.009-0.49	3	$20\log(2400/F(\text{KHz}))+40\log(300/3)$	$2400/F(\text{KHz})$
0.49-1.705	3	$20\log(24000/F(\text{KHz}))+40\log(30/3)$	$24000/F(\text{KHz})$
1.705-30	3	$20\log(30)+40\log(30/3)$	30
30-88	3	40.0	100
88-216	3	43.5	150
216-960	3	46.0	200
Above 960	3	54.0	500

TEST CONFIGURATION

(A) Radiated Emission Test Set-Up, Frequency Below 30MHz

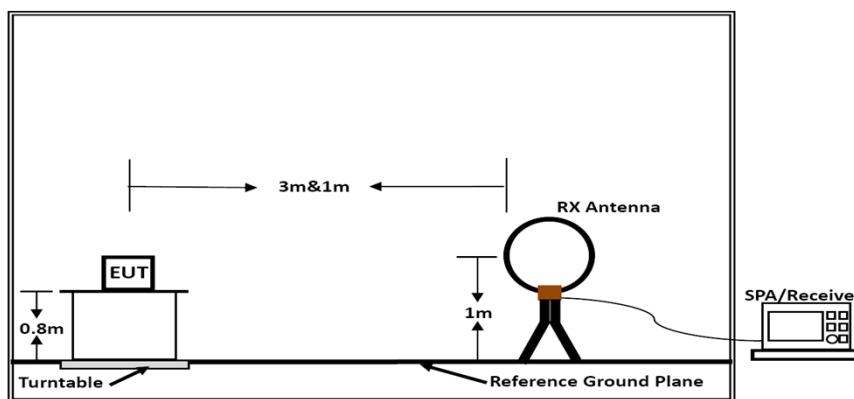

Below 30MHz

(B) Radiated Emission Test Set-Up, Frequency below 1000MHz

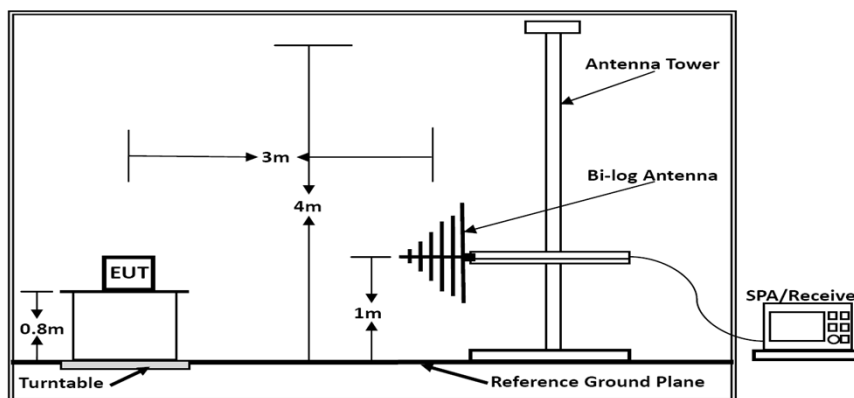

Below 1GHz

(C) Radiated Emission Test Set-Up, Frequency above 1000MHz

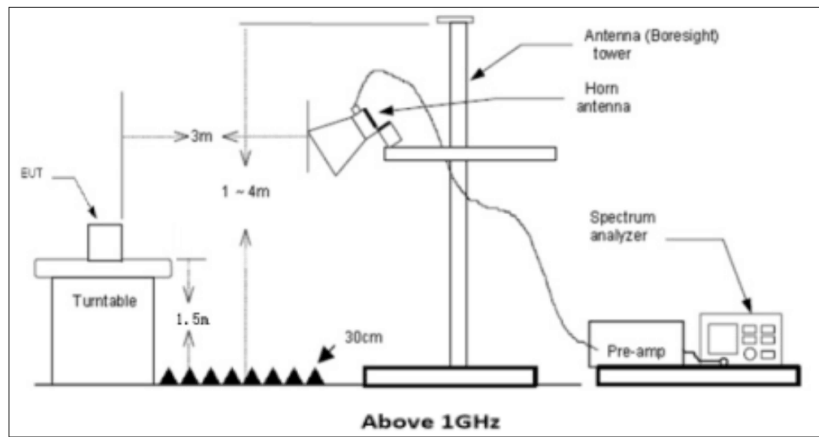

Test Procedure

1. Below 1GHz measurement the EUT is placed on a turntable which is 0.8m above ground plane, and above 1GHz measurement EUT was placed on a low permittivity and low loss tangent turntable which is 1.5m above ground plane.
2. Maximum procedure was performed by raising the receiving antenna from 1m to 4m and rotating the turn table from 0° to 360° to acquire the highest emissions from EUT
3. And also, each emission was to be maximized by changing the polarization of receiving antenna both horizontal and vertical.
4. Repeat above procedures until all frequency measurements have been completed.
5. Radiated emission test frequency band from 9KHz to 25GHz.
6. The distance between test antenna and EUT as following table states:

Test Frequency range	Test Antenna Type	Test Distance
9KHz-30MHz	Active Loop Antenna	3
30MHz-1GHz	Bilog Antenna	3
1GHz-18GHz	Horn Antenna	3
18GHz-25GHz	Horn Antenna	1

7. Setting test receiver/spectrum as following table states:

Test Frequency range	Test Receiver/Spectrum Setting	Detector
9KHz-150KHz	RBW=200Hz/VBW=3KHz, Sweep time=Auto	QP
150KHz-30MHz	RBW=9KHz/VBW=100KHz, Sweep time=Auto	QP
30MHz-1GHz	RBW=120KHz/VBW=1000KHz, Sweep time=Auto	QP
1GHz-40GHz	Peak Value: RBW=1MHz/VBW=3MHz, Sweep time=Auto Average Value: RBW=1MHz/VBW=10Hz, Sweep time=Auto	Peak

TEST RESULTS

Remark:

1. Radiated emission test from 9 KHz to 10th harmonic of fundamental was verified, and The emission levels from 9kHz to 30MHz are attenuated 20dB below the limit and not recorded in report.
2. All three channels (lowest/middle/highest) of each mode were measured below 1GHz and recorded worst case at 802.11g Low Channel.

For 30MHz-1GHz

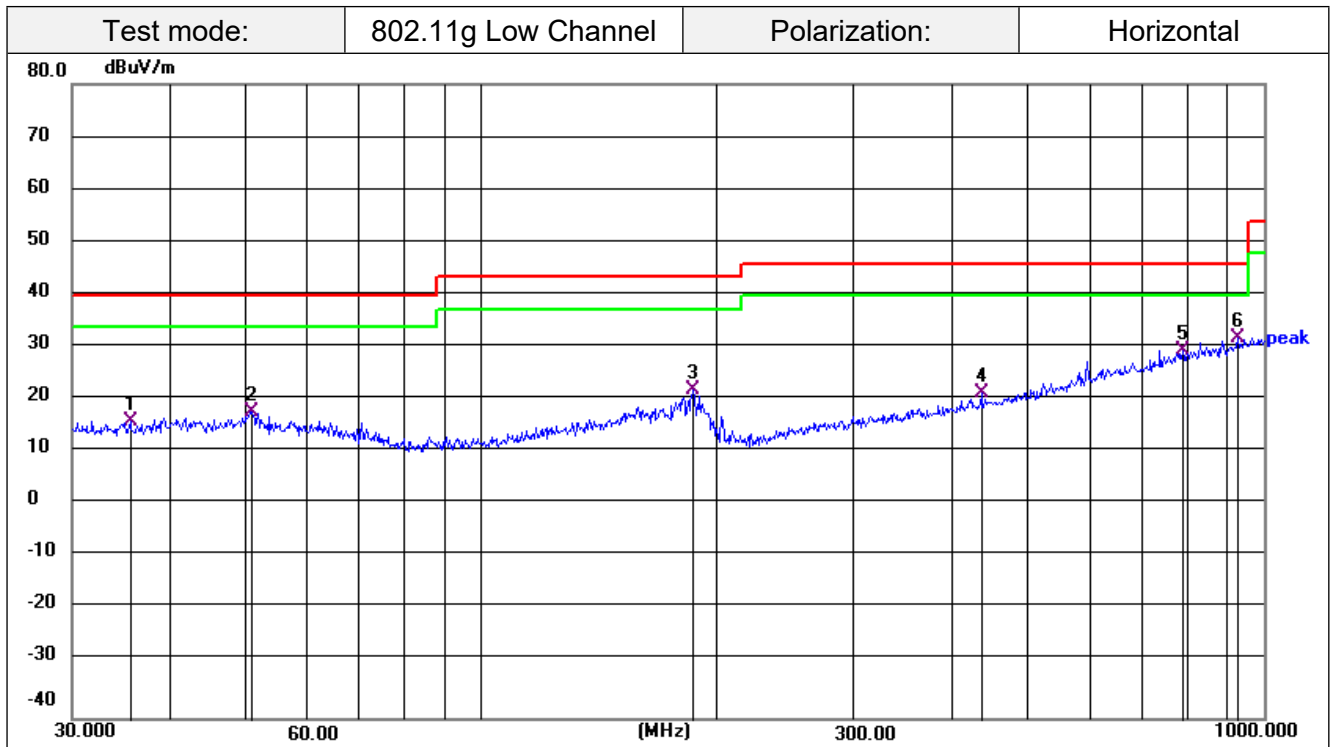

Remark:

Emission Level = Reading + Factor;
 Factor = Antenna Factor + Cable Loss – Pre-amplifier;
 Margin= Emission Level - Limit.

No.	Frequency (MHz)	Reading (dBuV)	Factor (dB/m)	Level (dBuV/m)	Limit (dBuV/m)	Margin (dB)	Det.
1	35.6240	33.53	-17.13	16.40	40.00	-23.60	QP
2	50.9420	34.85	-16.67	18.18	40.00	-21.82	QP
3	186.4409	41.30	-19.04	22.26	43.50	-21.24	QP
4	435.5898	35.32	-13.61	21.71	46.00	-24.29	QP
5	787.8513	35.72	-6.20	29.52	46.00	-16.48	QP
6	925.7563	36.11	-4.15	31.96	46.00	-14.04	QP

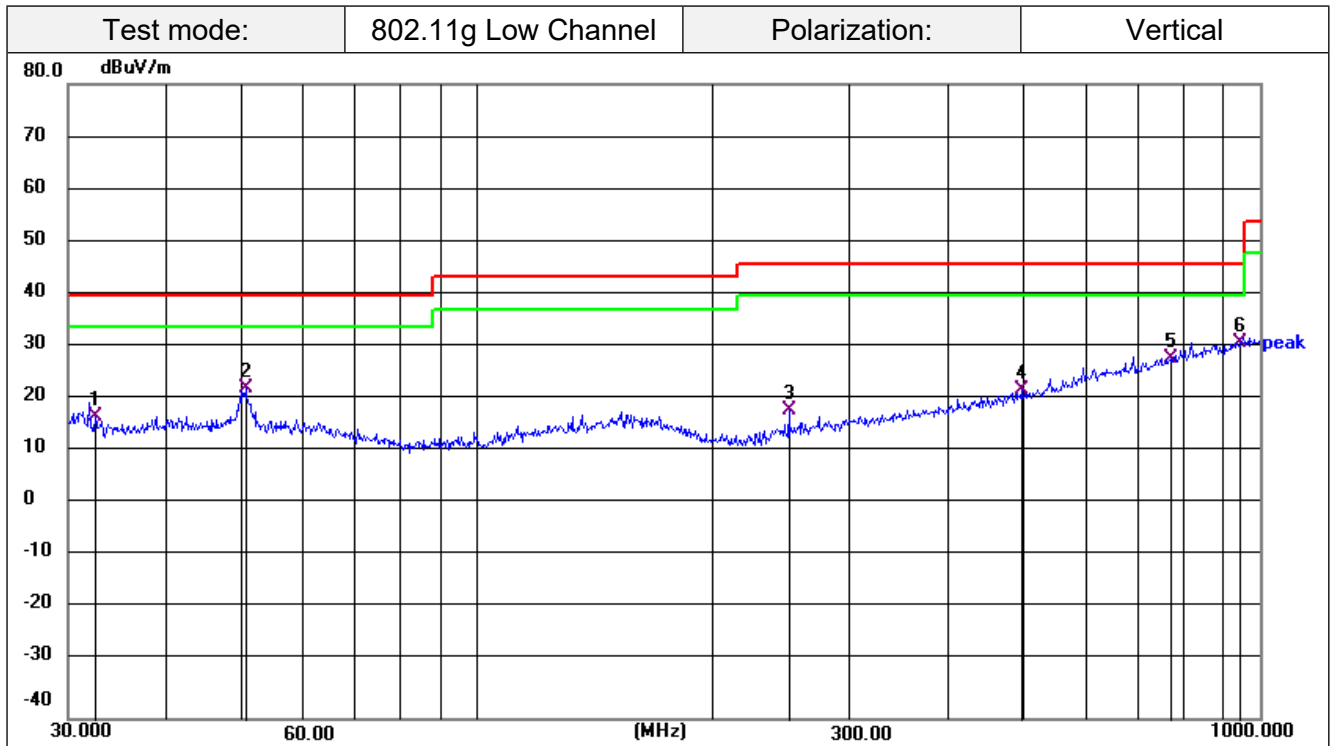

Remark:
 Emission Level = Reading + Factor;
 Factor = Antenna Factor + Cable Loss – Pre-amplifier;
 Margin= Emission Level - Limit.

No.	Frequency (MHz)	Reading (dBuV)	Factor (dB/m)	Level (dBuV/m)	Limit (dBuV/m)	Margin (dB)	Det.
1	32.5197	34.49	-17.39	17.10	40.00	-22.90	QP
2	50.5860	39.02	-16.64	22.38	40.00	-17.62	QP
3	250.3011	37.00	-18.57	18.43	46.00	-27.57	QP
4	495.9344	34.82	-12.58	22.24	46.00	-23.76	QP
5	768.7481	34.66	-6.54	28.12	46.00	-17.88	QP
6	945.4400	34.88	-3.63	31.25	46.00	-14.75	QP

For 1GHz to 25GHz

802.11b (above 1GHz)

Frequency(MHz):		2412		Polarity:	Horizontal	
Frequency	Meter Reading	Factor	Emission Level	Limits	Margin	Detector Type
(MHz)	(dBµV)	(dB/m)	(dBµV/m)	(dBµV/m)	(dB)	
4824.25	63.23	-7.34	55.89	74	-18.11	PEAK
4824.25	53.16	-7.34	45.82	54	-8.18	AVG
7235.70	53.27	-1.34	51.93	74	-22.07	PEAK
--	--	--	--	--	--	AVG

Frequency(MHz):		2412		Polarity:	VERTICAL	
Frequency	Meter Reading	Factor	Emission Level	Limits	Margin	Detector Type
(MHz)	(dBµV)	(dB/m)	(dBµV/m)	(dBµV/m)	(dB)	
4824.25	63.70	-7.34	56.36	74	-17.64	PEAK
4824.25	52.93	-7.34	45.59	54	-8.41	AVG
7235.70	54.28	-1.34	52.94	74	-21.06	PEAK
--	--	--	--	--	--	AVG

Frequency(MHz):		2437		Polarity:	Horizontal	
Frequency	Meter Reading	Factor	Emission Level	Limits	Margin	Detector Type
(MHz)	(dBµV)	(dB/m)	(dBµV/m)	(dBµV/m)	(dB)	
4874.00	58.76	-6.82	51.94	74	-22.06	PEAK
--	--	--	--	--	--	AVG
7311.70	49.41	-0.6	48.81	74	-25.19	PEAK
--	--	--	--	--	--	AVG

Frequency(MHz):		2437		Polarity:	VERTICAL	
Frequency	Meter Reading	Factor	Emission Level	Limits	Margin	Detector Type
(MHz)	(dBµV)	(dB/m)	(dBµV/m)	(dBµV/m)	(dB)	
4874.00	59.14	-6.82	52.32	74	-21.68	PEAK
--	--	--	--	--	--	AVG
7311.70	49.89	-0.6	49.29	74	-24.71	PEAK
--	--	--	--	--	--	AVG

Frequency(MHz):		2462		Polarity:	Horizontal	
Frequency	Meter Reading	Factor	Emission Level	Limits	Margin	Detector Type
(MHz)	(dBµV)	(dB/m)	(dBµV/m)	(dBµV/m)	(dB)	
4923.75	47.02	-6.24	53.56	74	-20.44	PEAK
--	--	--	--	--	--	AVG
7386.30	46.47	0.06	49.37	74	-24.63	PEAK
--	--	--	--	--	--	AVG

Frequency(MHz):		2462		Polarity:	VERTICAL	
Frequency	Meter Reading	Factor	Emission Level	Limits	Margin	Detector Type
(MHz)	(dBµV)	(dB/m)	(dBµV/m)	(dBµV/m)	(dB)	
4923.75	45.63	-6.24	54.28	74	-19.72	PEAK
4923.75	50.94	-6.24	44.70	54	-9.30	AVG
7386.30	45.02	0.06	49.78	74	-24.22	PEAK
--	--	--	--	--	--	AVG

REMARKS:

1. Emission level (dBuV/m) = Reading (dBuV)+ Factor (dB/m)
2. Factor (dB/m) = Antenna Factor (dB/m)+Cable Factor (dB)-Pre-amplifier Factor
3. Margin value = Emission level- Limit value.
4. -- Mean the PK detector measured value is below average limit.
5. Other emission levels are attenuated 20dB below the limit and not recorded in report.
6. RBW1MHz VBW3MHz Peak detector is for PK value; RBW 1MHz VBW10Hz Peak detector is for AV value.

802.11g (above 1GHz)

Frequency(MHz):		2412		Polarity:	Horizontal	
Frequency	Meter Reading	Factor	Emission Level	Limits	Margin	Detector Type
(MHz)	(dBµV)	(dB/m)	(dBµV/m)	(dBµV/m)	(dB)	
4824.75	63.03	-7.34	55.69	74	-18.31	PEAK
4824.75	54.24	-7.34	46.90	54	-7.10	AVG
7235.40	52.30	-1.34	50.96	74	-23.04	PEAK
--	--	--	--	--	--	AVG

Frequency(MHz):		2412		Polarity:	VERTICAL	
Frequency	Meter Reading	Factor	Emission Level	Limits	Margin	Detector Type
(MHz)	(dBµV)	(dB/m)	(dBµV/m)	(dBµV/m)	(dB)	
4824.75	64.17	-7.34	56.83	74	-17.17	PEAK
4824.75	53.00	-7.34	45.66	54	-8.34	AVG
7235.40	53.31	-1.34	51.97	74	-22.03	PEAK
--	--	--	--	--	--	AVG

Frequency(MHz):		2437		Polarity:	Horizontal	
Frequency	Meter Reading	Factor	Emission Level	Limits	Margin	Detector Type
(MHz)	(dBµV)	(dB/m)	(dBµV/m)	(dBµV/m)	(dB)	
4874.00	61.67	-6.82	54.85	74	-19.15	PEAK
4874.00	52.49	-6.82	45.67	54	-8.33	AVG
7311.00	48.11	-0.61	47.50	74	-26.50	PEAK
--	--	--	--	--	--	AVG

Frequency(MHz):		2437		Polarity:	VERTICAL	
Frequency	Meter Reading	Factor	Emission Level	Limits	Margin	Detector Type
(MHz)	(dBµV)	(dB/m)	(dBµV/m)	(dBµV/m)	(dB)	
4874.00	62.22	-6.82	55.40	74	-18.60	PEAK
4874.00	53.51	-6.82	46.69	54	-7.31	AVG
7311.00	48.76	-0.61	48.15	74	-25.85	PEAK
--	--	--	--	--	--	AVG

Frequency(MHz):		2462		Polarity:	Horizontal	
Frequency	Meter Reading	Factor	Emission Level	Limits	Margin	Detector Type
(MHz)	(dBµV)	(dB/m)	(dBµV/m)	(dBµV/m)	(dB)	
4924.70	47.02	-6.23	53.98	74	-20.02	PEAK
--	--	--	--	--	--	AVG
7385.90	46.47	0.05	47.46	74	-26.54	PEAK
--	--	--	--	--	--	AVG

Frequency(MHz):		2462		Polarity:	VERTICAL	
Frequency	Meter Reading	Factor	Emission Level	Limits	Margin	Detector Type
(MHz)	(dBµV)	(dB/m)	(dBµV/m)	(dBµV/m)	(dB)	
4924.70	45.63	-6.23	54.65	74	-19.35	PEAK
4924.70	50.99	-6.23	44.76	54	-9.24	AVG
7385.90	45.02	0.05	47.53	74	-26.47	PEAK
--	--	--	--	--	--	AVG

REMARKS:

1. Emission level (dBuV/m) = Reading (dBuV)+ Factor (dB/m)
2. Factor (dB/m) = Antenna Factor (dB/m)+Cable Factor (dB)-Pre-amplifier Factor
3. Margin value = Emission level- Limit value.
4. -- Mean the PK detector measured value is below average limit.
5. Other emission levels are attenuated 20dB below the limit and not recorded in report.
6. RBW1MHz VBW3MHz Peak detector is for PK value; RBW 1MHz VBW10Hz Peak detector is for AV value.

802.11n(HT20) (above 1GHz)

Frequency(MHz):		2412		Polarity:	Horizontal	
Frequency	Meter Reading	Factor	Emission Level	Limits	Margin	Detector Type
(MHz)	(dBµV)	(dB/m)	(dBµV/m)	(dBµV/m)	(dB)	
4824.55	58.51	-7.34	51.17	74	-22.83	PEAK
--	--	--	--	--	--	AVG
7236.35	51.14	-1.34	49.80	74	-24.20	PEAK
--	--	--	--	--	--	AVG

Frequency(MHz):		2412		Polarity:	VERTICAL	
Frequency	Meter Reading	Factor	Emission Level	Limits	Margin	Detector Type
(MHz)	(dBµV)	(dB/m)	(dBµV/m)	(dBµV/m)	(dB)	
4824.55	58.84	-7.34	51.50	74	-22.50	PEAK
--	--	--	--	--	--	AVG
7236.35	52.09	-1.34	50.75	74	-23.25	PEAK
--	--	--	--	--	--	AVG

Frequency(MHz):		2437		Polarity:	Horizontal	
Frequency	Meter Reading	Factor	Emission Level	Limits	Margin	Detector Type
(MHz)	(dBµV)	(dB/m)	(dBµV/m)	(dBµV/m)	(dB)	
4873.40	61.46	-6.82	54.64	74	-19.36	PEAK
4873.40	51.93	-6.82	45.11	54	-8.89	AVG
7311.55	50.94	-0.6	50.34	74	-23.66	PEAK
--	--	--	--	--	--	AVG

Frequency(MHz):		2437		Polarity:	VERTICAL	
Frequency	Meter Reading	Factor	Emission Level	Limits	Margin	Detector Type
(MHz)	(dBµV)	(dB/m)	(dBµV/m)	(dBµV/m)	(dB)	
4873.40	62.32	-6.82	55.50	74	-18.50	PEAK
4873.40	52.68	-6.82	45.86	54	-8.14	AVG
7311.55	51.63	-0.6	51.03	74	-22.97	PEAK
--	--	--	--	--	--	AVG

Frequency(MHz):		2462		Polarity:	Horizontal	
Frequency	Meter Reading	Factor	Emission Level	Limits	Margin	Detector Type
(MHz)	(dBµV)	(dB/m)	(dBµV/m)	(dBµV/m)	(dB)	
4924.75	47.02	-6.23	55.98	74	-18.02	PEAK
4924.75	50.98	-6.23	44.75	54	-9.25	AVG
7386.40	46.47	0.06	51.12	74	-22.88	PEAK
--	--	--	--	--	--	AVG

Frequency(MHz):		2462		Polarity:	VERTICAL	
Frequency	Meter Reading	Factor	Emission Level	Limits	Margin	Detector Type
(MHz)	(dBµV)	(dB/m)	(dBµV/m)	(dBµV/m)	(dB)	
4924.75	45.63	-6.23	56.81	74	-17.19	PEAK
4924.75	51.49	-6.23	45.26	54	-8.74	AVG
7386.40	45.02	0.06	51.14	74	-22.86	PEAK
--	--	--	--	--	--	AVG

REMARKS:

1. Emission level (dBuV/m) = Reading (dBuV)+ Factor (dB/m)
2. Factor (dB/m) = Antenna Factor (dB/m)+Cable Factor (dB)-Pre-amplifier Factor
3. Margin value = Emission level- Limit value.
4. -- Mean the PK detector measured value is below average limit.
5. Other emission levels are attenuated 20dB below the limit and not recorded in report.
6. RBW1MHz VBW3MHz Peak detector is for PK value; RBW 1MHz VBW10Hz Peak detector is for AV value.

802.11n(HT40) (above 1GHz)

Frequency(MHz):		2422		Polarity:	Horizontal	
Frequency	Meter Reading	Factor	Emission Level	Limits	Margin	Detector Type
(MHz)	(dBµV)	(dB/m)	(dBµV/m)	(dBµV/m)	(dB)	
4843.40	63.05	-7.14	55.91	74	-18.09	PEAK
4843.40	53.25	-7.14	46.11	54	-7.89	AVG
7266.40	49.02	-1.04	47.98	74	-26.02	PEAK
--	--	--	--	--	--	AVG

Frequency(MHz):		2422		Polarity:	VERTICAL	
Frequency	Meter Reading	Factor	Emission Level	Limits	Margin	Detector Type
(MHz)	(dBµV)	(dB/m)	(dBµV/m)	(dBµV/m)	(dB)	
4843.40	63.35	-7.14	56.21	74	-17.79	PEAK
4843.40	53.55	-7.14	46.41	54	-7.59	AVG
7266.40	49.51	-1.04	48.47	74	-25.53	PEAK
--	--	--	--	--	--	AVG

Frequency(MHz):		2437		Polarity:	Horizontal	
Frequency	Meter Reading	Factor	Emission Level	Limits	Margin	Detector Type
(MHz)	(dBµV)	(dB/m)	(dBµV/m)	(dBµV/m)	(dB)	
4874.50	62.28	-6.81	55.47	74	-18.53	PEAK
4874.50	52.95	-6.81	46.14	54	-7.86	AVG
7311.20	48.57	-0.61	47.96	74	-26.04	PEAK
--	--	--	--	--	--	AVG

Frequency(MHz):		2437		Polarity:	VERTICAL	
Frequency	Meter Reading	Factor	Emission Level	Limits	Margin	Detector Type
(MHz)	(dBµV)	(dB/m)	(dBµV/m)	(dBµV/m)	(dB)	
4874.50	62.58	-6.81	55.77	74	-18.23	PEAK
4874.50	53.72	-6.81	46.91	54	-7.09	AVG
7311.20	49.47	-0.61	48.86	74	-25.14	PEAK
--	--	--	--	--	--	AVG

Frequency(MHz):		2452		Polarity:	Horizontal	
Frequency	Meter Reading	Factor	Emission Level	Limits	Margin	Detector Type
(MHz)	(dBμV)	(dB/m)	(dBμV/m)	(dBμV/m)	(dB)	
4903.70	47.02	-6.5	55.71	74	-18.29	PEAK
4903.70	52.60	-6.50	46.10	54	-7.90	AVG
7356.00	46.47	-0.22	51.86	74	-22.14	PEAK
--	--	--	--	--	--	AVG

Frequency(MHz):		2452		Polarity:	VERTICAL	
Frequency	Meter Reading	Factor	Emission Level	Limits	Margin	Detector Type
(MHz)	(dBμV)	(dB/m)	(dBμV/m)	(dBμV/m)	(dB)	
4903.70	45.63	-6.5	55.89	74	-18.11	PEAK
4903.70	51.56	-6.50	45.06	54	-8.94	AVG
7356.00	45.02	-0.22	52.77	74	-21.23	PEAK
--	--	--	--	--	--	AVG

REMARKS:

1. Emission level (dBuV/m) = Reading (dBuV)+ Factor (dB/m)
2. Factor (dB/m) = Antenna Factor (dB/m)+Cable Factor (dB)-Pre-amplifier Factor
3. Margin value = Emission level- Limit value.
4. -- Mean the PK detector measured value is below average limit.
5. Other emission levels are attenuated 20dB below the limit and not recorded in report.
6. RBW1MHz VBW3MHz Peak detector is for PK value; RBW 1MHz VBW10Hz Peak detector is for AV value.

Radiation Restricted band

802.11b

Frequency(MHz):		2412		Polarity:	Horizontal	
Frequency	Meter Reading	Factor	Emission Level	Limits	Margin	Detector Type
(MHz)	(dBμV)	(dB/m)	(dBμV/m)	(dBμV/m)	(dB)	
2387.11	60.42	-4.06	56.36	74	-17.64	PEAK
2387.11	49.78	-4.06	45.72	54	-8.28	AVG
2390.00	40.62	-4.10	50.37	74	-23.63	PEAK
--	--	--	--	--	--	AVG

Frequency(MHz):		2412		Polarity:	Vertical	
Frequency	Meter Reading	Factor	Emission Level	Limits	Margin	Detector Type
(MHz)	(dBμV)	(dB/m)	(dBμV/m)	(dBμV/m)	(dB)	
2386.06	60.68	-4.04	56.64	74	-17.36	PEAK
2386.06	52.28	-4.04	48.24	54	-5.76	AVG
2390.00	55.59	-4.10	51.49	74	-22.51	PEAK
--	--	--	--	--	--	AVG

Frequency(MHz):		2462		Polarity:	Horizontal	
Frequency	Meter Reading	Factor	Emission Level	Limits	Margin	Detector Type
(MHz)	(dBμV)	(dB/m)	(dBμV/m)	(dBμV/m)	(dB)	
2483.50	59.04	-3.09	55.95	74	-18.05	PEAK
2483.50	49.60	-3.09	46.51	54	-7.49	AVG
2484.44	48.59	-3.08	45.51	74	-28.49	PEAK
--	--	--	--	--	--	AVG

Frequency(MHz):		2462		Polarity:	Vertical	
Frequency	Meter Reading	Factor	Emission Level	Limits	Margin	Detector Type
(MHz)	(dBμV)	(dB/m)	(dBμV/m)	(dBμV/m)	(dB)	
2483.50	59.47	-3.09	56.38	74	-17.62	PEAK
2483.50	52.45	-3.09	49.36	54	-4.64	AVG
2486.82	49.17	-3.05	46.12	74	-27.88	PEAK
--	--	--	--	--	--	AVG

REMARKS:

1. Emission level (dBuV/m) = Reading (dBuV)+ Factor (dB/m)
2. Factor (dB/m) = Antenna Factor (dB/m)+Cable Factor (dB)-Pre-amplifier Factor
3. Margin value = Emission level- Limit value.
4. Other emission levels are attenuated 20dB below the limit and not recorded in report.
5. RBW1MHz VBW3MHz Peak detector is for PK value; RBW 1MHz VBW10Hz Peak detector is for AV value.

802.11g

Frequency(MHz):		2412		Polarity:	Horizontal	
Frequency	Meter Reading	Factor	Emission Level	Limits	Margin	Detector Type
(MHz)	(dBµV)	(dB/m)	(dBµV/m)	(dBµV/m)	(dB)	
2385.28	60.28	-4.03	56.25	74	-17.75	PEAK
2385.28	50.10	-4.03	46.07	54	-7.93	AVG
2390.00	40.62	-4.10	53.65	74	-20.35	PEAK
--	--	--	--	--	--	AVG

Frequency(MHz):		2412		Polarity:	Vertical	
Frequency	Meter Reading	Factor	Emission Level	Limits	Margin	Detector Type
(MHz)	(dBµV)	(dB/m)	(dBµV/m)	(dBµV/m)	(dB)	
2386.28	60.50	-4.04	56.46	74	-17.54	PEAK
2386.28	52.43	-4.04	48.39	54	-5.61	AVG
2390.00	58.47	-4.10	54.37	74	-19.63	PEAK
2390.00	53.42	-4.10	49.32	54	-4.68	AVG

Frequency(MHz):		2462		Polarity:	Horizontal	
Frequency	Meter Reading	Factor	Emission Level	Limits	Margin	Detector Type
(MHz)	(dBµV)	(dB/m)	(dBµV/m)	(dBµV/m)	(dB)	
2483.50	59.87	-3.09	56.78	74	-17.22	PEAK
2483.50	50.87	-3.09	47.78	54	-6.22	AVG
2487.48	52.76	-3.04	49.72	74	-24.28	PEAK
--	--	--	--	--	--	AVG

Frequency(MHz):		2462		Polarity:	Vertical	
Frequency	Meter Reading	Factor	Emission Level	Limits	Margin	Detector Type
(MHz)	(dBµV)	(dB/m)	(dBµV/m)	(dBµV/m)	(dB)	
2483.50	60.35	-3.09	57.26	74	-16.74	PEAK
2483.50	53.27	-3.09	50.18	54	-3.82	AVG
2486.36	52.91	-3.05	49.86	74	-24.14	PEAK
--	--	--	--	--	--	AVG

REMARKS:

1. Emission level (dBuV/m) = Reading (dBuV)+ Factor (dB/m)
2. Factor (dB/m) = Antenna Factor (dB/m)+Cable Factor (dB)-Pre-amplifier Factor
3. Margin value = Emission level- Limit value.
4. Other emission levels are attenuated 20dB below the limit and not recorded in report.
5. RBW1MHz VBW3MHz Peak detector is for PK value; RBW 1MHz VBW10Hz Peak detector is for AV value.

802.11n(HT20)

Frequency(MHz):		2412		Polarity:	Horizontal	
Frequency	Meter Reading	Factor	Emission Level	Limits	Margin	Detector Type
(MHz)	(dBµV)	(dB/m)	(dBµV/m)	(dBµV/m)	(dB)	
2388.18	60.86	-4.07	56.79	74	-17.21	PEAK
2388.18	50.16	-4.07	46.09	54	-7.91	AVG
2390.00	40.62	-4.10	53.23	74	-20.77	PEAK
--	--	--	--	--	--	AVG

Frequency(MHz):		2412		Polarity:	Vertical	
Frequency	Meter Reading	Factor	Emission Level	Limits	Margin	Detector Type
(MHz)	(dBµV)	(dB/m)	(dBµV/m)	(dBµV/m)	(dB)	
2389.98	62.09	-4.10	57.99	74	-16.01	PEAK
2389.98	54.08	-4.10	49.98	54	-4.02	AVG
2390.00	57.99	-4.10	53.89	74	-20.11	PEAK
--	--	--	--	--	--	AVG

Frequency(MHz):		2462		Polarity:	Horizontal	
Frequency	Meter Reading	Factor	Emission Level	Limits	Margin	Detector Type
(MHz)	(dBµV)	(dB/m)	(dBµV/m)	(dBµV/m)	(dB)	
2483.50	57.83	-3.09	54.74	74	-19.26	PEAK
2483.50	49.70	-3.09	46.61	54	-7.39	AVG
2485.80	49.52	-3.06	46.46	74	-27.54	PEAK
--	--	--	--	--	--	AVG

Frequency(MHz):		2462		Polarity:	Vertical	
Frequency	Meter Reading	Factor	Emission Level	Limits	Margin	Detector Type
(MHz)	(dBµV)	(dB/m)	(dBµV/m)	(dBµV/m)	(dB)	
2483.50	58.45	-3.09	55.36	74	-18.64	PEAK
2483.50	50.47	-3.09	47.38	54	-6.62	AVG
2484.01	49.81	-3.09	46.72	74	-27.28	PEAK
--	--	--	--	--	--	AVG

REMARKS:

1. Emission level (dBuV/m) = Reading (dBuV)+ Factor (dB/m)
2. Factor (dB/m) = Antenna Factor (dB/m)+Cable Factor (dB)-Pre-amplifier Factor
3. Margin value = Emission level- Limit value.
4. Other emission levels are attenuated 20dB below the limit and not recorded in report.
5. RBW1MHz VBW3MHz Peak detector is for PK value; RBW 1MHz VBW10Hz Peak detector is for AV value.

802.11n(HT40)

Frequency(MHz):		2422		Polarity:	Horizontal	
Frequency	Meter Reading	Factor	Emission Level	Limits	Margin	Detector Type
(MHz)	(dBμV)	(dB/m)	(dBμV/m)	(dBμV/m)	(dB)	
2389.15	61.58	-4.09	57.49	74	-16.51	PEAK
2389.15	53.46	-4.09	49.37	54	-4.63	AVG
2390.00	40.62	-4.10	56.70	74	-17.30	PEAK
2390.00	50.73	-4.10	46.63	54	-7.37	AVG

Frequency(MHz):		2422		Polarity:	Vertical	
Frequency	Meter Reading	Factor	Emission Level	Limits	Margin	Detector Type
(MHz)	(dBμV)	(dB/m)	(dBμV/m)	(dBμV/m)	(dB)	
2387.61	62.44	-4.06	58.38	74	-15.62	PEAK
2387.61	54.12	-4.06	50.06	54	-3.94	AVG
2390.00	61.52	-4.10	57.42	74	-16.58	PEAK
2390.00	55.77	-4.10	51.67	54	-2.33	AVG

Frequency(MHz):		2452		Polarity:	Horizontal	
Frequency	Meter Reading	Factor	Emission Level	Limits	Margin	Detector Type
(MHz)	(dBμV)	(dB/m)	(dBμV/m)	(dBμV/m)	(dB)	
2483.50	58.31	-3.09	55.22	74	-18.78	PEAK
2483.50	49.70	-3.09	46.61	54	-7.39	AVG
2485.87	48.29	-3.06	45.23	74	-28.77	PEAK
--	--	--	--	--	--	AVG

Frequency(MHz):		2452		Polarity:	Vertical	
Frequency	Meter Reading	Factor	Emission Level	Limits	Margin	Detector Type
(MHz)	(dBμV)	(dB/m)	(dBμV/m)	(dBμV/m)	(dB)	
2483.50	58.68	-3.09	55.59	74	-18.41	PEAK
2483.50	50.03	-3.09	46.94	54	-7.06	AVG
2488.30	48.40	-3.03	45.37	74	-28.63	PEAK
--	--	--	--	--	--	AVG

REMARKS:

6. Emission level (dBuV/m) = Reading (dBuV)+ Factor (dB/m)
7. Factor (dB/m) = Antenna Factor (dB/m)+Cable Factor (dB)-Pre-amplifier Factor
8. Margin value = Emission level- Limit value.
9. Other emission levels are attenuated 20dB below the limit and not recorded in report.
10. RBW1MHz VBW3MHz Peak detector is for PK value; RBW 1MHz VBW10Hz Peak detector is for AV value.

3.3 Maximum Peak Conducted Output Power

Limit

The Maximum Peak Output Power Measurement is 30dBm.

Test Procedure

Remove the antenna from the EUT and then connect a low loss RF cable from the antenna port to the Power Meter.

Test Configuration

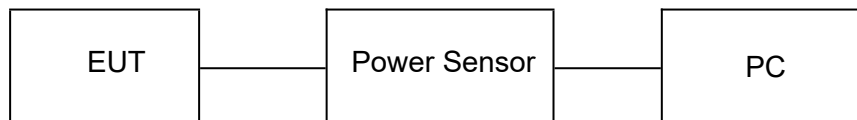

Test Results

Pass **Not Applicable**

Note:

For test data, please refer to Appendix RF test data for WIFI2.4G.

3.4 Power Spectral Density

Limit

For digitally modulated systems, the power spectral density conducted from the intentional radiator to the antenna shall not be greater than 8 dBm in any 3 kHz band during any time interval of continuous transmission.

Test Procedure

1. Use this procedure when the maximum peak conducted output power in the fundamental emission is used to demonstrate compliance.
2. Set the RBW \geq 3 kHz.
3. Set the VBW \geq 3 \times RBW.
4. Set the span to 1.5 times the DTS channel bandwidth.
5. Detector = peak.
6. Sweep time = auto couple.
7. Trace mode = max hold.
8. Allow trace to fully stabilize.
9. Use the peak marker function to determine the maximum power level.
10. If measured value exceeds limit, reduce RBW (no less than 3 kHz) and repeat.
11. The resulting peak PSD level must be 8dBm.

Test Configuration

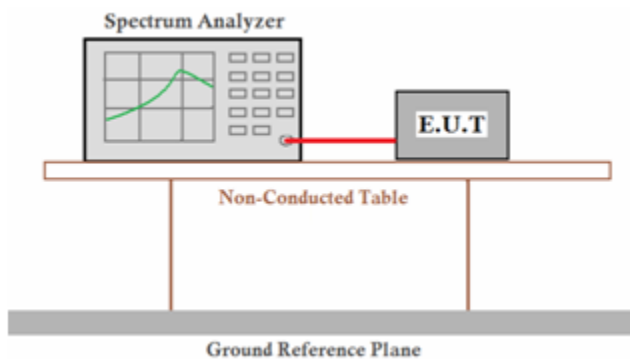

Test Results

Pass **Not Applicable**

Note:

For test data, please refer to Appendix RF test data for WIFI2.4G.

3.5 6dB Bandwidth

Limit

For digital modulation systems, the minimum 6 dB bandwidth shall be at least 500 kHz

Test Procedure

The transmitter output was connected to the spectrum analyzer through an attenuator. The bandwidth of the fundamental frequency was measured by spectrum analyzer with 100 KHz RBW and 300 KHz VBW. The 6dB bandwidth is defined as the total spectrum the power of which is higher than peak power minus 6dB. Measured the 6dB bandwidth by related function of the spectrum analyzer.

Test Configuration

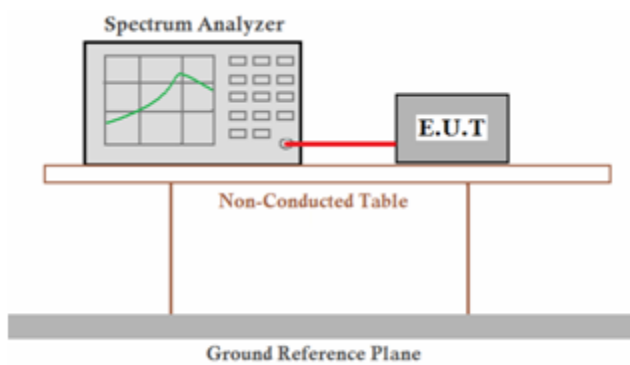

Test Results

Pass Not Applicable

Note:

For test data, please refer to Appendix RF test data for WIFI2.4G.

3.6 Out-of-band Emissions

Limit

In any 100 kHz bandwidth outside the frequency band in which the spread spectrum or digitally modulated intentional radiator is operating, the radio frequency power that is produced by the intentional radiator shall be at least 20 dB below that in the 100 kHz bandwidth within the band that contains the highest level of the desired power, based on either an RF conducted or a radiated measurement, provided the transmitter demonstrates compliance with the peak conducted power limits. If the transmitter complies with the conducted power limits based on the use of RMS averaging over a time interval, as permitted under paragraph (b)(3) of this section, the attenuation required under this paragraph shall be 30 dB instead of 20 dB. Attenuation below the general limits specified in §15.209(a) is not required.

Test Procedure

Connect the transmitter output to spectrum analyzer using a low loss RF cable, and set the spectrum analyzer to RBW=100 kHz, VBW= 300 kHz, peak detector, and max hold. Measurements utilizing these setting are made of the in-band reference level, bandedge and out-of-band emissions.

Test Configuration

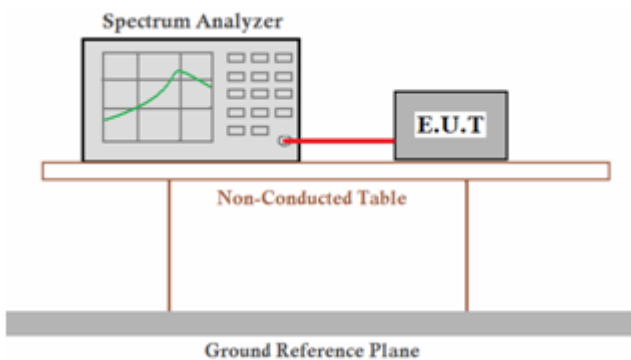

Test Results

Pass Not Applicable

Note:

For test data, please refer to Appendix RF test data for WIFI2.4G.

3.7 Antenna Requirement

Standard Applicable

For intentional device, according to FCC 47 CFR Section 15.203:

An intentional radiator shall be designed to ensure that no antenna other than that furnished by the responsible party shall be used with the device. The use of a permanently attached antenna or of an antenna that uses a unique coupling to the intentional radiator, the manufacturer may design the unit so that a broken antenna can be replaced by the user, but the use of a standard antenna jack or electrical connector is prohibited

FCC CFR Title 47 Part 15 Subpart C Section 15.247(b) (4):

(4) The conducted output power limit specified in paragraph (b) of this section is based on the use of antennas with directional gains that do not exceed 6 dBi. Except as shown in paragraph (c) of this section, if transmitting antennas of directional gain greater than 6 dBi are used, the conducted output power from the intentional radiator shall be reduced below the stated values in paragraphs (b)(1), (b)(2), and (b)(3) of this section, as appropriate, by the amount in dB that the directional gain of the antenna exceeds 6 dBi.

Test Result

The maximum gain of antenna was 2.32dBi with impedance 50Ω.

4 Test Setup Photographs of EUT

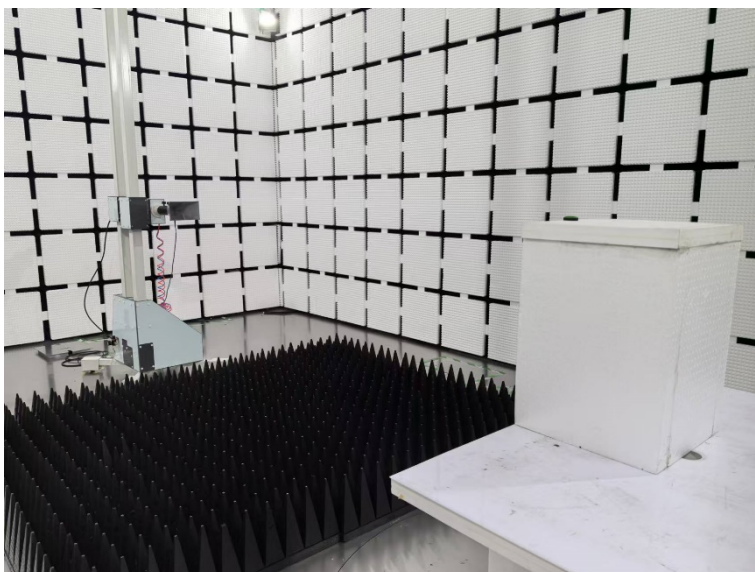
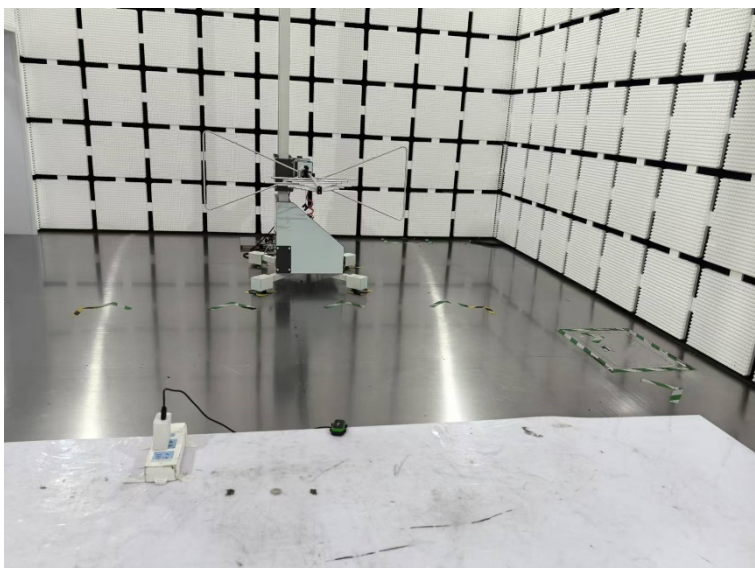

5 External Photographs of EUT

