

APPLICATION FOR CERTIFICATION
On Behalf of

Vision Electronics Co., Ltd.

PS2 2.4G RF Wireless Controller

Model Number: 2404/G7090

Prepared for : Vision Electronics Co., Ltd.
11F-6, No.400 Huan Pei Rd., Chung Li City,
Tai Wan, R.O.C.

Prepared By : Audix Technology (Shenzhen) Co., Ltd.
No. 6, Ke Feng Rd., 52 Block,
Shenzhen Science & Industrial Park,
Nantou, Shenzhen, Guangdong, China

Tel: (0755) 26639496

Report Number : ACS-F03114
Date of Test : Apr. 21~23, 2003
Date of Report : Jun. 03, 2003

TABLE OF CONTENTS

Description	Page
FCC Test Report for Declaration of Conformity	
1. GENERAL INFORMATION	1-1
1.1. Description of Device (EUT)	1-1
1.2. Tested Supporting System Details.....	1-1
1.3. Test Facility	1-2
1.4. Test Uncertainty	1-2
2. POWER LINE CONDUCTED EMISSION TEST	2-1
2.1. Test Equipment.....	2-1
2.2. Block Diagram of Test Setup	2-1
2.3. Power Line Conducted Emission Test Limits	2-1
2.4. Configuration of EUT on Test.....	2-2
2.5. Operating Condition of EUT	2-2
2.6. Test Procedure	2-2
2.7. Power Line Conducted Emission Test Results.....	2-3
3. RADIATED EMISSION TEST	3-1
3.1. Test Equipment.....	3-1
3.2. Block Diagram of Test Setup	3-1
3.3. Radiated Emission Limit	3-2
3.4. EUT Configuration on Test	3-2
3.5. Operating Condition of EUT	3-3
3.6. Test Procedure	3-3
3.7. Radiated Emission Test Result.....	3-4
4. 6dB BANDWIDTH MEASUREMENT	4-1
4.1. Test Equipment.....	4-1
4.2. Block Diagram of Test Setup	4-1
4.3. Specification Limits (§15.247(a)(2)).....	4-1
4.4. Operating Condition of EUT	4-1
4.5. Test Procedure	4-2
4.6. Test Results	4-2
5. PEAK OUTPUT POWER MEASUREMENT	5-1
5.1. Test Equipment.....	5-1
5.2. Block Diagram of Test Setup	5-1
5.3. Specification Limits (§15.247(b)-(3))	5-1
5.4. Operating Condition of EUT	5-1
5.5. Test Procedure	5-2
5.6. Test Results	5-2
6. BAND EDGES MEASUREMENT	6-1
6.1. Test Equipment.....	6-1
6.2. Block Diagram of Test Setup	6-1
6.3. Specification Limits (§15.247(c))	6-1
6.4. Operating Condition of EUT	6-1
6.5. Test Procedure	6-2
6.6. Test Results	6-2
7. POWER SPECTRAL DENSITY MEASUREMENT.....	7-1
7.1. Test Equipment.....	7-1
7.2. Block Diagram of Test Setup	7-1

7.3.	Specification Limits (§15.247(d))	7-1
7.4.	Operating Condition of EUT	7-1
7.5.	Test Procedure	7-2
7.6.	Test Results	7-2
8.	MAXIMUM PERMISSIBLE EXPOSURE	8-1
9.	DEVIATION TO TEST SPECIFICATIONS.....	9-1
10.	PHOTOGRAPH	10-1
10.1.	Photos of Power Line Conducted Emission Test	10-1
10.2.	Photos of Radiated Emission Test (In Anechoic Chamber)	10-2
10.3.	Photos of Peak Output Power Measurement	10-5
10.4.	Photos of Power Spectral Density Measurement	10-5

APPENDIX I	(5 pages)
APPENDIX II	(13 pages)

TEST REPORT DECLARATION

Applicant : Vision Electronics Co., Ltd.
 Manufacturer : Vision Electronics Co., Ltd.
 EUT Description : PS2 2.4G RF Wireless Controller
 (A) MODEL NO. : 2404/G7090
 (B) SERIAL NO. : F2003060301
 (C) POWER SUPPLY : 2404: DC 6V
 G7090: DC 3V

Test Procedure Used:
 FCC Rules and Regulations Part 15 Subpart C Aug 2002.

The device described above is tested by AUDIX TECHNOLOGY (SHENZHEN) CO., LTD. to determine the maximum emission levels emanating from the device. The maximum emission levels are compared to the FCC Part 15 Subpart C limits both radiated and conducted emissions.

The test results are contained in this test report and AUDIX TECHNOLOGY (SHENZHEN) CO., LTD. is assumed full responsibility for the accuracy and completeness of these tests. Also, this report shows that the Equipment Under Test (EUT) is to be technically compliant with the FCC requirements.

This report applies to above tested sample only. This report shall not be reproduced in part without written approval of AUDIX TECHNOLOGY (SHENZHEN) CO., LTD.

This report must not be used by the applicant to claim product endorsement by NVLAP or any agency of the U.S. Government.

Date of Test : Apr.21~23, 2003

Prepared by : Jane Dai
 Jane Dai / Assistant

Reviewer : Lake Wang
 Lake Wang / Supervisor

Approved & Authorized Signer : Alex Deng
 For and on behalf of
 AUDIX TECHNOLOGY (SHENZHEN) CO.,LTD.
 Alex Deng (Authorized Signatures)

Name of the Representative of the Responsible Party : _____

Signature : _____

1. GENERAL INFORMATION

1.1. Description of Device (EUT)

Description	:	PS2 2.4G RF Wireless Controller (Note: The receiver and EUT are separate, and the receivers are not part of this application for certification.)
Modulation Technique	:	DSSS
Range With -5dBi antenna	:	>10m (~33ft) indoor
Model Number	:	2404/G7090 (Between the two model 2404 & G7090 the electric circuit are same just the layout and appearance are different.)
Applicant	:	Vision Electronics Co., Ltd. 11F-6, No.400 Huan Pei Rd., Chung Li City, Tai Wan, R.O.C.
Manufacturer	:	Vision Electronics Co., Ltd. 11F-6, No.400 Huan Pei Rd., Chung Li City, Tai Wan, R.O.C.
Date of Test	:	Apr. 21~23, 2003

1.2. Tested Supporting System Details

Play Station 2	:	Manufacturer: SONY M/N: SCPH-30001 S/N: U1567971 Data Cable: Shielded, Detachable, 1.8m Power Cord: Unshielded, Detachable, 1.5m
Receiver	:	Manufacturer: Vision M/N: 2474/2476

1.3. Test Facility

Site Description

3m Anechoic Chamber : Certificated by FCC, USA
Aug. 24, 2000

EMC Lab. : Certificated by DATech, German
Feb. 02, 1999

Certificated by NVLAP, USA
NVLAP Code: 200372-0
Mar. 31, 2003

Name of Firm : Audix Technology (Shenzhen) Co., Ltd.

Site Location : No. 6, Ke Feng Rd., 52 Block,
Shenzhen Science & Industrial Park,
Nantou, Shenzhen, Guangdong, China

1.4. Test Uncertainty

Conducted Emission Uncertainty = $\pm 2.66\text{dB}$

Radiated Emission Uncertainty = $\pm 4.26\text{dB}$

2. POWER LINE CONDUCTED EMISSION TEST

2.1. Test Equipment

The following test equipments are used during the power line conducted emission test:

Item	Equipment	Manufacturer	Model No.	Serial No.	Last Cal.	Cal. Interval
1.	Test Receiver	Rohde & Schwarz	ESHS20	836600/006	Jun. 02, 02	1 Year
2.	L.I.S.N. #1	Kyoritsu	KNW-407	8-541-4	Jun. 02, 02	1 Year
3.	L.I.S.N. #2	R&S	ESH2-Z5	834066/011	Jun. 02, 02	1 Year
4.	Terminator	EMCO	50Ω	No. 1	Jun. 02, 02	1 Year
5.	Terminator	EMCO	50Ω	No. 2	Jun. 02, 02	1 Year
6.	RF Cable	FUJIKURA	RG-55/U	LISN Cable	Feb. 22, 03	1/2 Year
7.	Coaxial Switch	Anritsu	MP59B	M74389	Nov. 30, 02	1/2 Year
8.	PC	N/A	586ATXS	N/A	N/A	N/A
9.	Printer	HP	Laserjet2100	SGGJ092351	N/A	N/A

2.2. Block Diagram of Test Setup

2.2.1. Block diagram of connection between the EUT and simulators

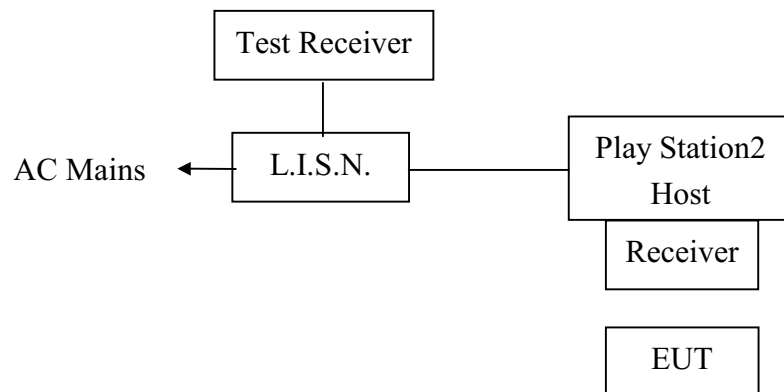

(EUT: PS2 2.4G RF Wireless Controller)

2.3. Power Line Conducted Emission Test Limits

Frequency	Maximum RF Line Voltage	
	Quasi-Peak Level dB(μV)	Average Level dB(μV)
150KHz ~ 500KHz	66 ~ 56*	56 ~ 46*
500KHz ~ 5MHz	56	46
5MHz ~ 30MHz	60	50

Notes: 1. * Decreasing linearly with logarithm of frequency.

2. The lower limit shall apply at the transition frequencies.

2.4.Configuration of EUT on Test

The following equipment are installed on Power Line Conducted Emission Test to meet the commission requirement and operating regulations in a manner which tends to maximize its emission characteristics in a normal application.

2.4.1.PS2 2.4G RF Wireless Controller (EUT)

Model Number : 2404/G7090
Serial Number : F2003060301
Manufacturer : Vision Electronics Co., Ltd.

2.4.2.Support Equipment : As Tested Supporting System Detail, in Section 1.2..

2.5.Operating Condition of EUT

2.5.1.Setup the EUT and simulator as shown as Section 2.2.

2.5.2.Turn on the power of all equipment.

2.5.3.Let the EUT work in test mode (Running) and test it.

2.6.Test Procedure

The play station2 is connected to the power mains through a line impedance stabilization network (L.I.S.N.). This provides a 50 ohm coupling impedance for the play station2. Please refer the block diagram of the test setup and photographs. Power on the EUT and let it work normally, we use a keyboard test soft ware, let EUT working in test mode, then test it. Both sides of AC line are checked to find out the maximum conducted emission. In order to find the maximum emission levels, the relative positions of equipment and all of the interface cables shall be changed according to FCC ANSI C63.4-1992 on Conducted Emission Test.

The bandwidth of test receiver (R & S ESHS20) is set at 10KHz.

The frequency range from 150KHz to 30MHz is checked.

The test result are reported on Section 2.7., all the scanning waveforms for Conducted Emission Test are attached in Appendix I.

2.7.Power Line Conducted Emission Test Results

PASS.

The frequency range from 150KHz to 30 MHz is investigated.

All emissions not reported below are too low against the prescribed limits.

Date of Test	: Apr. 22, 2003	Temperature	: 24.6°C
EUT	: PS2 2.4G RF Wireless Controller	Humidity	: 54%
Model No.	: Controller: 2404, Receiver: 2474	Test Mode	: Running
Test Engineer	: Sean Xing		

Frequency (MHz)	Reading (dB μ V)				Limit (dB μ V)	
	VA		VB		Quasi-Peak	Average
	Quasi-Peak	Average	Quasi-Peak	Average		
0.154	*	*	57.79	51.19	65.78	55.78
0.156	57.14	51.44	*	*	65.69	55.69
0.184	*	*	41.66	34.26	64.28	54.28
0.189	42.14	37.54	*	*	64.06	54.06
0.323	38.77	33.17	*	*	59.62	49.62
0.327	*	*	39.27	31.47	59.53	49.53
0.339	*	*	38.96	33.16	59.22	49.22
0.476	*	*	29.32	24.32	56.41	46.41
0.486	29.30	23.60	*	*	56.23	46.23
1.262	25.36	20.15	*	*	56.00	46.00
2.622	23.64	15.64	*	*	56.00	46.00
4.269	*	*	22.95	17.65	56.00	46.00

"*" As the QP value is too low against AV limit, So AV Value had been omitted.

Reviewer:

Caife Wang

Date of Test : Apr. 22, 2003 Temperature : 24.6°C
 EUT : PS2 2.4G RF Wireless Controller Humidity : 54%
 Model No. : Controller: G7090, Receiver: 2476 Test Mode : Running
 Test Engineer : Sean Xing

Frequency (MHz)	Reading (dBμV)				Limit (dBμV)	
	VA		VB		Quasi-Peak	Average
	Quasi-Peak	Average	Quasi-Peak	Average		
0.157	*	*	60.46	52.46	65.62	55.62
0.161	55.29	51.99	*	*	65.41	55.41
0.317	*	*	40.17	32.47	59.79	49.79
0.342	41.06	33.16	*	*	59.15	49.15
0.466	32.20	25.30	33.32	26.12	56.58	46.48
0.835	*	*	33.07	26.47	56.00	46.00
1.800	*	*	40.14	35.74	56.00	46.00
1.832	31.24	23.54	*	*	56.00	46.00
3.350	32.45	26.05	*	*	56.00	46.00
3.881	*	*	29.95	21.85	56.00	46.00
3.920	32.64	26.94	*	*	56.00	46.00

"*" As the QP value is too low against AV limit, So AV Value had been omitted.

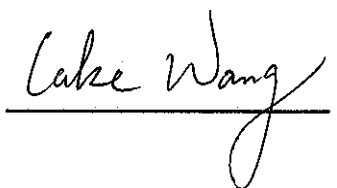
Reviewer: 

3. RADIATED EMISSION TEST

3.1. Test Equipment

The following test equipments are used during the radiated emission test:

3.1.1. For Anechoic Chamber

Item	Equipment	Manufacturer	Model No.	Serial No.	Last Cal.	Cal. Interval
1.	EMI Spectrum	HP	85422E	3625A00181	Jun. 02, 02	1 Year
2.	Test Receiver	Rohde & Schwarz	ESVS10	834468/011	Jun. 02, 02	1 Year
3.	Amplifier	HP	8447D	2944A07794	Mar. 19, 03	1/2 Year
4.	Bilog Antenna	Schaffner	CBL6111C	2598	Jan. 14, 03	1 Year
5.	PC	N/A	586ATX3	N/A	N/A	N/A
6.	Printer	HP	Laserjet6P	SGCF019673	N/A	N/A
7.	RF Cable	MIYAZAKI	5D-2W	3# Chamber No.1	Feb. 03, 03	1/2 Year
8.	RF Cable	MIYAZAKI	5D-2W	3# Chamber No.2	Feb. 03, 03	1/2 Year
9.	RF Cable	FUJIKURA	RG-55/U	3# Chamber No.3	Feb. 03, 03	1/2 Year
10.	RF Cable	FUJIKURA	RG-55/U	3# Chamber No.4	Feb. 03, 03	1/2 Year
11.	Coaxial Switch	Anritsu	MP59B	M73989	Nov. 30, 02	1/2 Year
12.	Spectrum	Agilent	E4407B	MY41440292	Mar. 28, 03	1 Year
13.	Amp	HP	8449B	3008A00863	Jun. 02, 02	1 Year
14.	Antenna	EMCO	3115	9607-4877	Dec. 04, 02	1.5 Year

3.2. Block Diagram of Test Setup

3.2.1. Block diagram of connection between the EUT and simulators

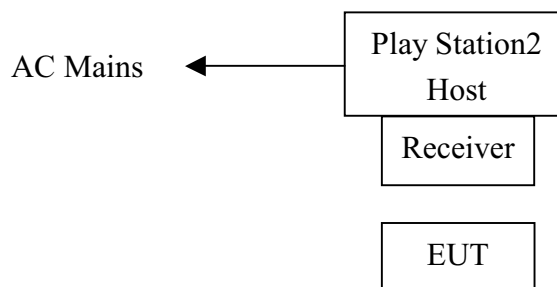

(EUT: PS2 2.4G RF Wireless Controller)

3.2.2. In Anechoic Chamber

ANTENNA TOWER

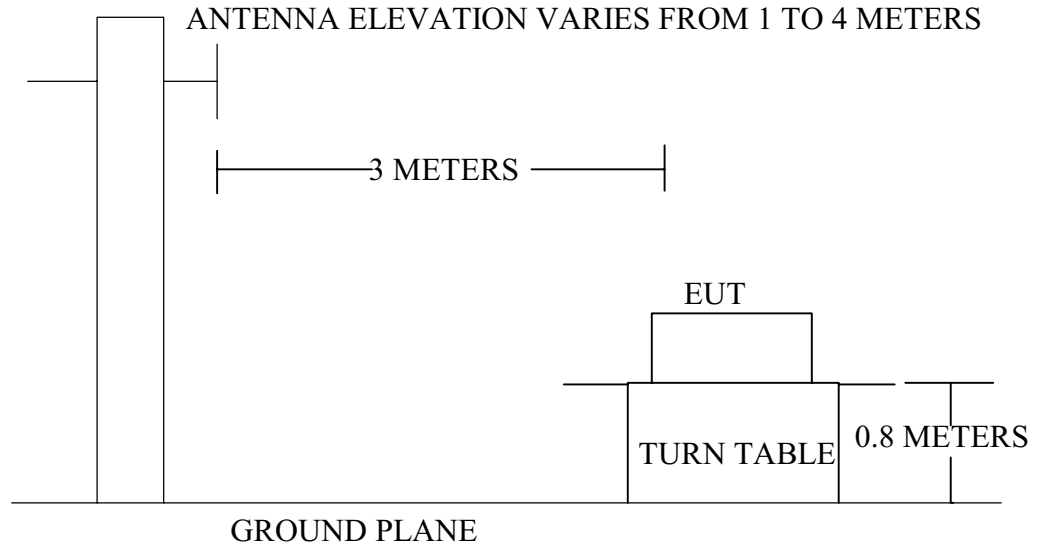

3.3. Radiated Emission Limit

FREQUENCY MHz	DISTANCE Meters	FIELD STRENGTHS LIMIT	
		$\mu\text{V}/\text{m}$	$\text{dB}(\mu\text{V})/\text{m}$
30 ~ 88	3	100	40.0
88 ~ 216	3	150	43.5
216 ~ 960	3	200	46.0
960 ~ 1000	3	500	54.0
Above 1000	3	74.0 $\text{dB}(\mu\text{V})/\text{m}$ (Peak) 54.0 $\text{dB}(\mu\text{V})/\text{m}$ (Average)	

- Remark :
- (1) Emission level $(\text{dB})\mu\text{V} = 20 \log$ Emission level $\mu\text{V}/\text{m}$
 - (2) The smaller limit shall apply at the cross point between two frequency bands.
 - (3) Distance is the distance in meters between the measuring instrument, antenna and the closest point of any part of the device or system.

3.4. EUT Configuration on Test

The following equipment are installed on Radiated Emission Test to meet the commission requirements and operating regulations in a manner which tends to maximize its emission characteristics in normal application.

3.4.1. PS2 2.4G RF Wireless Controller (EUT)

Model Number : 2404/G7090
 Serial Number : F2003060301
 Manufacturer : Vision Electronics Co., Ltd.

3.4.2. Support Equipment : As Tested Supporting System Detail, in Section 1.2.

3.5.Operating Condition of EUT

1. Setup the EUT as shown in Section 3.2..
2. Let the EUT work in test mode (Running) and test it.

3.6.Test Procedure

EUT and its simulators are placed on a turn table, which is 0.8 meter high above ground. The turn table can rotate 360 degrees to determine the position of the maximum emission level. Power on the EUT and let it work normally, we use a keyboard test soft ware, let EUT working in test mode, then test it. EUT is set 3 meters away from the receiving antenna, which is mounted on a antenna tower. The antenna can be moved up and down between 1 meter and 4 meters to find out the maximum emission level. Broadband antenna (calibrated bilog antenna) is used as receiving antenna. Both horizontal and vertical polarization of the antenna are set on test.

The bandwidth of the EMI test receiver (R&S ESVS20) is set at 120KHz.

The frequency range from 30MHz to 24.44GHz is checked.

The test mode (Running) is tested in Anechoic Chamber, and all the scanning waveforms are attached in Appendix II.

3.7.Radiated Emission Test Result

PASS.

The frequency range from 30MHz to 1000MHz is investigated.
Please see the following pages.

Date of Test :	<u>Apr. 23, 2003</u>	Temperature :	<u>23°C</u>
EUT :	<u>PS2 2.4G RF Wireless Controller</u>	Humidity :	<u>58%</u>
Model No. :	<u>Controller: 2404, Receiver: 2474</u>	Test Mode :	<u>Running</u>
Test Engineer:	<u>Sean Xing</u>		

Frequency MHz	Antenna Factor dB/m	Cable Loss dB	Meter Reading Horizontal dB μ V	Emission Level Horizontal dB μ V/m	Over Limits dB	Limits dB μ V/m
203.630	9.74	3.04	24.90	37.68	-5.82	43.50
295.780	13.19	3.76	22.80	39.75	-6.25	46.00
392.780	16.10	4.54	22.10	42.74	-3.26	46.00
589.690	18.84	6.14	15.10	40.08	-5.92	46.00
785.630	21.60	7.02	13.20	41.82	-4.18	46.00
884.570	22.12	7.42	9.70	39.23	-6.77	46.00

Remark: 1. All readings are Quasi-Peak values.

2. Emission Level = Antenna Factor + Cable Loss + Meter Reading

3. The worst emission was detected at 392.780MHz with corrected signal level of 42.74dB μ V/m(Limit is 46.00 dB μ V/m) when the antenna was at horizontal polarization and at 1.8m high and the turn table was at 220 ° .

4. 0 ° was the table front facing the antenna. Degree is calculated from 0 ° clockwise facing the antenna.

Reviewer:

Caife Wang

Date of Test :	<u>Apr. 23, 2003</u>	Temperature :	<u>23°C</u>
EUT :	<u>PS2 2.4G RF Wireless Controller</u>	Humidity :	<u>58%</u>
Model No. :	<u>Controller: 2404, Receiver: 2474</u>	Test Mode :	<u>Running</u>
Test Engineer:	<u>Sean Xing</u>		

Frequency MHz	Antenna Factor dB/m	Cable Loss dB	Meter Reading Vertical dB μ V	Emission Level Vertical dB μ V/m	Over Limits dB	Limits dB μ V/m
111.480	11.79	2.06	22.00	35.85	-7.65	43.50
295.780	13.58	3.76	22.80	40.14	-5.86	46.00
480.080	18.13	5.35	15.80	39.28	-6.72	46.00
591.630	19.44	6.27	15.00	40.71	-5.29	46.00
737.130	21.58	6.74	13.20	41.52	-4.48	46.00
884.570	23.51	7.42	11.30	42.23	-3.77	46.00

Remark: 1. All readings are Quasi-Peak values.

2. Emission Level = Antenna Factor + Cable Loss + Meter Reading

3. The worst emission was detected at 884.570MHz with corrected signal level of 42.23dB μ V/m(Limit is 46.00 dB μ V/m) when the antenna was at horizontal polarization and at 1.0m high and the turn table was at 190 ° .

4. 0 ° was the table front facing the antenna. Degree is calculated from 0 ° clockwise facing the antenna.

Reviewer:

Case Wang

Date of Test : Apr. 23, 2003 Temperature : 23°C
 EUT : PS2 2.4G RF Wireless Controller Humidity : 58%
 Model No. : Controller: G7090, Test Mode : Running
Receiver: 2476
 Test Engineer: Sean Xing

Frequency MHz	Antenna Factor dB/m	Cable Loss dB	Meter Reading Horizontal dBμV	Emission Level Horizontal dBμV/m	Over Limits dB	Limits dBμV/m
203.580	9.74	3.04	24.80	37.58	-5.92	43.50
295.720	13.19	3.76	23.80	40.75	-5.25	46.00
392.800	16.10	4.54	21.90	42.54	-3.46	46.00
589.740	18.84	6.14	15.20	40.18	-5.82	46.00
785.600	21.60	7.02	13.10	41.73	-4.27	46.00
884.550	22.12	7.42	9.70	39.23	-6.77	46.00

Remark: 1. All readings are Quasi-Peak values.

2. Emission Level = Antenna Factor + Cable Loss + Meter Reading

Reviewer: *Chae Wang*

Date of Test : Apr. 23, 2003 Temperature : 23°C
 EUT : PS2 2.4G RF Wireless Controller Humidity : 58%
 Model No. : Controller: G7090, Test Mode : Running
Receiver: 2476
 Test Engineer: Sean Xing

Frequency MHz	Antenna Factor dB/m	Cable Loss dB	Meter Reading Vertical dBμV	Emission Level Vertical dBμV/m	Over Limits dB	Limits dBμV/m
111.475	11.79	2.06	46.00	35.30	-8.20	43.50
295.880	13.58	3.76	48.00	41.12	-4.88	46.00
480.110	18.13	5.35	42.10	39.74	-6.26	46.00
588.750	19.26	6.08	42.10	41.23	-4.77	46.00
808.950	21.45	6.91	39.10	41.25	-4.75	46.00
884.600	23.51	7.42	35.90	41.14	-4.86	46.00

Remark: 1. All readings are Quasi-Peak values.

2. Emission Level = Antenna Factor + Cable Loss + Meter Reading

Reviewer:

Caife Wang

Date of Test :	<u>Apr. 21, 2003</u>	Temperature :	<u>23°C</u>
EUT :	<u>PS2 2.4G RF Wireless Controller</u>	Humidity :	<u>58%</u>
Model No. :	<u>Controller: 2404</u>	Test Mode :	<u>Running</u>
Test Engineer:	<u>Sean Xing</u>		

Frequency MHz	Antenna Factor dB	Preamp Factor dB	Cable Loss dB	Meter Reading Horizontal dBμV	Emission Level Horizontal dBμV/m	Over Limits dB	Limits dBμV/m	Remark
1180.000	23.88	35.52	3.36	63.59	55.31	-18.69	74.00	Peak
1179.500	23.88	35.52	3.36	54.03	45.75	-28.25	54.00	Average
2440.000	28.14	34.98	5.74	74.33	73.23	-	-	Peak
2440.000	28.14	34.98	5.74	64.40	63.30	-	-	Average
4883.000	33.08	34.46	8.01	48.85	55.48	-18.52	74.00	Peak
4883.000	33.08	34.46	8.01	35.30	41.93	-32.07	54.00	Average

Remark: 1. All readings are Peak and Average values.

2. Emission Level = Antenna Factor + Cable Loss + Meter Reading– Preamp Factor

3. The bandwidth of the RBW is set at 1MHz and VBW is set at 1MHz.

Frequency MHz	Antenna Factor dB	Preamp Factor dB	Cable Loss dB	Meter Reading Vertical dBμV	Emission Level Vertical dBμV/m	Over Limits dB	Limits dBμV/m	Remark
1180.000	23.88	35.52	3.36	69.63	61.35	-12.65	74.00	Peak
1180.000	23.88	35.52	3.36	59.36	51.08	-22.92	54.00	Average
2440.000	28.14	34.98	5.74	67.80	66.70	-	-	Peak
2440.000	28.14	34.98	5.74	59.78	58.68	-	-	Average
4883.000	33.08	34.46	8.01	43.52	50.15	-23.85	74.00	Peak
4883.000	33.08	34.46	8.01	27.36	33.99	-40.01	54.00	Average

Remark: 1. All readings are Peak and Average values.

2. Emission Level = Antenna Factor + Cable Loss + Meter Reading– Preamp Factor

3. The bandwidth of the RBW is set at 1MHz and VBW is set at 1MHz.

Reviewer:

Calke Wang

Date of Test :	<u>Apr. 22, 2003</u>	Temperature :	<u>23°C</u>
EUT :	<u>PS2 2.4G RF Wireless Controller</u>	Humidity :	<u>58%</u>
Model No. :	<u>Controller: G7090</u>	Test Mode :	<u>Running</u>
Test Engineer:	<u>Sean Xing</u>		

Frequency MHz	Antenna Factor dB	Preamp Factor dB	Cable Loss dB	Meter Reading Horizontal dBμV	Emission Level Horizontal dBμV/m	Over Limits dBμV/m	Limits dBμV/m	Remark
1180.000	23.88	35.52	3.36	61.63	53.35	-20.65	74.00	Peak
1180.000	23.88	35.52	3.36	59.73	51.45	-22.55	54.00	Average
2440.000	28.14	34.98	5.74	72.30	71.20	-	-	Peak
2440.000	28.14	34.98	5.74	62.26	61.16	-	-	Average

Remark: 1. All readings are Peak and Average values.

2. Emission Level = Antenna Factor + Cable Loss + Meter Reading– Preamp Factor

3. The bandwidth of the RBW is set at 1MHz and VBW is set at 1MHz.

Frequency MHz	Antenna Factor dB	Preamp Factor dB	Cable Loss dB	Meter Reading Vertical dBμV	Emission Level Vertical dBμV/m	Over Limits dBμV/m	Limits dBμV/m	Remark
1180.000	23.88	35.52	3.36	68.97	60.69	-13.31	74.00	Peak
1180.000	23.88	35.52	3.36	57.40	49.12	-24.88	54.00	Average
2440.000	28.14	34.98	5.74	72.13	71.03	-	-	Peak
2440.000	28.14	34.98	5.74	62.99	61.89	-	-	Average
4881.000	33.08	34.46	8.01	46.41	53.04	-20.96	74.00	Peak
4881.000	33.08	34.46	8.01	31.46	38.09	-35.91	54.00	Average

Remark: 1. All readings are Peak and Average values.

2. Emission Level = Antenna Factor + Cable Loss + Meter Reading– Preamp Factor

3. The bandwidth of the RBW is set at 1MHz and VBW is set at 1MHz.

Reviewer:

Caixi Wang



AUDIX TECHNOLOGY (SHENZHEN) CO., LTD.

Shenzhen Science & Ind. Park
 Tel: 0755-26639495~7
 Fax: 0755-26632877

Data#: 10 File#: Vision.EMI Date: 2003-04-23 Time: 22:28:17

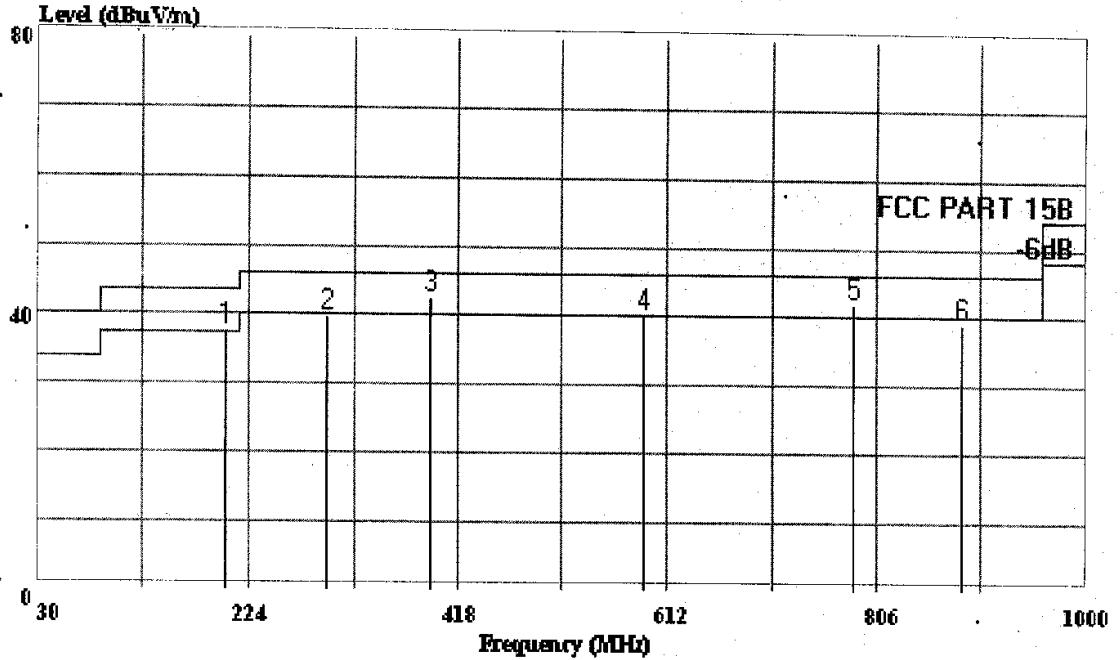

AUDIX TECHNOLOGY (SHENZHEN) CO., LTD. (# Chamber)

Trace:

Ref Trace:

Condition: FCC PART 15B 3m 2598FACTOR HORIZONTAL
 EUT : PS2 2.4G RF Wireless Controller
 M/N : Controller: 2404. Receiver: 2474
 Power : Host 120V/60Hz DC 6V
 Test Engineer: Sean Xing
 Comment : Temp: 23' C, Humi: 58%
 Memo : Running
 : Freq: 392.780MHz
 : Ant Pos: 1.8m, T-Table Pos: 220 degree

Page: 1

	Freq	Level	Limit	Over	Read	Probe	Cable
	MHz	dBuV/m	Line	Limit	Level	Factor	Loss
			dBuV/m	dB	dBuV	dB	dB
1 !	203.630	37.68	43.50	-5.82	24.90	9.74	3.04
2	295.780	39.75	46.00	-6.25	22.80	13.19	3.76
3 !	392.780	42.74	46.00	-3.26	22.10	16.10	4.54
4 !	589.690	40.08	46.00	-5.92	15.10	18.84	6.14
5 !	785.630	41.82	46.00	-4.18	13.20	21.60	7.02
6	884.570	39.23	46.00	-6.77	9.70	22.12	7.42



AUDIX TECHNOLOGY (SHENZHEN) CO., LTD.

Shenzhen Science & Ind. Park
 Tel: 0755-26639495~7
 Fax: 0755-26632877

Data#: 12 File#: Vision.EMI Date: 2003-04-23 Time: 22:45:08

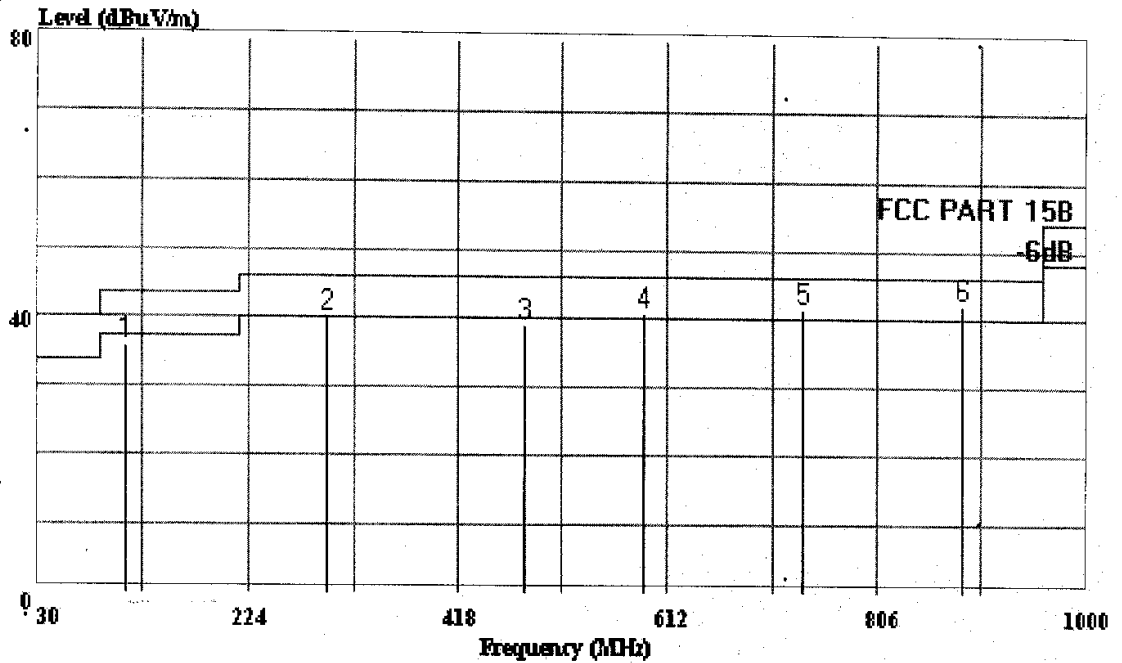

AUDIX TECHNOLOGY (SHENZHEN) CO., LTD. (3# Chamber)

Trace:

Ref Trace:

Condition: FCC PART 15B 3m 2598FACTOR VERTICAL
 EUT : PS2 2.4G RF Wireless Controller
 M/N : Controller: 2404. Receiver: 2474
 Power : Host 120V/60Hz DC 6V
 Test Engineer: Sean Xing
 Comment : Temp: 23' C, Humi: 58%
 Memo : Running
 : Freq: 884.557MHz
 : Ant Pos: 1.0m, T-Table Pos: 190 degree

Page: 1

	Freq	Level	Limit	Over	Read	Probe	Cable
	MHz	dBuV/m	dBuV/m	Limit	Level	Factor	Loss
				dB	dBuV	dB	dB
1	111.480	35.85	43.50	-7.65	22.00	11.79	2.06
2 !	295.780	40.14	46.00	-5.86	22.80	13.58	3.76
3	480.080	39.28	46.00	-6.72	15.80	18.13	5.35
4 !	591.630	40.71	46.00	-5.29	15.00	19.44	6.27
5 !	737.130	41.52	46.00	-4.48	13.20	21.58	6.74
6 !	884.570	42.23	46.00	-3.77	11.30	23.51	7.42



AUDIX TECHNOLOGY (SHENZHEN) CO., LTD.

Shenzhen Science & Ind. Park
 Tel: 0755-26639495-7
 Fax: 0755-26632877

Data#: 16 File#: Vision.EMI Date: 2003-04-23 Time: 23:33:08

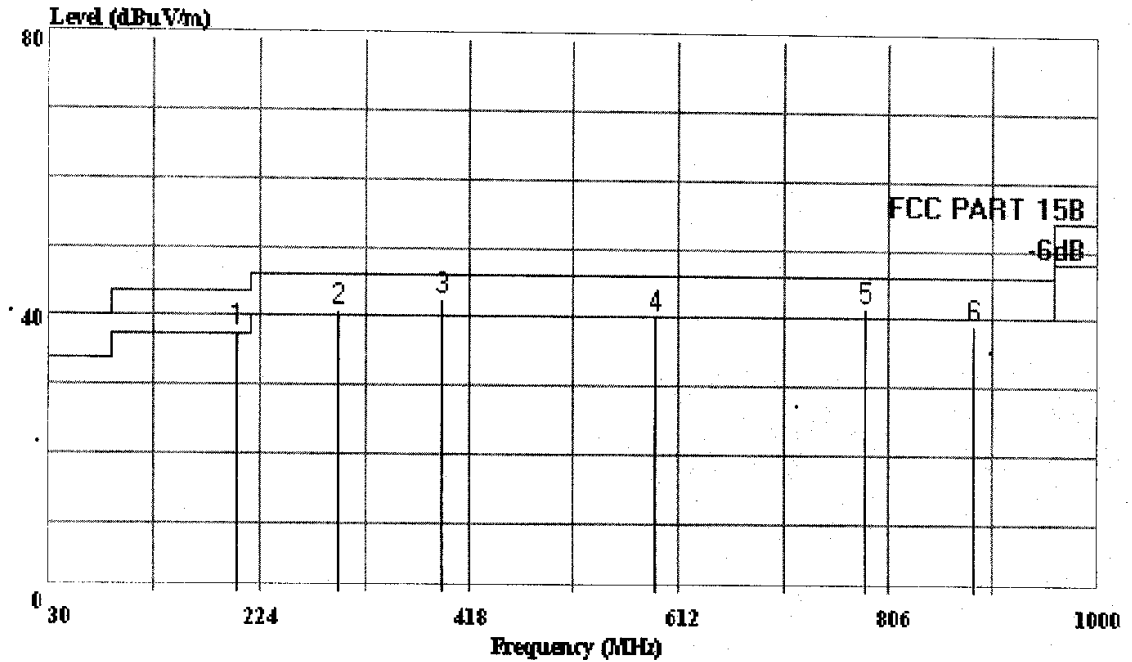

AUDIX TECHNOLOGY (SHENZHEN) CO., LTD. (3# Chamber)

Trace:

Ref Trace:

Condition: FCC PART 15B 3m 2598FACTOR HORIZONTAL
 EUT : PS2 2.4G RF Wireless Controller
 M/N : Controller: G7090. Receiver: 2476
 Power : Host 120V/60Hz DC 3V
 Test Engineer: Sean Xing
 Comment : Temp: 23' C Humi: 58%
 Memo : Running

Page: 1

	Freq	Level	Limit	Over	Read	Probe	Cable
	MHz	dBuV/m	Line	Limit	Level	Factor	Loss
			dBuV/m	dB	dBuV	dB	dB
1 !	203.580	37.58	43.50	-5.92	24.80	9.74	3.04
2 !	295.720	40.75	46.00	-5.25	23.80	13.19	3.76
3 !	392.800	42.54	46.00	-3.46	21.90	16.10	4.54
4 !	589.740	40.18	46.00	-5.82	15.20	18.84	6.14
5 !	785.600	41.73	46.00	-4.27	13.10	21.60	7.02
6	884.550	39.23	46.00	-6.77	9.70	22.12	7.42



AUDIX TECHNOLOGY (SHENZHEN) CO., LTD.

Shenzhen Science & Ind. Park
 Tel: 0755-26639495~7
 Fax: 0755-26632877

Data#: 14 File#: Vision.EMI Date: 2003-04-23 Time: 23:00:46

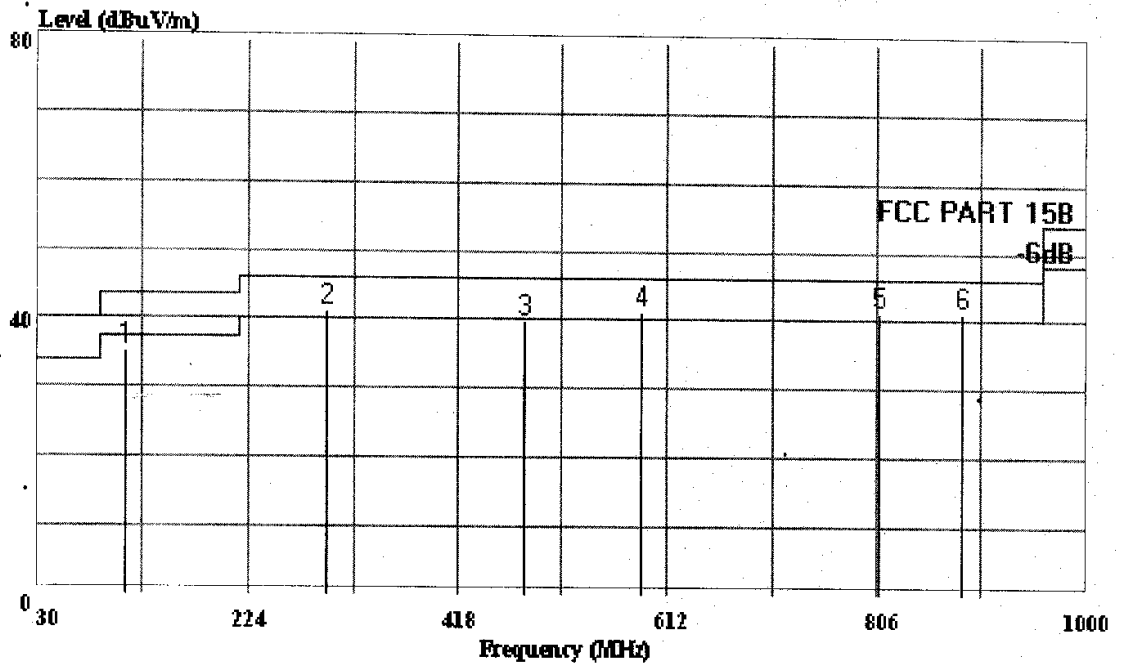

AUDIX TECHNOLOGY (SHENZHEN) CO., LTD. (3# Chamber)

Trace:

Ref Trace:

Condition: FCC PART 15B 3m 2598FACTOR VERTICAL
 EUT : PS2 2.4G RF Wireless Controller
 M/N : Controller: G7090. Receiver: 2476
 Power : Host 120V/60Hz DC 3V
 Test Engineer: Sean Xing
 Comment : Temp: 23' C, Humi: 28%
 Memo : Running

Page: 1

	Freq	Level	Limit	Over	Read	Probe	Cable
	MHz	dBuV/m	Line	Limit	Level	Factor	Loss
			dBuV/m	dB	dBuV	dB	dB
1	111.475	35.30	43.50	-8.20	46.00	11.79	2.06
2 !	295.880	41.12	46.00	-4.88	48.00	13.58	3.76
3	480.110	39.74	46.00	-6.26	42.10	18.13	5.35
4 !	588.750	41.23	46.00	-4.77	42.10	19.26	6.08
5 !	808.950	41.25	46.00	-4.75	39.10	21.45	6.91
6 !	884.600	41.14	46.00	-4.86	35.90	23.51	7.42

4. 6dB BANDWIDTH MEASUREMENT

4.1. Test Equipment

The following test equipment were used during the Emission Bandwidth Test :

Item	Equipment	Manufacturer	Model No.	Serial No.	Last Cal.	Cal. Interval
1.	Spectrum	Agilent	E4407B	MY41440292	Mar.28, 03	1 Year
2.	Amp	HP	8449B	3008A00863	Jun.02, 02	1 Year
3.	Antenna	EMCO	3115	9607-4877	Dec. 04, 02	1.5 Year
4.	HF Cable	Hubersuhne	Sucoflex104	-	Jun.02, 02	1 Year

4.2. Block Diagram of Test Setup

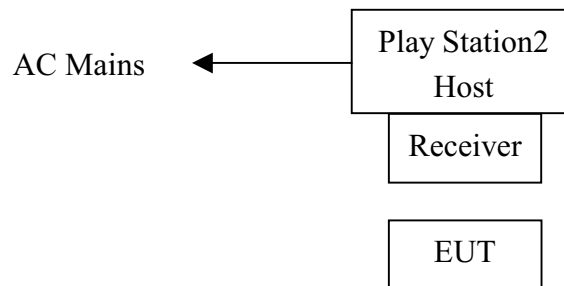

(EUT: PS2 2.4G RF Wireless Controller)

4.3. Specification Limits (§15.247(a)(2))

The minimum 6dB bandwidth shall be at least 500kHz.

4.4. Operating Condition of EUT

1. Setup the EUT as shown in Section 4.2..
2. Let the EUT work in test mode (Running) and test it.

4.5. Test Procedure

EUT and its simulators are placed on a turn table, which is 0.8 meter high above ground. Power on the EUT and let it work normally, we use a keyboard test software, let EUT working in test mode, then test it. EUT is set 3 meters away from the receiving antenna, which is mounted on a antenna tower. The antenna can be moved up and down between 1 meter and 4 meters to find out the maximum emission level. Horn antenna is used as receiving antenna.

The bandwidth of the fundamental frequency was measure by spectrum analyzer with 100kHz RBW and 100kHz VBW. The 6dB bandwidth is defined as the total spectrum the power of which is higher than peak power minus 6dB.

4.6. Test Results

PASSED.

The testing data was attached in the next pages.

Date of Test :	<u>Apr. 23, 2003</u>	Temperature :	<u>23°C</u>
EUT :	<u>PS2 2.4G RF Wireless Controller</u>	Humidity :	<u>58%</u>
Model No. :	<u>Controller: 2404</u>	Test Mode :	<u>Running</u>
Test Engineer:	<u>Sean Xing</u>		

<u>Channel.</u>	<u>Frequency</u>	<u>6dB Bandwidth</u>
<u>1</u>	<u>2.44080GHz</u>	<u>11.40MHz</u>

Date of Test :	<u>Apr. 23, 2003</u>	Temperature :	<u>23°C</u>
EUT :	<u>PS2 2.4G RF Wireless Controller</u>	Humidity :	<u>58%</u>
Model No. :	<u>Controller: G7090</u>	Test Mode :	<u>Running</u>
Test Engineer:	<u>Sean Xing</u>		

<u>Channel.</u>	<u>Frequency</u>	<u>6dB Bandwidth</u>
<u>1</u>	<u>2.44000GHz</u>	<u>13.10MHz</u>

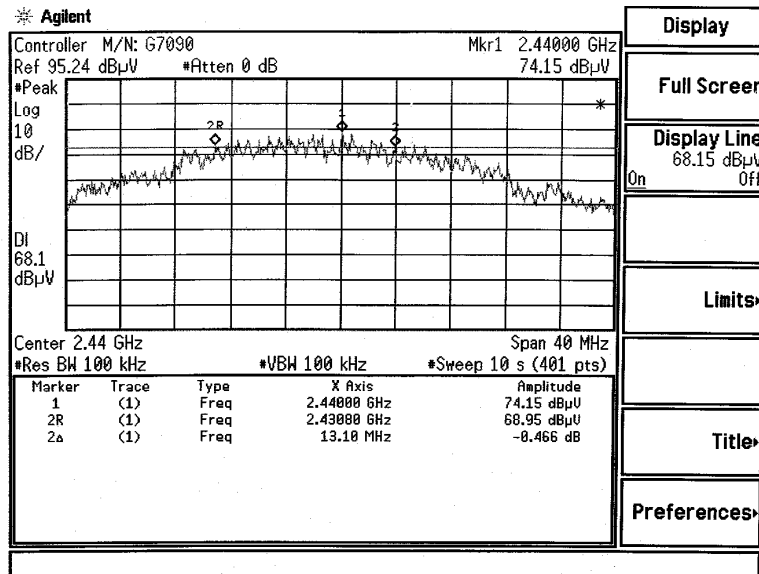
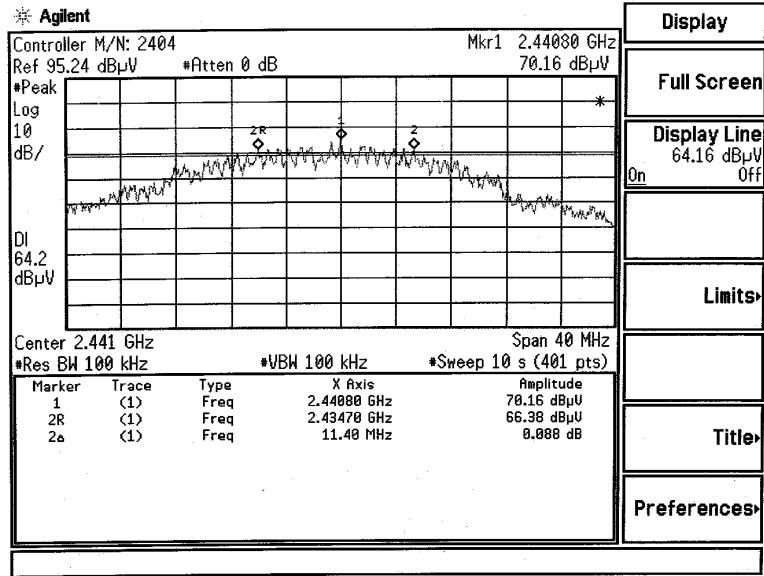

5. PEAK OUTPUT POWER MEASUREMENT

5.1. Test Equipment

The following test equipment were used during the Emission Bandwidth Test :

Item	Equipment	Manufacturer	Model No.	Serial No.	Last Cal.	Cal. Interval
1.	Spectrum	Agilent	E4407B	MY41440292	Mar.28, 03	1 Year
2.	Amp	HP	8449B	3008A00863	Jun.02, 02	1 Year
3.	Antenna	EMCO	3115	9607-4877	Dec. 04, 02	1.5 Year
4.	HF Cable	Hubersuhne	Sucoflex104	-	Jun.02, 02	1 Year
5.	Power meter	HP	436A	2016A07891	NCR	
6.	Power Sensor	HP	8481D	3318A13613	Jun.02, 02	1Year

5.2. Block Diagram of Test Setup

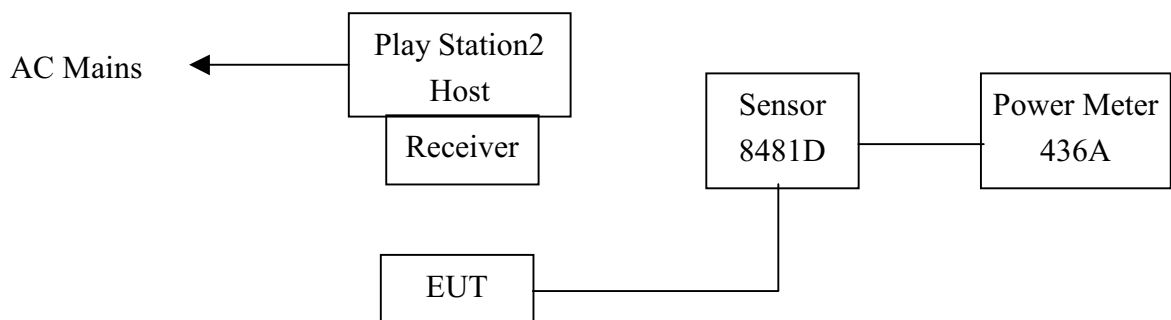

(EUT: PS2 2.4G RF Wireless Controller)

5.3. Specification Limits (§15.247(b)-(3))

The Limits of maximum Peak Output Power for digital modulation in 2400-2483.5MHz is : 1Watt. (30dBm)

5.4. Operating Condition of EUT

1. Setup the EUT as shown in Section 5.2..
2. Let the EUT work in test mode (Running) and test it.

5.5. Test Procedure

Setup the EUT as shown in Section 5.2. Turn on the play station 2 and let the EUT working . The EUT is via the power sensor link to power meter. The test value reading is from power meter.

5.6. Test Results

PASSED.

The testing data was attached in the next pages.

Date of Test : Apr. 23, 2003 Temperature : 23°C
 EUT : PS2 2.4G RF Wireless Controller Humidity : 58%
 Model No. : Controller: 2404 Test Mode : Running
 Test Engineer: Sean Xing

Frequency	Reading dBm	Cable Loss dBm	Poer Density dBm	Limit dBm
2440.0MHz	-25.77	0.2	-25.57	30.00

Date of Test : Apr. 23, 2003 Temperature : 23°C
 EUT : PS2 2.4G RF Wireless Controller Humidity : 58%
 Model No. : Controller: G7090 Test Mode : Running
 Test Engineer: Sean Xing

Frequency	Reading dB μ V	Cable Loss dBm	Poer Density dBm	Limit dBm
2440.0MHz	-25.18	0.2	-24.98	30.00

Reviewer:

Case Wang

6. BAND EDGES MEASUREMENT

6.1. Test Equipment

The following test equipment were used during the Emission Bandwidth Test :

Item	Equipment	Manufacturer	Model No.	Serial No.	Last Cal.	Cal. Interval
1.	Spectrum	Agilent	E4407B	MY41440292	Mar.28, 03	1 Year
2.	Amp	HP	8449B	3008A00863	Jun.02, 02	1 Year
3.	Antenna	EMCO	3115	9607-4877	Dec. 04, 02	1.5 Year
4.	HF Cable	Hubersuhne	Sucoflex104	-	Jun.02, 02	1 Year

6.2. Block Diagram of Test Setup

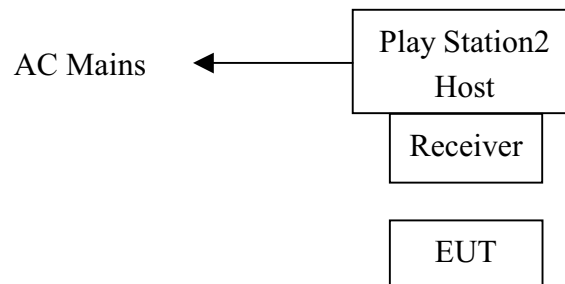

(EUT: PS2 2.4G RF Wireless Controller)

6.3. Specification Limits (§15.247(c))

The highest level should be at least 20 dB below that in the 100kHz bandwidth.

6.4. Operating Condition of EUT

1. Setup the EUT as shown in Section 6.2..
2. Let the EUT work in test mode (Running) and test it.

6.5. Test Procedure

EUT and its simulators are placed on a turn table, which is 0.8 meter high above ground. The turn table can rotate 360 degrees to determine the position of the maximum emission level. Power on the EUT and let it work normally, we use a keyboard test software, let EUT working in test mode, then test it. EUT is set 3 meters away from the receiving antenna, which is mounted on an antenna tower. The antenna can be moved up and down between 1 meter and 4 meters to find out the maximum emission level. Horn antenna is used as receiving antenna.

Set both RBW and VBW of spectrum analyzer to 100kHz with suitable frequency span including 100kHz bandwidth from band edge.

6.6. Test Results

PASSED.

The testing data was attached in the next pages.

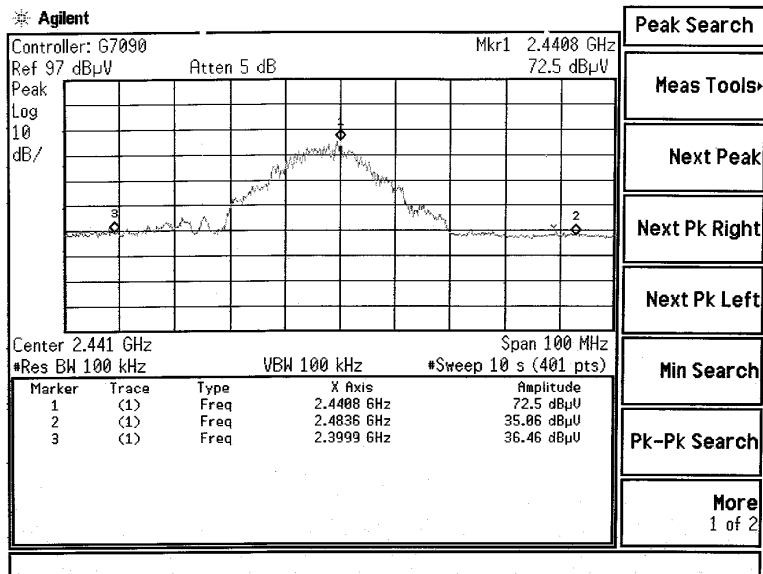
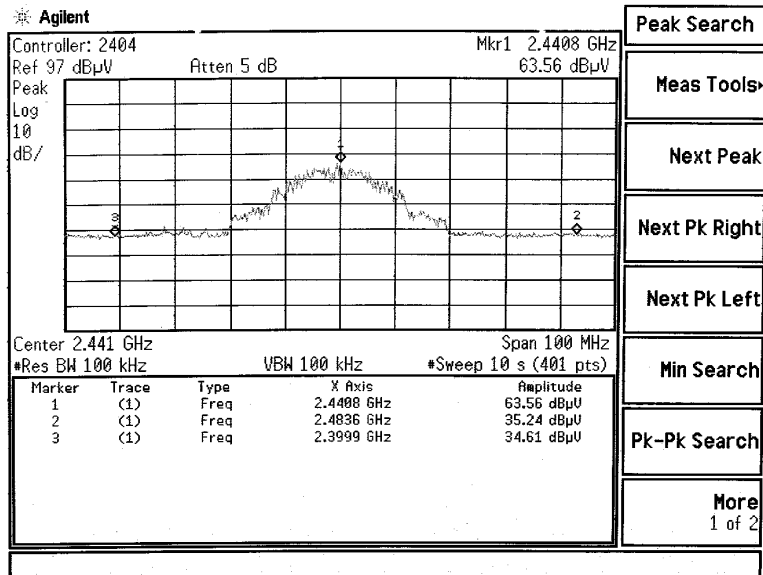

7. POWER SPECTRAL DENSITY MEASUREMENT

7.1. Test Equipment

The following test equipment were used during the Emission Bandwidth Test :

Item	Equipment	Manufacturer	Model No.	Serial No.	Last Cal.	Cal. Interval
1.	Spectrum	Agilent	E4407B	MY41440292	Mar.28, 03	1 Year
2.	Amp	HP	8449B	3008A00863	Jun.02, 02	1 Year
3.	Antenna	EMCO	3115	9607-4877	Dec. 04, 02	1.5 Year
4.	HF Cable	Hubersuhne	Sucoflex104	-	Jun.02, 02	1 Year

7.2. Block Diagram of Test Setup

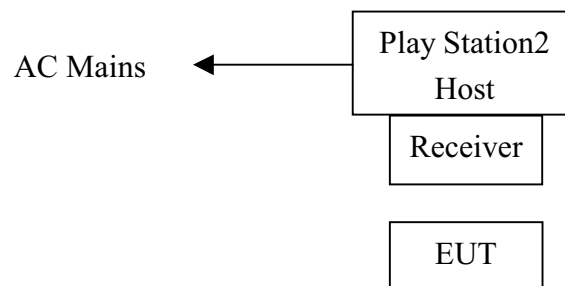

(EUT: PS2 2.4G RF Wireless Controller)

7.3. Specification Limits (§15.247(d))

The peak power spectral density conducted from the intentional radiator to the antenna shall not be greater than 8dBm in any 3kHz band.

7.4. Operating Condition of EUT

1. Setup the EUT as shown in Section 7.2..
2. Let the EUT work in test mode (Running) and test it.

7.5. Test Procedure

EUT and its simulators are placed on a turn table, which is 0.8 meter high above ground. Power on the EUT and let it work normally, we use a keyboard test soft ware, let EUT working in test mode, then test it. EUT is set 3 meters away from the receiving antenna, which is mounted on a antenna tower. The antenna can be moved up and down between 1 meter and 4 meters to find out the maximum emission level. Horn antenna is used as receiving antenna.

The bandwidth of the fundamental frequency was measured with the spectrum analyzer using 3kHz RBW and 30kHz VBW, set sweep time = span/3kHz.

7.6. Test Results

PASSED.

The testing data was attached in the next pages.

Date of Test : Apr. 23, 2003 Temperature : 23°C
 EUT : PS2 2.4G RF Wireless Controller Humidity : 58%
 Model No. : Controller: 2404 Test Mode : Running
 Test Engineer: Sean Xing

Frequency	Reading dB μ V	Poer Density dBm	Limit dBm
2439.9298MHz	65.73	-24.55	8.00

Remark:

Formulas used to calculate Power Density.

Using the relationship between field strength and RF power into an isotropic transmit antenna:

$$P(\text{Watts}) = (E(\text{V/m}) \times D: \text{meters})^2 / 30G \quad D = \text{Distance}$$

Antenna gain = -5dBi

$$G(\text{numeric}) = 10^{(G(\text{dBi})/10)} = 10^{(-5\text{dBi}/10)} = 0.32$$

$$65.73\text{dB}\mu\text{V} = 0.0019341938\text{V/m}$$

$$P(\text{Watt}) = (0.0019341938\text{V/m} \times 3\text{m})^2 / 9.6 = 3.5072865 \times 10^{-6}$$

$$10 * \log 3.5072865 \times 10^{-6} \times 10^3 = -24.55\text{dBm}$$

Date of Test : Apr. 23, 2003 Temperature : 23°C
 EUT : PS2 2.4G RF Wireless Controller Humidity : 58%
 Model No. : Controller: G7090 Test Mode : Running
 Test Engineer: Sean Xing

Frequency	Reading dB μ V	Poer Density dBm	Limit dBm
2440.0303MHz	68.91	-21.37	8.00

Remark:

Formulas used to calculate Power Density.

Using the relationship between field strength and RF power into an isotropic transmit antenna:

$$P(\text{Watts}) = (E(\text{V/m}) \times D: \text{meters})^2 / 30G \quad D = \text{Distance}$$

Antenna gain = -5dBi

$$G(\text{numeric}) = 10^{(G(\text{dBi})/10)} = 10^{(-5\text{dBi}/10)} = 0.32$$

$$68.91\text{dB}\mu\text{V} = 0.0027893306\text{V/m}$$

$$P(\text{Watt}) = (0.0027893306\text{V/m} \times 3\text{m})^2 / 9.6 = 7.2940923 \times 10^{-6}$$

$$10 * \log 7.2940923 \times 10^{-6} \times 10^3 = -21.37\text{dBm}$$

Reviewer:

Caife Wang

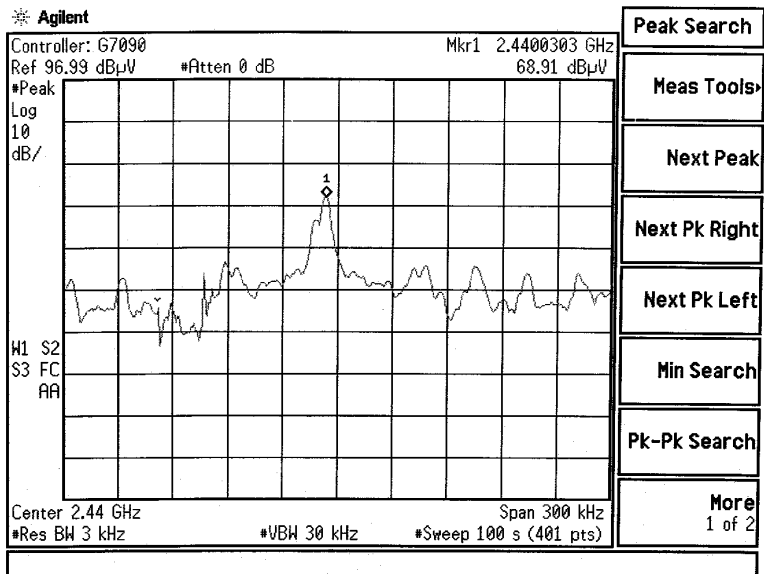
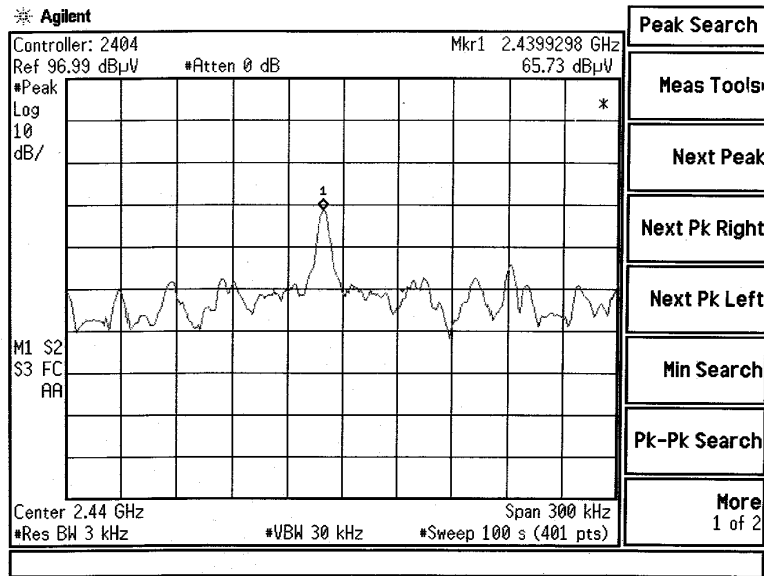

8. MAXIMUM PERMISSIBLE EXPOSURE

CALCULATIONS

Given

$$E = \sqrt{(30 * P * G) / d}$$

and

$$S = E^2 / 3770$$

where

E=Field Strength in Volts/meter

P=Power in Watts

G=Numeric antenna gain

d=distance in meters

S=Power Density in milliwatts/square centimeter

Combining equations and rearranging the terms to express the distance as a function of the remaining variables yields:

$$d = \sqrt{((30 * P * G) / (3770 * S))}$$

Changing to units of mW and cm, using:

$$P(\text{mW}) = P(\text{W}) / 1000 \text{ and}$$

$$d(\text{cm}) = 100 * d(\text{m})$$

yields

$$d = 100 * \sqrt{((30 * (P / 1000) * G) / (3770 * S))}$$

$$d = 0.282 * \sqrt{(P * G / S)}$$

where

d=distance in cm

P=Power in mW

G=Numeric antenna gain

S=Power Density in mW/cm²

Substituting the logarithmic form of power and gain using:

$$P(\text{mW}) = 10^{(P(\text{dBm}) / 10)} \text{ and}$$

$$G(\text{numeric}) = 10^{(G(\text{dBi}) / 10)}$$

yields

$$d = 0.282 * 10^{((P+G) / 20)} / \sqrt{s} \quad \text{Equation(1)}$$

where

d=MPE safe distance in cm

P=Power in dBm

G=Antenna Gain in dBi

S=Power Density Limit in mW/cm²

RESULTS

No non-compliance noted:

MAXIMUM PERMISSIBLE EXPOSURE (2.4GHZ BAND)

EUT output power = -24.98 dBm

Antenna Gain = -5dBi

S = 1.0mW / cm² from 1.1310 Table 1

Substituting these parameters into Equation (1) above:

MPE Safe Distance = 0.009 cm

9. DEVIATION TO TEST SPECIFICATIONS

(None.)

APPENDIX I



AUDIX TECHNOLOGY (SHENZHEN) CO., LTD.

Shenzhen Science & Ind Park
 Tel:0755-26639496
 Fax:26632877

Data#: 43 File#: Vision.EMI Date: 2003-04-22 Time: 20:03:24

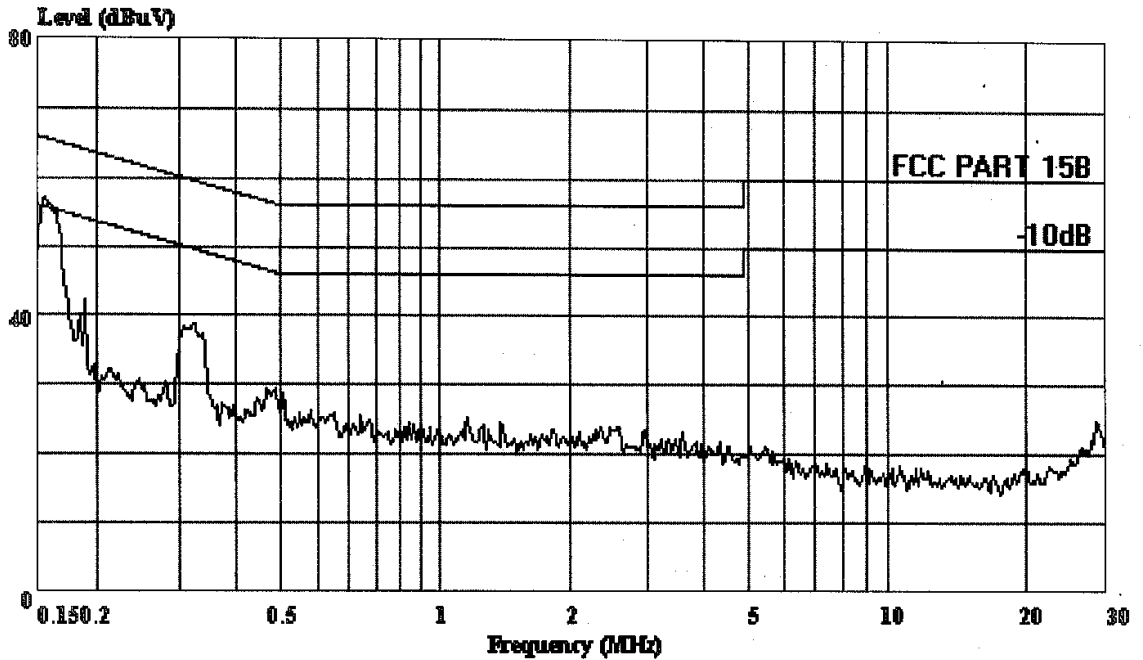

AUDIX TECHNOLOGY (SHENZHEN) CO., LTD. (Audix ATC)

Trace:

Ref Trace:

Condition: FCC PART 15B VA(KNW-407)
 EUT : PS2 2.4G RF Wireless Controller
 M/N : Controller: 2404, Receiver: 2474
 OP Cond : Running
 Test Spec : 120V/60Hz, DC 6V
 Test Engineer: Sean Xing
 Comment : Temp:24.6'C Humi:54%



AUDIX TECHNOLOGY (SHENZHEN) CO., LTD.

Shenzhen Science & Ind Park
 Tel:0755-26639496
 Fax:26632877

Data#: 41 File#: Vision.EMI Date: 2003-04-22 Time: 19:36:42

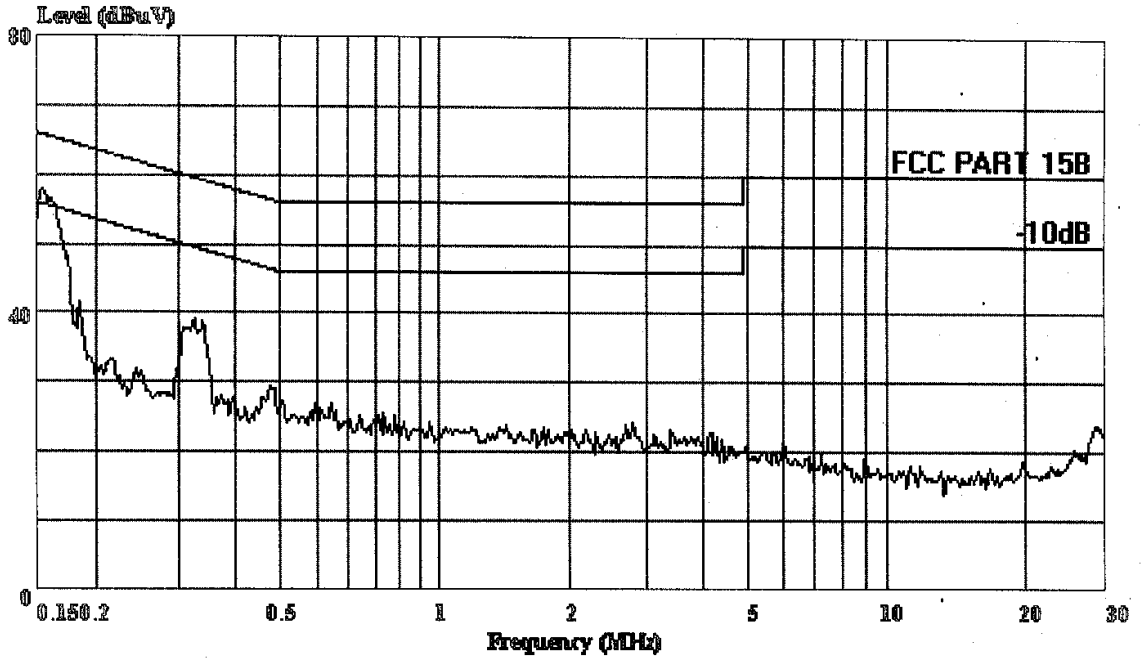

AUDIX TECHNOLOGY (SHENZHEN) CO., LTD. (Audix ATC)

Trace:

Ref Trace:

Condition: FCC PART 15B VB(KNW-407)
 EUT : PS2 2.4G RF Wireless Controller
 M/N : Controller: 2404, Receiver: 2474
 OP Cond : Running
 Test Spec : 120V/60Hz, DC 6V
 Test Engineer: Sean Xing
 Comment : Temp:24.6'C Humi:54%



AUDIX TECHNOLOGY (SHENZHEN) CO., LTD.

Shenzhen Science & Ind Park
 Tel:0755-26639496
 Fax:26632877

Data#: 37 File#: Vision.EMI Date: 2003-04-22 Time: 18:41:08

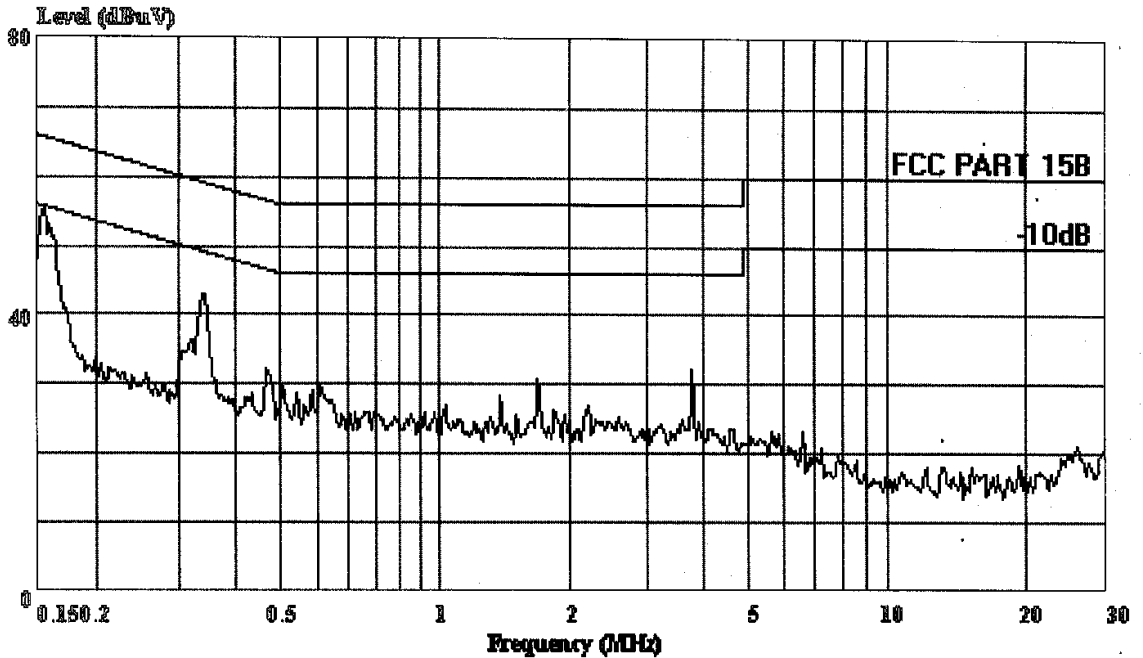

AUDIX TECHNOLOGY (SHENZHEN) CO., LTD. (Audix ATC)

Trace:

Ref Trace:

Condition: FCC PART 15B VA(KNW-407)
 EUT : PS2 2.4G RF Wireless Controller
 M/N : Controller: G7090, Receiver: 2476
 OP Cond : Running
 Test Spec : 120V/60Hz, DC 3V
 Test Engineer: Sean Xing
 Comment : Temp:24.6'C Humi:54%



AUDIX TECHNOLOGY (SHENZHEN) CO., LTD.

Shenzhen Science & Ind Park
 Tel:0755-26639496
 Fax:26632877

Data#: 39 File#: Vision.EMI Date: 2003-04-22 Time: 18:58:41

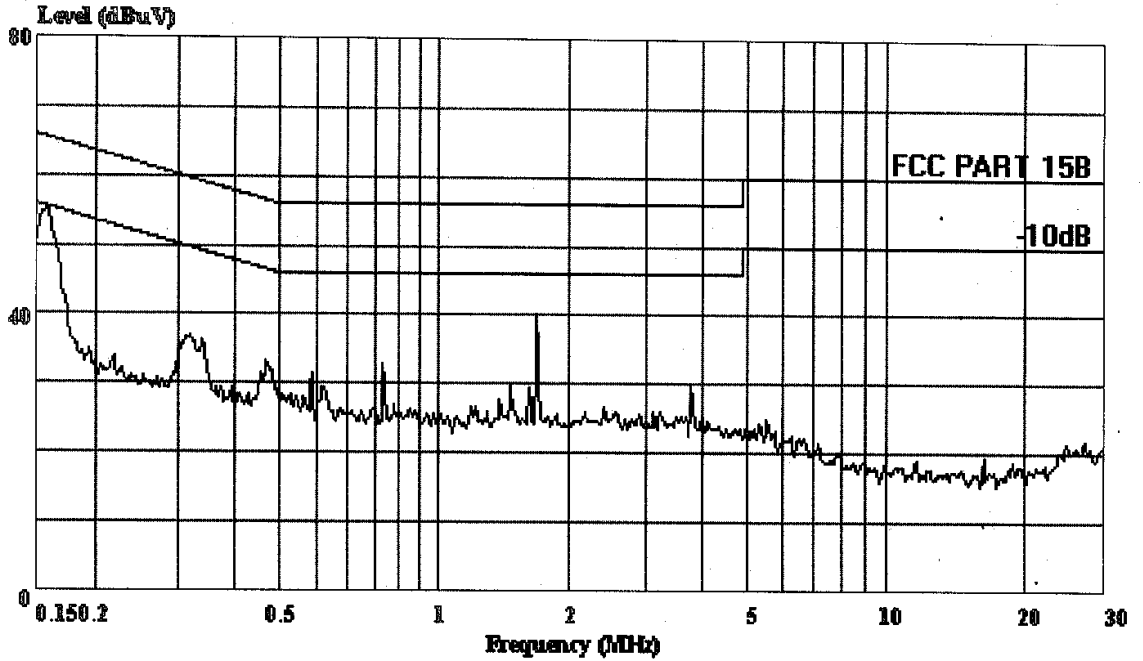

AUDIX TECHNOLOGY (SHENZHEN) CO., LTD. (Audix ATC)

Trace:

Ref Trace:

Condition: FCC PART 15B VB(KNW-407)
 EUT : PS2 2.4G RF Wireless Controller
 M/N : Controller: G7090, Receiver: 2476
 OP Cond : Running
 Test Spec : 120V/60Hz, DC 3V
 Test Engineer: Sean Xing
 Comment : Temp:24.6'C Humi:54%

APPENDIX II



AUDIX TECHNOLOGY (SHENZHEN) CO., LTD.

Shenzhen Science & Ind. Park
 Tel: 0755-26639495~7
 Fax: 0755-26632877

Data#: 9 File#: Vision.EMI Date: 2003-04-23 Time: 22:10:38

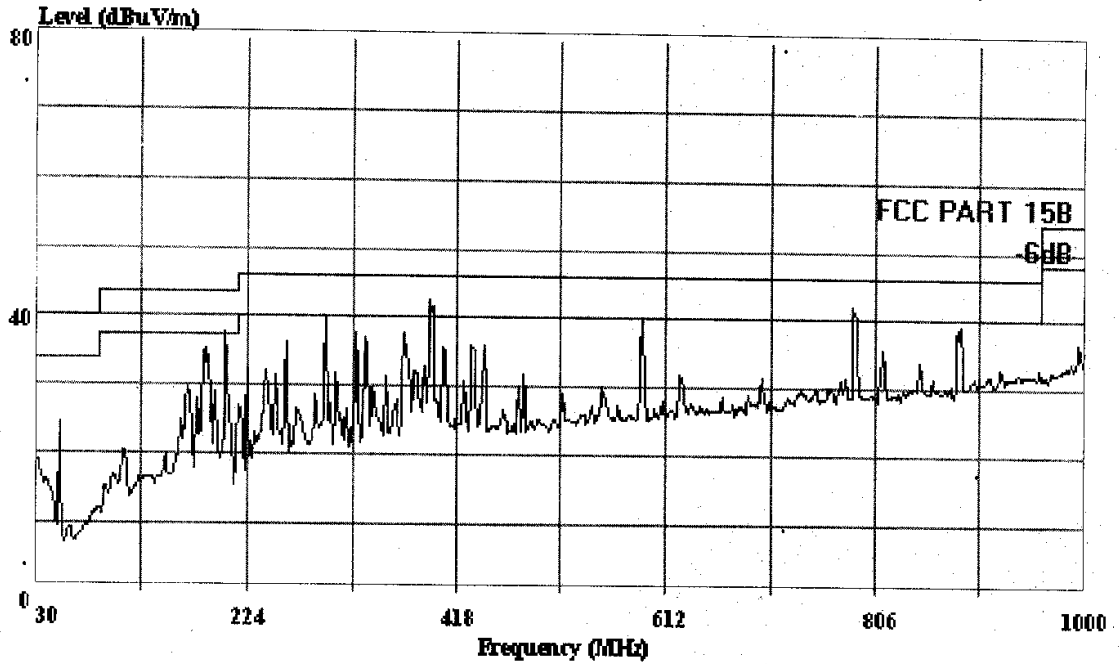

AUDIX TECHNOLOGY (SHENZHEN) CO., LTD. (3# Chamber)

Trace:

Ref Trace:

Condition: FCC PART 15B 3m 2598FACTOR HORIZONTAL
 EUT : PS2 2.4G RF Wireless Controller
 M/N : Controller: 2404. Receiver: 2474
 Power : Host 120V/60Hz DC 6V
 Test Engineer: Sean Xing
 Comment : Temp: 23' C Humi: 58%
 Memo : Running



AUDIX TECHNOLOGY (SHENZHEN) CO., LTD.

Shenzhen Science & Ind. Park
 Tel: 0755-26639495~7
 Fax: 0755-26632877

Data#: 11 File#: Vision.EMI Date: 2003-04-23 Time: 22:30:42

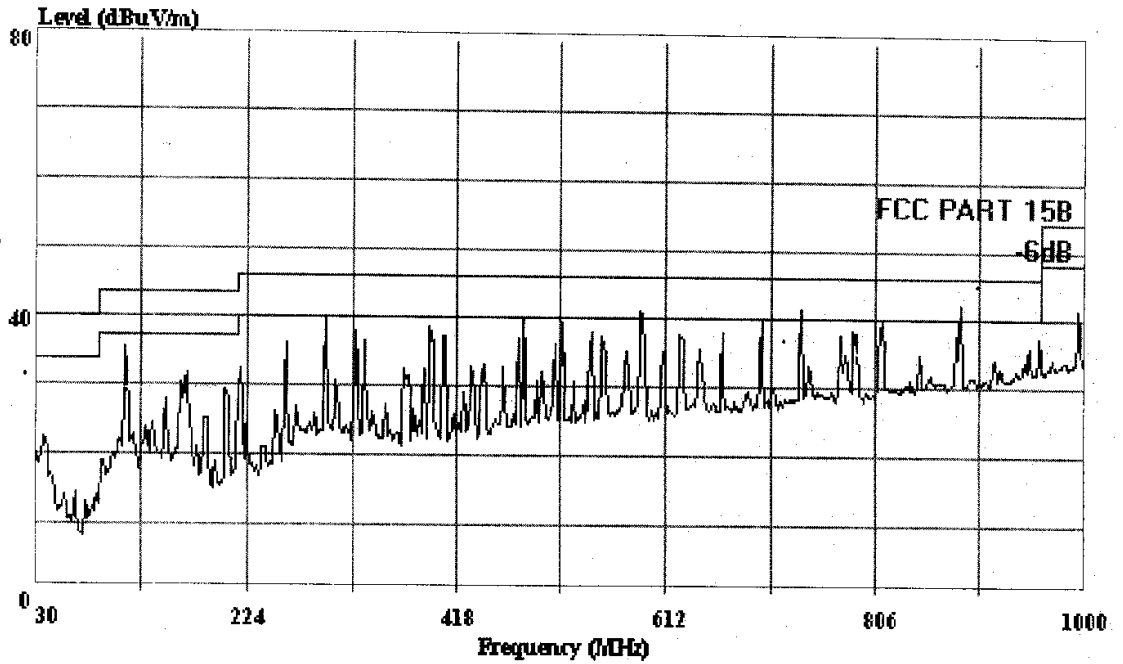

AUDIX TECHNOLOGY (SHENZHEN) CO., LTD. (3# Chamber)

Trace:

Ref Trace:

Condition: FCC PART 15B 3m 2598FACTOR VERTICAL
 EUT : PS2 2.4G RF Wireless Controller
 M/N : Controller: 2404. Receiver: 2474
 Power : Host 120V/60Hz DC 6V
 Test Engineer: Sean Xing
 Comment : Temp: 23' C, Humi: 28%
 Memo : Running



AUDIX TECHNOLOGY (SHENZHEN) CO., LTD.

Shenzhen Science & Ind. Park
 Tel: 0755-26639495~7
 Fax: 0755-26632877

Data#: 15 File#: Vision.EMI Date: 2003-04-23 Time: 23:10:50

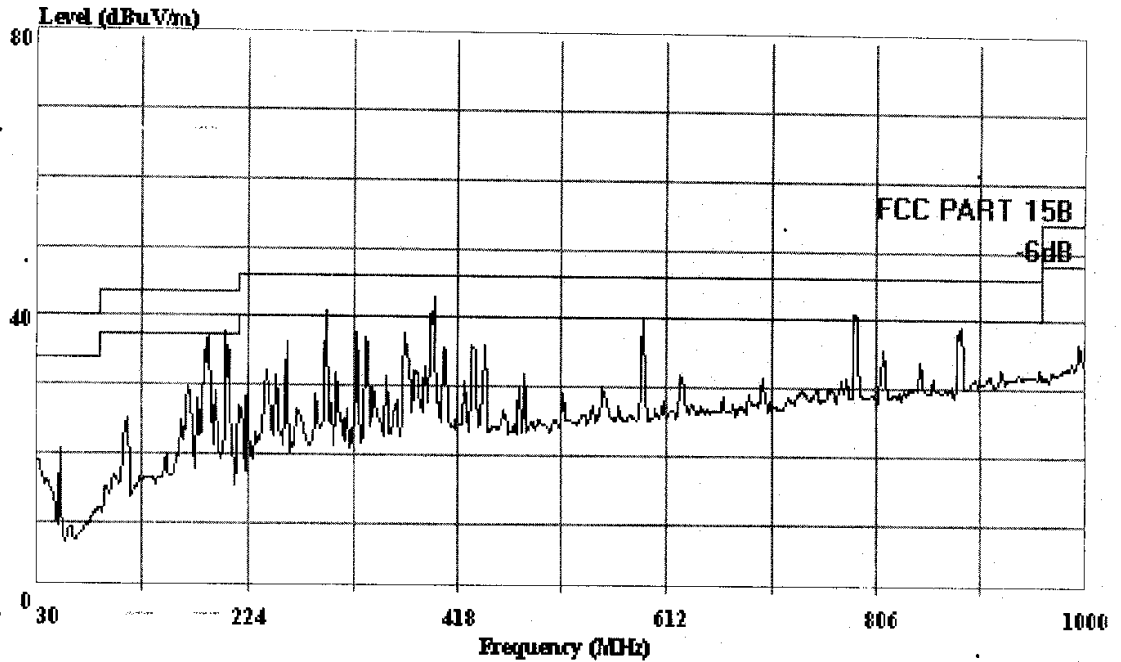

AUDIX TECHNOLOGY (SHENZHEN) CO., LTD. (3# Chamber)

Trace:

Ref Trace:

Condition: FCC PART 15B 3m 2598FACTOR HORIZONTAL
 EUT : PS2 2.4G RF Wireless Controller
 M/N : Controller: G7090. Receiver: 2476
 Power : Host 120V/60Hz DC 3V
 Test Engineer: Sean Xing
 Comment : Temp: 23' C Humi: 58%
 Memo : Running



AUDIX TECHNOLOGY (SHENZHEN) CO., LTD.

 Shenzhen Science & Ind. Park
 Tel: 0755-26639495~7
 Fax: 0755-26632877

Data#: 13 File#: Vision.EMI

Date: 2003-04-23 Time: 22:50:25

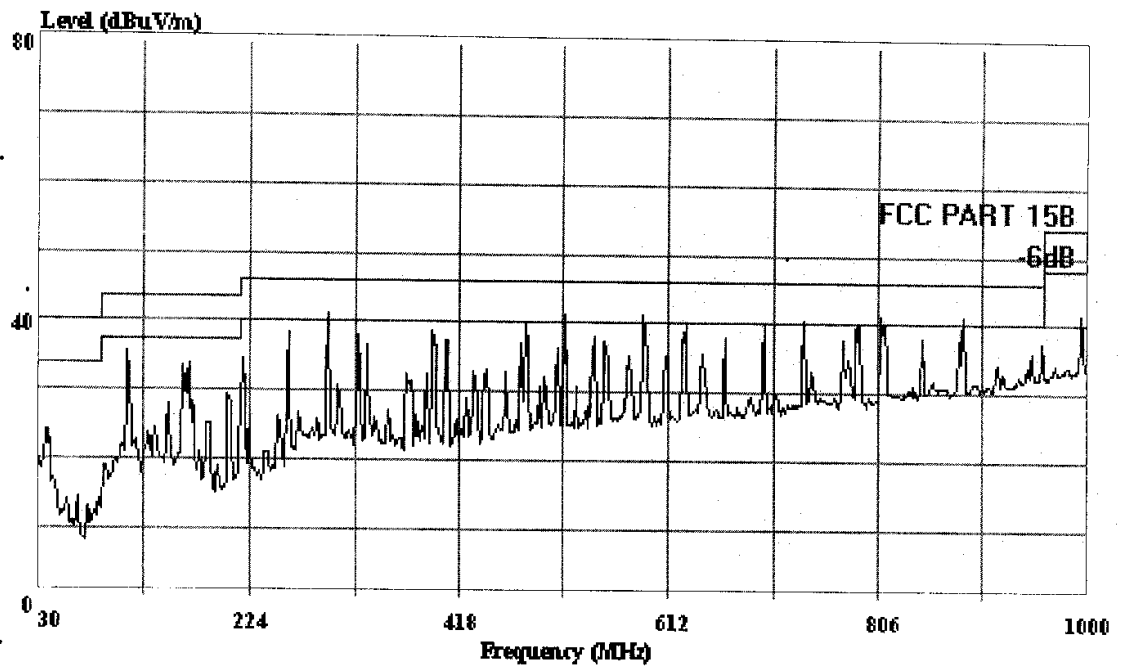

AUDIX TECHNOLOGY (SHENZHEN) CO., LTD. (3# Chamber)

Trace:

Ref Trace:

Condition: FCC PART 15B 3m 2598FACTOR VERTICAL
 EUT : PS2 2.4G RF Wireless Controller
 M/N : Controller: G7090. Receiver: 2476
 Power : Host 120V/60Hz DC 3V
 Test Engineer: Sean Xing
 Comment : Temp: 23' C, Humi: 28%
 Memo : Running



信華科技(深圳)有限公司

AUDIX Technology (Shenzhen) Co., Ltd.

No. 6, Ke Feng Road, Block 52,
Shenzhen Science & Industry Park
Nantou, Shenzhen, Guangdong, China
Tel: +86-755-26639496 Fax: +86-755-26632877

Data#: 10 File#: C:\EMI TEST DATA\V\Vision.EMI

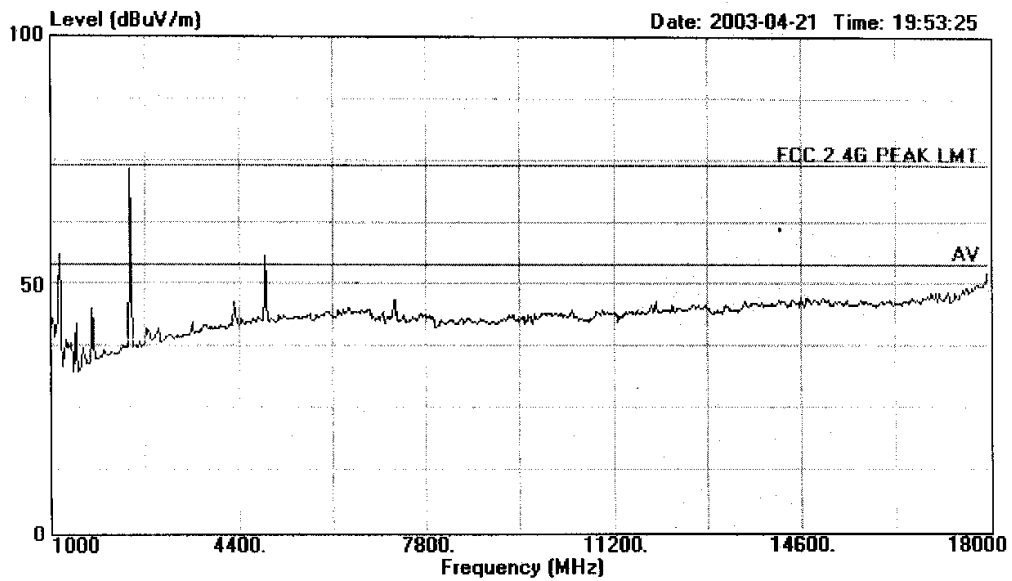

Site : 1# Chamber
Condition : FCC 2.4G PEAK LMT 3m 3115FACTOR HORIZONTAL
EUT : PS2 2.4G RF Wireless Controller
M/N : Controller 2404
Power : DC 6V
Test Engineer : Sean Xing
Memo : Running



信華科技(深圳)有限公司

AUDIX Technology (Shenzhen) Co., Ltd.

No. 6, Ke Feng Road, Block 52,
Shenzhen Science & Industry Park
Nantou, Shenzhen, Guangdong, China
Tel: +86-755-26639496 Fax: +86-755-26632877

Data#: 11 File#: C:\EMI TEST DATA\V\Vision.EMI

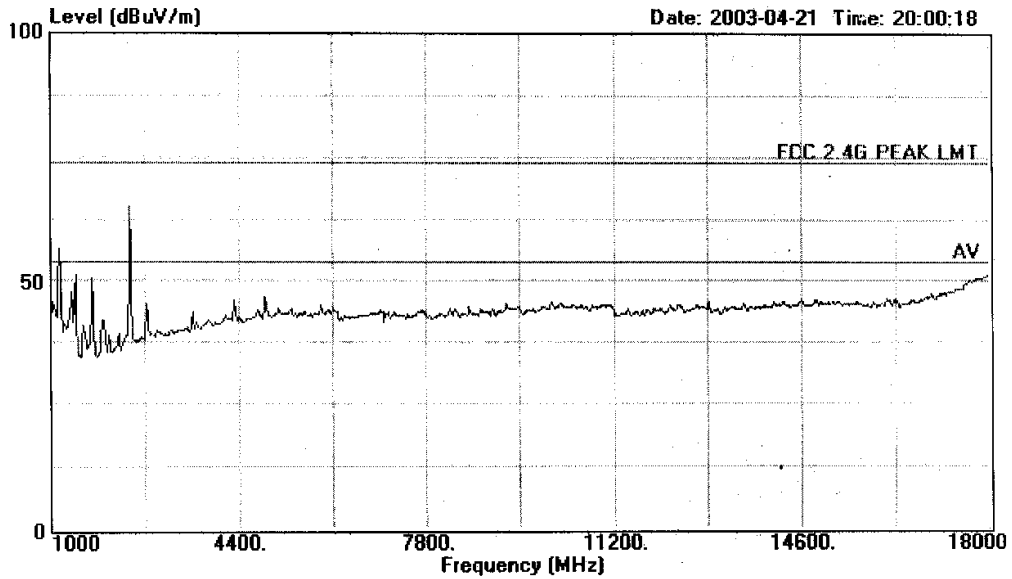

Site : 1# Chamber
Condition : FCC 2.4G PEAK LMT 3m 3115FACTOR VERTICAL
EUT : PS2 2.4G RF Wireless Controller
M/N : Controller 2404
Power : DC 6V
Test Engineer : Sean Xing
Memo : Running



信華科技(深圳)有限公司

AUDIX Technology (Shenzhen) Co., Ltd.

No. 6, Ke Feng Road, Block 52,
Shenzhen Science & Industry Park
Nantou, Shenzhen, Guangdong, China
Tel:+86-755-26639496 Fax:+86-755-26632877

Data#: 17 File#: C:\EMI TEST DATA\Vision.EMI

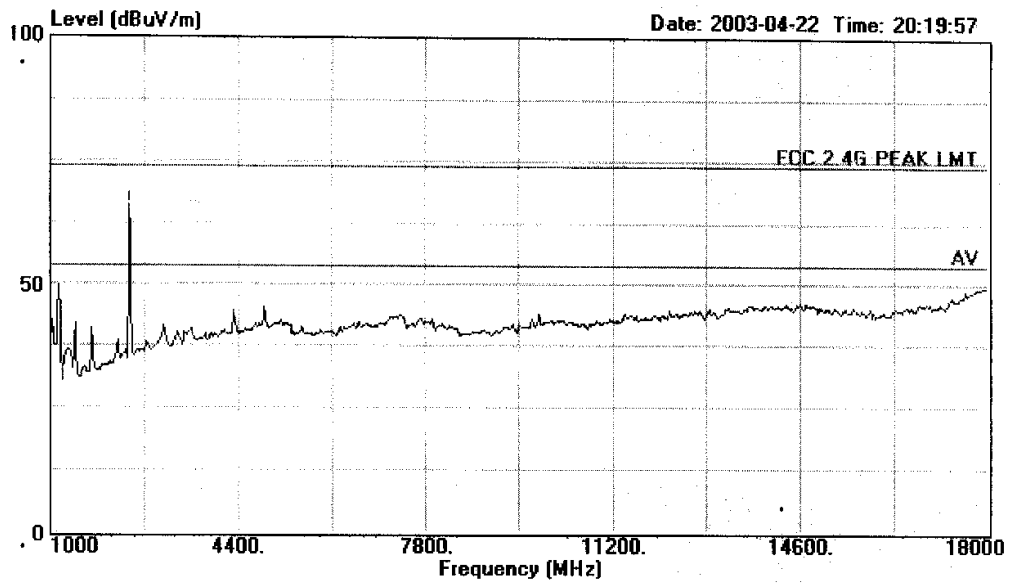

Site : 1# Chamber
Condition : FCC 2.4G PEAK LMT 3m 3115FACTOR HORIZONTAL
EUT : PS2 2.4G RF Wireless Controller
M/N : Controller G7090
Power : DC 3V
Test Engineer : Sean Xing
Memo : Running



信華科技(深圳)有限公司

AUDIX Technology (Shenzhen) Co., Ltd.

No. 6, Ke Feng Road, Block 52,
Shenzhen Science & Industry Park
Nantou, Shenzhen, Guangdong, China
Tel:+86-755-26639496 Fax:+86-755-26632877

Data#: 8 File#: C:\EMI TEST DATA\V\Vision.EMI

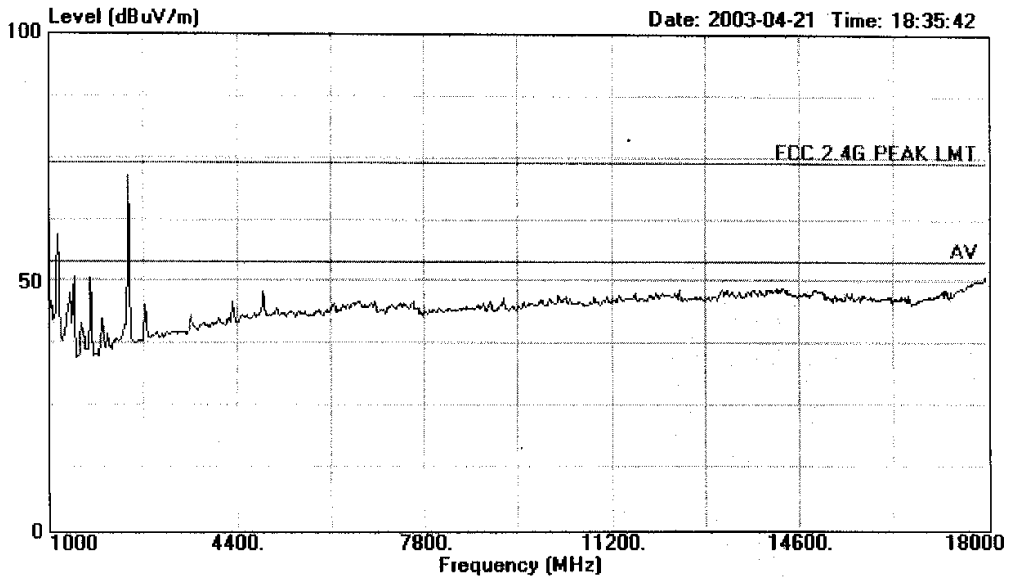

Site : 1# Chamber
Condition : FCC 2.4G PEAK LMT 3m 3115FACTOR VERTICAL
EUT : PS2 2.4G RF Wireless Controller
M/N : Controller G7090
Power : DC 3V
Test Engineer : Sean Xing
Memo : Running



信華科技(深圳)有限公司

AUDIX Technology (Shenzhen) Co., Ltd.

No. 6, Ke Feng Road, Block 52,
 Shenzhen Science & Industry Park
 Nantou, Shenzhen, Guangdong, China
 Tel:+86-755-26639496 Fax:+86-755-26632877

Data#: 65 File#: C:\EMI TEST DATA\Vision.EMI

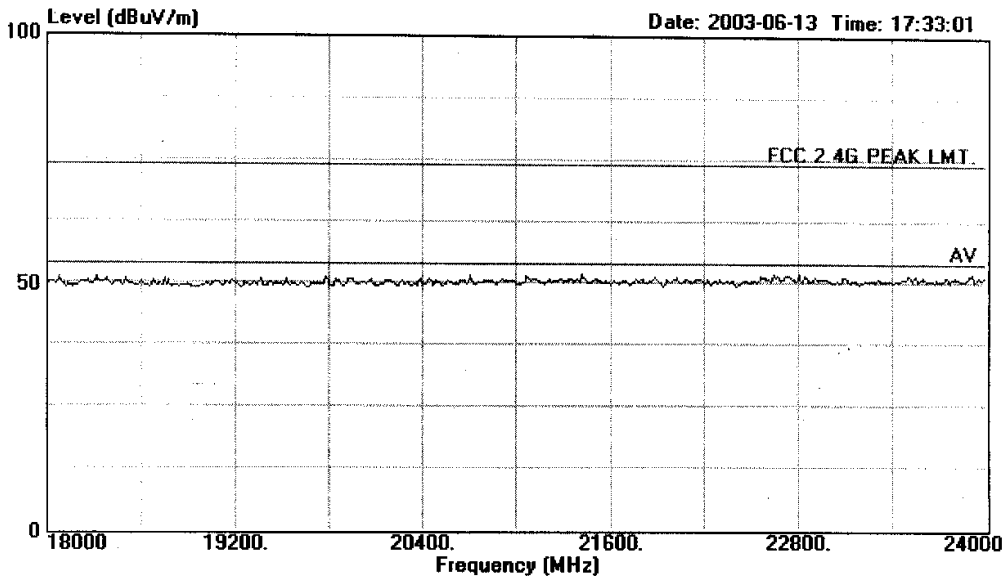

Site : 1# Chamber
 Condition : FCC 2.4G PEAK LMT. 3m 3115FACTOR HORIZONTAL
 EUT : PS2 2.4G RF Wireless Controller
 M/N : Controller 2404
 Power : DC 6V
 Test Engineer : Sean Xing
 Memo : Running



信華科技(深圳)有限公司

AUDIX Technology (Shenzhen) Co., Ltd.

No. 6, Ke Feng Road, Block 52,
Shenzhen Science & Industry Park
Nantou, Shenzhen, Guangdong, China
Tel:+86-755-26639496 Fax:+86-755-26632877

Data#: 64 File#: C:\EMI TEST DATA\Vision.EMI

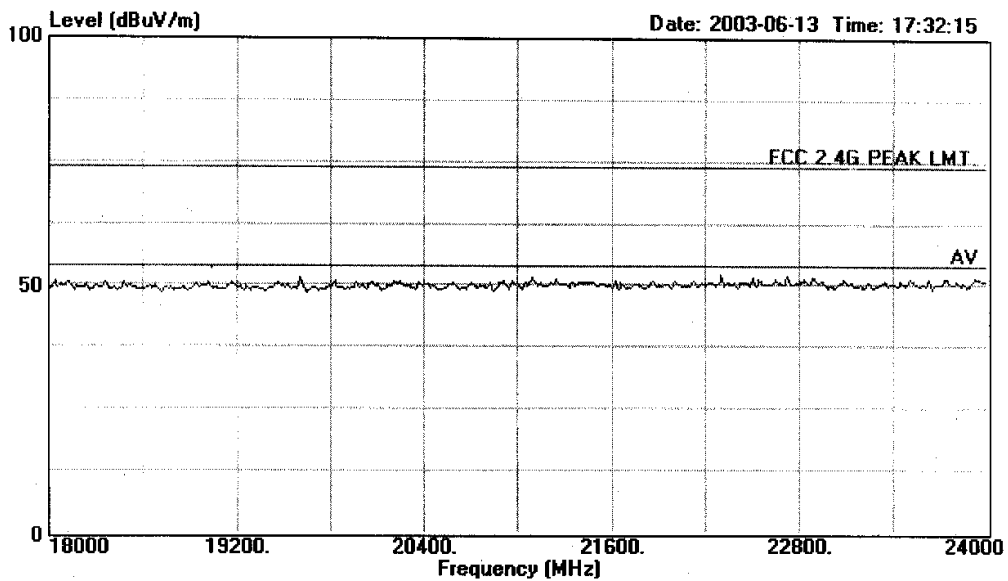

Site : i# Chamber
Condition : FCC 2.4G PEAK LMT. 3m 3115FACTOR VERTICAL
EUT : PS2 2.4G RF Wireless Controller
M/N : Controller 2404
Power : DC 6V
Test Engineer : Sean King
Memo : Running



信華科技(深圳)有限公司

AUDIX Technology (Shenzhen) Co., Ltd.

No. 6, Ke Feng Road, Block 52,
Shenzhen Science & Industry Park
Nantou, Shenzhen, Guangdong, China
Tel:+86-755-26639496 Fax:+86-755-26632877

Data#: 66 File#: C:\EMI TEST DATA\V\Vision.EMI

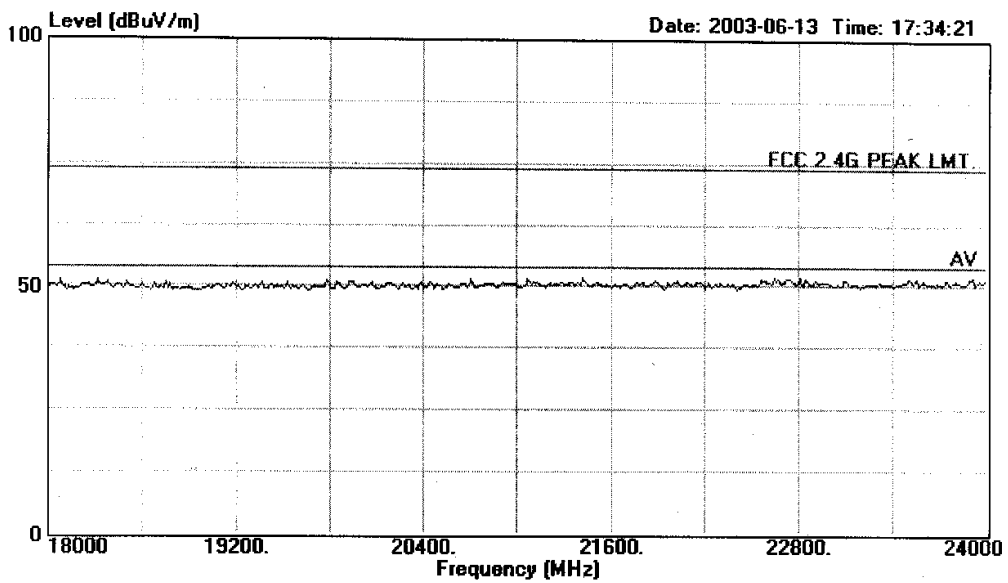

Site : 1# Chamber
Condition : FCC 2.4G PEAK LMT. 3m 3115FACTOR HORIZONTAL
EUT : PS2 2.4G RF Wireless Controller
M/N : Controller G7090
Power : DC 3V
Test Engineer : Sean King
Memo : Running



信華科技(深圳)有限公司

AUDIX Technology (Shenzhen) Co., Ltd.

No. 6, Ke Feng Road, Block 52,
 Shenzhen Science & Industry Park
 Nantou, Shenzhen, Guangdong, China
 Tel:+86-755-26639496 Fax:+86-755-26632877

Data#: 67 File#: C:\EMI TEST DATA\Vision.EMI

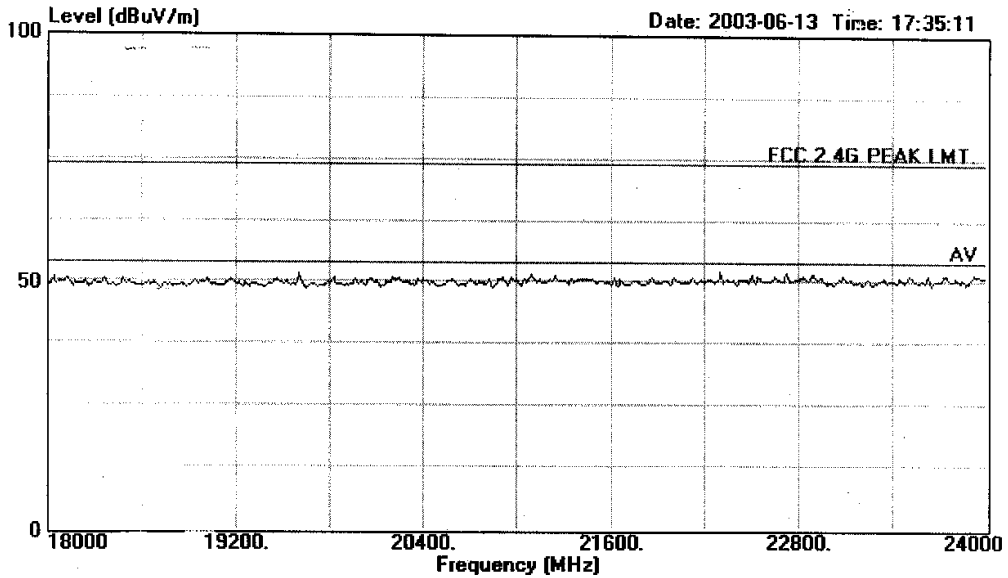

Site : 1# Chamber
 Condition : FCC 2.4G PEAK LMT. 3m 3115FACTOR VERTICAL
 EUT : PS2 2.4G RF Wireless Controller
 M/N : Controller G7090
 Power : DC 3V
 Test Engineer : Sean Xing
 Memo : Running